

APPLITEC

SWISS TOOLING

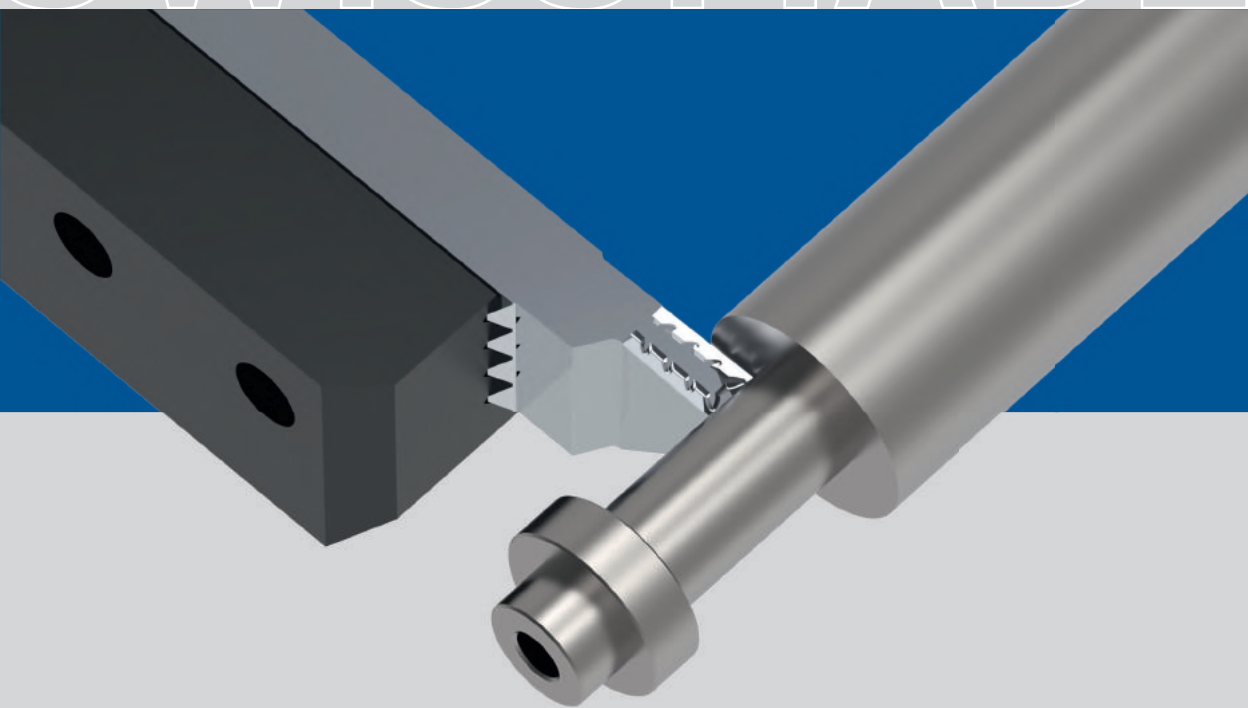

SWISSMADE



EDITION 2022-2024

APPLITEC

**OUTILS DE HAUTES PERFORMANCES
POUR LE DÉCOLLETAGE
ET LA MICROMÉCANIQUE**

**HOCHLEISTUNGSWERKZEUGE
FÜR DREHAUTOMATEN
UND MIKROMECHANIK**

**HIGH PERFORMANCE TOOLING
FOR AUTOMATIC LATHES
AND MICROMECHANICS**



	TOP-LINE		1
	TOP-WATCH		2
	PRO-LINE		3
	ECO-LINE		4
	TRIO-LINE		5
	TURN-LINE		6
	ISO-LINE		7
	EVOCUT-LINE		8
	CUT-LINE		9
	IN-LINE		10
	SWITCH-LINE	new	11
	MODU-LINE		12
	TOOLING-LINE		13
	MICRO-LINE		14
	CIRCO-LINE		15
	JET-LINE	new	16
	INDEX		17

APPLITEC



INFO

Nuances et paramètres de coupe
Sorten und Schnittwerte
Grades and machining data

> **1.02****710 / 720**

Pour machines à cames
Für kurvengesteuerte Maschinen
For cam driven machines

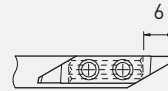
> **1.12****730 / 740**

Main series
Small type

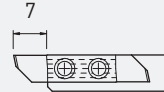
> **1.24****750 / 760**

Main series
Large type

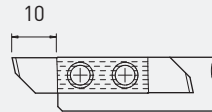
> **1.68****770 / 780****7050 / 7060****W750 / W760****POLYGONAL
INTERFACE****HSK****740Z / 760Z****TORNOS****SCHÜTTE**

Tronçonnage de grande capacité et ébauches larges pour
profilage + porte-outils spéciaux

Abstechen für grössere Durchmesser und breite Rohlinge
für Profilschleifen + Sonderwerkzeughalter

High capacity parting off and wide blanks for profiling +
special tool holders

> **1.132**

Pièces de rechange
Ersatzteile
Spare parts

> **1.166**

TOP-LINE

Codification des plaquettes TOP-Line série 700

WSP-Bezeichnungssystem für TOP-Line 700 Serie

Inserts designation key for TOP-Line 700 series



Dimension
Abmessung
Dimension

Rayon
Radius
Radius

Nuance
Sorte
Grade

Géométrie de coupe / Brise-copeaux / Particularités
 Schneidgeometrie / Spanbrecher / Sondereigenschaften
 Cutting geometry / Chip breaker / Special features

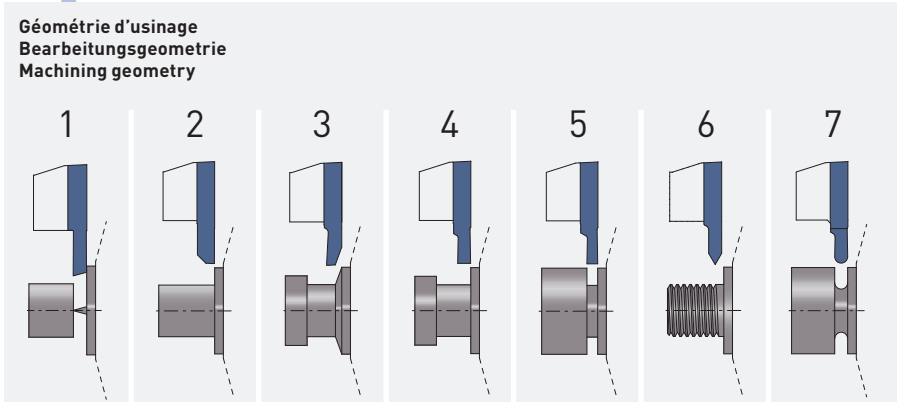

Gamme de produit
 Produktserie
 Product series

définit la compatibilité des plaquettes avec le porte-outil
 bestimmt die WSP und Halter Kompatibilität
 shows the inserts and holder compatibility

L = 1, 3, 5, 7 (chiffre impair / ungerade Zahl / uneven number)

R = 2, 4, 6, 8 (chiffre pair / gerade Zahl / even number)

L 710 | R 720

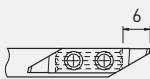

pour machines à cames
 für kurvengesteuerte Maschinen
 for cam driven machines

L 730 | R 740

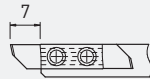

main series
 small type

L 750 | R 760

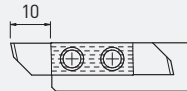

main series
 large type

L 770 | R 780

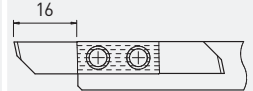

tronçonnage uniquement
 nur für abstechen
 only for parting off

Applitec série 700
 Applitec 700 Serie
 Applitec 700 series

Système de serrage à denture décalée avec 2 vis de fixation
 Spannsystem mit 2 Schrauben und verschobener Verzahnung
 Shifted teeth clamping system with 2 screws

L'outil de référence pour le décolletage

Hochwertiges Wendeplattensystem für Langdrehautomaten

Top class turning tool for automatic lathes

700 Series

100% rigid!

Système de serrage Applitec à denture décalée
 Applitec-Spannsystem mit verschobener Verzahnung
 Applitec clamping system with shifted teeth

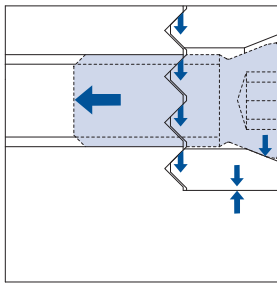
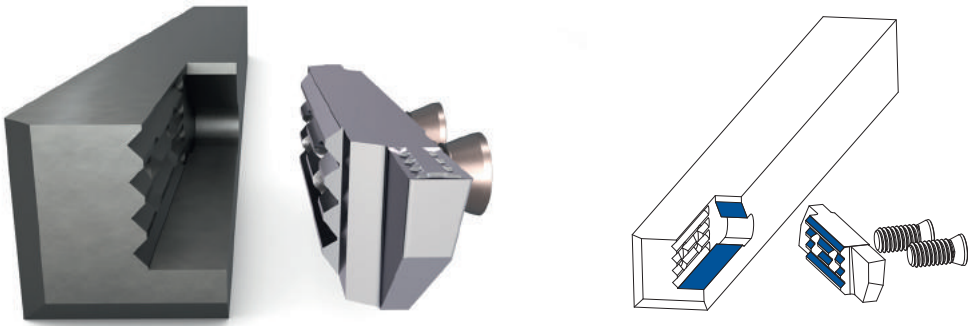

Serrage standard (A)
Standard Spannsystem (A)
Standard clamping system (A)

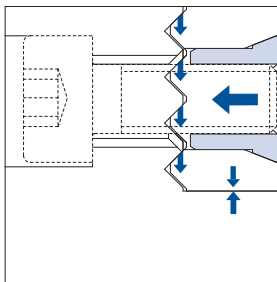
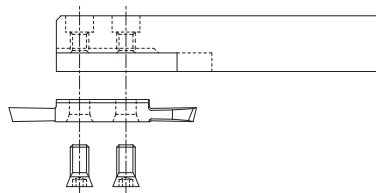

Serrage type B*
Spannsystem Typ B*
Clamping system type B*

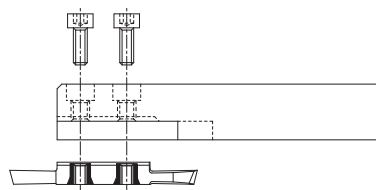

ajouter -B après le numéro d'article
 -B nach der Artikelreferenz hinzufügen
 add -B after the article number

Changement de la plaquette possible dans la machine, sans démontage du porte-outil
 WSP-Austauschmöglichkeit in der Maschine ohne Halterausbau
 The insert can be changed in the machine without removing the tool holder

700-ZX geometries

Très bonne maîtrise du copeau
pour matières difficiles

Sehr gute Spankontrolle für
schwierige Werkstoffe

Very efficient chip control for
difficult materials



Multitude de géométries possibles

Mehrere mögliche Spangeometrien

Many different cutting geometries are possible

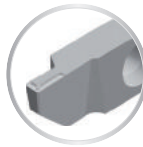

700-honed



Géométrie positive 5° avec arête de coupe renforcée (honnée)
Meilleure durée de vie dans l'usinage des matériaux abrasifs (aciers au carbone, aciers alliés)

Positive Geometrie 5° mit verstärkte Schneidkante (gehont)
Bessere Standzeit für die Bearbeitung von abrasive Materialien (Kohlenstoff Stahl, legierter Stahl)

Positive geometry 5° with reinforced cutting edge (honed)
Better tool life for abrasive materials (carbon steel, alloy steel)

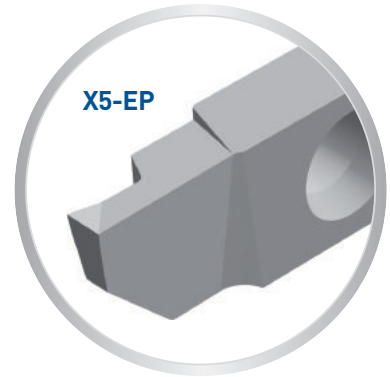





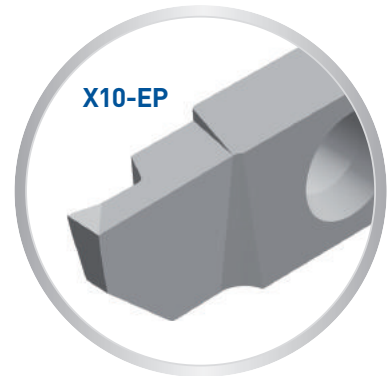

Géométrie positive 10° avec arête de coupe renforcée (honnée)
Meilleure durée de vie dans l'usinage des matériaux tenace (acier inox, inox martensitique)

Positive Geometrie 10° mit verstärkte Schneidkante (gehont)
Bessere Standzeit für die Bearbeitung von zähe Materialien (Rostfreier Stahl, martensitische Rostfreier Stahl)

Positive geometry 10° with reinforced cutting edge (honed)
Better tool life for tough materials (stainless steel, martensitic steel)



Géométries de coupe Spanformgeometrien Cutting geometries		Acier de décolletage Automatenstahl Free-cutting steel	Acier Stahl Steel	Acier inoxydable Rostfreistahl Stainless steel	Aluminium	Titane Titan Titanium	Laiton, bronze Messing, Bronze Brass, bronze	Cuivre Kupfer Copper	★	1 ^{er} choix 1. Wahl 1 st choice
									☆	Recommandé Empfohlen Recommended
								☑	Pour pièces fragiles de très petits diamètres Für empfindliche und sehr kleine Werkstücke For fragile and very small work pieces	
	0°	★	☑	☑	☑	☑	★	☑	Permet un réaffûtage aisé Erlaubt einfaches Nachschleifen Allows easy regrinding	
	X4°	★	★	★	☑	☑		☑	Réduit l'effort de coupe, réaffûtable Reduziert Schneidkräfte, nachschleifbar Decreases cutting force, allows regrinding	
	XF	☆	★	★				☆	Pour matières difficiles (pointe renforcée) Für schwierige Werkstoffe (verstärkte Spitze) For difficult materials (reinforced point)	
	X12°			☆	★	★		★	Très bonne maîtrise du copeau Sehr gute Spankontrolle Very efficient chip control	
	X25°			☆	★	☆		☆	Pour matières collantes faisant de très longs copeaux Für klebrige Werkstoffe mit sehr langen Spänen For long chipping sticky materials	
	U	☆	☆	☆					Pour resserrer le copeau, réaffûtage aisé Für Spanversmälnerung, einfaches Nachschleifen To narrow the chips, easy regrinding	
	ZU8	★	★	★	☆ <5% Si	☆	☆		Très bonne maîtrise du copeau (arête de coupe honée) Sehr gute Spankontrolle (gehonte Schneidkante) Very efficient chip control (honed edge) f min: 0.02 mm/U	

Conseils d'utilisation

Anwendungsempfehlungen













Application recommendations

Tournage

Drehen

Turning

700 Series

Géométries de coupe Spannformgeometrien Cutting geometries		Acier de décolletage Automatenstahl Free-cutting steel	Acier Stahl Steel	Acier inoxydable Rostfreistahl Stainless steel	Aluminium	Titane Titan Titanium	Laiton, bronze Messing, Bronze Brass, bronze	Cuivre Kupfer Copper	★	1 ^{er} choix 1. Wahl 1 st choice
									☆	Recommandé Empfohlen Recommended
									☑	Pour pièces fragiles de très petits diamètres Für empfindliche und sehr kleine Werkstücke For fragile and very small work pieces
	0°	★	☑	☑	☑	☑	★	☑		Permet un réaffûtage aisé Erlaubt einfaches Nachschleifen Allows easy regrinding
	X	★	★	★	★	★		★		Très bonne maîtrise du copeau Sehr gute Spankontrolle Very efficient chip control
	X5-EP	★	★	☆						Très bonne maîtrise du copeau (arête de coupe honnée) Sehr gute Spankontrolle (gehonte Schneidkante) Very efficient chip control (honed edge) f min: 0.02 mm/U
	X10-EP	☆	☆	★	☆	☆				Très bonne maîtrise du copeau (arête de coupe honnée) Sehr gute Spankontrolle (gehonte Schneidkante) Very efficient chip control (honed edge) f min: 0.02 mm/U
	VX800	★	★	☆	☆	☆		☆		Très bonne maîtrise du copeau Sehr gute Spankontrolle Very efficient chip control
	VX8°	★	★	☆	☆	☆		☆		Très bonne maîtrise du copeau Sehr gute Spankontrolle Very efficient chip control
	VUX	☆	☆	★	☆	★		☆		Roule-copeau bidirectionnel Bidirektionaler Spanroller Bi-directional chip-breaker
	VX15°	☆		☆	★	★		★		Très bonne maîtrise du copeau Sehr gute Spankontrolle Very efficient chip control
	VS	☆		☆	☑	☑		☑		Brise-copeau pour usinage léger en finition Spanbrecher für leichte Schlichtbearbeitung Chip-breaker for light finishing operation
	ZX10	★	★	★	☆ <5% Si	☆	☆			Très bonne maîtrise du copeau Sehr gute Spankontrolle Very efficient chip control f min: 0.02 mm/U
	ZX17			☆	★ <5% Si	★		★		Très bonne maîtrise du copeau Sehr gute Spankontrolle Very efficient chip control f min: 0.02 mm/U
	ZX25			☆	★ <5% Si	★		★		Très bonne maîtrise du copeau Sehr gute Spankontrolle Very efficient chip control f min: 0.02 mm/U
	ZXT	★	★	★	☆ <5% Si	☆	☆			Très bonne maîtrise du copeau Sehr gute Spankontrolle Very efficient chip control f min: 0.02 mm/U

<h3>TiAlN</h3> <p>μK20 + revêtement PVD μK20 + PVD Beschichtung μK20 + PVD coating</p>	<h3>TiAlX</h3> <p>μK20 + revêtement PVD μK20 + PVD Beschichtung μK20 + PVD coating</p>	<h3>TiN</h3> <p>μK20 + revêtement PVD μK20 + PVD Beschichtung μK20 + PVD coating</p>
<ul style="list-style-type: none"> excellente nuance universelle 1^{er} choix pour l'usinage des aciers, aciers inoxydables et alliages de titane très bonne résistance à la température 	<ul style="list-style-type: none"> nuance très résistante à l'usure et à la température, recommandée pour l'usinage des matières suivantes: Inox 304, 316L, 317L, 904, Phynox aciers alliés contenant: Chrome Nickel, Vanadium, Molybdène, ... 	<ul style="list-style-type: none"> nuance pour l'usinage des matières peu résistantes qui créent des arêtes rapportées très faible coefficient de frottement à éviter pour l'usinage du titane
<ul style="list-style-type: none"> beste Universalsorte für die Bearbeitung von Stahl, rostfreier Stahl und Titanlegierungen bestens geeignet sehr gute Warmfestigkeit 	<ul style="list-style-type: none"> sehr verschleissfeste und temperaturbeständige Sorte. Für folgende Materialien empfohlen: Inox 304, 316L, 317L, 904, Phynox legierter Stahl enthaltend: Chrom-Nickel, Vanadium, Molybdän, ... 	<ul style="list-style-type: none"> Sorte für die Bearbeitung von weichen Werkstoffen mit Tendenz zur Bildung von Aufbauschnitten sehr geringer Reibwert für die Bearbeitung von Titan nicht geeignet
<ul style="list-style-type: none"> best universal grade first choice for steel, stainless steel and titanium alloys machining very good heat resistance 	<ul style="list-style-type: none"> very wear and high temperature resistant grade. Recommended for following material: Inox 304, 316L, 317L, 904, Phynox alloy steel containing: Chrome-nickel, Vanadium, Molybdenum, ... 	<ul style="list-style-type: none"> grade for the machining of low resistance materials which creates build-up edge very low friction ratio not suitable for titanium machining

<h3>LOX</h3> <p>μK20 + revêtement PVD μK20 + PVD Beschichtung μK20 + PVD coating</p>	<h3>N (μK20)</h3> <p>non revêtu unbeschichtet uncoated</p>
<ul style="list-style-type: none"> nuance résistante à l'usure et à la température, destinée à l'usinage des matières suivantes: Inox, Titanes, alliages à base de Nickel, Chrome Cobalt, les matières avec une dureté supérieure à > 50HRC bonne alternative pour l'usinage des aciers de construction types ETG88, ETG100, 36SMnPb14 	<ul style="list-style-type: none"> supporte les coupes interrompues et autres conditions d'usinage défavorables
<ul style="list-style-type: none"> verschleissfeste und temperaturbeständige Sorte. Für folgende Materialien empfohlen: Inox, Titan, Nickellegierungen, Chrom-Kobalt, Materialien härter als > 50HRC gute Alternative für die Bearbeitung von Baustähle Typ ETG88, ETG100, 36SMnPb14 	<ul style="list-style-type: none"> für unterbrochene Schnitte und andere ungünstige Bearbeitungsbedingungen geeignet
<ul style="list-style-type: none"> wear and high temperature resistant grade. Recommended for following materials: inox, titanium, nickel alloys, materials harder than > 50HRC good alternative for machining of structural steels type ETG88, ETG100, 36SMnPb14 	<ul style="list-style-type: none"> suitable for interrupted cut and other unfavourable machining conditions

Nuances micro-grain à dureté élevée

Verschleissfeste Feinkornsorten

Wear resistant micro-grain grades

μK 10

HTA

μK10 + revêtement PVD
μK10 + PVD Beschichtung
μK10 + PVD coating

- nuance très résistante à l'usure
- pour l'usinage en finition dans des conditions favorables des aciers, aciers inoxydables et alliages de titane

- sehr verschleissfeste Sorte
- für die Feinbearbeitung von Stahl, rostfreiem Stahl und Titanlegierungen bei guten Bearbeitungsbedingungen

- very wear resistant grade
- for light machining of steel, stainless steel and titanium alloys under favourable machining conditions

HTAX

μK10 + revêtement PVD
μK10 + PVD Beschichtung
μK10 + PVD coating

- nuance très résistante à l'usure et à la température, pour l'usinage en finition avec faibles avances de petites pièces, recommandée pour l'usinage des matières suivantes: Inox 304, 316L, 317L, 904, Phynox
- aciers alliés contenant: Chrome Nickel, Vanadium, Molybdène, ...

- sehr verschleissfeste und temperaturbeständige Sorte. Für Feinbearbeitung von kleinen Teilen mit geringer Vorschub. Für folgende Materialien empfohlen: Inox 304, 316L, 317L, 904, Phynox
- legierter Stahl enthaltend: Chrom-Nickel, Vanadium, Molybdän, ...

- very wear and high temperature resistant grade. For light machining of small parts with low cutting feed. Recommended for following material: Inox 304, 316L, 317L, 904, Phynox
- alloy steel containing: Chrome-nickel, Vanadium, Molybdenum, ...

HTiN

μK10 + revêtement PVD
μK10 + PVD Beschichtung
μK10 + PVD coating

- nuance pour l'usinage en finition des matières peu résistantes qui créent des arêtes rapportées
- très faible coefficient de frottement
- à éviter pour l'usinage du titane

- Sorte für die Feinbearbeitung von weichen Werkstoffen mit Tendenz zur Bildung von Aufbauschneiden
- sehr geringer Reibwert
- für die Bearbeitung von Titan nicht geeignet

- grade for light machining of low resistance materials which creates build-up edge
- very low friction ratio
- not suitable for titanium machining

HAS

μK10 + revêtement PVD
μK10 + PVD Beschichtung
μK10 + PVD coating

- nuance pour métaux non ferreux
- très faible coefficient de frottement
- 1^{er} choix pour l'usinage des aluminiums jusqu'à 5% Si, des cuivres et titanes faiblement alliés

- Sorte für Nichteisenmetalle
- sehr geringer Reibwert
- für die Bearbeitung von Aluminium bis 5% Si, Kupfer und niedriglegiertem Titan bestens geeignet

- grade for non-ferrous materials
- very low friction ratio
- first choice for aluminium up to 5% Si, copper and low alloyed titanium

HN (μK10)

non revêtu
unbeschichtet
uncoated

- nuance micro-grain très résistante à l'usure
- recommandé pour l'usinage du titane faiblement allié
- déconseillé en cas de coupe interrompue et autres conditions d'usinage défavorables

- verschleissfeste Feinkornsorte
- für die Bearbeitung von niedrig legiertem Titan empfehlenswert
- für unterbrochene Schnitte und andere ungünstige Bearbeitungsbedingungen nicht geeignet

- wear resistant micro-grain grade
- suitable for the machining of low alloyed titanium
- not suitable for interrupted cut and other unfavourable machining conditions

Paramètres de coupe indicatifs

Empfohlene Schnittwerte

Standard machining data

Matière Werkstoff Material	Tournage Drehen Turning			Tronçonnage Abstechen Parting off		
	VC	Prof. de passe Schnitttiefe Depth of cut	Avance Vorschub Feed	VC	Largeur de coupe Abstechbreite Cutting width	Avance Vorschub Feed
	(m/min)	(mm)	(mm/U)	(m/min)	(mm)	(mm/U)
Acier de décolletage Automatenstahl Free-cutting steel P	120 - 200	0.05 - 1.0 1.0 - 4.0	0.01 - 0.15 0.05 - 0.25	80 - 150	0.50 - 1.50 1.50 - 3.50	0.01 - 0.08 0.03 - 0.15
Acier Stahl < 600 N/mm ² P	80 - 160	0.05 - 1.0 1.0 - 4.0	0.01 - 0.15 0.05 - 0.25	70 - 120	0.50 - 1.50 1.50 - 3.50	0.01 - 0.06 0.03 - 0.12
Acier Stahl < 800 N/mm ² P	60 - 120	0.05 - 1.0 1.0 - 4.0	0.01 - 0.10 0.05 - 0.20	60 - 100	0.50 - 1.50 1.50 - 3.50	0.01 - 0.05 0.03 - 0.10
Acier Stahl > 800 N/mm ² P	50 - 100	0.05 - 1.0 1.0 - 3.0	0.01 - 0.08 0.05 - 0.15	40 - 80	0.50 - 1.50 1.50 - 3.50	0.01 - 0.04 0.03 - 0.08
Acier inoxydable Rostfreistahl Stainless steel M	60 - 120	0.05 - 1.0 1.0 - 3.0	0.01 - 0.08 0.05 - 0.15	60 - 100	0.50 - 1.50 1.50 - 3.50	0.01 - 0.04 0.03 - 0.08
Aluminium Si <12% N	200 - 1000	0.05 - 1.0 1.0 - 4.0	0.01 - 0.20 0.05 - 0.40	180 - 400	0.50 - 1.50 1.50 - 3.50	0.01 - 0.10 0.03 - 0.20
Aluminium Si >12% N	180 - 800	0.05 - 1.0 1.0 - 4.0	0.01 - 0.20 0.05 - 0.40	150 - 300	0.50 - 1.50 1.50 - 3.50	0.01 - 0.10 0.03 - 0.20
Cuivre, laiton, bronze Kupfer, Messing, Bronze Copper, brass, bronze N	100 - 500	0.05 - 1.0 1.0 - 4.0	0.01 - 0.20 0.05 - 0.35	100 - 300	0.50 - 1.50 1.50 - 3.50	0.01 - 0.10 0.03 - 0.20
Titane Titan Titanium S	30 - 70	0.05 - 1.0 1.0 - 4.0	0.01 - 0.08 0.05 - 0.15	30 - 50	0.50 - 1.50 1.50 - 3.50	0.01 - 0.03 0.03 - 0.06

Indications pour premier réglage
Hinweise für die erste Einrichtung
Indications for first setting

Ébauche Schruppen Roughing	Finition Schlichten Finishing
<ul style="list-style-type: none"> • vitesse de coupe moyenne • avance élevée 	<ul style="list-style-type: none"> • vitesse de coupe élevée • avance faible
<ul style="list-style-type: none"> • durchschnittliche Schnittgeschwindigkeit • hohe Schnittgeschwindigkeit 	<ul style="list-style-type: none"> • hohe Schnittgeschwindigkeit • niedriger Vorschub
<ul style="list-style-type: none"> • average cutting speed • high cutting speed 	<ul style="list-style-type: none"> • high cutting speed • low cutting feed

Remarques importantes
Wichtige Bemerkungen
Important remarks

- en raison des limites de la machine, il n'est souvent pas possible d'atteindre les vitesses de coupe préconisées
- les outils Applitec sont spécialement développés pour permettre de hautes performances, même dans des conditions de coupe défavorables
- des applications non préconisées dans le tableau ci-contre peuvent également s'avérer efficaces

- wegen begrenzter Maschinenleistung ist es oft nicht möglich, die vorgeschlagenen Schnittgeschwindigkeiten zu erreichen
- Applitec Werkzeuge sind besonders dazu entwickelt, um sogar bei ungünstigen Schnittdaten leistungsfähig zu sein
- die in der nebenstehender Tabelle nicht erwähnten Anwendungsfälle können sich auch effizient erweisen

- in many cases, it is impossible to reach the recommended cutting speed, due to the machine limits
- Applitec tools are especially designed to be efficient even in bad cutting conditions
- applications not mentioned in the opposite table can also be efficient

L		R	
Type	Page	Type	Page
710	1.14	720	1.14
710-NOVIBRA	1.15	721	1.16
711	1.16	721-EP	1.23
711-EP	1.23	722	1.17
712	1.17	723-30	1.18
713-30	1.18	723-45	1.19
713-45	1.19	723-60	1.20
713-60	1.20	724	1.21
714	1.21	726	1.22
716	1.22		

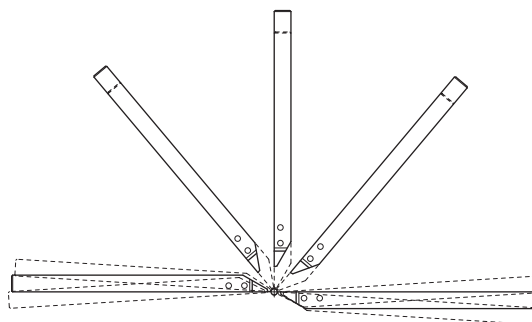

Porte-outils et plaquettes pour machines à cames
 Halter und WSP für kurvengesteuerte Maschinen
 Tool holders and inserts for cam driven machines

	711 / 721 Tronçonnage Abstechen Parting off		710 / 720 Porte-outils Halter Holders	> 1.14
	713 / 723 Tournage arrière Rückwärts drehen Back turning		712 / 722 Tournage avant Vorwärts drehen Front turning	> 1.16
	716 / 726 Filetage Gewinde drehen Threading		714 / 724 Fonçage-tournage Einstechen und drehen Grooving and turning	> 1.17
			Plaquette ébauche WSP-Rohling Blank insert	> 1.21
				> 1.22
				> 1.23

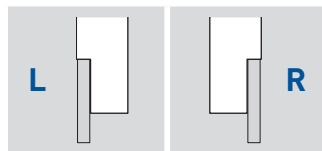
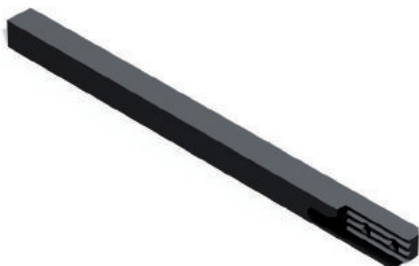
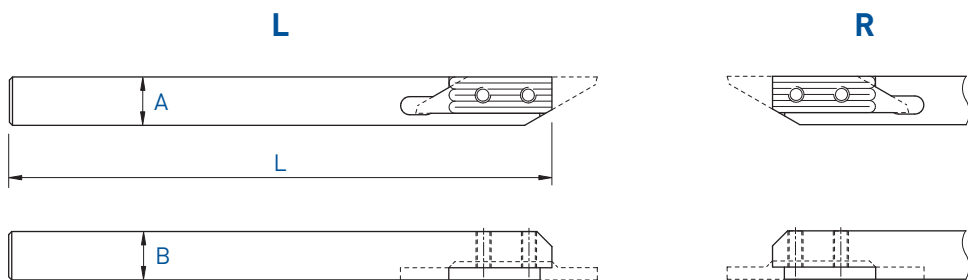

A x B	L	Serrage Spannsystem Clamping	Art. N°	Art. N°
6 x 6	115	A	710-6	-
7 x 7	115	A	710-7	720-7
8 x 8	115	A	710-8	720-8
8 x 8	140	A	710-8-140	-
10 x 10	115	A	710-10	720-10
12 x 12	130	A	710-12	720-12



Chaque support est livré avec vis et clé.
 Jeder Halter wird mit Spannschraube(n) und Schlüssel geliefert.
 Screw(s) and key are included with each tool holder.

Porte-outils en métal lourd anti-vibratoire
 Schwingungsdämpfende Schwermetallhalter
 Low vibration heavy metal holders

710-NOVIBRA

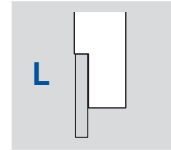
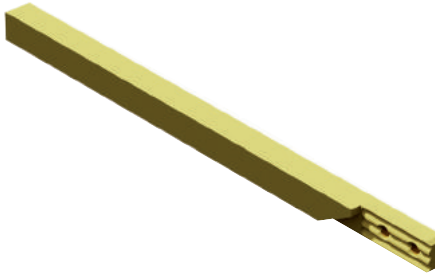
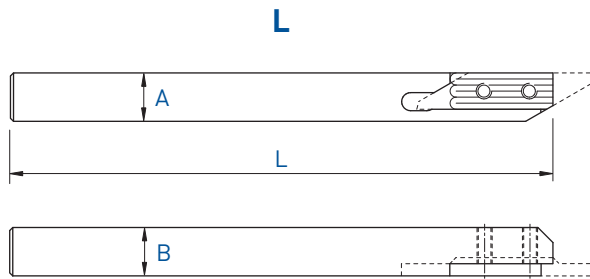

A x B	L	Serrage Spannsystem Clamping	Art. N°
6 x 6	115	A	710-6-NOVIBRA
7 x 7	115	A	710-7-NOVIBRA
8 x 8	115	A	710-8-NOVIBRA



Chaque support est livré avec vis et clé.
 Jeder Halter wird mit Spannschraube(n) und Schlüssel geliefert.
 Screw(s) and key are included with each tool holder.

L

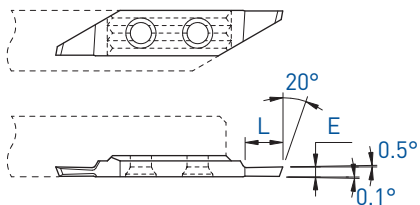

R

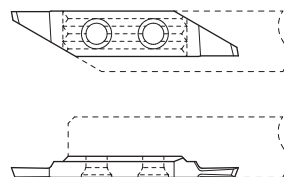

L



R



E	L	Art. N°	L			R			Art. N°	R					
			TiAlN	TiN	N (µk20)	HTA	HTiN	HN (µk10)		TiAlN	TiN	N (µk20)	HTA	HTiN	HN (µk10)
0.5	2	711-0.5	■	■	■	■	□	■	-						
0.8	3	711-0.8	■	■	■	■	■	■	721-0.8	■	■	■			
0.9	3	711-0.9	■	■	■	■	□	■	-						
1.0	4	711-1.0	■	■	■	■	■	■	721-1.0	■	■	■	■	□	■
1.1	4	711-1.1	■	■	■	■	■	■	-						
1.2	5	711-1.2	■	■	■	■	■	■	721-1.2	■	■	■	■	□	■
1.3	5	711-1.3	■	■	■	■	□	■	-						
1.4	5	711-1.4	■	■	■				-						
1.5	6.5	711-1.5	■	■	■	■	■	■	721-1.5	■	■	■	■	□	■
1.8	6.5	711-1.8	■	■	■	■	□	■	721-1.8	■	■	■			
2.0	6.5	711-2.0	■	■	■				721-2.0	■	■	■			

Tournage avant
Vorwärts drehen
Front turning

712 / 722

L

R

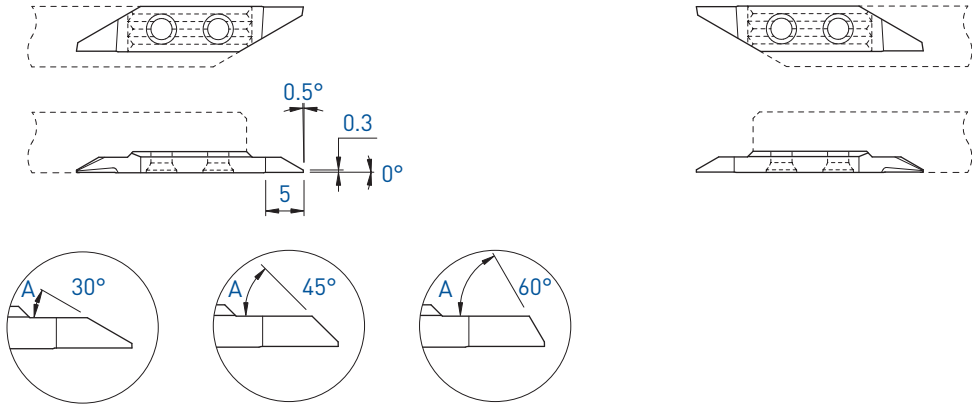

	L						R							
A	Art. N°	TiAlN	TiN	N (µk20)	HTA	HTIN	HN (µk10)	Art. N°	TiAlN	TiN	N (µk20)	HTA	HTIN	HN (µk10)
30°	712-30	■	■	■	■	□	■	722-30	■	■	■	■	□	■
45°	712-45	■	■	■	■	■	■	722-45	■	■	■	■	□	■
60°	712-60	■	■	■	■	□	■	722-60	■	■	■	■	□	■

TOP-LINE

Tournage arrière
 Rückwärts drehen
 Back turning

713-30° / 723-30°

L

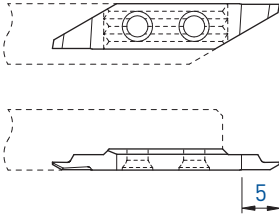

R

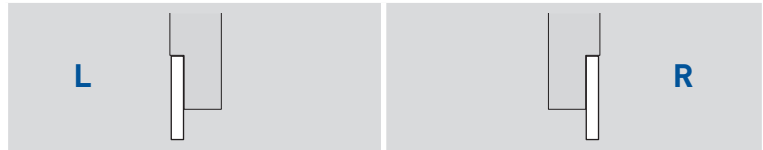
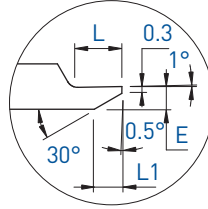
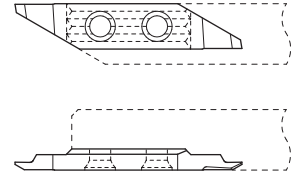

E	L	L1	Art. N°	L			R									
				TiAlN	TiN	N (µk20)	HTA	HTiN	HN (µk10)	Art. N°	TiAlN	TiN	N (µk20)	HTA	HTiN	HN (µk10)
0.8	1.6	0.85	713-30-0.8	■	■	■				723-30-0.8	■	■	■	■	□	■
0.9	1.6	1.05	713-30-0.9	■	■	■				-						
1.0	2.0	1.2	713-30-1.0	■	■	■	■	□	■	723-30-1.0	■	■	■	■	□	■
1.1	2.0	1.4	713-30-1.1	■	■	■				-						
1.2	2.5	1.55	713-30-1.2	■	■	■				723-30-1.2	■	■	■			
1.3	2.5	1.7	713-30-1.3	■	■	■				-						
1.4	3.0	1.9	713-30-1.4	■	■	■				-						
1.5	3.0	2.1	713-30-1.5	■	■	■	■	■	■	723-30-1.5	■	■	■	■		
1.8	4.0	2.6	713-30-1.8	■	■	■				723-30-1.8	■	■	■			
2.0	4.0	2.9	713-30-2.0	■	■	■	■	■	■	723-30-2.0	■	■	■			

Tournage arrière
 Rückwärts drehen
 Back turning

713-45° / 723-45°

L

R

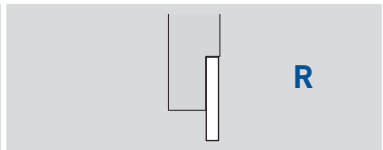
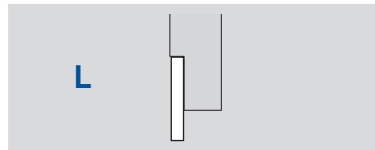
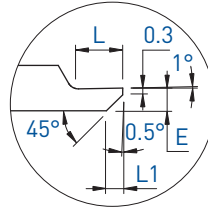
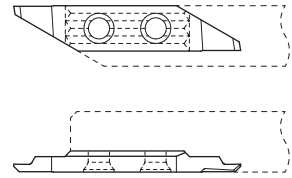
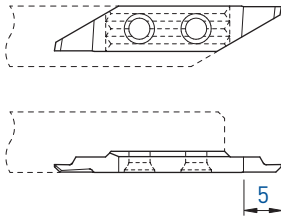

E	L	L1	Art. N°	TiAlN	TiN	N (µk20)	HTA	HTiN	HN (µk10)	Art. N°	TiAlN	TiN	N (µk20)	HTA	HTiN	HN (µk10)
0.8	1.6	0.5	713-45-0.8	■	■	■	■	□	■	723-45-0.8	■	■	■			
0.9	1.6	0.6	713-45-0.9	■	■	■				-						
1.0	2.0	0.7	713-45-1.0	■	■	■	■	□	■	723-45-1.0	■	□	■			
1.1	2.0	0.8	713-45-1.1	■	■	■				-						
1.2	2.5	0.9	713-45-1.2	■	■	■				723-45-1.2	■	■	■			
1.3	2.5	1.0	713-45-1.3	■	■	■				-						
1.4	3.0	1.1	713-45-1.4	■	■	■				-						
1.5	3.0	1.2	713-45-1.5	■	■	■	■	■	■	723-45-1.5	■	□	■			
1.8	4.0	1.5	713-45-1.8	■	■	■				723-45-1.8	■	□	■			
2.0	4.0	1.7	713-45-2.0	■	■	■				723-45-2.0	■	■	■			

■ = disponible / verfügbar / available
 □ = selon disponibilité du stock / jenach Lagerverfügbarkeit / depending on stock availability

TOP-LINE

Tournage arrière
Rückwärts drehen
Back turning

713-60° / 723-60°

L

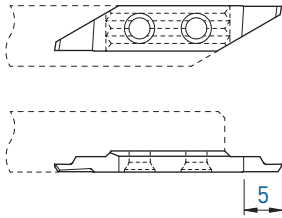

R

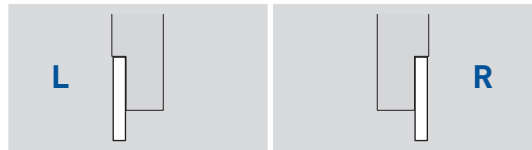
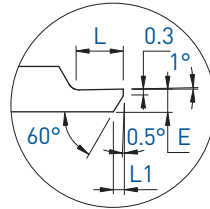
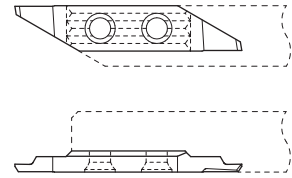

E	L	L1	Art. N°	TiAlN	TiN	N (µk20)	Art. N°	TiAlN	TiN	N (µk20)
0.8	1.6	0.3	713-60-0.8	■	■	■	723-60-0.8	■	■	■
0.9	1.6	0.35	713-60-0.9	■	■	■	-			
1.0	2.0	0.4	713-60-1.0	■	■	■	723-60-1.0	■	□	■
1.1	2.0	0.45	713-60-1.1	■	■	■	-			
1.2	2.5	0.5	713-60-1.2	■	■	■	723-60-1.2	■	□	■
1.3	2.5	0.6	713-60-1.3	■	■	■	-			
1.4	3.0	0.65	713-60-1.4	■	■	■	-			
1.5	3.0	0.7	713-60-1.5	■	■	■	723-60-1.5	■	■	■
1.8	4.0	0.9	713-60-1.8	■	■	■	723-60-1.8	■	□	■
2.0	4.0	1.0	713-60-2.0	■	■	■	723-60-2.0	■	■	■

Fonçage-tournage

Einstecken und drehen

Grooving and turning

714 / 724

L

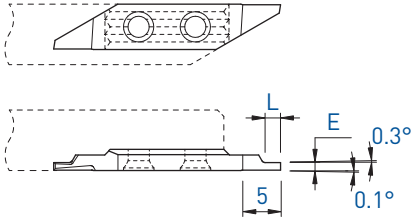

R

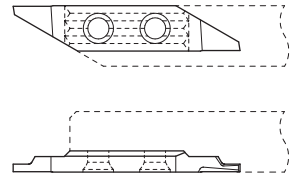

L

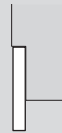

R



E	L	Art. N°	TiAlN	TiN	N (µk20)	HTA	HTiN	HN (µk10)	Art. N°	TiAlN	TiN	N (µk20)	HTA	HTiN	HN (µk10)
0.5	1.0	714-0.5	■	■	■				724-0.5	■	■	■	■	□	■
0.6	1.0	714-0.6	■	■	■				724-0.6	■	■	■			
0.7	1.5	714-0.7	■	■	■				724-0.7	■	■	■			
0.8	1.5	714-0.8	■	■	■	■	□	■	724-0.8	■	■	■			
0.9	2.0	714-0.9	■	■	■				724-0.9	■	□	■			
1.0	2.0	714-1.0	■	■	■	■	■	■	724-1.0	■	■	■			
1.1	2.0	714-1.1	■	■	■				724-1.1	■	□	■			
1.2	2.5	714-1.2	■	■	■				724-1.2	■	□	■			
1.3	2.5	714-1.3	■	■	■				724-1.3	■	■	■			
1.4	3.0	714-1.4	■	■	■				724-1.4	■	□	■			
1.5	3.0	714-1.5	■	■	■	■	■	■	724-1.5	■	■	■			

■ = disponible / verfügbar / available

□ = selon disponibilité du stock / jenach Lagerverfügbarkeit / depending on stock availability

L

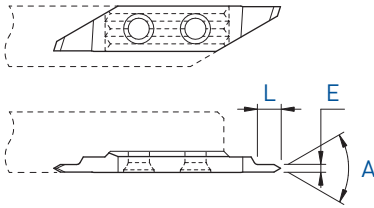

R

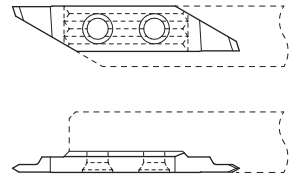

L

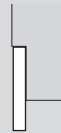

R



A	E	L	Art. N°	TiAlN	TiN	N (µm20)	Art. N°	TiAlN	TiN	N (µm20)
60°	1.0	3	716-60-1.0	■	■	■	726-60-1.0	■	■	■
60°	1.5	4	716-60-1.5	■	■	■	726-60-1.5	■	■	■
55°	1.0	3	716-55-1.0	■	■	■	726-55-1.0	■	□	■
55°	1.5	4	716-55-1.5	■	■	■	726-55-1.5	■	□	■

Plaquettes ébauches

WSP-Rohlinge

Blank inserts

711-EP / 721-EP

L

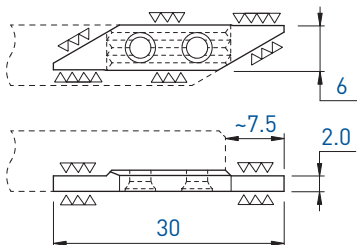

R

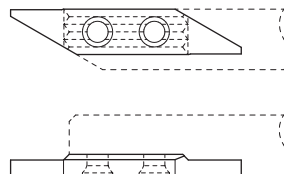

L		R			
Art. N°	TiAlN TiN N (µk20)	HTA HTiN HN (µk10)	Art. N°	TiAlN TiN N (µk20)	HTA HTiN HN (µk10)
711-EP	■ ■ ■	■ □ ■	721-EP	■ □ ■	□ □ ■

L			R		
Type		Page	Type		Page
730	730	1.26	740	740	1.26
	730-JET	1.27		740/730-D	1.31
	730-NOVIBRA	1.30		740-C	1.28
	730RC	1.29		740-JET	1.27
731	731	1.32		740-NOVIBRA	1.30
	731-E	1.67	741	741	1.32
	731N	1.38/1.45		741-E	1.67
	731R	1.39		741L	1.39
	731RU	1.44		741LX12	1.42
	731RX12	1.42		741LX25	1.43
	731RX25	1.43		741LX4	1.40
	731RX4	1.40		741LXF	1.41
	731RXF	1.41		741N	1.38/1.45
	731U	1.37		741U	1.37
	731X12	1.35		741X12	1.35
	731X25	1.36		741X25	1.36
	731X4	1.33		741X4	1.33
	731XF	1.34		741XF	1.34
732	732	1.46	742	742	1.46
	732PX	1.47		742PX	1.47
	732X	1.48		742X	1.48
733	733	1.49	743	743	1.49
	733P	1.55		743P	1.55
	733VX-15°	1.53		743VX-15°	1.53
	733VX-8°	1.51		743VX-8°	1.51
	733VX-805	1.52		743VX-805	1.52
	733X	1.50		743X	1.50
	733ZX	1.54		743ZX10	1.54
734	734	1.56	744	744	1.56
	734VS	1.57		744VS	1.57
	734X	1.58		744X	1.58
	734ZX	1.59		744ZX	1.59
735	735	1.61		744ZXT	1.60
	735X-90	1.62	745	745	1.61
736	736	1.63		745X-90	1.62
	736-A60°	1.64	746	746	1.63
	736-M	1.65		746-A60°	1.64
737	737	1.66		746-M	1.65
			747	747	1.66

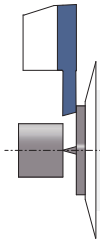
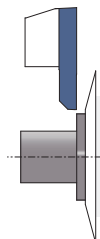
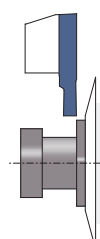
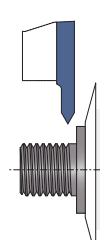
		730 / 740 Porte-outils Halter Holders	> 1.26
	731 / 741 Tronçonnage Abstechen Parting off		> 1.32
		741L / 731R Tronçonnage - coupe déportée Abstechen - versetztes Schneiden Parting off - cut off line	> 1.39
	732 / 742 Tournage avant Vorwärts drehen Front turning		> 1.46
		733 / 743 Tournage arrière Rückwärts drehen Back turning	> 1.49
	734 / 744 Fonçage-tournage Einstechen und drehen Grooving and turning		> 1.56
		735 / 745 Gorges Einstechen Grooving	> 1.61
	736 / 746 Filetage Gewinde drehen Threading		> 1.63
		737 / 747 Plaquettes à rayon Radius Wendeplatten Radius inserts	> 1.66
	Plaquettes ébauches WSP-Rohlinge Blank inserts		> 1.67

L

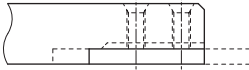
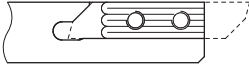

R

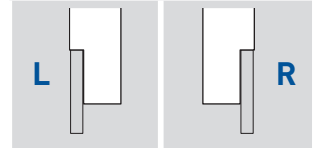
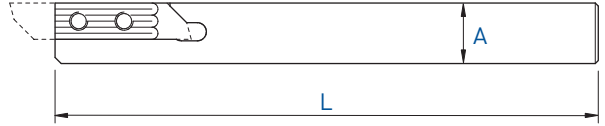

Serrage standard A
Standard Spannsystem A
Standard clamping system A

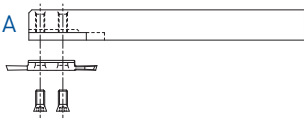

Serrage B
Spannsystem B
Clamping system B

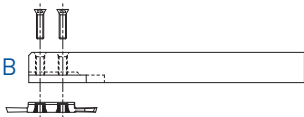

A x B	L	Serrage Spannsystem Clamping	Art. N°	Art. N°
7 x 7	115	A	730-7	740-7
8 x 8	115	A + B	730-8	740-8
8 x 8	140	A + B	730-8-140	-
10 x 10	115	A + B	730-10	740-10
10 x 10	50	A + B	730-10-50	740-10-50
12 x 12	130	A + B	730-12	740-12
12 x 12	90	A + B	730-12-90	740-12-90
12.7 x 12.7	130	A + B	730-12.7	740-12.7
16 x 16	130	A + B	730-16	740-16
16 x 16	75	A + B	730-16-75	740-16-75
20 x 20	120	A + B	730-20	740-20

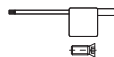

Chaque support est livré avec vis et clé.
Jeder Halter wird mit Spannschraube(n) und Schlüssel geliefert.
Screw(s) and key are included with each tool holder.



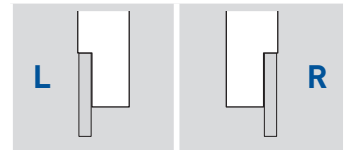
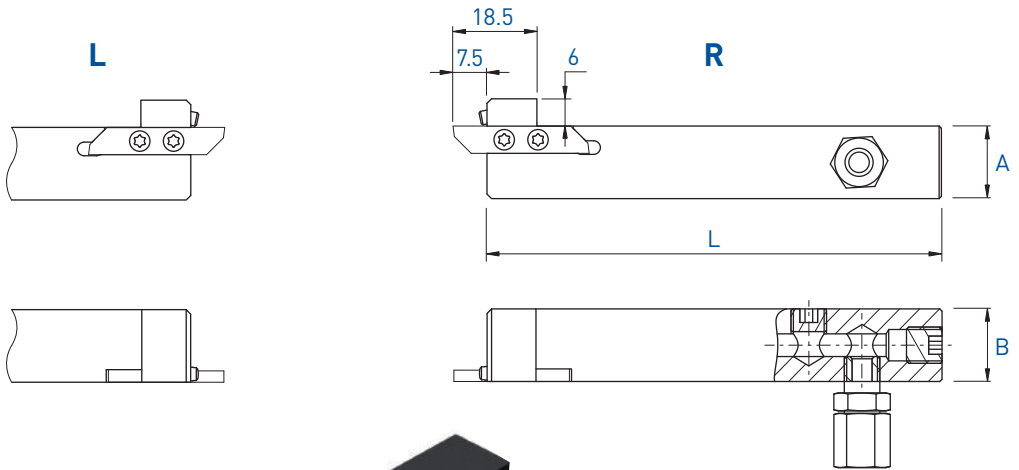

Porte-outils avec arrosage intégré
 Halter mit integrierter Kühlmittelzufuhr
 Holders with integrated coolant supply

730-JET / 740-JET

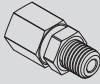

A x B	L	Serrage Spannsystem Clamping	Art. N°	Art. N°
8 x 10	100	A + B	-	740-0810-JET
10 x 12	100	A + B	730-1012-JET	740-1012-JET
10 x 12	80	A + B	-	740-1012-80-JET new
12 x 12	100	A + B	730-12-JET	740-12-JET
12.7 x 12.7	100	A + B	730-12.7-JET	740-12.7-JET
16 x 16	100	A + B	730-16-JET	740-16-JET
20 x 20	100	A + B	730-20-JET	740-20-JET



Pièces de rechange Ersatzteile Spare parts			Buse Düse Nozzle 	Option 
	Art. N°	Art. N°	Art. N°	Art. N°
740-0810-JET	J-M5-D5	JB-M5	-	JC-M5-D5
730-JET / 740-JET	J-M8X1-D6	JB-M8X1	JJ-M3X6-D1.5	-

Chaque support est livré avec vis et clé.
 Jeder Halter wird mit Spannschraube(n) und Schlüssel geliefert.
 Screw(s) and key are included with each tool holder.



R

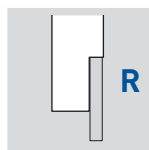
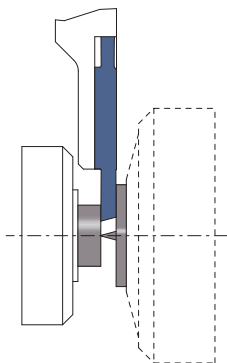
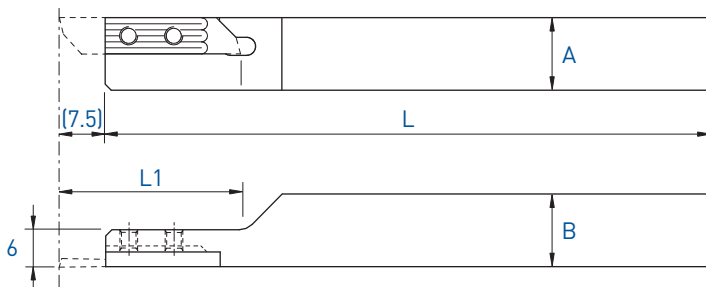

A x B	L	L1	Serrage Spannsystem Clamping	Art. N°
8 x 8	115	24	A	740-C-8
10 x 10	115	24	A	740-C-10
12 x 12	130	30	A	740-C-12
16 x 16	130	40	A	740-C-16

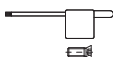

Chaque support est livré avec vis et clé.
Jeder Halter wird mit Spannschraube(n) und Schlüssel geliefert.
Screw(s) and key are included with each tool holder.

Porte-outils

Halter

Holders

Coupe à droite déportée

Versetztes Rechtsschneiden

Right cut off line

730RC

Utiliser des plaquettes type 731R
 WSP Typ 731R verwenden
 Use inserts type 731R

Voir pages 1.39 - 1.45
 Siehe Seiten 1.39 - 1.45
 See pages 1.39 - 1.45

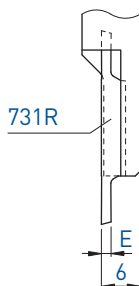
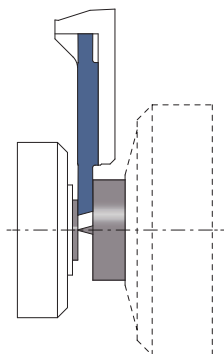
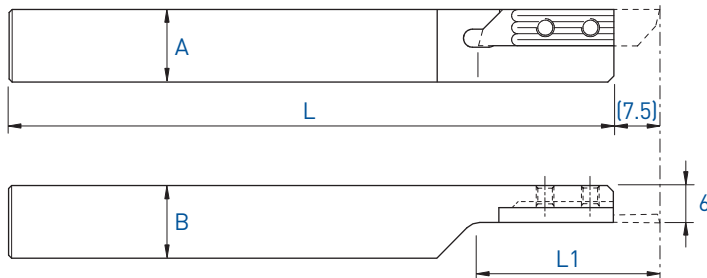

L (R)

Coupe à droite déportée
 Versetztes Rechtsschneiden
 Right cut off line



A x B	L	L1	Art. N°
8 x 8	115	24	730RC-8
10 x 10	115	24	730RC-10
12 x 12	130	30	730RC-12
16 x 16	130	40	730RC-16

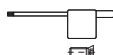

Chaque support est livré avec vis et clé.
 Jeder Halter wird mit Spannschraube(n) und Schlüssel geliefert.
 Screw(s) and key are included with each tool holder.

TOP-LINE

Porte-outils en métal lourd anti-vibratoire
 Schwingungsdämpfende Schwermetallhalter
 Low vibration heavy metal holders

730-NOVIBRA
 740-NOVIBRA

L

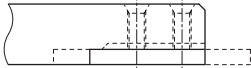
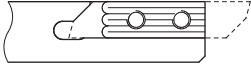

R

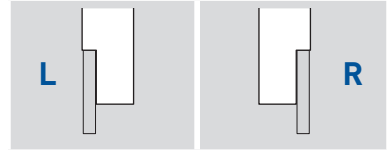
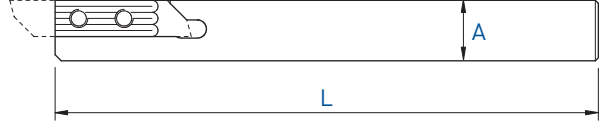

A x B	L	Serrage Spannsystem Clamping	Art. N°	Art. N°
7 x 7	115	A	730-7-NOVIBRA	740-7-NOVIBRA
8 x 8	115	A + B	730-8-NOVIBRA	740-8-NOVIBRA
8 x 8	80	A + B	-	740-8-80-NOVIBRA
10 x 10	115	A + B	-	740-10-NOVIBRA
12 x 12	130	A + B	-	740-12-NOVIBRA

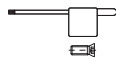

Chaque support est livré avec vis et clé.
 Jeder Halter wird mit Spannschraube(n) und Schlüssel geliefert.
 Screw(s) and key are included with each tool holder.

Porte-outils

Halter

Holder

740 / 730-D

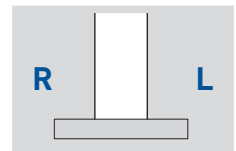
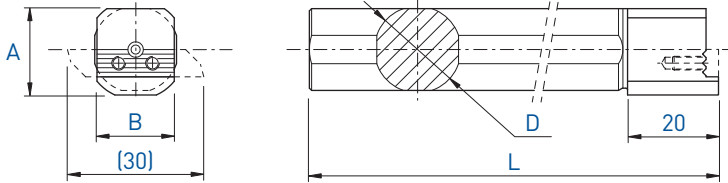

A x B	L	D	Art. N°
19 x 17	160	16	740/730-D16
19 x 17	160	19.05	740/730-D19.05
19 x 17	110	19.05	740/730-D19.05-S
19.5 x 17	160	20	740/730-D20
20 x 17	110	22	740/730-D22
22 x 17	200	25	740/730-D25
22 x 17	200	25.4	740/730-D25.4

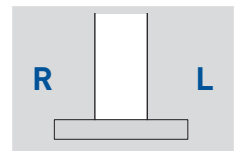
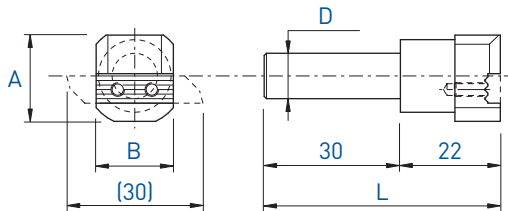

A x B	L	D	Art. N°
19 x 17	52	10	740/730-D10

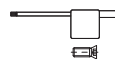

Chaque support est livré avec vis et clé.
 Jeder Halter wird mit Spannschraube(n) und Schlüssel geliefert.
 Screw(s) and key are included with each tool holder.

Tronçonnage
Abstechen
Parting off

731 / 741

L

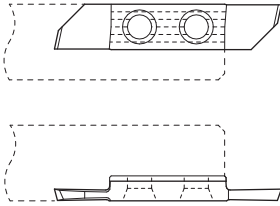

R

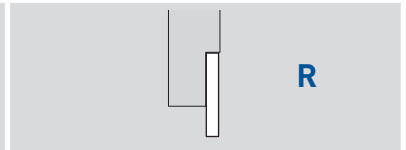
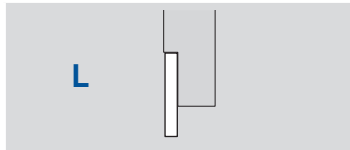
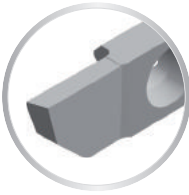
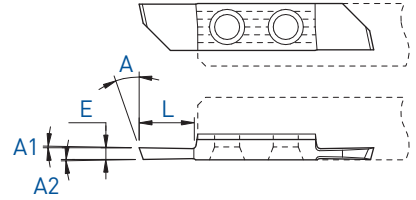

E	A	A1	A2	L	Art. N°	TiAlN	TiN	N (µk20)	HTA	HTiN	HN (µk10)	Art. N°	TiAlN	TiAlX	TiN	N (µk20)	HTA	HTiN	HN (µk10)		
0.6	18°	2.5°	0.5°	3	731-0.6	■	■	■	■	■	■	741-0.6	■	■	■	■	■	■	■	■	
0.8	20°	0.3°	0.3°	5	731-0.8	■	■	■	■	□	■	741-0.8	■	■	■	■	■	■	■	■	
1.0	20°	0.3°	0.3°	5	731-1.0	■	■	■	■	■	■	741-1.0	■	■	■	■	■	■	■	■	
1.2	20°	0.3°	0.3°	5	731-1.2	■	■	■	■	□	■	741-1.2	■	■	■	■	■	■	■	■	
1.5	20°	0.3°	0.3°	7	731-1.5	■	■	■	■	■	■	741-1.5	■	■	■	■	■	■	■	■	
1.8	20°	0.3°	0.3°	7	731-1.8	■	■	■	■	□	■	741-1.8	■	■	■	■	■	■	□	■	
2.0	20°	0.3°	0.3°	7	731-2.0	■	■	■	■	□	■	741-2.0	■	■	■	■	■	■	■	■	
2.5	20°	0.3°	0.3°	7	731-2.5	■	■	■	■	■	■	741-2.5	■	■	■	■	■	■	■	□	■

7XX-XX-B



Sur demande pour serrage type B, voir page 1.03
Wahlweise mit B-Spannsystem, siehe Seite 1.03
On request for B clamping system, see page 1.03

Tronçonnage
Abstechen
Parting off

731X4 / 741X4

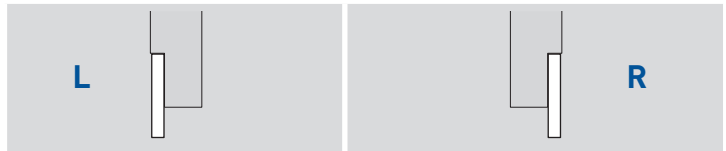
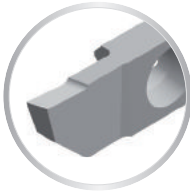
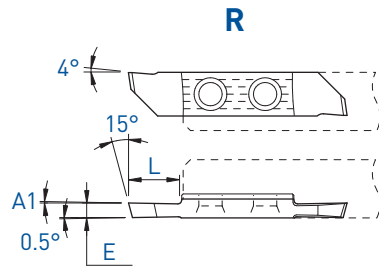
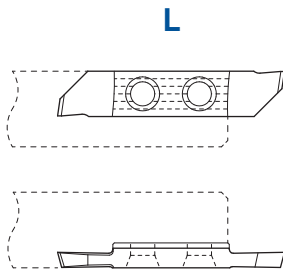

E	A1	L	Art. N°	L			R			Art. N°	R			HTA	HTiN	HN [µk10]
				TiAlN	TiN	N [µk20]	TiAlN	TiAlX	TiN		N [µk20]					
0.6	2.5°	3	731X4-0.6	■	■	■	■	■	741X4-0.6	■	■	■	■	■	■	■
0.8	0.5°	4	-						741X4-0.8							
1.0	0.5°	5	731X4-1.0	■	■	■			741X4-1.0	■	■	■	■	□	■	
1.5	0.5°	7	731X4-1.5	■	■	■	■	□	741X4-1.5	■	■	■	■	□	■	
2.0	0.5°	7	731X4-2.0	■	■	■			741X4-2.0	■	■	■	■			

7XX-XX-B

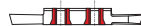

Sur demande pour serrage type B, voir page 1.03
Wahlweise mit B-Spannsystem, siehe Seite 1.03
On request for B clamping system, see page 1.03

■ = disponible / verfügbar / available
□ = selon disponibilité du stock / jenach Lagerverfügbarkeit / depending on stock availability

- Tronçonnage
- Abstechen
- Parting off

731XF / 741XF

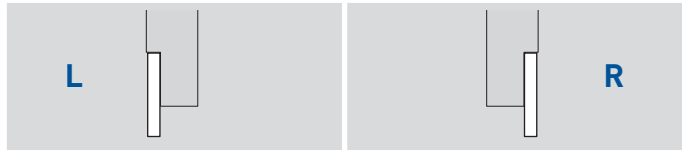
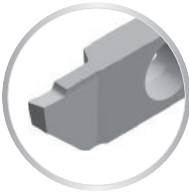
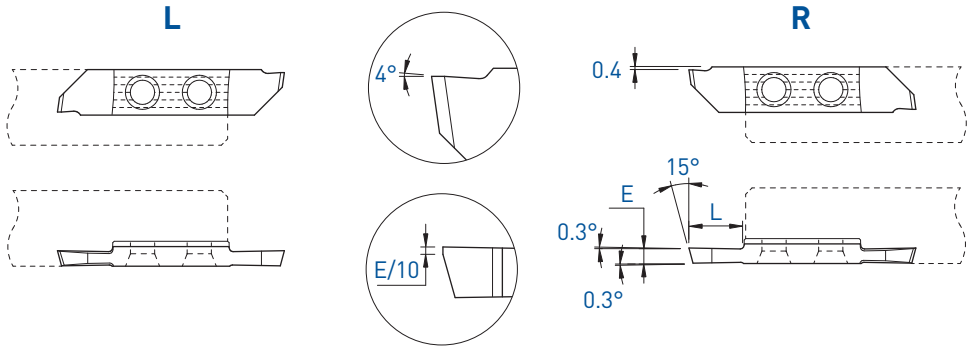

E	L	Art. N°	L			R								
			TiAlN	TiN	N (µk20)	HTA	HTiN	HN (µk10)						
1.2	5	-						741XF-1.2	■	□	■			
1.5	7	731XF-1.5	■	■	■	■	■	■	741XF-1.5	■	■	■	■	■
2.0	7	731XF-2.0	■	■	■				741XF-2.0	■	■	■	■	■
2.5	7	731XF-2.5	■	■	■				741XF-2.5	■	■	■		

7XX-XX-B



Sur demande pour serrage type B, voir page 1.03
 Wahlweise mit B-Spannsystem, siehe Seite 1.03
 On request for B clamping system, see page 1.03

Tronçonnage

Abstechen

Parting off

731X12 / 741X12

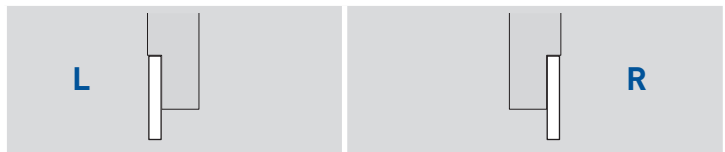
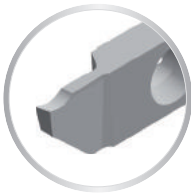
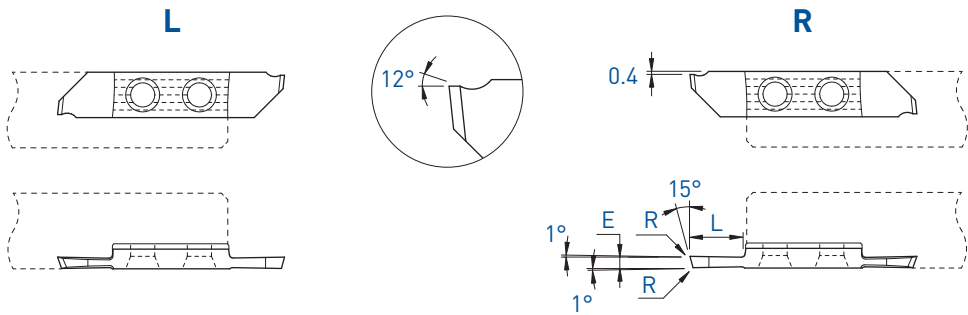

E	L	R	Art. N°	TiAlN	TiN	N (µk20)	HTA	HTiN	HN (µk10)	Art. N°	TiAlN	TiAlX	TiN	N (µk20)	HTA	HTiN	HN (µk10)
0.5	3	0.03	-							741X12-0.5					■		■
1.0	5	0.03	731X12-1.0	■	■	■				741X12-1.0	■	■	■	■	■	□	■
1.5	7	0.03	731X12-1.5	■	■	■				741X12-1.5	■	■	■	■	■	■	■
2.0	7	0.03	731X12-2.0	■	■	■				741X12-2.0	■	■	■	■	■	□	■

7XX-XX-B



Sur demande pour serrage type B, voir page 1.03
Wahlweise mit B-Spannsystem, siehe Seite 1.03
On request for B clamping system, see page 1.03

■ = disponible / verfügbar / available

□ = selon disponibilité du stock / jenach Lagerverfügbarkeit / depending on stock availability

Tronçonnage
Abstechen
Parting off

731X25 / 741X25

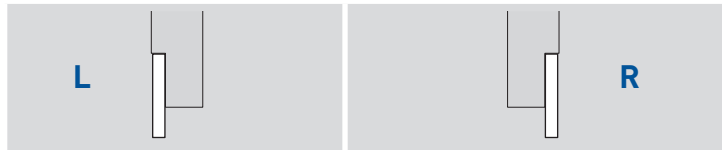
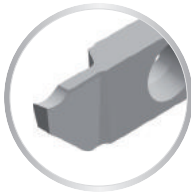
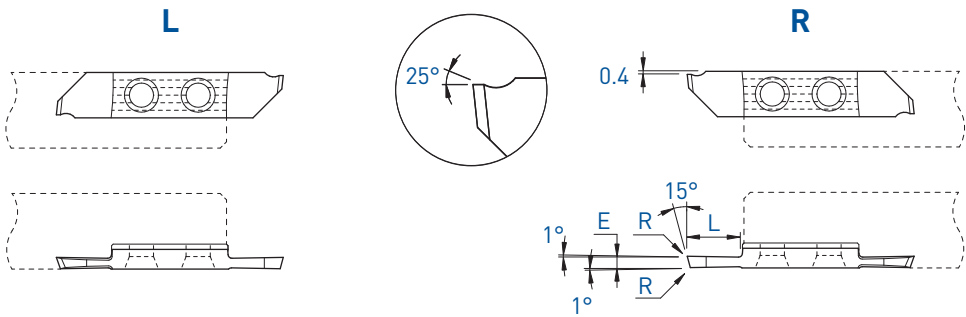

E	L	Art. N°	TiAlN	TiN	N (µk20)	HTA	HTiN	HN (µk10)	Art. N°	TiAlN	TiAlX	TiN	N (µk20)	HTA	HTiN	HN (µk10)
1.0	5	731X25-1.0	■	■	■				741X25-1.0	■		■	■	■	□	■
1.5	7	731X25-1.5	■	■	■				741X25-1.5	■		■	■	■	□	■
2.0	7	731X25-2.0	■	■	■				741X25-2.0	■	■	■	■	■	□	■

7XX-XX-B

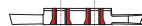

Sur demande pour serrage type B, voir page 1.03
Wahlweise mit B-Spannsystem, siehe Seite 1.03
On request for B clamping system, see page 1.03

Tronçonnage

Abstechen

Parting off

731U / 741U

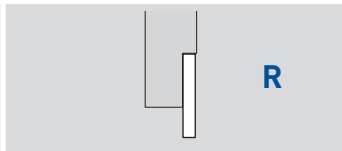
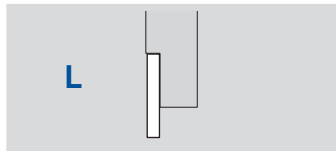
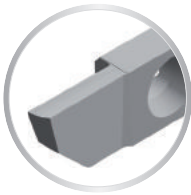
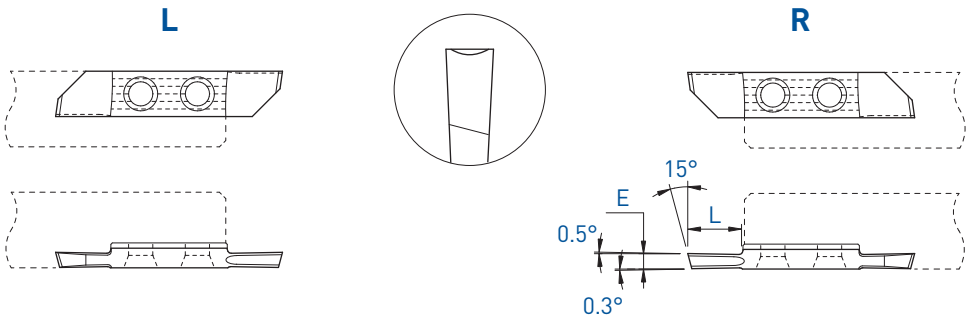

E	L	Art. N°	TiAlN	TiN	N (µm20)	HTA	HTiN	HN (µm10)	Art. N°	TiAlN	TiN	N (µm20)	HTA	HTiN	HN (µm10)
1.5	7	731U-1.5	■	■	■	■	□	■	741U-1.5	■	■	■	■	■	■
2.0	7	731U-2.0	■	■	■	■	□	■	741U-2.0	■	■	■	■	□	■

7XX-XX-B



Sur demande pour serrage type B, voir page 1.03
Wahlweise mit B-Spannsystem, siehe Seite 1.03
On request for B clamping system, see page 1.03

■ = disponible / verfügbar / available

□ = selon disponibilité du stock / jenach Lagerverfügbarkeit / depending on stock availability

Tronçonnage

Abstechen

Parting off

731N / 741N

L

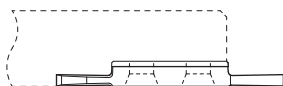
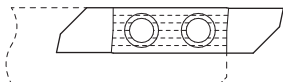

R

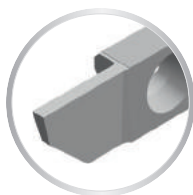
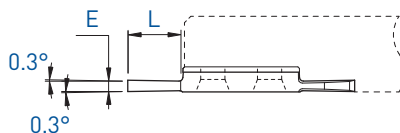
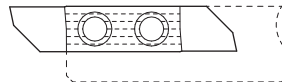

L



R



E	L	Art. N°	TiAlN	TiN	N (µk20)	HTA	HTiN	HN (µk10)	Art. N°	TiAlN	TiN	N (µk20)	HTA	HTiN	HN (µk10)
1.0	5	731N-1.0	■	■	■	■	□	■	741N-1.0	■	■	■	■	□	■
1.5	7	731N-1.5	■	■	■	■	□	■	741N-1.5	■	■	■	■	□	■

7XX-XX-B



Sur demande pour serrage type B, voir page 1.03
Wahlweise mit B-Spannsystem, siehe Seite 1.03
On request for B clamping system, see page 1.03

Tronçonnage
Abstechen
Parting off

Coupe déportée
Versetztes Schneiden
Cut off line

741L / 731R

Cut L

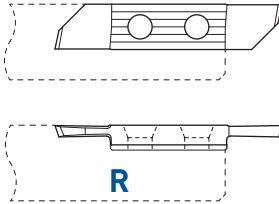

Cut R

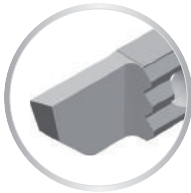
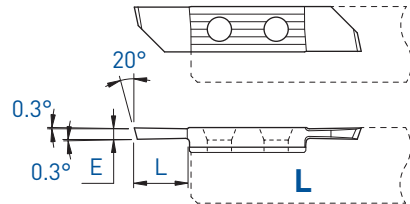

R (L)

Coupe à gauche déportée
Versetztes Linksschneiden
Left cut off line

L (R)

Coupe à droite déportée
Versetztes Rechtsschneiden
Right cut off line

E	L	Art. N°	TiAlN	TiN	N (µk20)	HTA	HTiN	HN (µk10)	Art. N°	TiAlN	TiN	N (µk20)	HTA	HTiN	HN (µk10)
1.0	5	741L-1.0	■	■	■	■	□	■	731R-1.0	■	■	■	■	■	■
1.2	5	741L-1.2	■	■	■	■	□	■	731R-1.2	■	■	■	■	□	■
1.5	7	741L-1.5	■	■	■	■	■	■	731R-1.5	■	■	■	■	■	■
2.0	7	741L-2.0	■	■	■	■	□	■	731R-2.0	■	■	■	■	□	■
2.5	7	741L-2.5	■	■	■				731R-2.5	■	■	■			

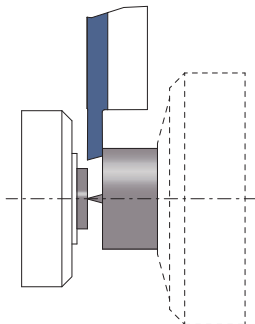

Tronçonnage
Abstechen
Parting off

Coupe déportée
Versetztes Schneiden
Cut off line

741LX4 / 731RX4

Cut L

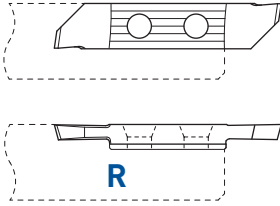

Cut R

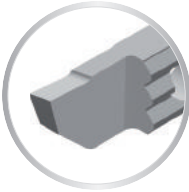
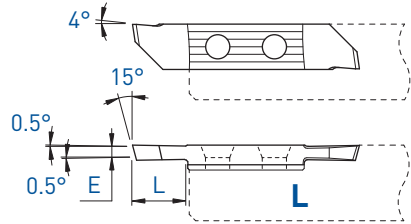

R (L)

Coupe à gauche déportée
Versetztes Linksschneiden
Left cut off line

L (R)

Coupe à droite déportée
Versetztes Rechtsschneiden
Right cut off line

E	L	Art. N°	TiAlN	TiN	N (µk20)	HTA	HTiN	HN (µk10)	Art. N°	TiAlN	TiN	N (µk20)	HTA	HTiN	HN (µk10)
1.5	5	741LX4-1.5	■	■	■				731RX4-1.5	■	■	■	■	■	■

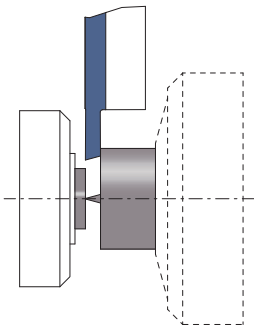

Tronçonnage
Abstechen
Parting off

Coupe déportée
Versetztes Schneiden
Cut off line

741LXF / 731RXF

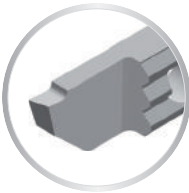
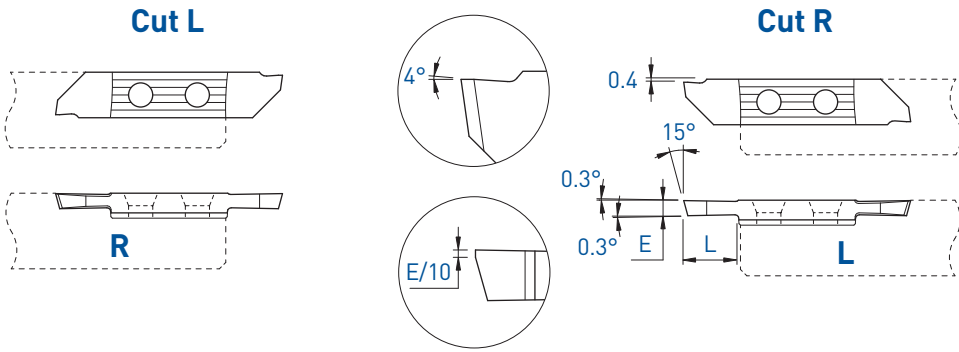

R (L)

Coupe à gauche déportée
Versetztes Linksschneiden
Left cut off line

L (R)

Coupe à droite déportée
Versetztes Rechtsschneiden
Right cut off line

E	L	Art. N°	TiAlN	TiN	N (µk20)	HTA	HTiN	HN (µk10)	Art. N°	TiAlN	TiN	N (µk20)	HTA	HTiN	HN (µk10)
1.5	7	741LXF-1.5	■	■	■				731RXF-1.5	■	■	■	■	■	■
2.0	7	741LXF-2.0	■	■	■				731RXF-2.0	■	■	■	■	□	■
2.5	7	741LXF-2.5	■	■	■				731RXF-2.5	■	■	■	■		

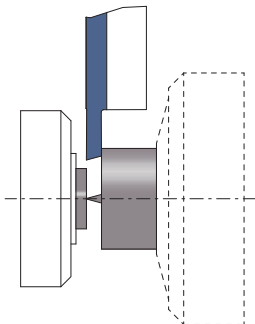

Tronçonnage
Abstechen
Parting off

Coupe déportée
Versetztes Schneiden
Cut off line

741LX12 / 731RX12

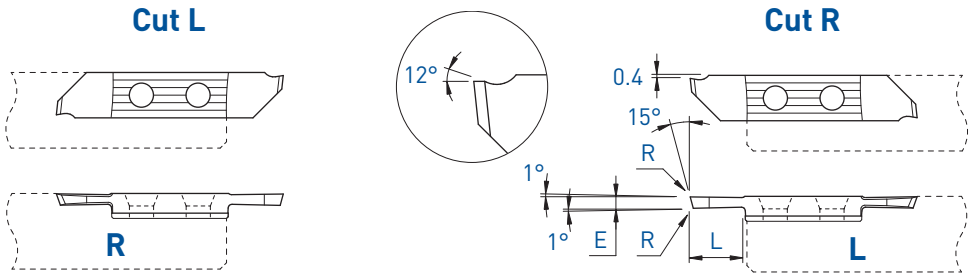

R (L)

Coupe à gauche déportée
Versetztes Linksschneiden
Left cut off line

L (R)

Coupe à droite déportée
Versetztes Rechtsschneiden
Right cut off line

E	L	R	Art. N°	TiAlN	TiN	N (µk20)	HTA	HTiN	HN (µk10)	Art. N°	TiAlN	TiN	N (µk20)	HTA	HTiN	HN (µk10)
1.0	5	0.03	-							731RX12-1.0	■	□	■			
1.5	7	0.03	741LX12-1.5	■	■	■				731RX12-1.5	■	■	■	■	■	■

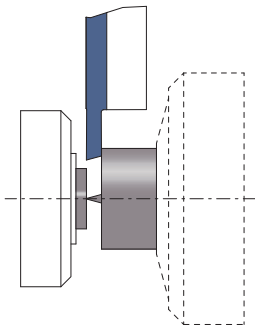

Tronçonnage
Abstechen
Parting off

Coupe déportée
Versetztes Schneiden
Cut off line

741LX25 / 731RX25

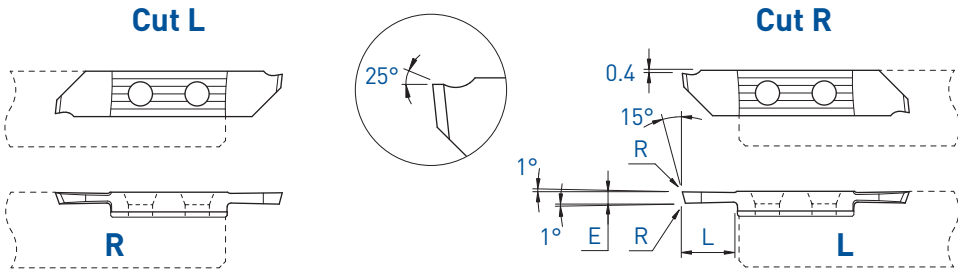

R (L)	L (R)
Coupe à gauche déportée Versetztes Linksschneiden Left cut off line	Coupe à droite déportée Versetztes Rechtsschneiden Right cut off line

E	L	R	Art. N°	TiAlN	TiN	N (µk20)	Art. N°	TiAlN	TiN	N (µk20)
1.5	7	0.03	741LX25-1.5	■	■	■	731RX25-1.5	■	■	■

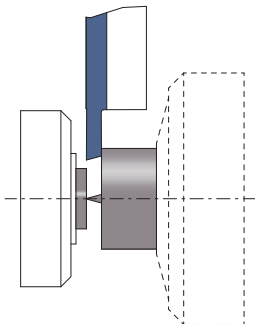

Tronçonnage

Abstechen

Parting off

Coupe déportée

Versetztes Schneiden

Cut off line

731RU

Cut R

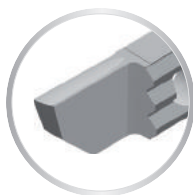
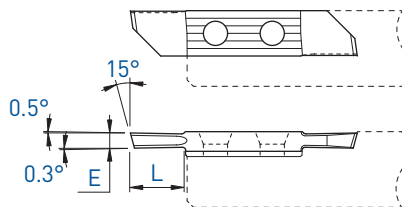
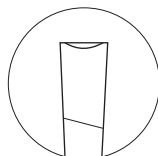

L (R)

Coupe à droite déportée
Versetztes Rechtsschneiden
Right cut off line

E	L	Art. N°	TiAlN	TiN	N (µk20)	HTA	HTiN	HN (µk10)
1.0	5	731RU-1.0	■	□	■			
1.2	5	731RU-1.2	■	□	■			
1.5	7	731RU-1.5	■	□	■	■	□	■
2.0	7	731RU-2.0	■	□	■			

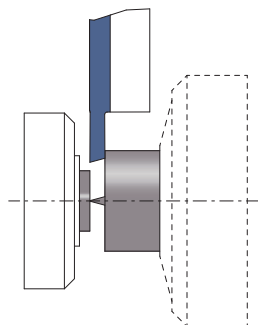

Tronçonnage
Abstechen
Parting off

Coupe déportée
Versetztes Schneiden
Cut off line

741N / 731N

Cut L

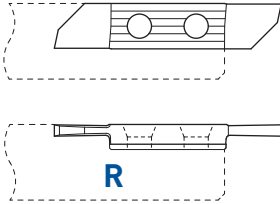

Cut R

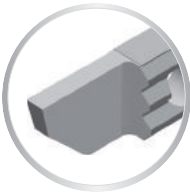
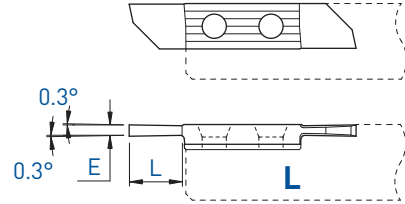

R (L)

Coupe à gauche déportée
Versetztes Linksschneiden
Left cut off line

L (R)

Coupe à droite déportée
Versetztes Rechtsschneiden
Right cut off line

E	L	Art. N°	TiAlN	TiN	N (µk20)	HTA	HTiN	HN (µk10)	Art. N°	TiAlN	TiN	N (µk20)	HTA	HTiN	HN (µk10)
1.0	5	741N-1.0	■	■	■	■	□	■	731N-1.0	■	■	■	■	□	■
1.5	7	741N-1.5	■	■	■	■	□	■	731N-1.5	■	■	■	■	□	■

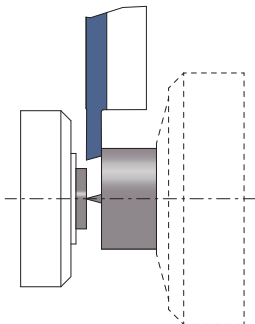

TOP-LINE

Tournage avant
Vorwärts drehen
Front turning

732 / 742

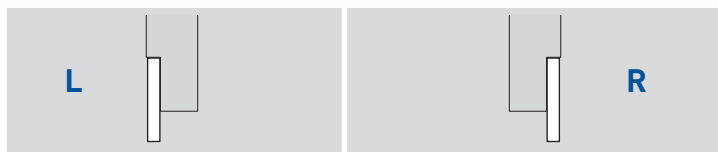
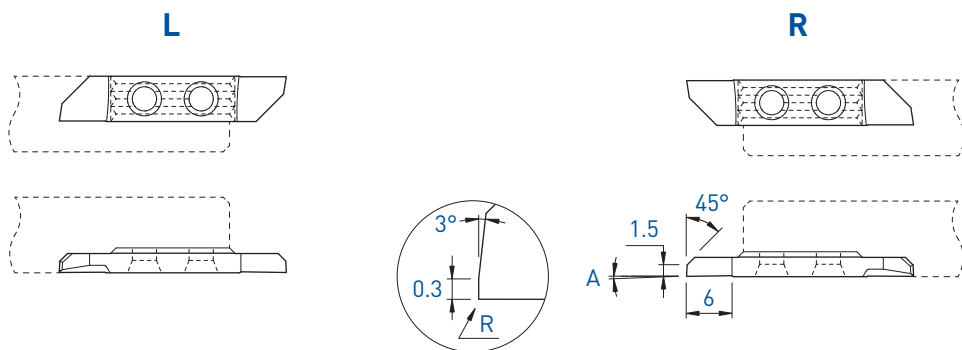

A	R	Art. N°	TiAlN	TiN	N (µk20)	HTA	HTiN	HN (µk10)	Art. N°	TiAlN	TiAlX	TiN	N (µk20)	HTA	HTiN	HN (µk10)
0°	0	732	■	■	■	■	■	■	742	■	■	■	■	■	■	■
2°	0	732-2°	■	■	■	■	□	■	742-2°	■	■	■	■	■	■	■

7XX-XX-B



Sur demande pour serrage type B, voir page 1.03
Wahlweise mit B-Spannsystem, siehe Seite 1.03
On request for B clamping system, see page 1.03

Tournage avant
Vorwärts drehen
Front turning

732PX / 742PX

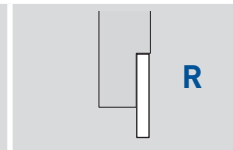
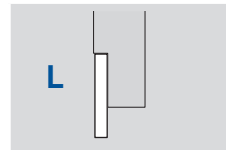
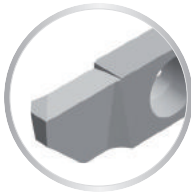
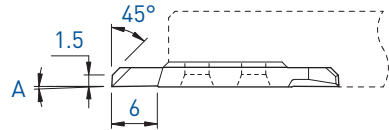
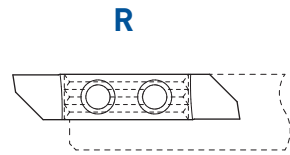
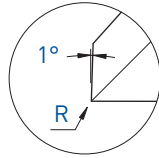
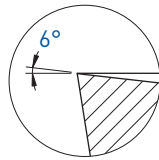
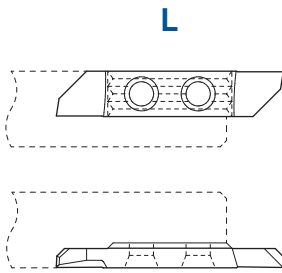

A	R	Art. N°	TiAlN	TiN	N [µk20]	Art. N°	TiAlN	TiN	N [µk20]
0°	0	732PX	■	■	■	742PX	■	■	■

7XX-XX-B

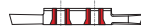

Sur demande pour serrage type B, voir page 1.03
Wahlweise mit B-Spannsystem, siehe Seite 1.03
On request for B clamping system, see page 1.03

■ = disponible / verfügbar / available
□ = selon disponibilité du stock / jenach Lagerverfügbarkeit / depending on stock availability

TOP-LINE

Tournage avant
Vorwärts drehen
Front turning

732X / 742X

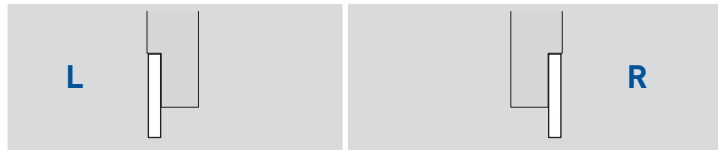
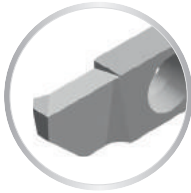
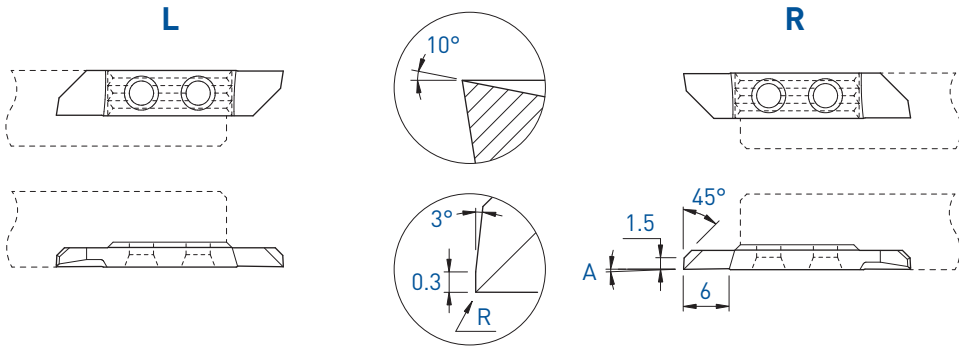

A	R	Art. N°	TiAlN	TiN	N (µk20)	HTA	HTiN	HN (µk10)	Art. N°	TiAlN	TiAlX	TiN	N (µk20)	HTA	HTiN	HN (µk10)
0°	0	732X	■	■	■	■	■	■	742X	■	■	■	■	■	■	■

7XX-XX-B



Sur demande pour serrage type B, voir page 1.03
Wahlweise mit B-Spannsystem, siehe Seite 1.03
On request for B clamping system, see page 1.03

Tournage arrière
 Rückwärts drehen
 Back turning

733 / 743

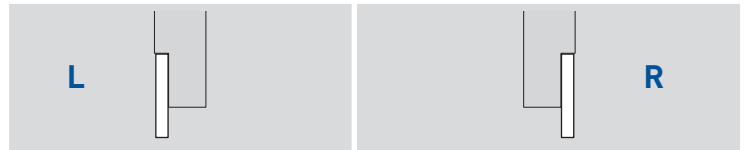
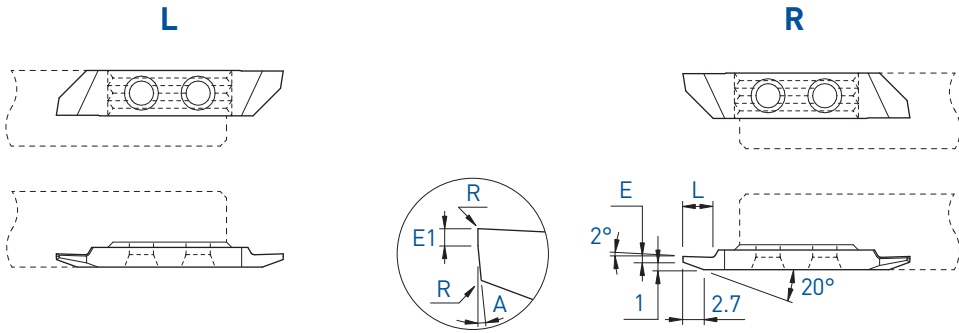

E	E1	A	L	R	Art. N°	TiAlN	TiN	N (µk20)	HTA	HTiN	HN (µk10)	Art. N°	TiAlN	TiAlX	TiN	N (µk20)	HTA	HTiN	HN (µk10)	
0.5	0.25	3°	3	0	733-0.5	■	■	■	■	□	■	743-0.5	■	■	■	■	■	■	■	■
0.5	-	2°	3	0.08	733-0.5-R08	■	■	■	■	□	■	743-0.5-R08	■	■	■	■	■	■	■	■
0.8	0.30	3°	4	0	733-0.8	■	■	■	■	□	■	743-0.8	■	■	■	■	■	■	■	■
1.0	0.40	3°	4	0	733-1.0	■	■	■	■	□	■	743-1.0	■	■	■	■	■	■	■	■
1.2	0.50	3°	5	0	733-1.2	■	■	■	■	□	■	743-1.2	■	■	■	■	■	■	■	■
1.5	0.50	3°	6	0	733-1.5	■	■	■	■	□	■	743-1.5	■	■	■	■	■	■	■	■

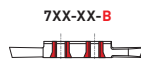

Sur demande pour serrage type B, voir page 1.03
 Wahlweise mit B-Spannsystem, siehe Seite 1.03
 On request for B clamping system, see page 1.03

■ = disponible / verfügbar / available
 □ = selon disponibilité du stock / jenach Lagerverfügbarkeit / depending on stock availability

TOP-LINE

Tournage arrière
Rückwärts drehen
Back turning

733X / 743X

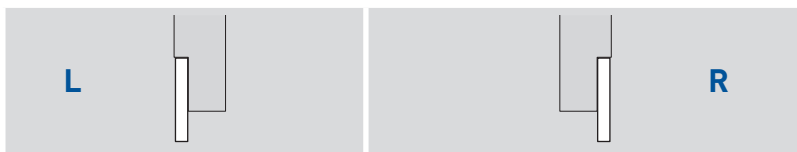
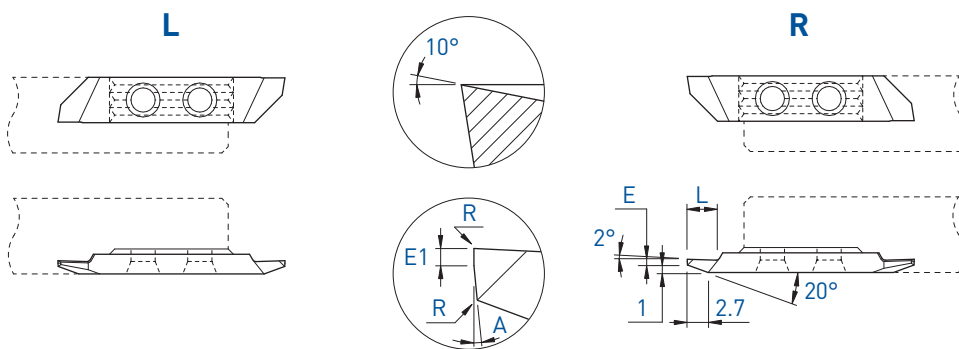

E	E1	A	L	R	Art. N°	TiAlN	TiN	N (µk20)	HTA	HTiN	HN (µk10)	Art. N°	TiAlN	TiAlX	TiN	N (µk20)	HTA	HTAX <small>new</small>	HTiN	HN (µk10)
0.5	0.25	3°	3	0	733X-0.5	■	■	■	■	□	■	743X-0.5	■	■	■	■	■	□	□	■
0.5	-	2°	3	0.08	733X-0.5-R08	■	■	■				743X-0.5-R08	■	■	■	■	■	□	□	■
0.8	0.30	3°	4	0	733X-0.8	■	■	■				743X-0.8	■		■	■			□	■
1.0	0.40	3°	4	0	733X-1.0	■	■	■				743X-1.0	■		■	■			□	■
1.2	0.50	3°	5	0	733X-1.2	■	■	■				743X-1.2	■		■	■			□	■
1.5	0.50	3°	6	0	733X-1.5	■	■	■				743X-1.5	■		■	■			□	■

7XX-XX-B



Sur demande pour serrage type B, voir page 1.03
Wahlweise mit B-Spannsystem, siehe Seite 1.03
On request for B clamping system, see page 1.03

Tournage arrière
Rückwärts drehen
Back turning

733VX-8° / 743VX-8°

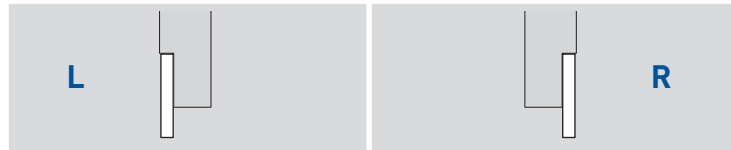
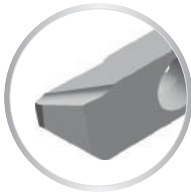
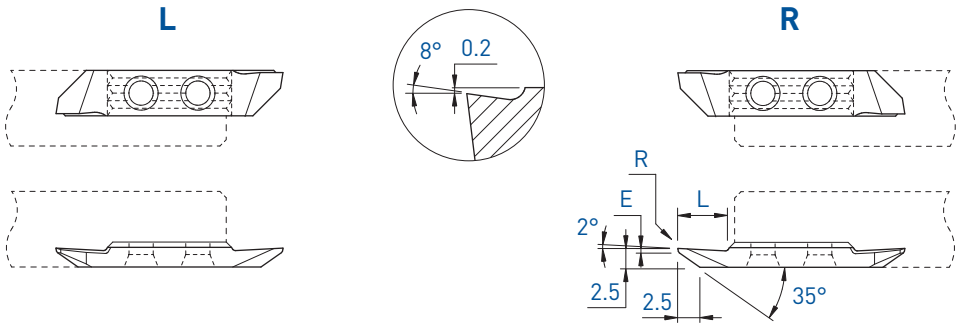

E	L	R	Art. N°	TiAlN	TiN	N (µk20)	HTA	HTiN	HN (µk10)	Art. N°	TiAlN	TiN	N (µk20)	HTA	HTiN	HN (µk10)
1.0	6.5	0	733VX-8°	■	■	■	■	■	■	743VX-8°	■	■	■	■	■	■
1.0	6.5	0.08	733VX-8°-R08	■	■	■	■	□	■	743VX-8°-R08	■	■	■	■	□	■

7XX-XX-B



Sur demande pour serrage type B, voir page 1.03
Wahlweise mit B-Spannsystem, siehe Seite 1.03
On request for B clamping system, see page 1.03

■ = disponible / verfügbar / available
□ = selon disponibilité du stock / jenach Lagerverfügbarkeit / depending the stock availability

Tournage arrière
Rückwärts drehen
Back turning

733VX-805 / 743VX-805

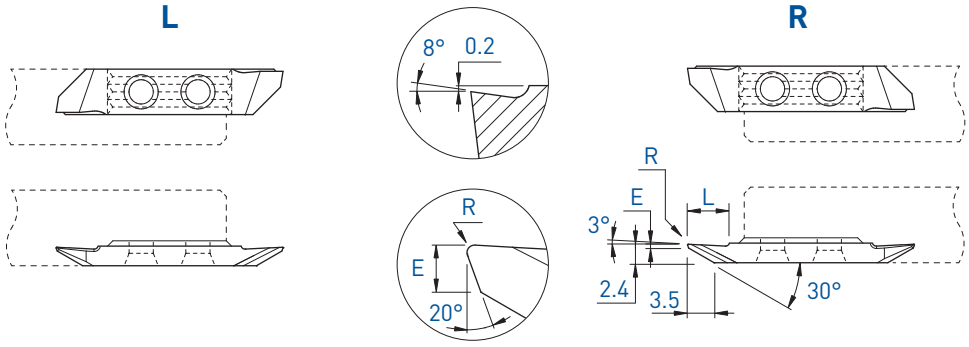

E	L	R	Art. N°	TiAlN	TiN	N (µk20)	HTA	HTiN	HN (µk10)	Art. N°	TiAlN	TiN	N (µk20)	HTA	HTiN	HN (µk10)
0.5	6	0.08	733VX-805-R08	■	□	■	■	□	■	743VX-805-R08	■	■	■	■	□	■

7XX-XX-B



Sur demande pour serrage type B, voir page 1.03
 Wahlweise mit B-Spannsystem, siehe Seite 1.03
 On request for B clamping system, see page 1.03

Tournage arrière
 Rückwärts drehen
 Back turning

733VX-15° / 743VX-15°

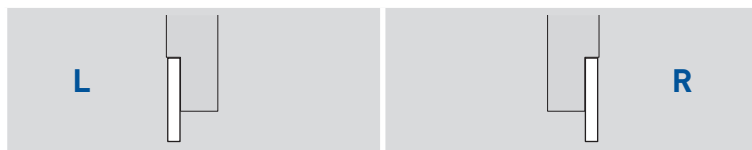
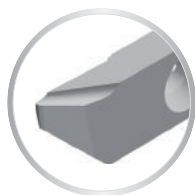
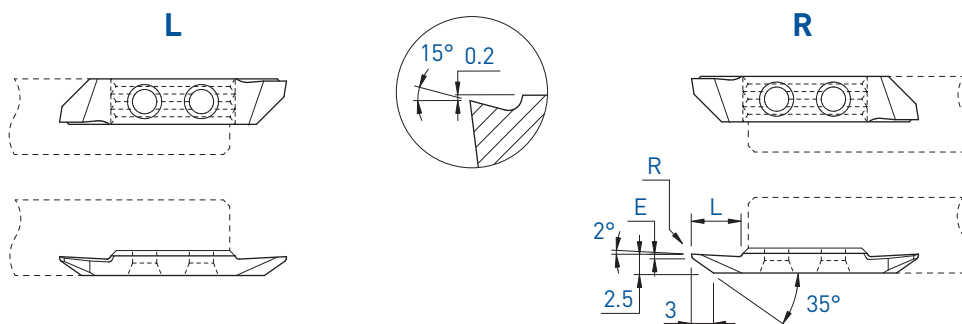

E	L	R	Art. N°	TiAlN	TiN	N (µk20)	HTA	HTiN	HN (µk10)	Art. N°	TiAlN	TiN	N (µk20)	HTA	HTiN	HN (µk10)
0.5	6.5	0	733VX-15°	■	■	■	■	□	■	743VX-15°	■	■	■	■	□	■
0.5	6.5	0.08	733VX-15°-R08	■	■	■				743VX-15°-R08	■	■	■	■	□	■

7XX-XX-B



Sur demande pour serrage type B, voir page 1.03
 Wahlweise mit B-Spannsystem, siehe Seite 1.03
 On request for B clamping system, see page 1.03

■ = disponible / verfügbar / available
 □ = selon disponibilité du stock / jenach Lagerverfügbarkeit / depending on stock availability

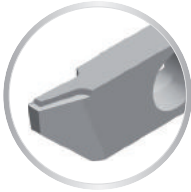
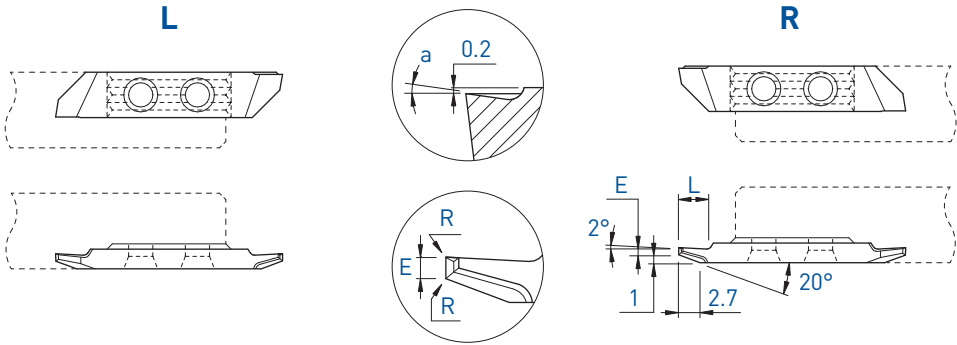

Pour un meilleur contrôle des copeaux
Für eine bessere Spankontrolle
For a better chip-control

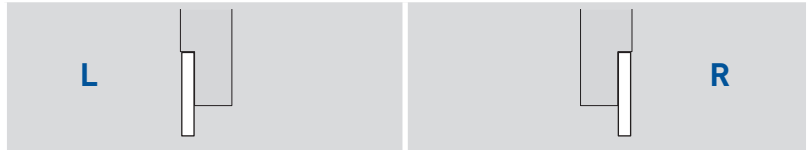

a	E	L	R	L						R						
				Art. N°	TiAlN	TiN	N (µk20)	HTA	HTiN	HN (µk10)	Art. N°	TiAlN	TiN	N (µk20)	HTA	HTiN
10°	1.0	4	0.01	733ZX10-1.0	■	□						743ZX10-1.0	■	□	■	□
	1.0	4	0.08	733ZX10-1.0-R08	■	□						743ZX10-1.0-R08	■	□	■	□

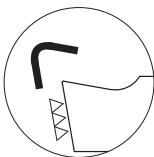

Arête de coupe honée
Gehonte Schneidkante
Honed edge

f min: 0.02 mm/U



7XX-XX-B

Sur demande pour serrage type B, voir page 1.03
Wahlweise mit B-Spannsystem, siehe Seite 1.03
On request for B clamping system, see page 1.03

Tournage arrière / pré-coupe
 Rückwärts drehen / vorstechen
 Back turning / pre-parting off

733P / 743P

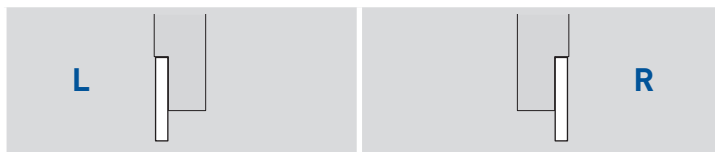
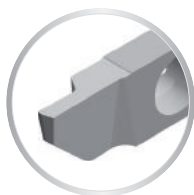
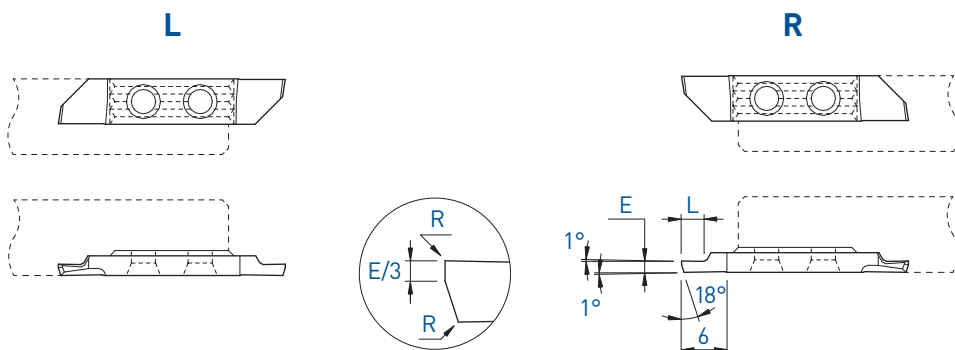

E	L	R	Art. N°	L			R									
				TiAlN	TiN	N (μk20)	HTA	HTiN	HN (μk10)	Art. N°	TiAlN	TiN	N (μk20)	HTA	HTiN	HN (μk10)
0.8	2	0	733P-0.8	■	■	■				743P-0.8	■	■	■	■	□	■
1.0	2	0	733P-1.0	■	■	■				743P-1.0	■	■	■			
1.2	2.5	0	733P-1.2	■	■	■				743P-1.2	■	■	■			
1.5	3	0	733P-1.5	■	■	■				743P-1.5	■	■	■			

7XX-XX-B



Sur demande pour serrage type B, voir page 1.03
 Wahlweise mit B-Spannsystem, siehe Seite 1.03
 On request for B clamping system, see page 1.03

■ = disponible / verfügbar / available
 □ = selon disponibilité du stock / jenach Lagerverfügbarkeit / depending on stock availability

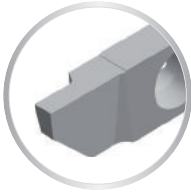
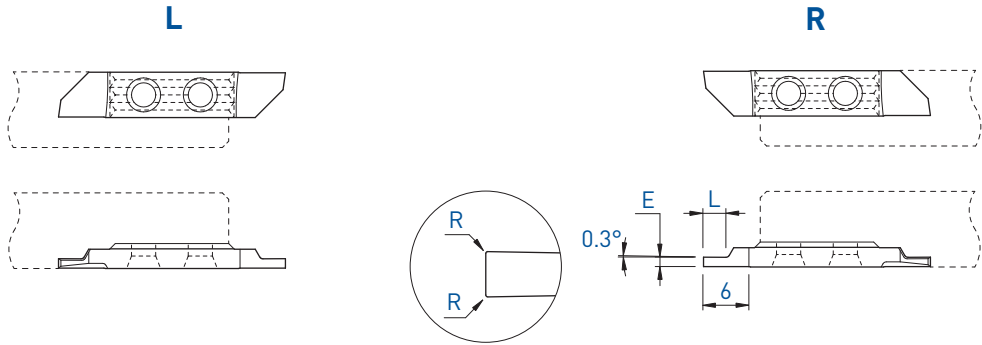

E	L	R	Art. N°	TiAlN	TiN	N (µk20)	HTA	HTiN	HN (µk10)	Art. N°	TiAlN	TiAlX	TiN	N (µk20)	HTA	HTAX	HTiN	HN (µk10)
0.5	1.5	0	734-0.5	■	■	■	■	□	■	744-0.5	■	■	■	■	■	■	■	■
0.6	1.8	0	734-0.6	■	■	■	■	□	■	744-0.6	■	■	■	■	■	■	□	■
0.75	2	0	734-0.75	■	■	■	■	■	■	744-0.75	■	■	■	■	■	■	■	■
0.8	2	0	734-0.8	■	■	■	■	□	■	744-0.8	■	■	■	■	■	■	□	■
0.8	2	0.08	-							744-0.8-R08	■	■	■	■	■	■	□	■
0.9	2.5	0	-							744-0.9	■	■	■	■	■	■	□	■
0.95	3	0	734-0.95	■	■	■	■	■	■	744-0.95	■	■	■	■	■	■	□	■
1.0	2.5	0	734-1.0	■	■	■	■	■	■	744-1.0	■	■	■	■	■	■	■	■
1.0	2.5	0.08	734-1.0-R08	■	■	■	■	■	■	744-1.0-R08	■	■	■	■	■	■	□	■
1.2	3	0	734-1.2	■	■	■	■	□	■	744-1.2	■	■	■	■	■	■	■	■
1.5	3	0	734-1.5	■	■	■	■	■	■	744-1.5	■	■	■	■	■	■	■	■
1.5	3	0.08	734-1.5-R08	■	■	■	■	□	■	744-1.5-R08	■	■	■	■	■	■	□	■
1.5	3	0.15	-							744-1.5-R15	■	■	□	■	■	■	□	■
1.5	3	0.20	-							744-1.5-R20	■	■	■	■	■	■	□	■
1.8	4	0	734-1.8	■	■	■	■	□	■	744-1.8	■	■	■	■	■	■	□	■
2.0	4	0	734-2.0	■	■	■	■	□	■	744-2.0	■	■	■	■	■	■	□	■
2.0	4	0.08	734-2.0-R08	■	■	■	■	□	■	744-2.0-R08	■	■	■	■	■	■	□	■
2.0	4	0.15	-							744-2.0-R15	■	■	□	■	■	■	□	■
2.0	4	0.20	-							744-2.0-R20	■	■	■	■	■	■	□	■
2.5	6	0	734-2.5	■	■	■	■	■	■	744-2.5	■	■	■	■	■	■	□	■

7XX-XX-B



Sur demande pour serrage type B, voir page 1.03
Wahlweise mit B-Spannsystem, siehe Seite 1.03
On request for B clamping system, see page 1.03

Fonçage-tournage

Einstecken und drehen

Grooving and turning

734VS / 744VS

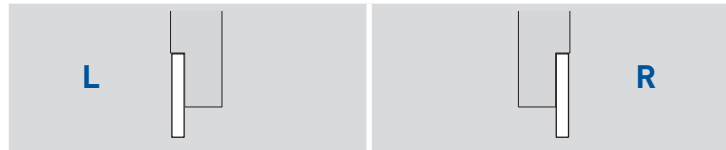
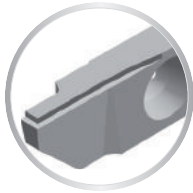
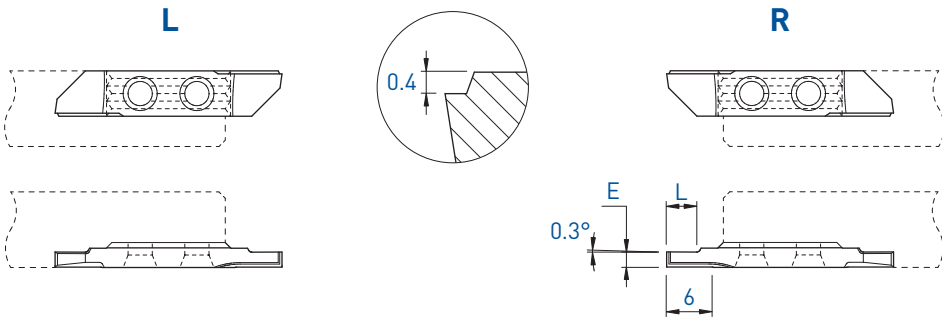

E	L	Art. N°	L			R			Art. N°	R					
			TiAlN	TiN	N (µk20)	HTA	HTiN	HN (µk10)		TiAlN	TiN	N (µk20)	HTA	HTiN	HN (µk10)
1.0	2	734VS-1.0	■	■	■	■	□	■	744VS-1.0	■	■	■	■	□	■
1.2	2.5	734VS-1.2	■	■	■	■	□	■	744VS-1.2	■	■	■	■	□	■
1.5	3	734VS-1.5	■	■	■	■	□	■	744VS-1.5	■	■	■	■	□	■
1.8	4	734VS-1.8	■	■	■				744VS-1.8	■	■	■			
2.0	4	734VS-2.0	■	■	■				744VS-2.0	■	■	■	■	□	■
2.5	6	734VS-2.5	■	■	■				744VS-2.5	■	■	■			

7XX-XX-B



Sur demande pour serrage type B, voir page 1.03
Wahlweise mit B-Spannsystem, siehe Seite 1.03
On request for B clamping system, see page 1.03

■ = disponible / verfügbar / available
□ = selon disponibilité du stock / jenach Lagerverfügbarkeit / depending on stock availability

TOP-LINE

Fonçage-tournage
Einstecken und drehen
Grooving and turning

734X / 744X

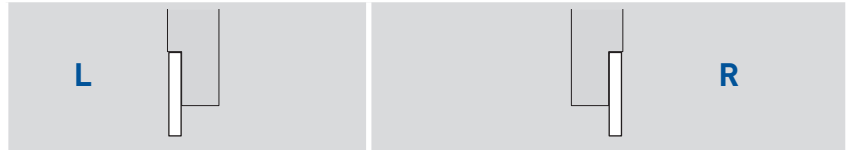
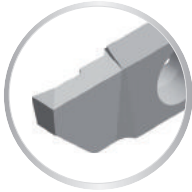
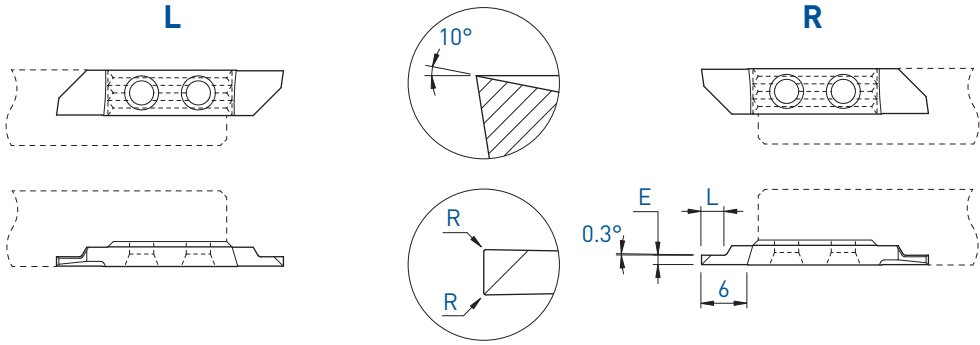

E	L	R	Art. N°	L			R			Art. N°	L			R				
				TiAlN	TiN	N (µk20)	HTA	HTIN	HN (µk10)		TiAlN	TiAlX	LoX	TiN	N (µk20)	HTA	HTAX	HTIN
0.8	2	0	734X-0.8	■	■	■	■	□	■	744X-0.8	■	■	■	■	■	■	■	■
1.0	2.5	0	734X-1.0	■	■	■	■	□	■	744X-1.0	■	■	■	■	■	■	■	■
1.0	2.5	0.08	734X-1.0-R08	■	■	■	■	□	■	744X-1.0-R08	■	■	■	■	■	■	□	■
1.2	3	0	734X-1.2	■	■	■	■	□	■	744X-1.2	■	■	■	■	■	■	□	■
1.5	3	0	734X-1.5	■	■	■	■	■	■	744X-1.5	■	■	■	■	■	■	■	■
1.5	3	0.08	734X-1.5-R08	■	■	■	■	□	■	744X-1.5-R08	■	■	■	■	■	■	□	■
1.5	3	0.15	-							744X-1.5-R15	■	■	□	■	■	■	□	■
1.5	3	0.20	-							744X-1.5-R20	■	■	■	■	■	■	□	■
1.8	4	0	734X-1.8	■	■	■				744X-1.8	■	■	■	■	■	■	□	■
2.0	4	0	734X-2.0	■	■	■	■	□	■	744X-2.0	■	■	■	■	■	■	■	■
2.0	4	0.08	734X-2.0-R08	■	■	■	■	□	■	744X-2.0-R08	■	■	■	■	■	■	■	■
2.0	4	0.15	-							744X-2.0-R15	■	■	□	■	■	■	□	■
2.0	4	0.20	734X-2.0-R20	■	■	■	■	□	■	744X-2.0-R20	■	■	■	■	■	■	□	■
2.5	6	0	734X-2.5	■	■	■	■	□	■	744X-2.5	■	■	■	■	■	■	□	■

7XX-XX-B



Sur demande pour serrage type B, voir page 1.03
Wahlweise mit B-Spannsystem, siehe Seite 1.03
On request for B clamping system, see page 1.03

Fonçage-tournage

Einstecken und drehen

Grooving and turning

734ZX / 744ZX

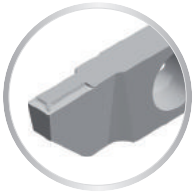
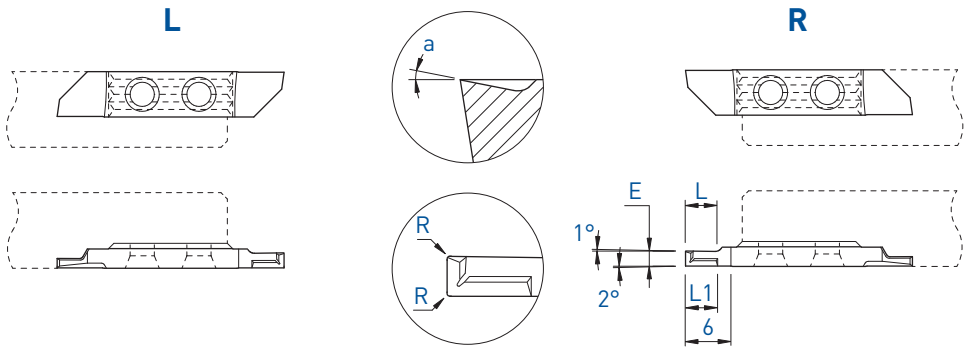

Pour un meilleur contrôle des copeaux
Für eine bessere Spankontrolle
For a better chip-control



a	E	L	L1	R	Art. N°	TiAlN				Art. N°								
						TiN	TiN	N (µk20)	HTA	HAS	HTiN	HN (µk10)	TiAlN	TiAlX	TiN	N (µk20)	HTA	HAS
10°	1.0	2.5	3	0.01	734ZX10-1.0	■	■					744ZX10-1.0	■	■	■	■		□
	1.5	4	4	0.01	734ZX10-1.5	■	■					744ZX10-1.5	■	■	□	■		■
	1.5	4	4	0.08	734ZX10-1.5-R08	■	■					744ZX10-1.5-R08	■	■	■	■		
	2.0	4	4	0.01	734ZX10-2.0	■	■					744ZX10-2.0	■	■	□	■		□
	2.0	4	4	0.08	734ZX10-2.0-R08	■	■					744ZX10-2.0-R08	■	■	□	■		
	2.5	6	4	0.01	734ZX10-2.5	■	■					744ZX10-2.5	■	■	□	■		□
	2.5	6	4	0.08	-							744ZX10-2.5-R08	■	■	□	■		
17°	1.0	2.5	3	0.01	-							744ZX17-1.0				■	■	

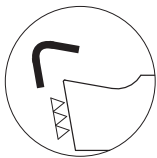

Arête de coupe honée
Gehonte Schneidkante
Honed edge

f min: 0.02 mm/U

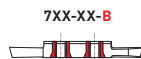

7XX-XX-B
Sur demande pour serrage type B, voir page 1.03
Wahlweise mit B-Spannsystem, siehe Seite 1.03
On request for B clamping system, see page 1.03

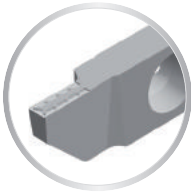
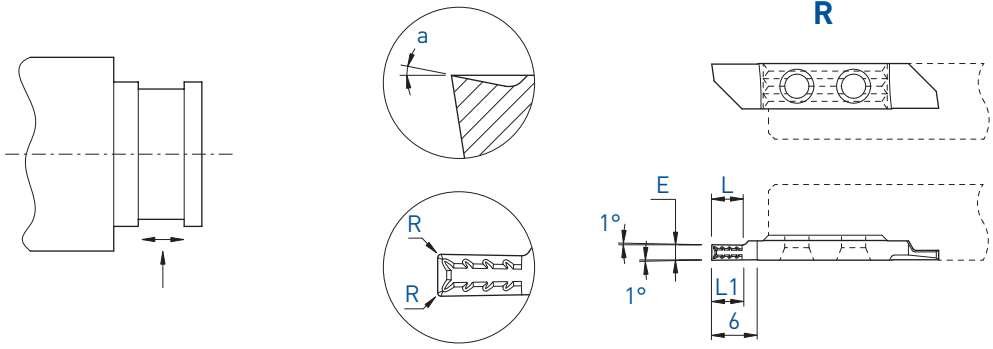

Pour un meilleur contrôle des copeaux
 Für eine bessere Spankontrolle
 For a better chip-control

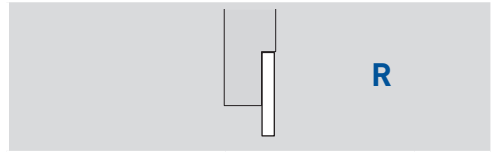

a	E	L	L1	R	Art. N°	TiAIN	TiAlX	LOX	TiN	N (µk20)	HTA	HTiN	HN (µk10)
10°	1.0	2.5	2.5	0.01	744ZXT10-1.0	■	■	■	■		■	□	
	1.5	4	4	0.01	744ZXT10-1.5	■	■	■	□		■	□	
	1.5	4	4	0.08	744ZXT10-1.5-R08	■	■	■	■		■	□	
	2.0	4	4	0.01	744ZXT10-2.0	■	■	■	□		■	□	
	2.0	4	4	0.08	744ZXT10-2.0-R08	■	■	■	□		■	□	
	2.5	5	5	0.01	744ZXT10-2.5	■	■	■	□		■	□	
	2.5	5	5	0.08	744ZXT10-2.5-R08	■	■	■	□		■	□	



Arête de coupe honée
 Gehonte Schneidkante
 Honed edge

f min: 0.02 mm/U



Sur demande pour serrage type B, voir page 1.03
 Wahlweise mit B-Spannsystem, siehe Seite 1.03
 On request for B clamping system, see page 1.03

Gorges
Einstechen
Grooving

735 / 745

L

R

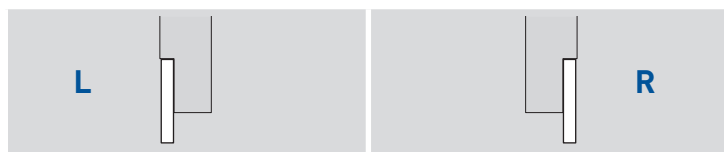
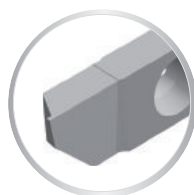
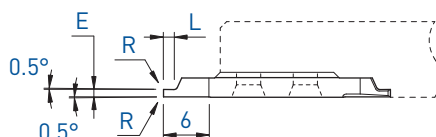
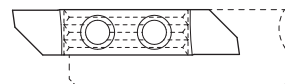
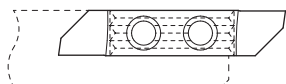

E ± 0.01			Art. N°	L			R						
	L	R		TiAlN	TiN	N (µk20)	TiAlN	TiN	N (µk20)				
0.2	0.2	0	735-0202	■	■	■							
0.3	0.3	0	735-0303	■	■	■					■	□	■
0.4	0.4	0	735-0404	■	■	■					■	□	■

7XX-XX-B



Sur demande pour serrage type B, voir page 1.03
Wahlweise mit B-Spannsystem, siehe Seite 1.03
On request for B clamping system, see page 1.03

■ = disponible / verfügbar / available
□ = selon disponibilité du stock / jenach Lagerverfügbarkeit / depending on stock availability

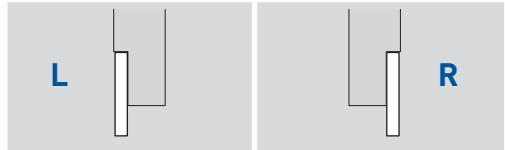
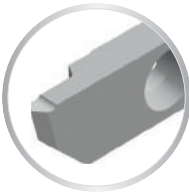
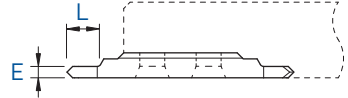
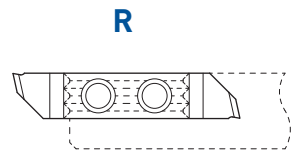
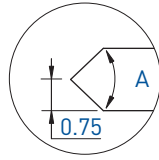
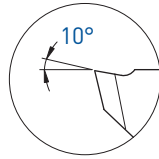
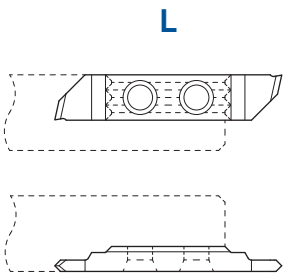

A	E	L	Art. N°	TiAIN	TiN	N (µk20)	Art. N°	TiAIN	TiN	N (µk20)
90°	1.5	4	735X-90-1.5	□	□	□	745X-90-1.5	■	□	■

7XX-XX-B



Sur demande pour serrage type B, voir page 1.03
Wahlweise mit B-Spannsystem, siehe Seite 1.03
On request for B clamping system, see page 1.03

Filetage

Gewinde drehen

Threading

736 / 746

L

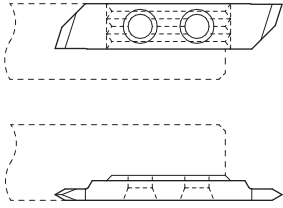

R

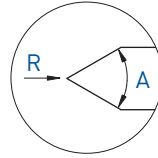
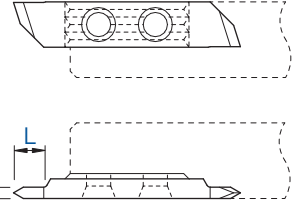

Profil partiel
Teilprofil
Partial profile

L



R



A	E	L	R	Art. N°	TiAlN	TiN	N (µk20)	HTA	HTiN	HN (µk10)	Art. N°	TiAlN	TiN	N (µk20)	HTA	HTiN	HN (µk10)
60°	1.5	4	0	736-60-1.5	■	■	■				746-60-1.5	■	■	■			
60°	1.5	4	0.02	736-60-1.5-R02	■	■	■	■	■	■	746-60-1.5-R02	■	■	■	■	□	■
60°	2.0	6	0	736-60-2.0	■	■	■				746-60-2.0	■	■	■			
60°	2.0	6	0.02	736-60-2.0-R02	■	■	■	■	■	■	746-60-2.0-R02	■	■	■	■	■	■
55°	1.5	4	0	736-55-1.5	■	■	■				746-55-1.5	■	■	■			
55°	1.5	4	0.02	736-55-1.5-R02	■	■	■				746-55-1.5-R02	■	■	■			
55°	2.0	6	0	736-55-2.0	■	■	■				746-55-2.0	■	■	■			
55°	2.0	6	0.02	736-55-2.0-R02	■	■	■				746-55-2.0-R02	■	■	■			

7XX-XX-B

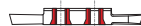

Sur demande pour serrage type B, voir page 1.03
Wahlweise mit B-Spannsystem, siehe Seite 1.03
On request for B clamping system, see page 1.03

■ = disponible / verfügbar / available
□ = selon disponibilité du stock / jenach Lagerverfügbarkeit / depending on stock availability

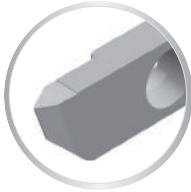
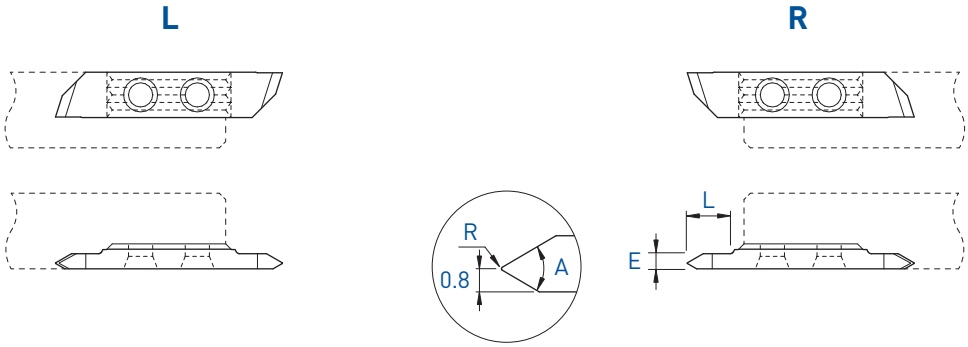

Profil partiel
Teilprofil
Partial profile



A	E	L	R	Pas Steigung Pitch P	Art. N°	TiAlN	TiN	N (µk20)	HTA	HTiN	HN (µk10)	Art. N°	TiAlN	TiN	N (µk20)	HTA	HTiN	HN (µk10)
60°	2.0	6	0.06	0.50-1.50	736-A60°	■	■	■				746-A60°	■	■	■	■	□	■

Plaquettes de filetage avec coupe positive 2°, voir page 1.126
WSP Gewindedrehen mit positivem Schnitt 2°, siehe Seite 1.126
Threading inserts with positive cut 2°, see page 1.126

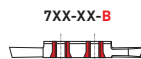

Sur demande pour serrage type B, voir page 1.03
Wahlweise mit B-Spannsystem, siehe Seite 1.03
On request for B clamping system, see page 1.03

Filetage

Gewinde drehen

Threading

736-M / 746-M

L

R

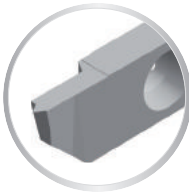
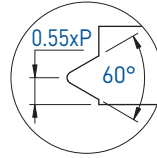
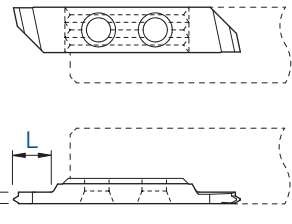
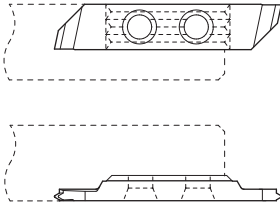

Profil complet métrique
Metrisches Vollprofil
Metric full profile

L

R

Pas Steigung Pitch P	E	L	L			R				
			Art. N°	TiAIN	TiN	N (µk20)	Art. N°	TiAIN	TiN	N (µk20)
0.25	1.0	3	736-M-0.25	■	■	■	746-M-0.25	■	■	■
0.30	1.0	3	736-M-0.30	■	■	■	746-M-0.30	■	■	■
0.35	1.0	3	736-M-0.35	■	■	■	746-M-0.35	■	■	■
0.40	1.0	3	736-M-0.40	■	■	■	746-M-0.40	■	■	■
0.45	1.0	3	736-M-0.45	■	■	■	746-M-0.45	■	■	■
0.50	1.0	3	736-M-0.50	■	■	■	746-M-0.50	■	■	■
0.60	1.0	3	736-M-0.60	■	■	■	746-M-0.60	■	■	■
0.70	1.0	3	736-M-0.70	■	■	■	746-M-0.70	■	■	■
0.75	1.0	3	736-M-0.75	■	■	■	746-M-0.75	■	■	■
0.80	1.5	4.5	736-M-0.80	■	■	■	746-M-0.80	■	■	■
1.00	1.5	4.5	736-M-1.00	■	■	■	746-M-1.00	■	■	■
1.25	1.5	4.5	736-M-1.25	■	■	■	746-M-1.25	■	■	■
1.50	2.0	6	736-M-1.50	■	■	■	746-M-1.50	■	■	■
1.75	2.0	6	736-M-1.75	■	■	■	746-M-1.75	■	■	■

Plaquettes de filetage avec coupe positive 2°, voir page 1.127
WSP Gewindedrehen mit positivem Schnitt 2°, siehe Seite 1.127
Threading inserts with positive cut 2°, see page 1.127



Sur demande pour serrage type B, voir page 1.03
Wahlweise mit B-Spannsystem, siehe Seite 1.03
On request for B clamping system, see page 1.03

■ = disponible / verfügbar / available
□ = selon disponibilité du stock / jenach Lagerverfügbarkeit / depending on stock availability

L

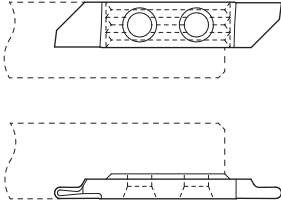

R

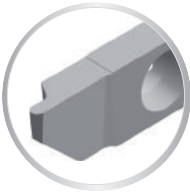
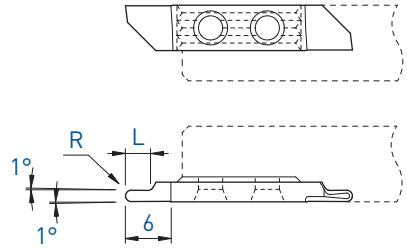

R	L	Art. N°	TiAlN			Art. N°	TiAlN		
			TiN	TiN	N (µm20)		TiN	TiN	N (µm20)
0.25	1.5	-				747-R0.25	■	■	■
0.40	2	-				747-R0.4	■	■	■
0.50	2.5	737-R0.5	■	■	■	747-R0.5	■	■	■
0.60	2.5	737-R0.6	■	■	■	747-R0.6	■	■	■
0.75	3	737-R0.75	■	■	■	747-R0.75	■	■	■
0.80	3	737-R0.8	■	■	■	747-R0.8	■	■	■
1.00	4	737-R1.0	■	■	■	747-R1.0	■	■	■

7XX-XX-B



Sur demande pour serrage type B, voir page 1.03
 Wahlweise mit B-Spannsystem, siehe Seite 1.03
 On request for B clamping system, see page 1.03

Plaquettes ébauches
WSP-Rohlinge
Blank inserts

731-E / 741-E
731-EP / 741-EP

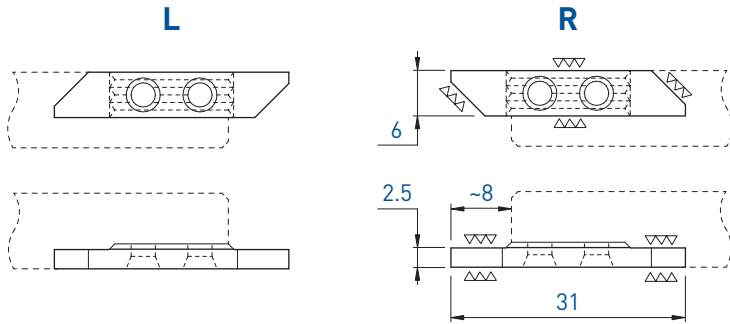
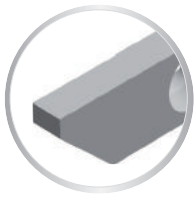

L		R			
Art. N°	N (µk20)	HN (µk10)	Art. N°	N (µk20)	HN (µk10)
731-E	■	■	741-E	■	■

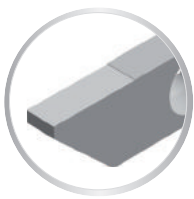

Face de coupe polie
Polierte Schneidfläche
Polished cutting face

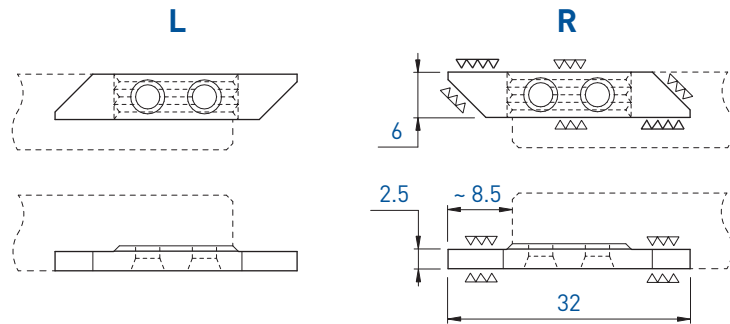

L		R											
Art. N°	TiAlN	TiN	N (µk20)	HTA	HTiN	HN (µk10)	Art. N°	TiAlN	TiN	N (µk20)	HTA	HTiN	HN (µk10)
731-EP	■	■	■	■	■	■	741-EP	■	■	■	■	□	■

7XX-XX-B



Sur demande pour serrage type B,
voir page 1.03
Wahlweise mit B-Spannsystem,
siehe Seite 1.03
On request for B clamping system,
see page 1.03

■ = disponible / verfügbar / available
□ = selon disponibilité du stock / jenach Lagerverfügbarkeit / depending on stock availability

L			R		
Type		Page	Type		Page
750	750	1.70	760	760	1.70
	750-JET	1.71		760/750-D	1.75/1.76
	750RC	1.72		760/750-AX	1.77
751	751	1.78	760-JET	1.71	
	751-E	1.131	760LC	1.73	
	751NXF	1.87/1.97	760-NOVIBRA	1.74	
	751R	1.88	761	761	1.78
	751-R05	1.80		761-E	1.131
	751RAS	1.99		761L	1.88
	751RD	1.98		761LD	1.98
	751R-R05	1.90		761L-R05	1.90
	751RS	1.89		761LS	1.89
	751RU	1.95		761LX12	1.93
	751RZU	1.96		761LX25	1.94
	751RX12	1.93		761LX4	1.91
	751RX25	1.94		761LXF	1.92
	751RX4	1.91		761NXF	1.87/1.97
	751RXF	1.92		761-R05	1.80
	751S	1.79		761S	1.79
	751U	1.85		761U	1.85
	751X12	1.83		761ZU	1.86
	751X25	1.84		761X12	1.83
	751X4	1.81		761X25	1.84
751XF	1.82	761X4		1.81	
752	752	1.100		761XF	1.82
	752PX	1.101		762	762
	752S	1.106	762PX		1.101
	752X	1.102	762S		1.105
753	753	1.107	762X		1.102
	753P	1.116	762VX-800	1.103	
	753S	1.106	762ZX	1.104	
	753VX-15°	1.113	763	763	1.107
	753VX-8°	1.110		763P	1.116
	753VX-805	1.111		763S	1.106
	753X	1.108		763VUX	1.114
	753XS	1.109		763VX-15°	1.113
	753ZX10	1.115		763VX-8°	1.110
	754	754		1.117	763VX-800
754VS		1.118		763VX-805	1.111
754X		1.119		763X	1.108
754ZX		1.122		763XS	1.109
756	754ZXT	1.124	763ZX10	1.115	
	756-55	1.125	764	764	1.117
	756-60	1.125		764VS	1.118
	756-AG60°	1.126		764X	1.119
	756-G60°	1.126		764X5	1.120
756-M	1.127	764X10		1.121	
757	757	1.129	764ZX	1.122	
	757ZX	1.130	764ZXB	1.123	
			764ZXT	1.124	
			766	766	1.125
				766-AG60°	1.126
				766-G60°	1.126
				766-M	1.127
				766ZX	1.128
			767	767	1.129
				767ZX	1.130

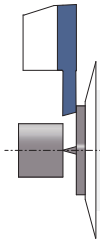
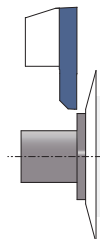
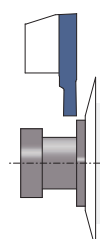
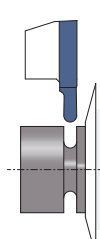
		750 / 760 Porte-outils Halter Holders	> 1.70
	751 / 761 Tronçonnage Abstechen Parting off		> 1.78
		761L / 751R Tronçonnage - coupe déportée Abstechen - versetztes Schneiden Parting off - cut off line	> 1.88
	752 / 762 Tournage avant Vorwärts drehen Front turning		> 1.100
		753 / 763 Tournage arrière Rückwärts drehen Back turning	> 1.106
	754 / 764 Fonçage-tournage Einstecken und drehen Grooving and turning		> 1.117
		756 / 766 Filetage Gewinde drehen Threading	> 1.125
	757 / 767 Plaquettes à rayon Radius Wendeplatten Radius inserts		> 1.129
		Plaquettes ébauches WSP-Rohlinge Blank inserts	> 1.131

L

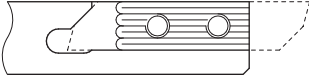

R

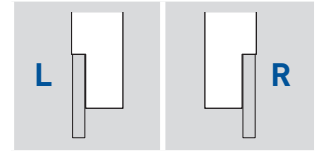
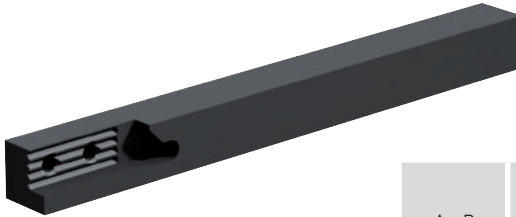
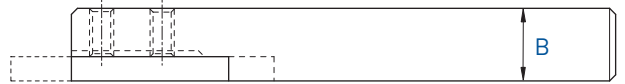
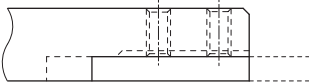
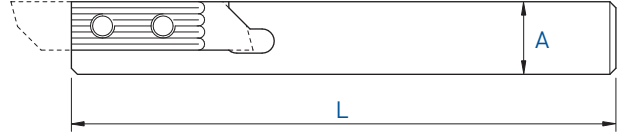

Serrage standard A
Standard Spannsystem A
Standard clamping system A

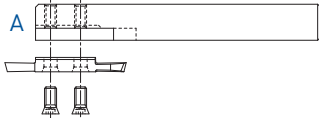

A x B	L	Serrage Spannsystem Clamping	Art. N°	Art. N°
10 x 10	115	A	750-10	760-10
10 x 10	115	A + B	750-10-AB	760-10-AB
10 x 10	50	A	750-10-50	760-10-50
12 x 12	130	A	750-12	760-12
12 x 12	130	A + B	750-12-AB	760-12-AB
12 x 12	90	A	750-12-90	760-12-90
12 x 12	90	A + B	750-12-90-AB	760-12-90-AB
12.7 x 12.7	130	A + B	750-12.7	760-12.7
14 x 14	130	A + B	750-14	760-14
16 x 16	130	A + B	750-16	760-16
16 x 16	75	A + B	750-16-75	760-16-75
20 x 20	120	A + B	750-20	760-20
25 x 25	140	A	760/750-25	

Serrage A + B
Spannsystem A + B
Clamping system A + B

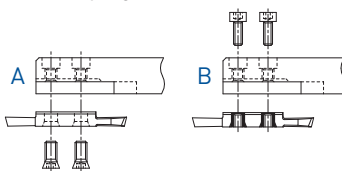

760/750-25
R + L



Chaque support est livré avec vis et clé.
Jeder Halter wird mit Spannschraube(n) und Schlüssel geliefert.
Screw(s) and key are included with each tool holder.

Porte-outils avec arrosage intégré
 Halter mit integrierter Kühlmittelzufuhr
 Holders with integrated coolant supply

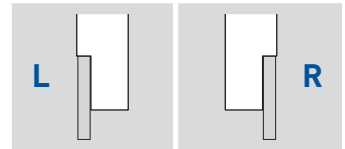
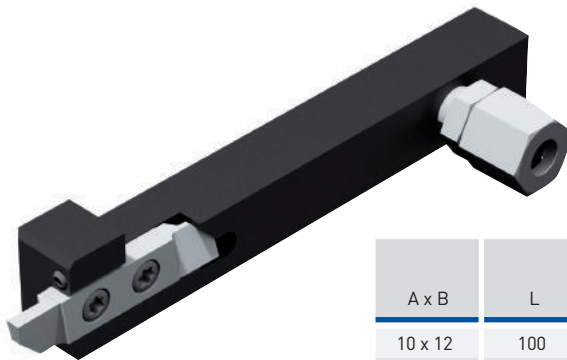
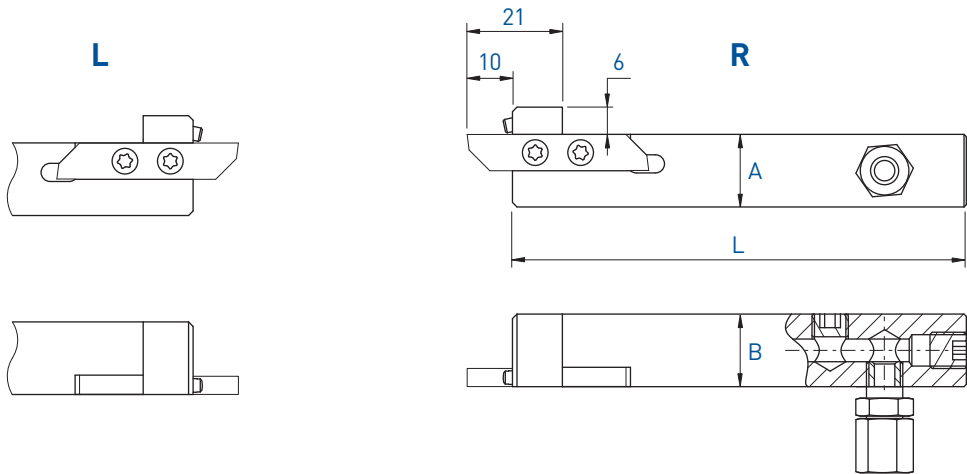

750-JET / 760-JET

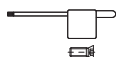

A x B	L	Serrage Spannsystem Clamping	Art. N°	Art. N°
10 x 12	100	A + B	750-1012-JET	760-1012-JET
10 x 12	80	A + B	-	760-1012-80-JET new
12 x 12	100	A + B	750-12-JET	760-12-JET
12.7 x 12.7	100	A + B	750-12.7-JET	760-12.7-JET
16 x 16	100	A + B	750-16-JET	760-16-JET
20 x 20	100	A + B	750-20-JET	760-20-JET

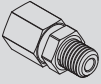

Chaque support est livré avec vis et clé.
 Jeder Halter wird mit Spannschraube(n)
 und Schlüssel geliefert.
 Screw(s) and key are included with each
 tool holder.

Pièces de rechange Ersatzteile Spare parts			Buse Düse Nozzle 
	Art. N°	Art. N°	Art. N°
750-JET / 760-JET	J-M8X1-D6	JB-M8X1	JJ-M3X6-D1.5

Porte-outils

Halter

Holder

Coupe à droite déportée

Versetztes Rechtsschneiden

Right cut off line

750RC

Utiliser des plaquettes type 751R
WSP Typ 751R verwenden
Use inserts type 751R

Voir pages 1.88 - 1.99
Siehe Seiten 1.88 - 1.99
See pages 1.88 - 1.99

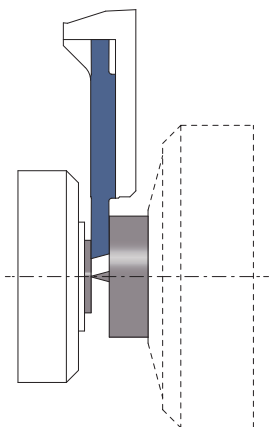
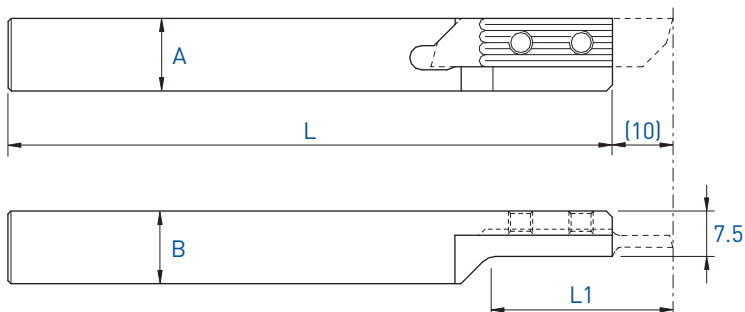

L (R)

Coupe à droite déportée
Versetztes Rechtsschneiden
Right cut off line

A x B	L	L1	Art. N°
12 x 12	130	30	750RC-12
16 x 16	130	40	750RC-16

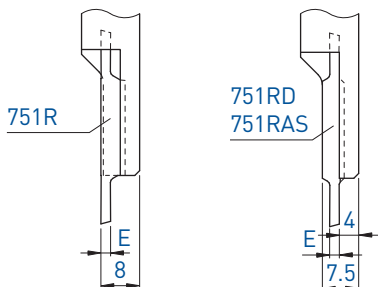

(p. 1.98 - 1.99)

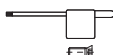

Chaque support est livré avec vis et clé.
Jeder Halter wird mit Spannschraube(n) und Schlüssel geliefert.
Screw(s) and key are included with each tool holder.

Porte-outils

Halter

Holder

Coupe à gauche déportée

Versetztes Linksschneiden

Left cut off line

760LC

Utiliser des plaquettes type 761L
WSP Typ 761L verwenden
Use insets type 761L

Voir pages 1.88 - 1.94 + 1.98
Siehe Seiten 1.88 - 1.94 + 1.98
See pages 1.88 - 1.94 + 1.98

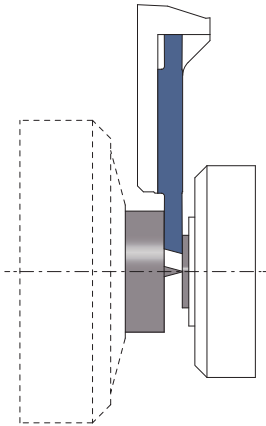
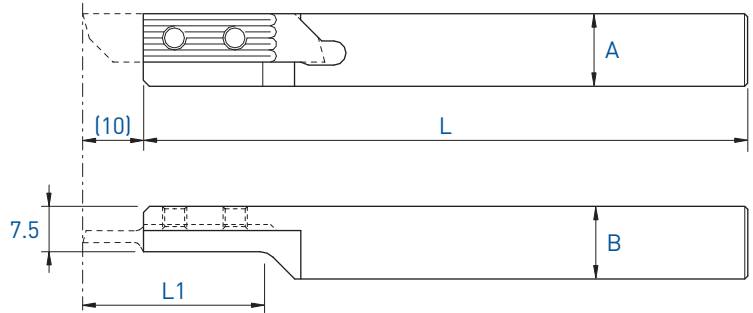

R (L)

Coupe à gauche déportée
Versetztes Linksschneiden
Left cut off line

A x B	L	L1	Art. N°
16 x 16	130	40	760LC-16

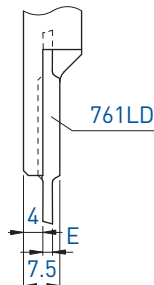
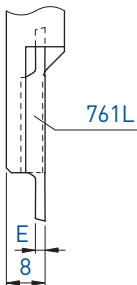

(p. 1.98)



Chaque support est livré avec vis et clé.
Jeder Halter wird mit Spannschraube(n) und Schlüssel geliefert.
Screw(s) and key are included with each tool holder.

R

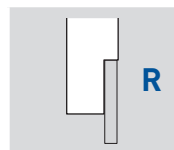
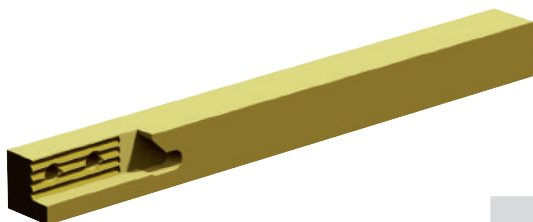
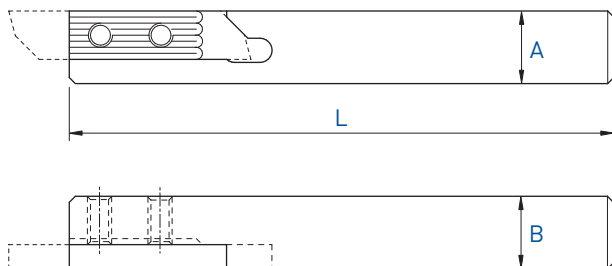

A x B	L	Serrage Spannsystem Clamping	Art. N°
10 x 10	115	A	760-10-NOVIBRA
12 x 12	130	A	760-12-NOVIBRA

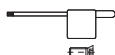

Chaque support est livré avec vis et clé.
 Jeder Halter wird mit Spannschraube(n) und Schlüssel geliefert.
 Screw(s) and key are included with each tool holder.

Porte-outils

Halter

Holders

760 / 750-D10

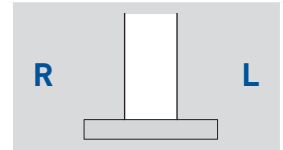
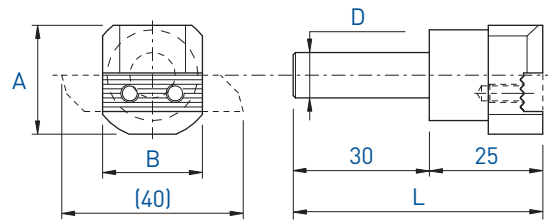

A x B	L	D	Art. N°
24 x 22	55	10	760/750-D10

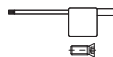

Chaque support est livré avec vis et clé.
 Jeder Halter wird mit Spannschraube(n) und Schlüssel geliefert.
 Screw(s) and key are included with each tool holder.

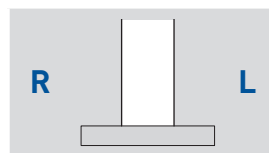
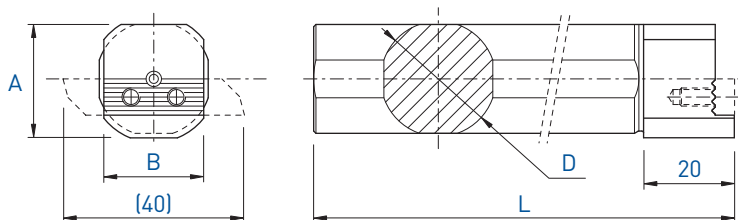

A x B	L	D	Art. N°
25 x 22	160	16	760/750-D16
25 x 22	160	19.05	760/750-D19.05
25 x 22	110	19.05	760/750-D19.05-S
25 x 22	160	20	760/750-D20
25 x 22	110	22	760/750-D22
25 x 22	200	25	760/750-D25
25 x 22	200	25.4	760/750-D25.4
25 x 22	125	25.4	760/750-D25.4-S

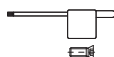

Chaque support est livré avec vis et clé.
 Jeder Halter wird mit Spannschraube(n) und Schlüssel geliefert.
 Screw(s) and key are included with each tool holder.

Porte-outils

Halter

Holders

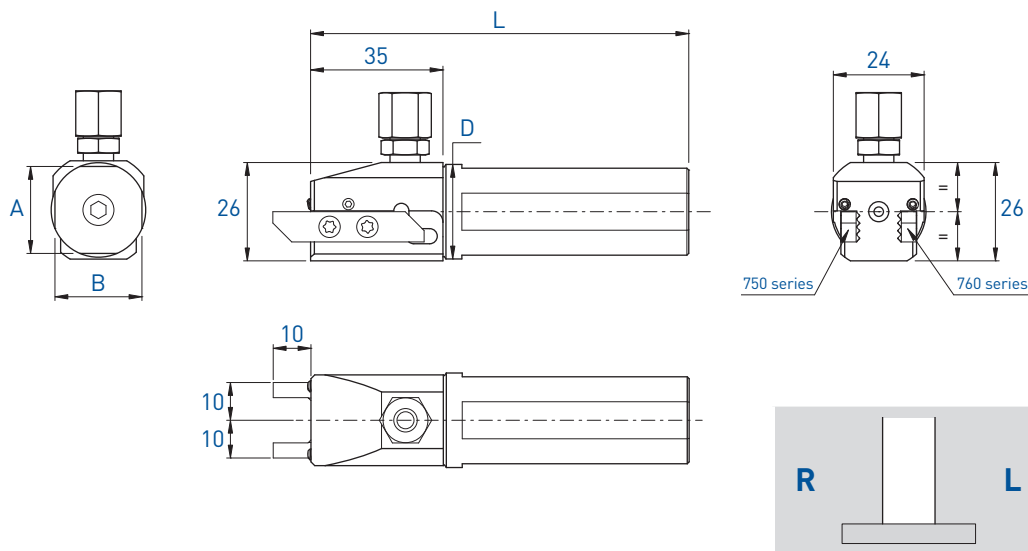

760 / 750-AX

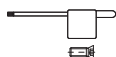

A x B	L	D	Art. N°
23 x 23	100	25	760/750-AX-D25-JET
23 x 23	100	25.4	760/750-AX-D25.4-JET

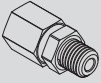

Chaque support est livré avec vis et clé.
 Jeder Halter wird mit Spannschraube(n)
 und Schlüssel geliefert.
 Screw(s) and key are included with each
 tool holder.

Pièces de rechange Ersatzteile Spare parts			Buse Düse Nozzle 
	Art. N°	Art. N°	Art. N°
760/750-AX	J-M8X1-D6	JB-M8X1	JJ-M3X6-D1.5

L

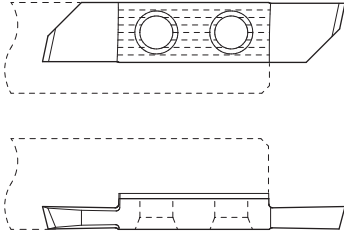

R

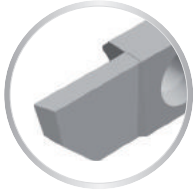
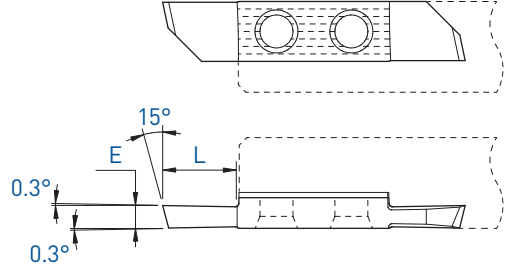

L



R



E	L	Art. N°	TiAlN	TiN	N (µk20)	HTA	HTiN	HN (µk10)	Art. N°	TiAlN	TiAlX	TiN	N (µk20)	HTA	HTiN	HN (µk10)
1.0	5	751-1.0	■	■	■	■	□	■	761-1.0	■	■	■	■	■	■	■
1.2	5	751-1.2	■	■	■				761-1.2	■	■	■	■	■	□	■
1.5	7.5	751-1.5	■	■	■	■	□	■	761-1.5	■	■	■	■	■	■	■
1.8	7.5	751-1.8	■	■	■				761-1.8	■	■	■	■	■	□	■
2.0	10	751-2.0	■	■	■	■	□	■	761-2.0	■	■	■	■	■	■	■
2.2	10	751-2.2	■	■	■				761-2.2	■	■	■	■	■	□	■
2.5	10	751-2.5	■	■	■	■	□	■	761-2.5	■	■	■	■	■	■	■
3.0	10	751-3.0	■	■	■				761-3.0	■	■	■	■	■	□	■

7XX-XX-B



Sur demande pour serrage type B, voir page 1.03
Wahlweise mit B-Spannsystem, siehe Seite 1.03
On request for B clamping system, see page 1.03

Tronçonnage
Abstechen
Parting off

751S / 761S

L

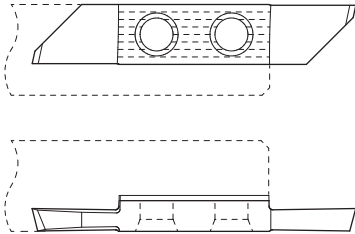

R

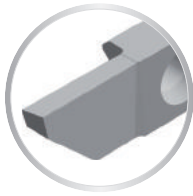
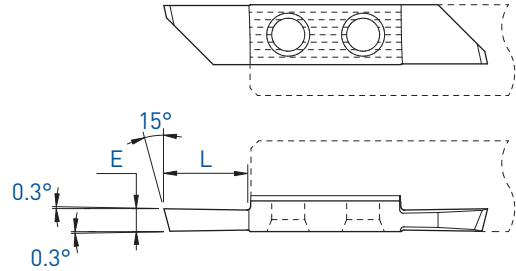

L



R



E	L	Art. N°	TiAlN	TiN	N (µk20)	HTA	HTiN	HN (µk10)	Art. N°	TiAlN	TiAlX	TiN	N (µk20)	HTA	HTiN	HN (µk10)
2.0	11.5	751S-2.0	■	■	■	■	□	■	761S-2.0	■	■	■	■	■	□	■
2.2	11.5	751S-2.2	■	■	■				761S-2.2	■	■	■	■	■	□	■
2.5	11.5	751S-2.5	■	■	■	■	□	■	761S-2.5	■	■	■	■	■	□	■
3.0	11.5	751S-3.0	■	■	■				761S-3.0	■	■	■	■	■	□	■

7XX-XX-B



Sur demande pour serrage type B, voir page 1.03
Wahlweise mit B-Spannsystem, siehe Seite 1.03
On request for B clamping system, see page 1.03

■ = disponible / verfügbar / available
□ = selon disponibilité du stock / jenach Lagerverfügbarkeit / depending on stock availability

Tronçonnage
Abstechen
Parting off

751-R05 / 761-R05

L

R

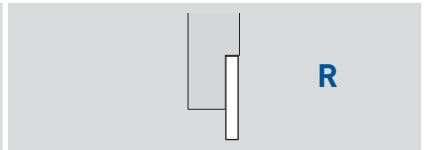
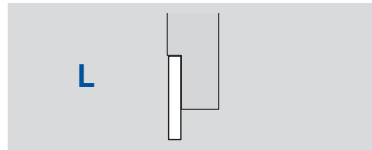
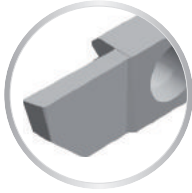
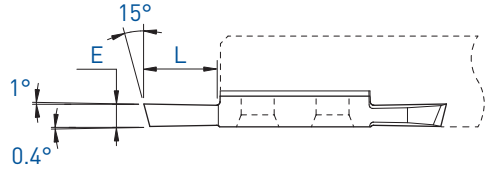
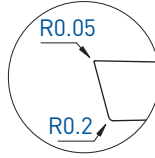
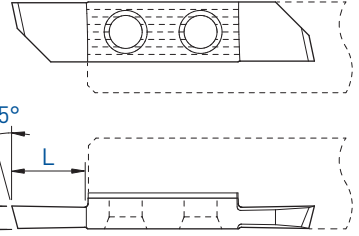
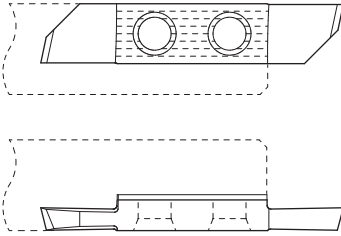

E	L	Art. N°	L			R			HTA	HTiN	HN [µk10]	
			TiAlN	TiN	N [µk20]	TiAlN	TiAlX	TiN				N [µk20]
1.5	7.5	751-1.5-R05	■	■	■					■	□	■
2.0	10	751-2.0-R05	■	■	■					■	□	■
2.5	10	751-2.5-R05	■	■	■					■	□	■

7XX-XX-B

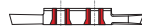

Sur demande pour serrage type B, voir page 1.03
Wahlweise mit B-Spannsystem, siehe Seite 1.03
On request for B clamping system, see page 1.03

Tronçonnage
Abstechen
Parting off

751X4 / 761X4

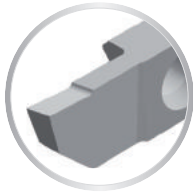
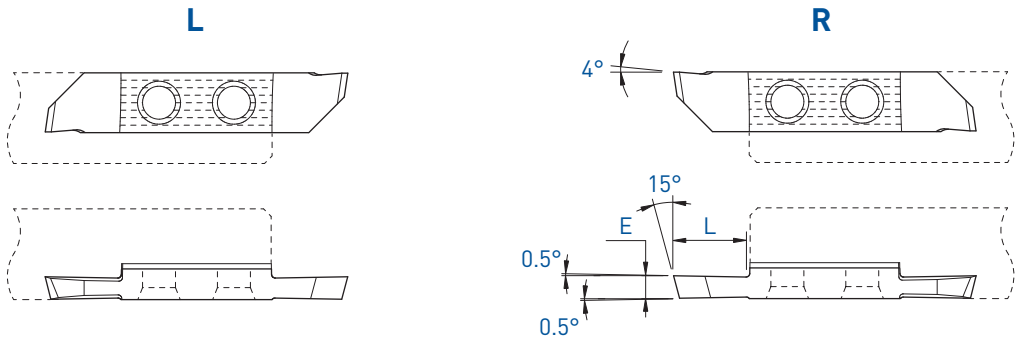

		L						R							
E	L	Art. N°	TiAlN	TiN	N (µk20)	HTA	HTiN	HN (µk10)	Art. N°	TiAlN	TiN	N (µk20)	HTA	HTiN	HN (µk10)
1.5	7.5	-	■	■	■	■	□	■	761X4-1.5	■	■	■	■	□	■
2.0	10	751X4-2.0	■	■	■	■	□	■	761X4-2.0	■	■	■	■	□	■
2.5	10	-	■	■	■	■	■	■	761X4-2.5	■	■	■	■	■	■



7XX-XX-B

Sur demande pour serrage type B, voir page 1.03
Wahlweise mit B-Spannsystem, siehe Seite 1.03
On request for B clamping system, see page 1.03

■ = disponible / verfügbar / available
□ = selon disponibilité du stock / jenach Lagerverfügbarkeit / depending on stock availability

TOP-LINE

- Tronçonnage
- Abstechen
- Parting off

751XF / 761XF

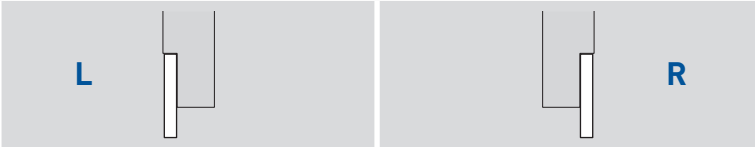
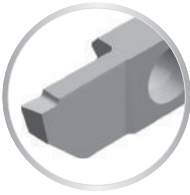
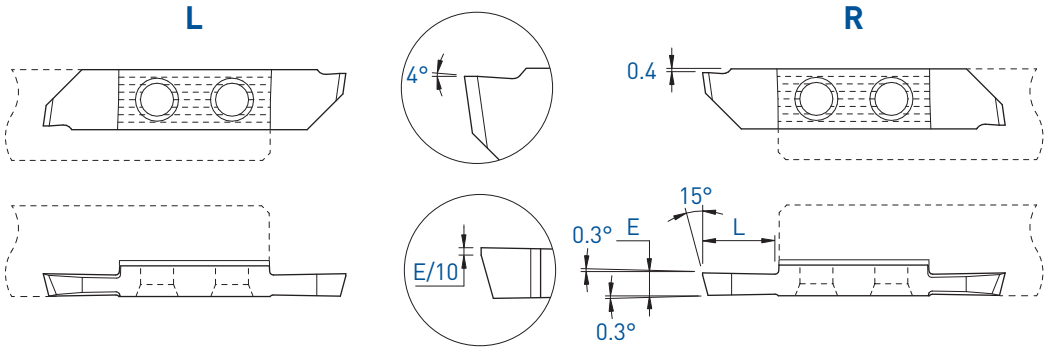

E	L	Art. N°	L			R		
			TiAlN	TiN	N (µk20)	HTA	HTiN	HN (µk10)
1.5	7.5	751XF-1.5	■	■	■	■	□	■
2.0	10	751XF-2.0	■	■	■	■	■	■
2.2	10	751XF-2.2	■	■	■			
2.5	10	751XF-2.5	■	■	■	■	□	■
3.0	10	751XF-3.0	■	■	■			

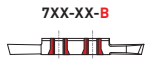

7XX-XX-B
 Sur demande pour serrage type B, voir page 1.03
 Wahlweise mit B-Spannsystem, siehe Seite 1.03
 On request for B clamping system, see page 1.03

Tronçonnage

Abstechen

Parting off

751X12 / 761X12

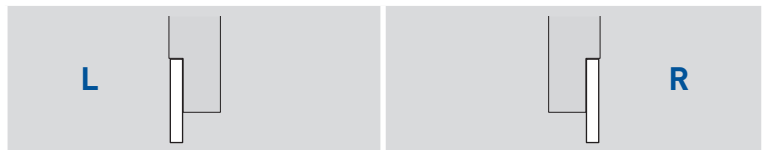
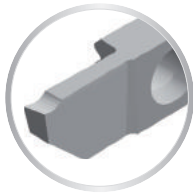
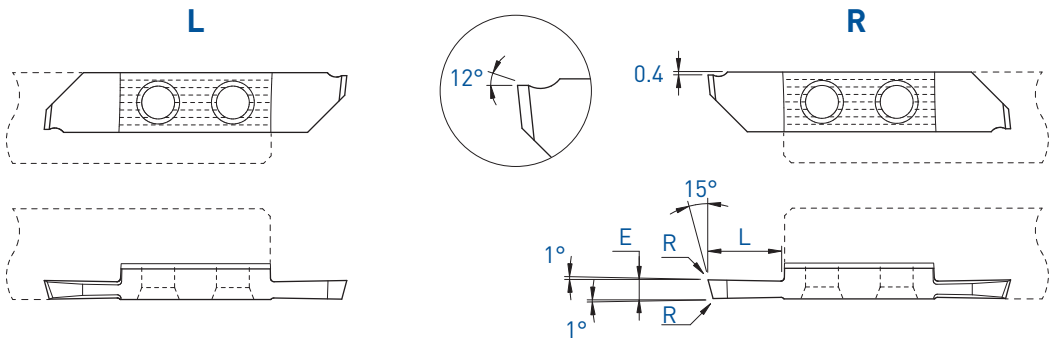

E	L	R	Art. N°	L			R									
				TiAlN	TiN	N (µk20)	HTA	HTiN	HN (µk10)	Art. N°	TiAlN	TiN	N (µk20)	HTA	HTiN	HN (µk10)
1.5	7.5	0.03	751X12-1.5	■	■	■	■	□	■	761X12-1.5	■	■	■	■	□	■
2.0	10	0.03	751X12-2.0	■	■	■	■	□	■	761X12-2.0	■	■	■	■	□	■
2.5	10	0.03	751X12-2.5	■	■	■	■	□	■	761X12-2.5	■	■	■	■	□	■

7XX-XX-B



Sur demande pour serrage type B, voir page 1.03
Wahlweise mit B-Spannsystem, siehe Seite 1.03
On request for B clamping system, see page 1.03

■ = disponible / verfügbar / available
□ = selon disponibilité du stock / jenach Lagerverfügbarkeit / depending on stock availability

Tronçonnage

Abstechen

Parting off

751X25 / 761X25

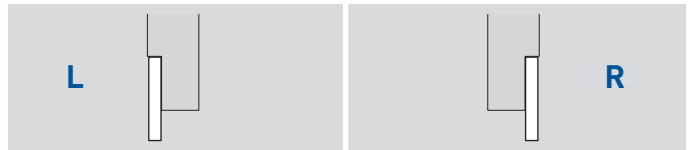
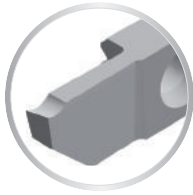
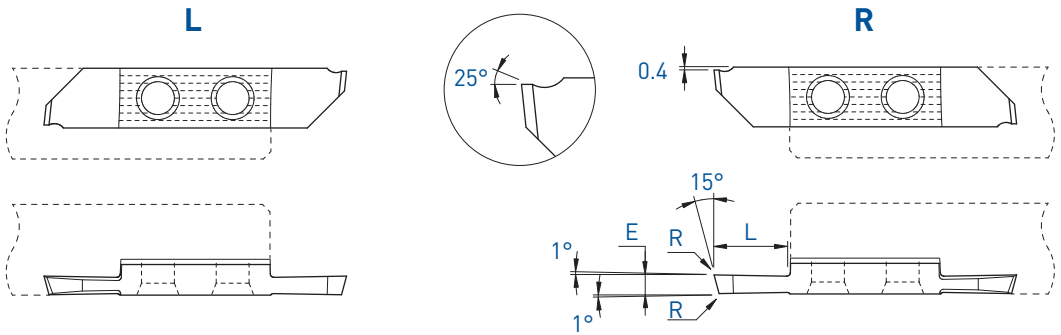

E	L	R	Art. N°	TiAlN	TiN	N (µk20)	HTA	HTiN	HN (µk10)	Art. N°	TiAlN	TiN	N (µk20)	HTA	HTiN	HN (µk10)
1.5	7.5	0.03	751X25-1.5	■	■	■	■	□	■	761X25-1.5	■	■	■			
2.0	10	0.03	751X25-2.0	■	■	■				761X25-2.0	■	■	■	■	□	■
2.5	10	0.03	751X25-2.5	■	■	■				761X25-2.5	■	■	■	■	□	■

7XX-XX-B



Sur demande pour serrage type B, voir page 1.03
Wahlweise mit B-Spannsystem, siehe Seite 1.03
On request for B clamping system, see page 1.03

Tronçonnage
Abstechen
Parting off

751U / 761U

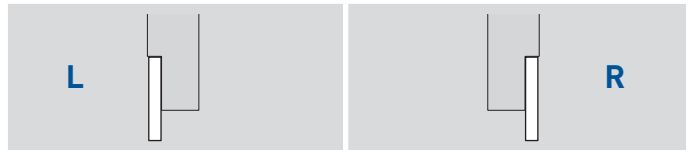
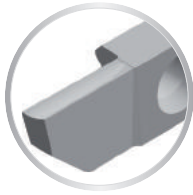
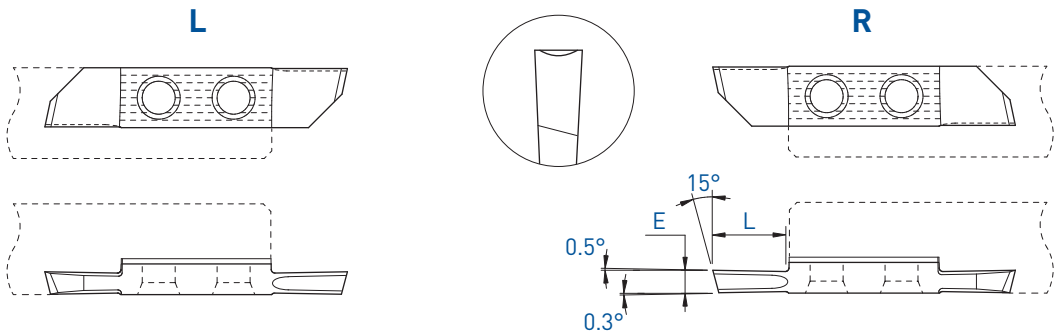

E	L	Art. N°	L			R									
			TiAlN	TiN	N (µk20)	HTA	HTiN	HN (µk10)	Art. N°	TiAlN	TiN	N (µk20)	HTA	HTiN	HN (µk10)
1.5	7.5	-							761U-1.5	■	□	■	■	□	■
2.0	10	751U-2.0	■	■	■				761U-2.0	■	■	■	□	□	■

7XX-XX-B



Sur demande pour serrage type B, voir page 1.03
Wahlweise mit B-Spannsystem, siehe Seite 1.03
On request for B clamping system, see page 1.03

■ = disponible / verfügbar / available
□ = selon disponibilité du stock / jenach Lagerverfügbarkeit / depending on stock availability

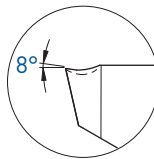

0.2

R

A
L
4°
4°

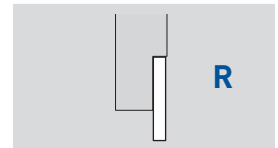
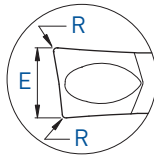

E	A	L	R	Art. N°	TiAlN N (µm20)
2.0	0°	11	0.10	761ZU8-2.0-R10	■
2.0	8°	11	0.10	761ZU8-2.0-8°-R10	■



Arête de coupe honée
Gehonte Schneidkante
Honed edge

f min: 0.02 mm/U

7XX-XX-B



Sur demande pour serrage type B, voir page 1.03
Wahlweise mit B-Spannsystem, siehe Seite 1.03
On request for B clamping system, see page 1.03

Tronçonnage
Abstechen
Parting off

751NXF / 761NXF

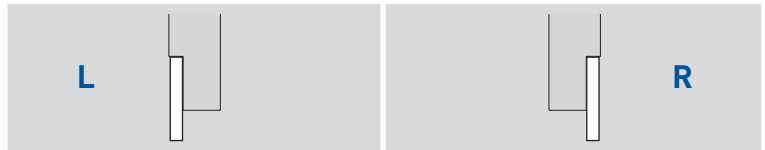
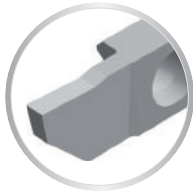
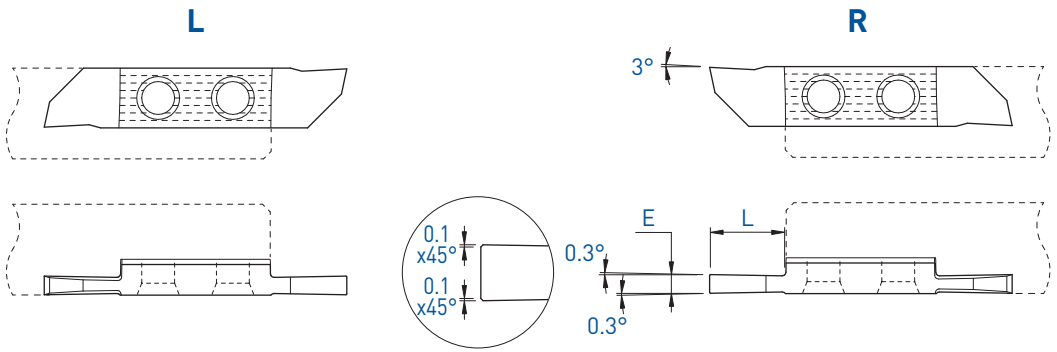

E	L	Art. N°	L			R		
			TiAlN	TiN	N (µk20)	HTA	HTiN	HN (µk10)
2.0	10	751NXF-2.0	■	■	■	■	□	■
2.5	10	751NXF-2.5	■	■	■			
3.0	10	751NXF-3.0	■	■	■			

7XX-XX-B

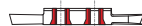

Sur demande pour serrage type B, voir page 1.03
Wahlweise mit B-Spannsystem, siehe Seite 1.03
On request for B clamping system, see page 1.03

■ = disponible / verfügbar / available
□ = selon disponibilité du stock / jenach Lagerverfügbarkeit / depending on stock availability

Tronçonnage

Abstechen

Parting off

Coupe déportée

Versetztes Schneiden

Cut off line

761L / 751R

Cut L

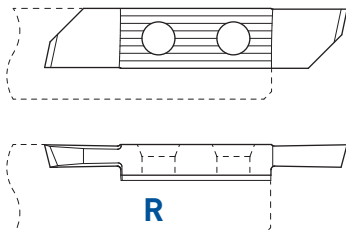

Cut R

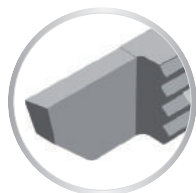
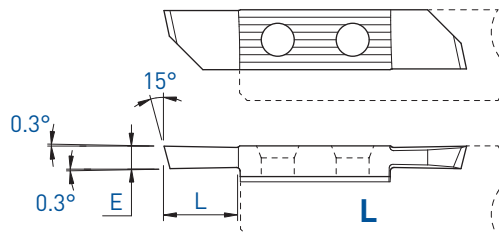

R (L)

Coupe à gauche déportée
Versetztes Linksschneiden
Left cut off line

L (R)

Coupe à droite déportée
Versetztes Rechtsschneiden
Right cut off line

E	L	Art. N°	TiAlN	TiN	N (µk20)	HTA	HTiN	HN (µk10)	Art. N°	TiAlN	TiAlX	TiN	N (µk20)	HTA	HTiN	HN (µk10)
1.0	5	761L-1.0	■	■	■	■	□	■	751R-1.0	■	■	■	■	■	□	■
1.5	7.5	761L-1.5	■	■	■	■	□	■	751R-1.5	■	■	■	■	■	□	■
1.8	7.5	761L-1.8	■	■	■				751R-1.8	■	■	■	■	■	□	■
2.0	10	761L-2.0	■	■	■	■	□	■	751R-2.0	■	■	■	■	■	■	■
2.2	10	761L-2.2	■	■	■				751R-2.2	■	■	■	■			
2.5	10	761L-2.5	■	■	■	■	□	■	751R-2.5	■	■	■	■	■	■	■
3.0	10	761L-3.0	■	■	■				751R-3.0	■	■	■	■	■	□	■

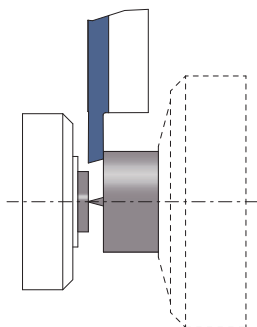

Tronçonnage
Abstechen
Parting off

Coupe déportée
Versetztes Schneiden
Cut off line

761LS / 751RS

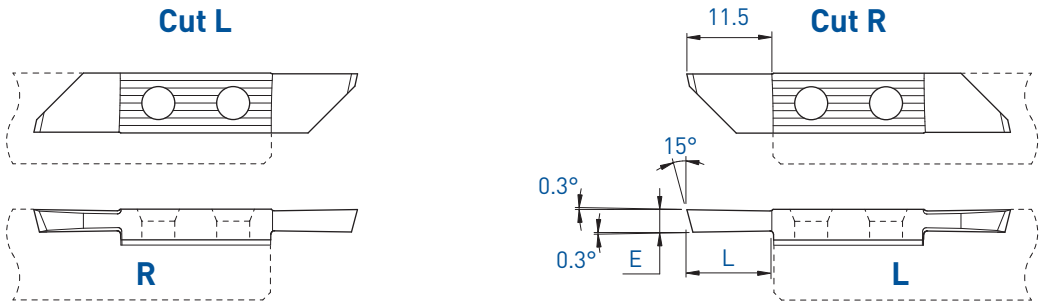

R (L)	L (R)
Coupe à gauche déportée Versetztes Linksschneiden Left cut off line	Coupe à droite déportée Versetztes Rechtsschneiden Right cut off line

E	L	Art. N°	TiAlN	TiN	N (µk20)	HTA	HTiN	HN (µk10)	Art. N°	TiAlN	TiAlX	TiN	N (µk20)	HTA	HTiN	HN (µk10)
1.0	5.5	761LS-1.0	■	■	■	■	□	■	751RS-1.0	■	■	■	■	■	□	■
1.5	8	761LS-1.5	■	■	■	■	□	■	751RS-1.5	■	■	■	■	■	□	■
2.0	11.5	761LS-2.0	■	■	■				751RS-2.0	■	■	■	■	■	■	■
2.2	11.5	761LS-2.2	■	■	■				751RS-2.2	■	■	■	■	■	□	■
2.5	11.5	761LS-2.5	■	■	■				751RS-2.5	■	■	■	■	■	□	■
3.0	11.5	761LS-3.0	■	■	■				751RS-3.0	■	■	■	■	■	□	■

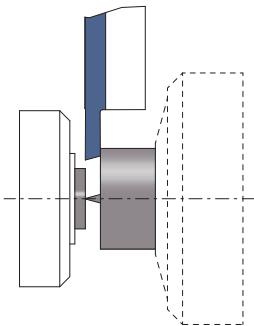

TOP-LINE

Tronçonnage
Abstechen
Parting off

Coupe déportée
Versetztes Schneiden
Cut off line

761L-R05 / 751R-R05

Cut L

Cut R

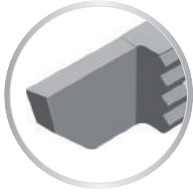
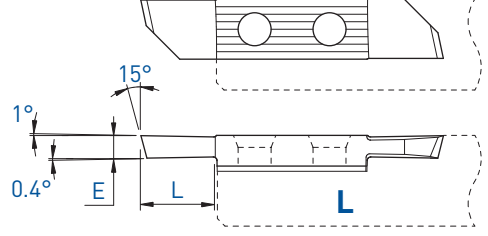
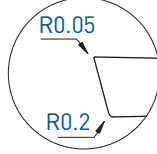
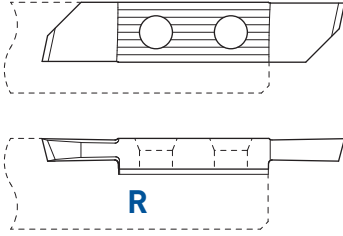

R (L)

Coupe à gauche déportée
Versetztes Linksschneiden
Left cut off line

L (R)

Coupe à droite déportée
Versetztes Rechtsschneiden
Right cut off line

E	L	Art. N°	TiAlN	TiN	N (µk20)	HTA	HTiN	HN (µk10)	Art. N°	TiAlN	TiAlX	TiN	N (µk20)	HTA	HTiN	HN (µk10)
1.5	7.5	761L-1.5-R05	■	■	■				751R-1.5-R05	■	■	■	■	■	□	■
2.0	10	761L-2.0-R05	■	■	■				751R-2.0-R05	■	■	■	■			

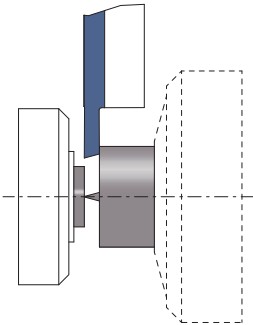

Tronçonnage
Abstechen
Parting off

Coupe déportée
Versetztes Schneiden
Cut off line

761LX4 / 751RX4

Cut L

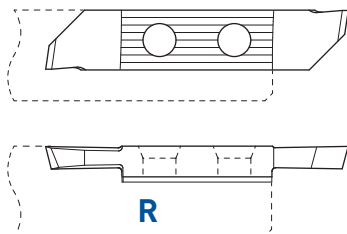

Cut R

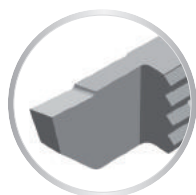
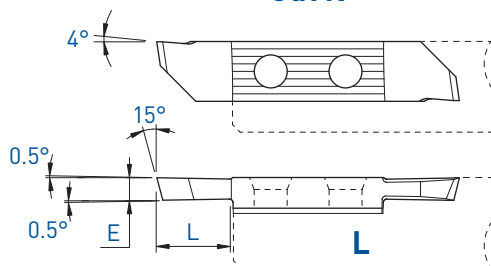

R (L)

Coupe à gauche déportée
Versetztes Linksschneiden
Left cut off line

L (R)

Coupe à droite déportée
Versetztes Rechtsschneiden
Right cut off line

E	L	Art. N°	TiAlN	TiN	N [µk20]	HTA	HTiN	HN [µk10]	Art. N°	TiAlN	TiN	N [µk20]	HTA	HTiN	HN [µk10]
1.5	7.5	-							751RX4-1.5	■	■	■	■	■	■
2.0	10	761LX4-2.0	■	■	■				751RX4-2.0	■	■	■	■	■	■
2.5	10	-							751RX4-2.5	■	■	■			

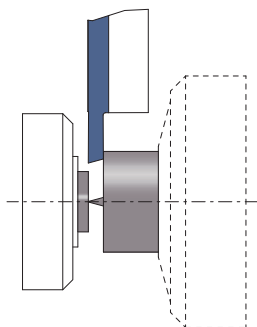

Tronçonnage
Abstechen
Parting off

Coupe déportée
Versetztes Schneiden
Cut off line

761LXF / 751RXF

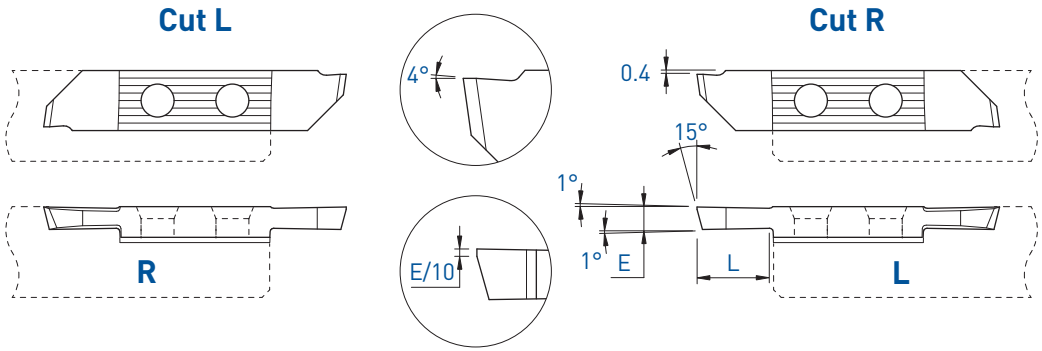

R (L)						L (R)					
Coupe à gauche déportée Versetztes Linksschneiden Left cut off line						Coupe à droite déportée Versetztes Rechtsschneiden Right cut off line					

E	L	Art. N°	TiAlN	TiN	N (µk20)	HTA	HTiN	HN (µk10)	Art. N°	TiAlN	TiN	N (µk20)	HTA	HTiN	HN (µk10)
1.5	7.5	-	■	■	■				751RXF-1.5	■	■	■	■	□	■
2.0	10	761LXF-2.0	■	■	■				751RXF-2.0	■	■	■	■	■	■
2.5	10	761LXF-2.5	■	■	■				751RXF-2.5	■	■	■	■	□	■
3.0	10	761LXF-3.0	■	■	■				751RXF-3.0	■	■	■	■	□	■

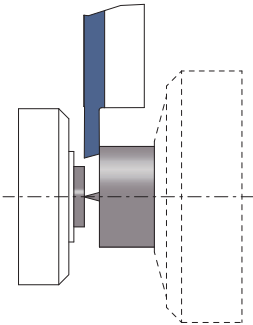

Tronçonnage
Abstechen
Parting off

Coupe déportée
Versetztes Schneiden
Cut off line

761LX12 / 751RX12

Cut L

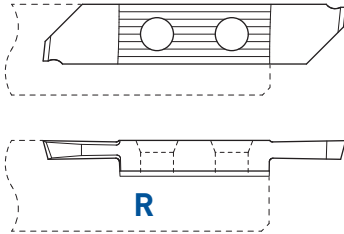

Cut R

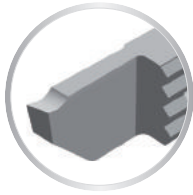
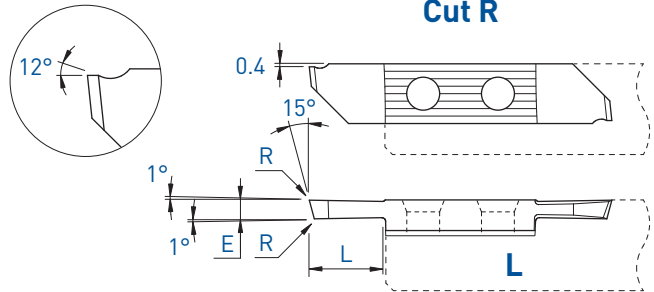

R (L)

Coupe à gauche déportée
Versetztes Linksschneiden
Left cut off line

L (R)

Coupe à droite déportée
Versetztes Rechtsschneiden
Right cut off line

E	L	R	Art. N°	TiAlN	TiN	N [µk20]	HTA	HTiN	HN [µk10]	Art. N°	TiAlN	TiN	N [µk20]	HTA	HTiN	HN [µk10]
1.5	7.5	0.03	-							751RX12-1.5	■	■	■			
2.0	10	0.03	761LX12-2.0	■	■	■				751RX12-2.0	■	■	■	■	■	■

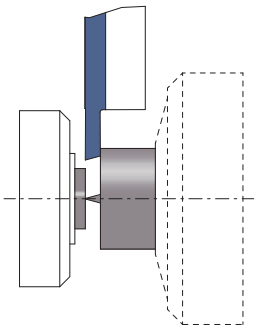

TOP-LINE

Tronçonnage
Abstechen
Parting off

Coupe déportée
Versetztes Schneiden
Cut off line

761LX25 / 751RX25

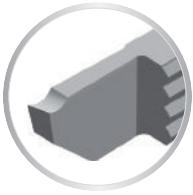
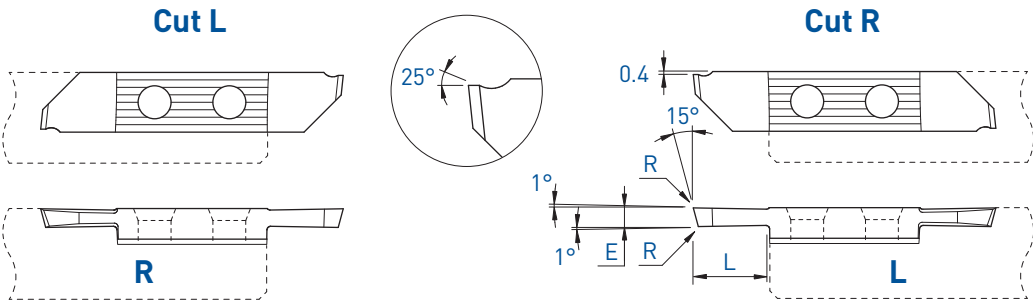

R (L)	L (R)
Coupe à gauche déportée Versetztes Linksschneiden Left cut off line	Coupe à droite déportée Versetztes Rechtsschneiden Right cut off line

E	L	R	Art. N°	TiAIN	TiN	N (µk20)	Art. N°	TiAIN	TiN	N (µk20)
2.0	10	0.03	761LX25-2.0	■	■	■	751RX25-2.0	■	■	■

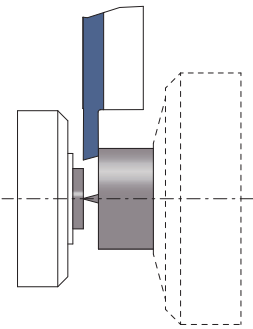

Tronçonnage
Abstechen
Parting off

Coupe déportée
Versetztes Schneiden
Cut off line

751RU

Cut R

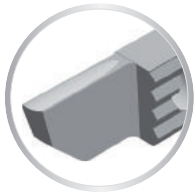
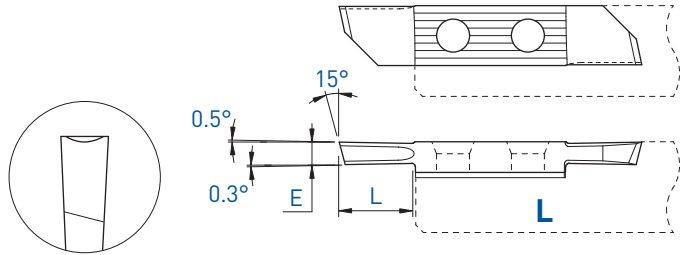

L (R)

Coupe à droite déportée
Versetztes Rechtsschneiden
Right cut off line

E	L	Art. N°	TiAIN	TiN	N (µk20)
1.5	7.5	751RU-1.5	■	■	■
2.0	10	751RU-2.0	■	■	■

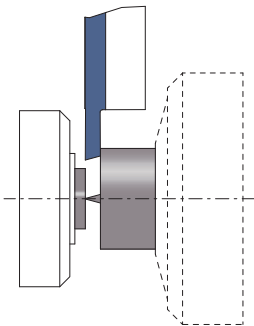

Tronçonnage
Abstechen
Parting off

Coupe déportée
Versetztes Schneiden
Cut off line

751RZU

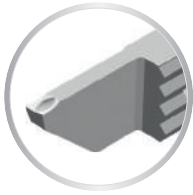
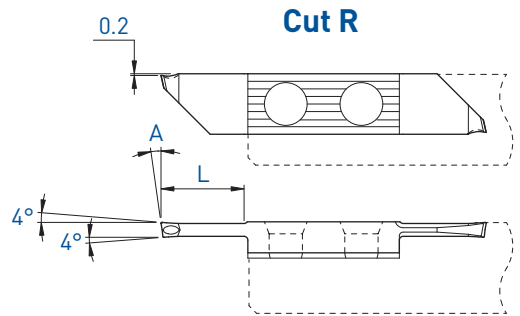
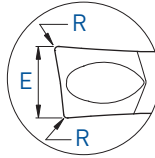
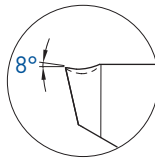

R (L)

Coupe à gauche déportée
Versetztes Linksschneiden
Left cut off line

E	A	L	R	Art. N°	TiAlN	TiN	N (µk20)
2.0	8°	11.0	0.10	751RZU8-2.0-8°-R10	■		

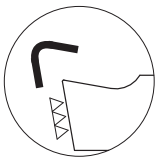

Arête de coupe honée
Gehonte Schneidkante
Honed edge

f min: 0.02 mm/U

Tronçonnage
Abstechen
Parting off

Coupe déportée
Versetztes Schneiden
Cut off line

761NXF / 751NXF

Cut L

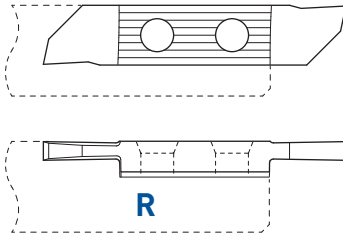

Cut R

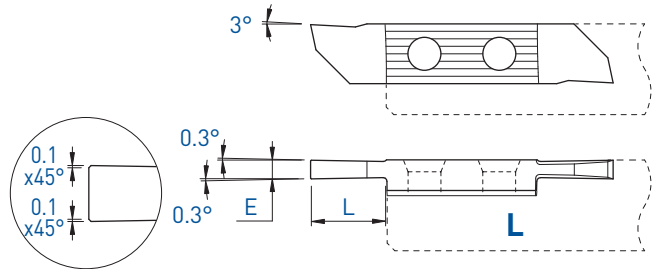

R (L)

Coupe à gauche déportée
Versetztes Linksschneiden
Left cut off line

L (R)

Coupe à droite déportée
Versetztes Rechtsschneiden
Right cut off line

E	L	Art. N°	TiAlN	TiN	N (µk20)	HTA	HTiN	HN (µk10)	Art. N°	TiAlN	TiN	N (µk20)	HTA	HTiN	HN (µk10)
2.0	10	761NXF-2.0	■	■	■	■	□	■	751NXF-2.0	■	■	■	■	□	■
2.5	10	761NXF-2.5	■	■	■				751NXF-2.5	■	■	■			
3.0	10	761NXF-3.0	■	■	■				751NXF-3.0	■	■	■			

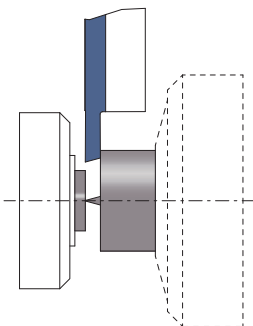

Tronçonnage
Abstechen
Parting off

Coupe déportée
Versetztes Schneiden
Cut off line

761LD / 751RD

Cut L

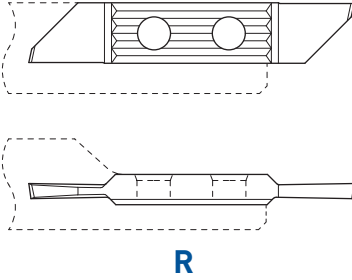

Cut R

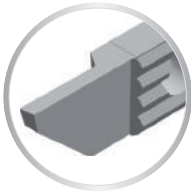
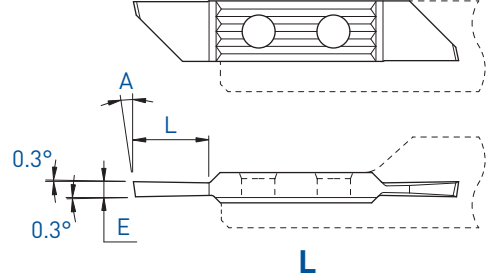

R (L)

Coupe à gauche déportée
Versetztes Linksschneiden
Left cut off line

L (R)

Coupe à droite déportée
Versetztes Rechtsschneiden
Right cut off line

E	A	L	Art. N°	Coatings			Performance			Art. N°	Coatings			Performance		
				TiAlN	TiN	N (µk20)	HTA	HTiN	HN (µk10)		TiAlN	TiN	N (µk20)	HTA	HTiN	HN (µk10)
1.0	8°	5	761LD-1.0-8°	■	■	■	■	□	■	751RD-1.0-8°	■	■	■	■	□	■
1.0	15°	5	761LD-1.0-15°	■	■	■	■	□	■	751RD-1.0-15°	■	■	■	■	□	■
1.2	8°	5	761LD-1.2-8°	■	■	■				751RD-1.2-8°	■	■	■	■	□	■
1.5	8°	8	761LD-1.5-8°	■	■	■				751RD-1.5-8°	■	■	■	■	■	■
1.5	15°	8	761LD-1.5-15°	■	■	■				751RD-1.5-15°	■	■	■	■	□	■
1.6	8°	8	761LD-1.6-8°	■	■	■				751RD-1.6-8°	■	■	■			
1.8	8°	10	761LD-1.8-8°	■	■	■				751RD-1.8-8°	■	■	■	■	□	■
2.0	8°	10	761LD-2.0-8°	■	■	■				751RD-2.0-8°	■	■	■	■	□	■
2.0	15°	10	761LD-2.0-15°	■	■	■	■	□	■	751RD-2.0-15°	■	■	■	■	□	■
2.5	8°	10	-							751RD-2.5-8°	■	■	■	■	□	■

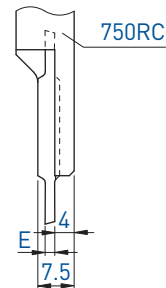
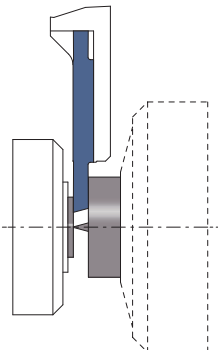

Tronçonnage
Abstechen
Parting off

Coupe déportée
Versetztes Schneiden
Cut off line

751RAS

Cut R

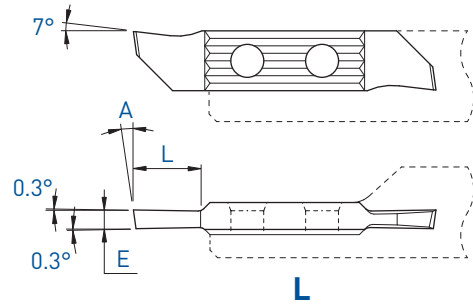

L (R)

Coupe à droite déportée
Versetztes Rechtsschneiden
Right cut off line

E	A	L	Art. N°	TiAlN	TiN	N (µk20)	HTA	HTiN	HN (µk10)
1.6	8°	7.5	751RAS-1.6-8°	■	■	■			
1.6	15°	7.5	751RAS-1.6-15°	■	■	■	■	□	■
2.0	8°	9	751RAS-2.0-8°	■	■	■	■	□	■
2.0	15°	9	751RAS-2.0-15°	■	■	■			
2.5	8°	9	751RAS-2.5-8°	■	■	■			
2.5	15°	9	751RAS-2.5-15°	■	■	■			

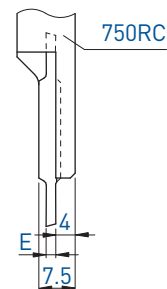
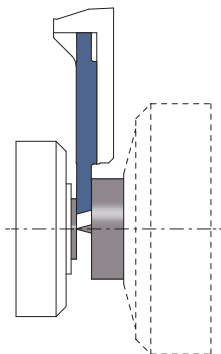

TOP-LINE

Tournage avant
Vorwärts drehen
Front turning

752 / 762

L

R

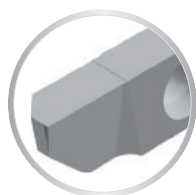
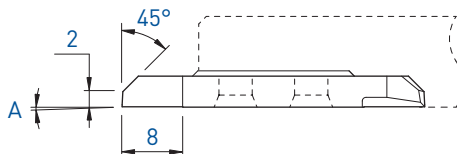
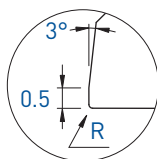
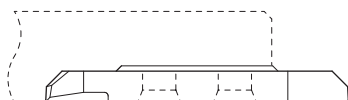
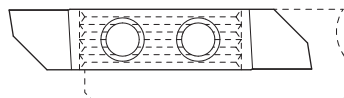
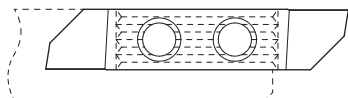

L

R

A	R	Art. N°	TiAlN	TiN	N (µk20)	HTA	HTiN	HN (µk10)	Art. N°	TiAlN	TiN	N (µk20)	HTA	HTiN	HN (µk10)
0°	0	752	■	■	■	■	□	■	762	■	■	■	■	□	■
0°	0.20	-							762-R20	■	■	■	■	□	■
3°	0	752-3°	■	■	■	■	□	■	762-3°	■	■	■	■	□	■

7XX-XX-B



Sur demande pour serrage type B, voir page 1.03
Wahlweise mit B-Spannsystem, siehe Seite 1.03
On request for B clamping system, see page 1.03

Tournage avant
Vorwärts drehen
Front turning

752PX / 762PX

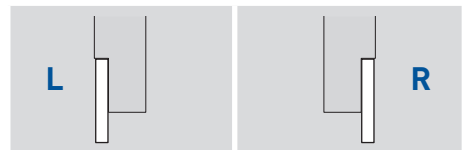
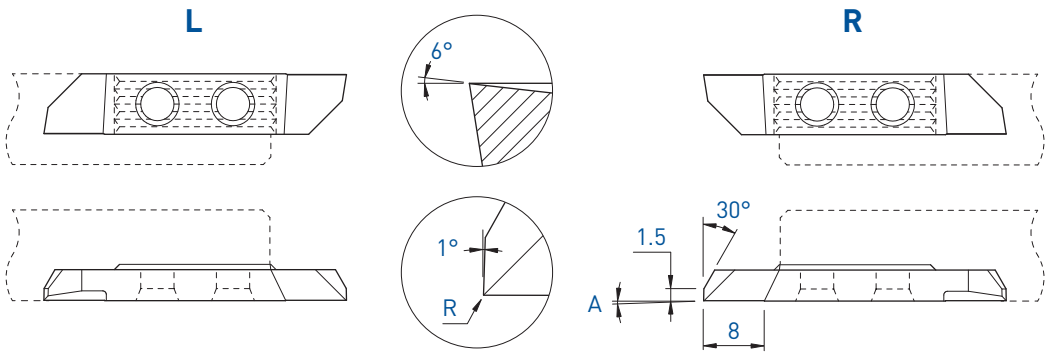

A	R	Art. N°	TiAlN	TiN	N [µk20]	Art. N°	TiAlN	TiN	N [µk20]
0°	0	752PX	■	■	■	762PX	■	■	■

7XX-XX-B



Sur demande pour serrage type B, voir page 1.03
Wahlweise mit B-Spannsystem, siehe Seite 1.03
On request for B clamping system, see page 1.03

■ = disponible / verfügbar / available
□ = selon disponibilité du stock / jenach Lagerverfügbarkeit / depending on stock availability

TOP-LINE

Tournage avant
Vorwärts drehen
Front turning

752X / 762X

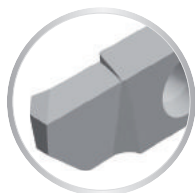
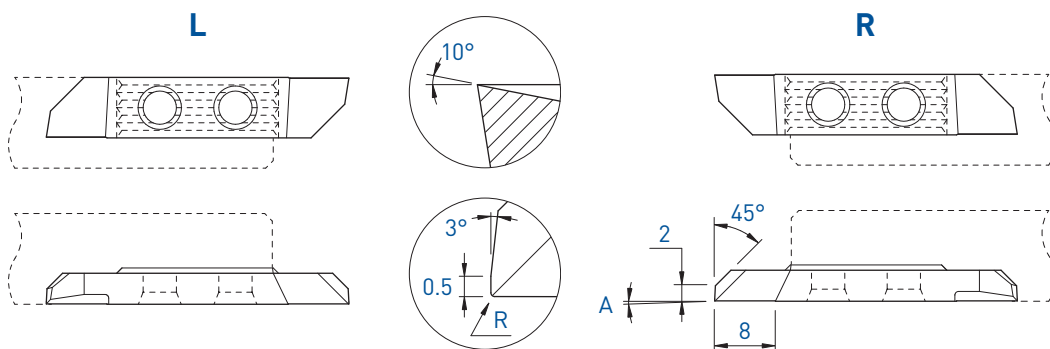

A	R	Art. N°	TiAlN	TiN	N (µk20)	HTA	HTiN	HN (µk10)	Art. N°	TiAlN	TiN	N (µk20)	HTA	HTiN	HN (µk10)
0°	0	752X	■	■	■	■	■	■	762X	■	■	■	■	■	■
0°	0.20	752X-R20	■	■	■				762X-R20	■	■	■			

7XX-XX-B



Sur demande pour serrage type B, voir page 1.03
Wahlweise mit B-Spannsystem, siehe Seite 1.03
On request for B clamping system, see page 1.03

Tournage avant
Vorwärts drehen
Front turning

762VX-800

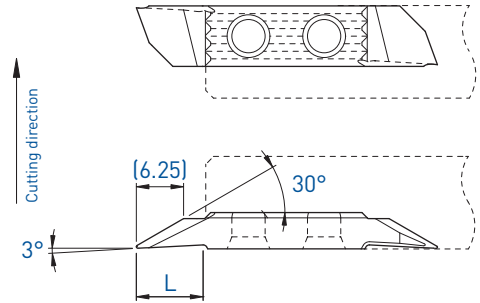
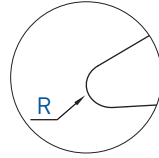
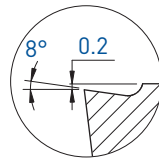

L	R	Art. N°	HTA	HTiN	HN [µk10]
9	0.15	762VX-800-R15	■	■	■

Tournage avant
Vorwärts drehen
Front turning

762VUX

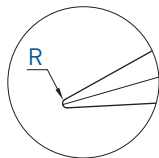
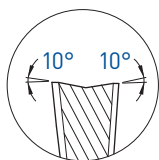

R

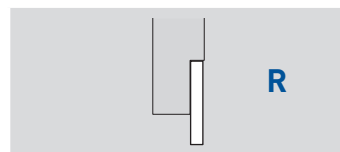
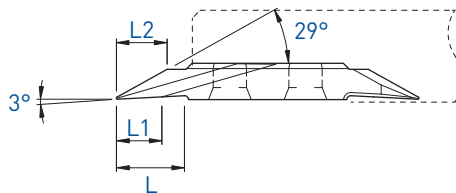
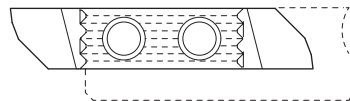

L	L1	L2	R	Art. N°	TiAlN N [µk20]	HTA	HN [µk10]
9	6	6.9	0.08	762VUX10-29°-R08	■ ■	■ ■	
9	6	6.7	0.15	762VUX10-29°-R15	■ ■	■ ■	
9	6	6.1	0.35	762VUX10-29°-R35	■ ■	■ ■	
9	6	4.9	0.75	762VUX10-29°-R75	■ ■	■ ■	

Tournage avant
Vorwärts drehen
Front turning

762ZX

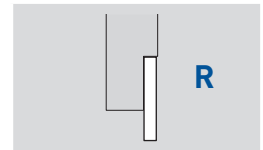
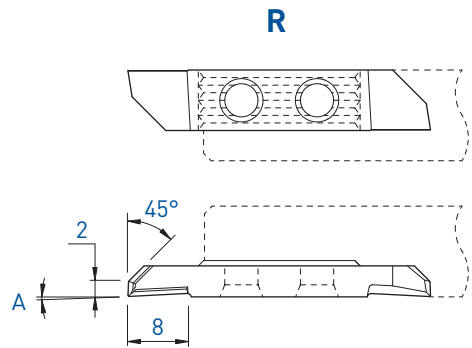
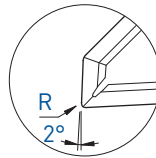
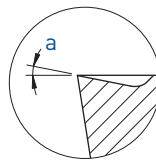

a	A	R	Art. N°	TiAIN	TiN	N (µk20)
10°	3°	0.08	762ZX10-R08	■	□	
	3°	0.20	762ZX10-R20	■	□	



Arête de coupe honée
Gehonte Schneidkante
Honed edge

f min: 0.02 mm/U

7XX-XX-B

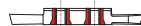

Sur demande pour serrage type B, voir page 1.03
Wahlweise mit B-Spannsystem, siehe Seite 1.03
On request for B clamping system, see page 1.03

■ = disponible / verfügbar / available
□ = selon disponibilité du stock / jenach Lagerverfügbarkeit / depending on stock availability

TOP-LINE

Tournage multifonction
 Mehrzweck Drehen
 Multifunction turning

752S / 762S
 753S / 763S

L

R

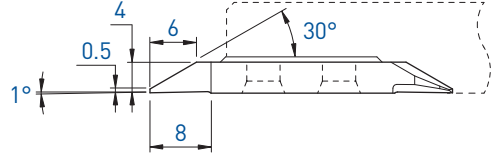
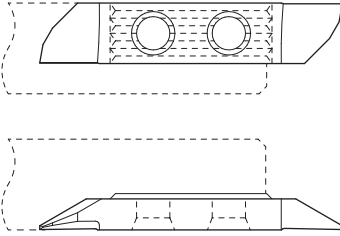

Tournage avant
 Vorwärts drehen
 Front turning

L						R								
Art. N°	TiAlN	TiN	N (µk20)	HTA	HTiN	HN (µk10)	Art. N°	TiAlN	TiAlX	TiN	N (µk20)	HTA	HTiN	HN (µk10)
752S05	■	■	■	■	□	■	762S05	■	■	■	■	■	■	■

L

R

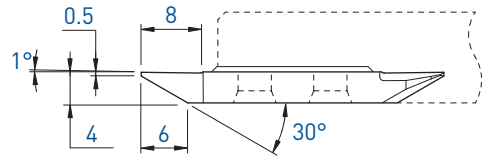
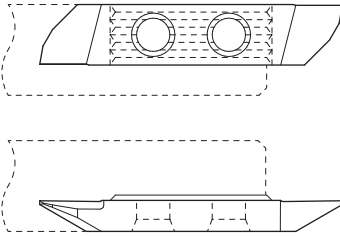

Tournage arrière
 Rückwärts drehen
 Back turning

L						R								
Art. N°	TiAlN	TiN	N (µk20)	HTA	HTiN	HN (µk10)	Art. N°	TiAlN	TiAlX	TiN	N (µk20)	HTA	HTiN	HN (µk10)
753S05	■	■	■	■	■	■	763S05	■	■	■	■	■	■	■

Tournage arrière
Rückwärts drehen
Back turning

753 / 763

L

R

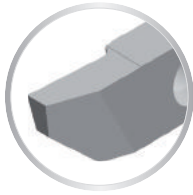
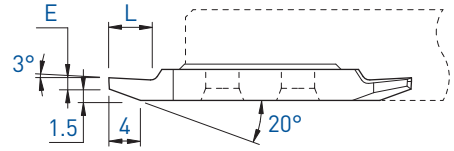
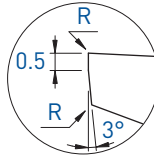
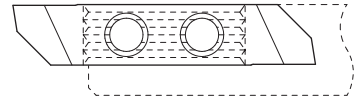
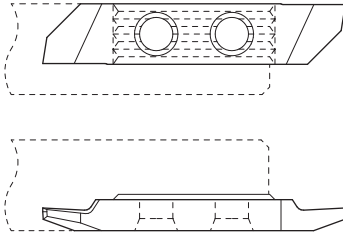

L

R

E	L	R	Art. N°	TiAlN	TiN	N (µk20)	HTA	HTiN	HN (µk10)	Art. N°	TiAlN	TiN	N (µk20)	HTA	HTiN	HN (µk10)
1.0	5	0	753-1.0	■	■	■	■	□	■	763-1.0	■	■	■	■	■	■
1.0	5	0.08	753-1.0-R08	■	■	■				763-1.0-R08	■	■	■	■	□	■
1.5	6	0	753-1.5	■	■	■				763-1.5	■	■	■	■	□	■
2.0	7.5	0	753-2.0	■	■	■				763-2.0	■	■	■	■	□	■
2.5	9	0	753-2.5	■	■	■				763-2.5	■	■	■	■	□	■

7XX-XX-B

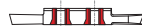

Sur demande pour serrage type B, voir page 1.03
Wahlweise mit B-Spannsystem, siehe Seite 1.03
On request for B clamping system, see page 1.03

■ = disponible / verfügbar / available
□ = selon disponibilité du stock / jenach Lagerverfügbarkeit / depending on stock availability

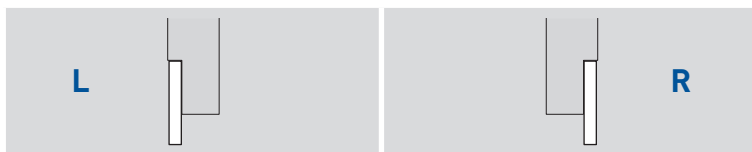
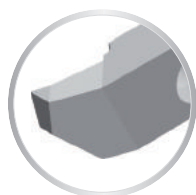
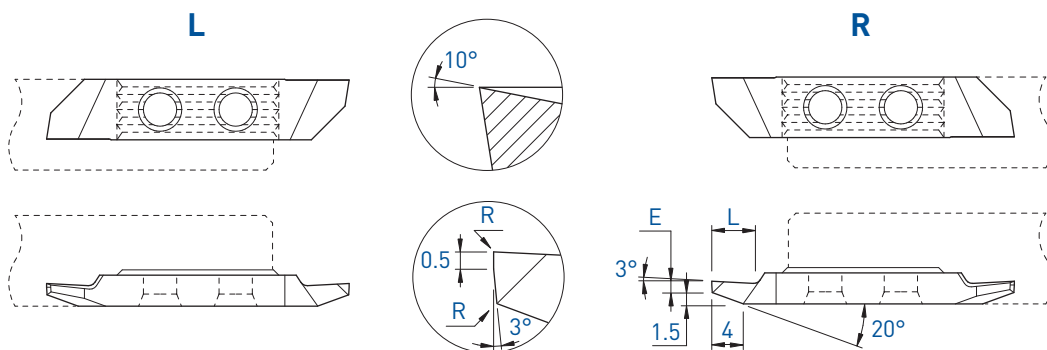

			L				R									
E	L	R	Art. N°	TiAlN	TiN	N (µk20)	HTA	HTiN	HN (µk10)	Art. N°	TiAlN	TiN	N (µk20)	HTA	HTiN	HN (µk10)
1.0	5	0	753X-1.0	■	■	■				763X-1.0	■	■	■	■	□	■
1.0	5	0.08	753X-1.0-R08	■	■	■	■	□	■	763X-1.0-R08	■	■	■	■	□	■
1.0	5	0.20	753X-1.0-R20	■	■	■				763X-1.0-R20	■	■	■			
1.5	6	0	753X-1.5	■	■	■				763X-1.5	■	■	■	■	□	■
1.5	6	0.20	753X-1.5-R20	■	■	■				763X-1.5-R20	■	■	■			
2.0	7.5	0	753X-2.0	■	■	■				763X-2.0	■	■	■			
2.0	7.5	0.20	753X-2.0-R20	■	■	■				763X-2.0-R20	■	■	■			
2.5	9	0	753X-2.5	■	■	■				763X-2.5	■	■	■			
2.5	9	0.20	753X-2.5-R20	■	■	■				763X-2.5-R20	■	■	■			

7XX-XX-B



Sur demande pour serrage type B, voir page 1.03
Wahlweise mit B-Spannsystem, siehe Seite 1.03
On request for B clamping system, see page 1.03

Tournage arrière
Rückwärts drehen
Back turning

753XS / 763XS

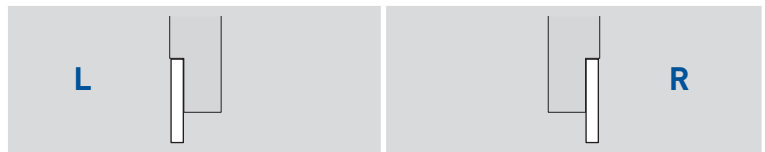
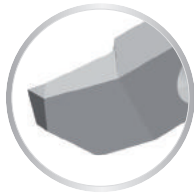
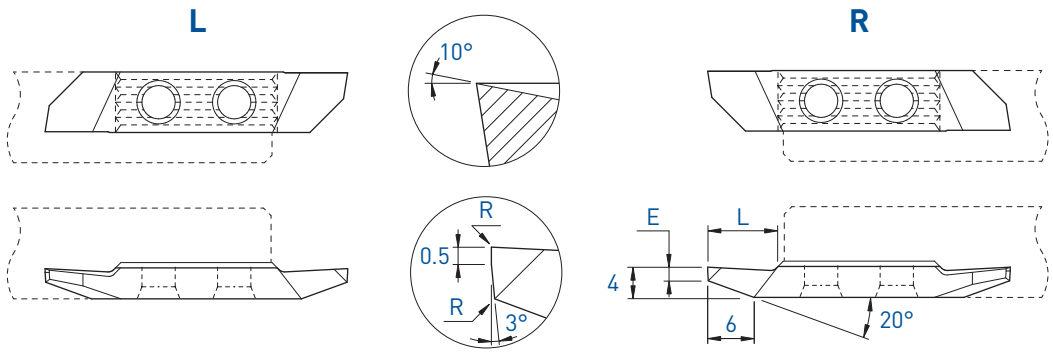

E	L	R	Art. N°	TiAlN	TiN	N (µk20)	HTA	HTiN	HN (µk10)	Art. N°	TiAlN	TiN	N (µk20)	HTA	HTiN	HN (µk10)
1.8	9	0	753XS-1.8	■	■	■				763XS-1.8	■	■	■	■	□	■
1.8	9	0.20	753XS-1.8-R20	■	■	■				763XS-1.8-R20	■	■	■			

7XX-XX-B

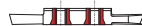

Sur demande pour serrage type B, voir page 1.03
Wahlweise mit B-Spannsystem, siehe Seite 1.03
On request for B clamping system, see page 1.03

■ = disponible / verfügbar / available
□ = selon disponibilité du stock / jenach Lagerverfügbarkeit / depending on stock availability

TOP-LINE

Tournage arrière
Rückwärts drehen
Back turning

753VX-8° / 763VX-8°

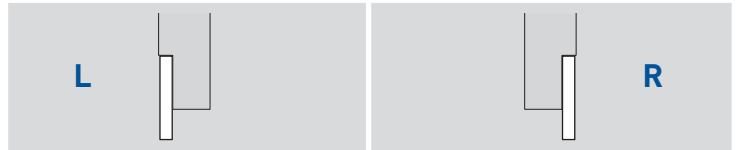
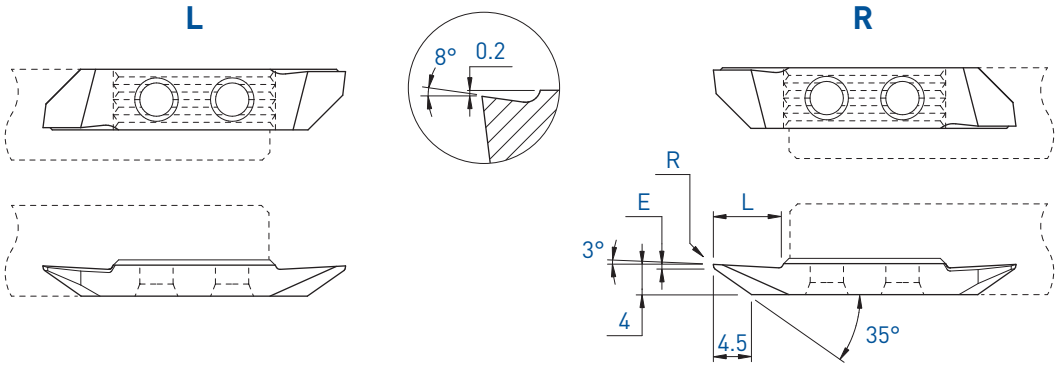

E	L	R	Art. N°	TiAlN	TiN	N (µk20)	HTA	HTiN	HN (µk10)	Art. N°	TiAlN	TiN	N (µk20)	HTA	HTiN	HN (µk10)
1.0	9	0	753VX-8°	■	■	■				763VX-8°	■	■	■	■	■	■
1.0	9	0.08	753VX-8°-R08	■	■	■				763VX-8°-R08	■	■	■	■	□	■
1.0	9	0.20	-							763VX-8°-R20	■	■	■			

7XX-XX-B

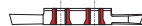

Sur demande pour serrage type B, voir page 1.03
Wahlweise mit B-Spannsystem, siehe Seite 1.03
On request for B clamping system, see page 1.03

Tournage arrière
 Rückwärts drehen
 Back turning

753VX-805 / 763VX-805

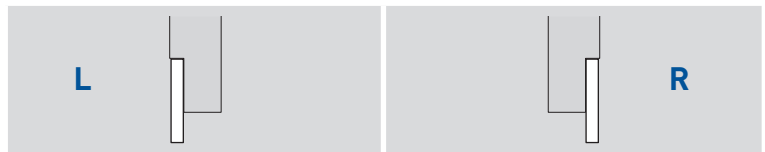
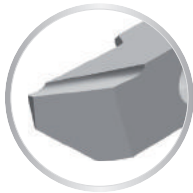
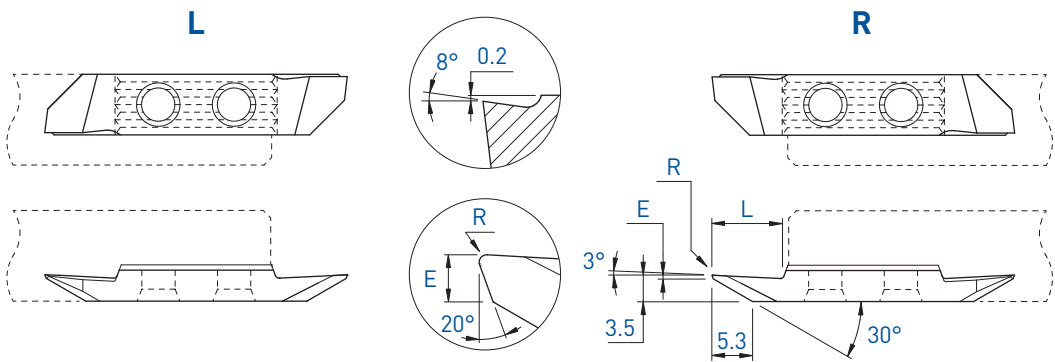

E	L	R	Art. N°	TiAlN	TiN	N (µk20)	HTA	HTiN	HN (µk10)	Art. N°	TiAlN	TiN	N (µk20)	HTA	HTiN	HN (µk10)
0.5	9	0.08	753VX-805-R08	■	■	■	■	□	■	763VX-805-R08	■	■	■	■	□	■

7XX-XX-B



Sur demande pour serrage type B, voir page 1.03
 Wahlweise mit B-Spannsystem, siehe Seite 1.03
 On request for B clamping system, see page 1.03

■ = disponible / verfügbar / available
 □ = selon disponibilité du stock / jenach Lagerverfügbarkeit / depending on stock availability

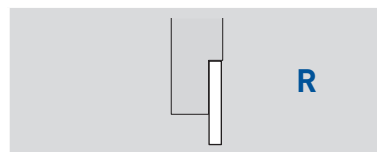
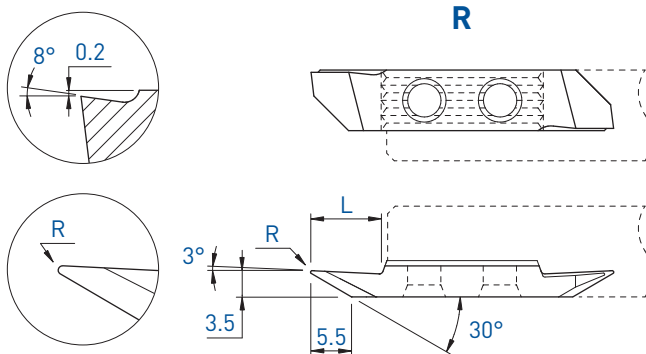

L	R	Art. N°	TiAlN	TiN	N (μk20)	HTA	HTiN	HN (μk10)
9	0.08	763VX-800-R08	■	■	■	■	□	■
9	0.20	763VX-800-R20	■	■	■	■	□	■

7XX-XX-B



Sur demande pour serrage type B, voir page 1.03
Wahlweise mit B-Spannsystem, siehe Seite 1.03
On request for B clamping system, see page 1.03

Tournage arrière
Rückwärts drehen
Back turning

753VX-15° / 763VX-15°

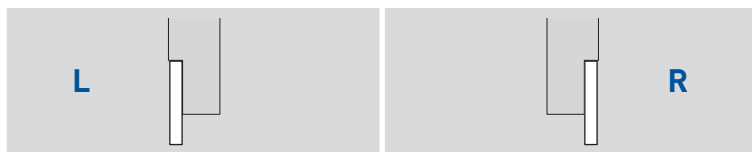
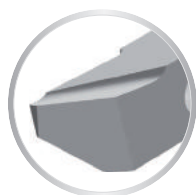
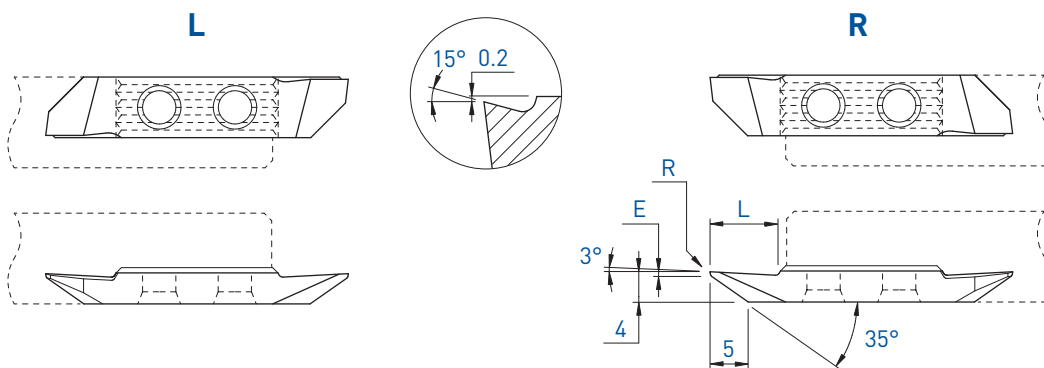

			L				R									
E	L	R	Art. N°	TiAlN	TiN	N (µk20)	HTA	HTiN	HN (µk10)	Art. N°	TiAlN	TiN	N (µk20)	HTA	HTiN	HN (µk10)
0.6	9	0	753VX-15°	■	■	■				763VX-15°	■	■	■	■	□	■
0.6	9	0.08	753VX-15°-R08	■	■	■				763VX-15°-R08	■	■	■	■	□	■

7XX-XX-B



Sur demande pour serrage type B, voir page 1.03
Wahlweise mit B-Spannsystem, siehe Seite 1.03
On request for B clamping system, see page 1.03

■ = disponible / verfügbar / available
□ = selon disponibilité du stock / jenach Lagerverfügbarkeit / depending on stock availability

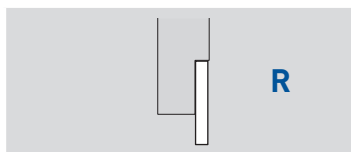
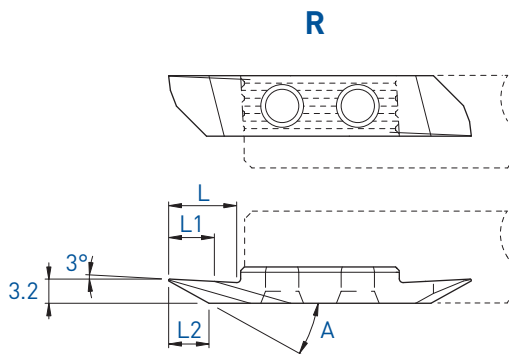
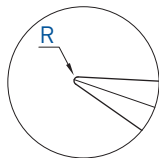
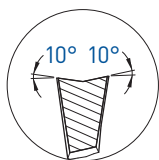

L	L1	L2	A	R	Art. N°	TiAlN	N [µk20]	HTA	HN [µk10]
9	6	5.5	29	0.08	763VUX10-29°-R08	■	■	■	■
9	6	5.3	29	0.15	763VUX10-29°-R15	■	■	■	■
9	6	4.7	29	0.35	763VUX10-29°-R35	■	■	■	■
9	6	3.6	29	0.75	763VUX10-29°-R75	■	■	■	■
9	6	4.2	35	0.15	763VUX10-35°-R15	■	■	■	■
9	6	3.8	35	0.35	763VUX10-35°-R35	■	■	■	■

7XX-XX-B



Sur demande pour serrage type B, voir page 1.03
Wahlweise mit B-Spannsystem, siehe Seite 1.03
On request for B clamping system, see page 1.03

Tournage arrière
Rückwärts drehen
Back turning

753ZX / 763ZX

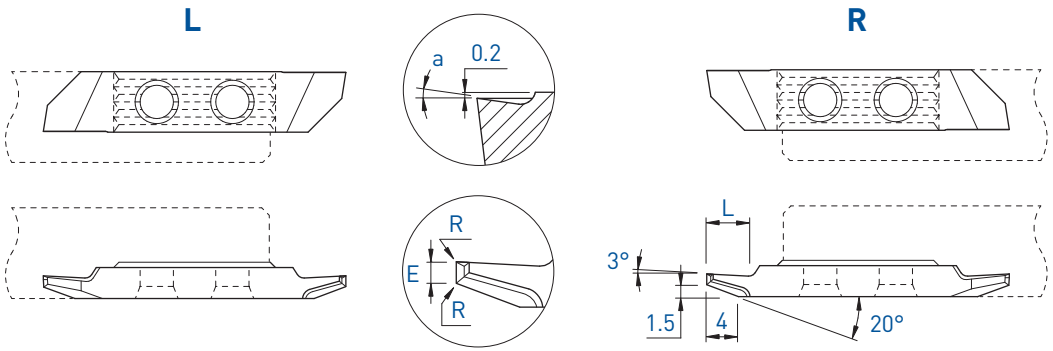

Pour un meilleur contrôle des copeaux
Für eine bessere Spankontrolle
For a better chip-control



a	E	L	R	Art. N°	TiAIN	TiN	N (µk20)	Art. N°	TiAIN	TiN	N (µk20)
10°	1.0	5	0.01	753ZX10-1.0	■	□		763ZX10-1.0	■	■	
	1.0	5	0.08	-				763ZX10-1.0-R08	■	■	
	1.0	5	0.20	-				763ZX10-1.0-R20	■	■	

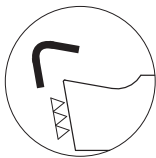

Arête de coupe honée
Gehonte Schneidkante
Honed edge

f min: 0.02 mm/U

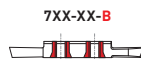

7XX-XX-B

Sur demande pour serrage type B, voir page 1.03
Wahlweise mit B-Spannsystem, siehe Seite 1.03
On request for B clamping system, see page 1.03

TOP-LINE

Tournage arrière / pré-coupe
 Rückwärts drehen / vorstechen
 Back turning / pre-parting off

753P / 763P

L

R

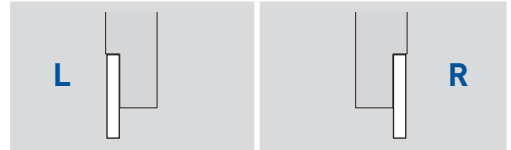
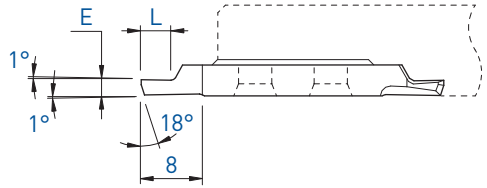
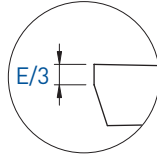
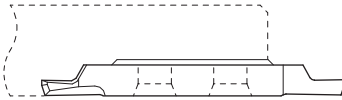
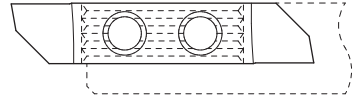
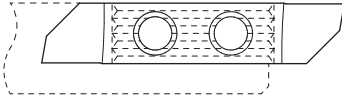

E	L	Art. N°	TiAlN	TiN	N (µk20)	Art. N°	TiAlN	TiN	N (µk20)
1.5	3	753P-1.5	■	■	■	763P-1.5	■	■	■
1.8	3.5	753P-1.8	■	■	■	763P-1.8	■	■	■
2.0	4	753P-2.0	■	■	■	763P-2.0	■	■	■
2.2	5	753P-2.2	■	■	■	763P-2.2	■	■	■
2.5	6	753P-2.5	■	■	■	763P-2.5	■	■	■
3.0	6	753P-3.0	■	■	■	763P-3.0	■	■	■

7XX-XX-B



Sur demande pour serrage type B, voir page 1.03
 Wahlweise mit B-Spannsystem, siehe Seite 1.03
 On request for B clamping system, see page 1.03

Fonçage-tournage

Einstecken und drehen

Grooving and turning

754 / 764

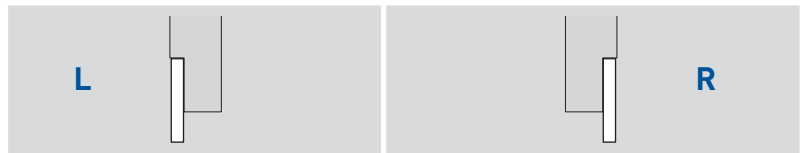
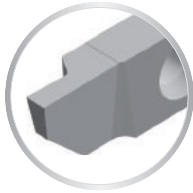
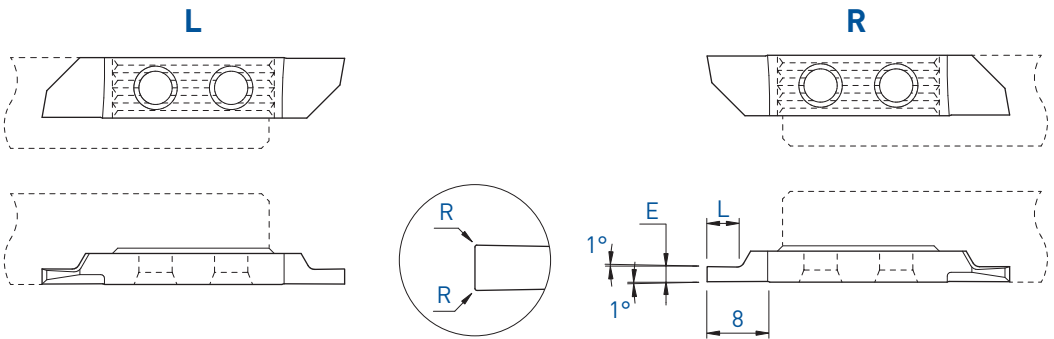

E	L	R	Art. N°	L			R			Art. N°	L			R				
				TiAlN	TiN	N (µk20)	HTA	HTiN	HN (µk10)		TiAlN	TiAlX	TiN	N (µk20)	HTA	HTiN	HN (µk10)	
0.5	1.5	0	754-0.5	■	■	■				764-0.5	■	■	■	■	■	■	■	
0.75	2	0	754-0.75	■	■	■				764-0.75	■	■	■	■	■	■	■	
0.8	2	0	-							764-0.8	■	■	■	■	■	■		
0.95	3	0	754-0.95	■	■	■	■	□	■	764-0.95	■	■	■	■	■	■		
1.0	2.5	0	754-1.0	■	■	■	■	□	■	764-1.0	■	■	■	■	■	■		
1.0	2.5	0.08	754-1.0-R08	■	■	■	■	□	■	764-1.0-R08	■	■	■	■	■	□	■	
1.2	3	0	754-1.2	■	■	■	■			764-1.2	■	■	■	■	■	□	■	
1.5	3	0	754-1.5	■	■	■	■	□	■	764-1.5	■	■	■	■	■	■	■	
1.5	3	0.08	754-1.5-R08	■	■	■	■	□	■	764-1.5-R08	■	■	■	■	■	□	■	
1.5	3	0.15	-							764-1.5-R15	■	■	□	■	■	■	■	
1.5	3	0.20	-							764-1.5-R20	■	■	■	■	■	□	■	
1.8	4	0	754-1.8	■	■	■	■			764-1.8	■	■	■	■	■	■	■	
2.0	4	0	754-2.0	■	■	■	■	□	■	764-2.0	■	■	■	■	■	■	■	
2.0	4	0.08	754-2.0-R08	■	■	■	■	□	■	764-2.0-R08	■	■	■	■	■	■	□	■
2.0	4	0.15	-							764-2.0-R15	■	■	□	■	■	■	■	
2.0	4	0.20	754-2.0-R20	■	■	■	■			764-2.0-R20	■	■	■	■	■	■	■	
2.5	6	0	754-2.5	■	■	■	■			764-2.5	■	■	■	■	■	□	■	
2.5	6	0.15	-							764-2.5-R15	■	■	□	■	■	■	■	
2.5	6	0.20	-							764-2.5-R20	■	■	■	■	■	□	■	
3.0	6	0	754-3.0	■	■	■	■	□	■	764-3.0	■	■	■	■	■	□	■	
3.0	6	0.08	754-3.0-R08	■	■	■	■			764-3.0-R08	■	■	■	■	■	□	■	
3.0	6	0.15	-							764-3.0-R15	■	■	□	■	■	■	■	
3.0	6	0.20	754-3.0-R20	■	■	■	■	□	■	764-3.0-R20	■	■	■	■	■	■	■	
4.0	8	0	754-4.0	■	■	■	■	■	■	764-4.0	■	■	■	■	■	□	■	

7XX-XX-B



Sur demande pour serrage type B, voir page 1.03
 Wahlweise mit B-Spannsystem, siehe Seite 1.03
 On request for B clamping system, see page 1.03

■ = disponible / verfügbar / available
 □ = selon disponibilité du stock / jenach Lagerverfügbarkeit / depending on stock availability

TOP-LINE

Fonçage-tournage
Einstecken und drehen
Grooving and turning

754VS / 764VS

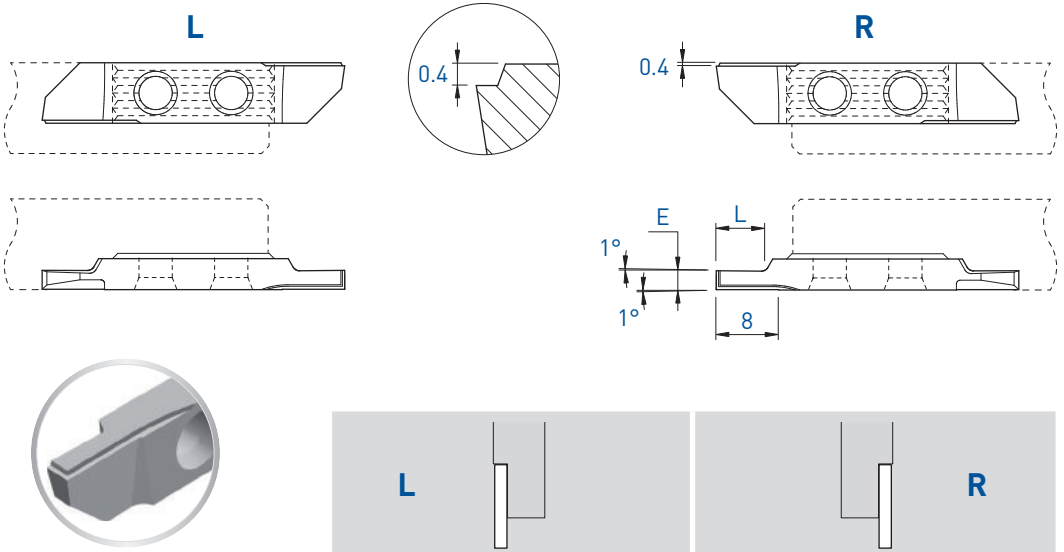

		L						R							
E	L	Art. N°	TiAlN	TiN	N (µk20)	HTA	HTiN	HN (µk10)	Art. N°	TiAlN	TiN	N (µk20)	HTA	HTiN	HN (µk10)
1.0	2	754VS-1.0	■	■	■				764VS-1.0	■	■	■			
1.2	2.5	754VS-1.2	■	■	■		□	■	764VS-1.2	■	■	■			
1.5	3	754VS-1.5	■	■	■				764VS-1.5	■	■	■			
2.0	4	754VS-2.0	■	■	■				764VS-2.0	■	■	■			
2.5	6	754VS-2.5	■	■	■				764VS-2.5	■	■	■	■	□	■
3.0	6	754VS-3.0	■	■	■				764VS-3.0	■	■	■			

7XX-XX-B



Sur demande pour serrage type B, voir page 1.03
Wahlweise mit B-Spannsystem, siehe Seite 1.03
On request for B clamping system, see page 1.03

Fonçage-tournage

Einstecken und drehen

Grooving and turning

754X / 764X

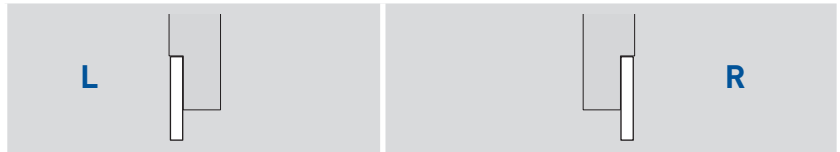
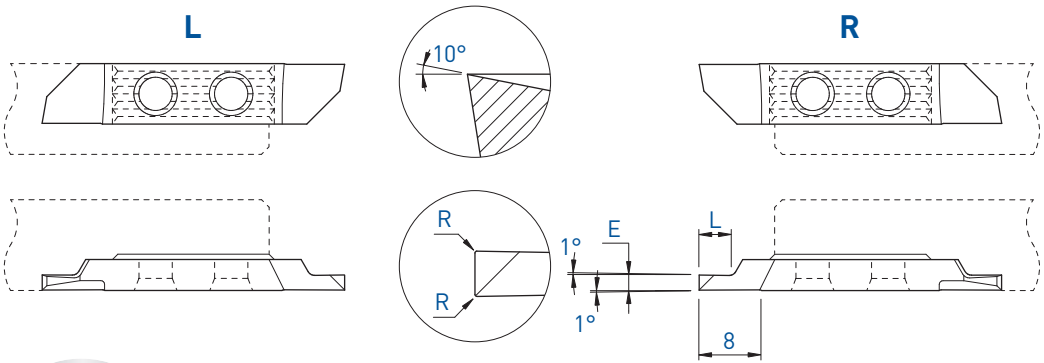

E	L	R	Art. N°	TiAlN	TiN	N (µk20)	HTA	HTiN	HN (µk10)	Art. N°	TiAlN	TiAlX	LoX	TiN	N (µk20)	HTA	HTiN	HN (µk10)
1.0	2.5	0	754X-1.0	■	■	■	■	■	■	764X-1.0	■	■	■	■	■	■	□	■
1.0	2.5	0.08	754X-1.0-R08	■	■	■	■	□	■	764X-1.0-R08	■	■	■	■	■	■	□	■
1.0	2.5	0.20	-							764X-1.0-R20	■	■	■	■	■			
1.2	3	0	754X-1.2	■	■	■				764X-1.2	■	■	■	■	■		□	■
1.2	3	0.08	-							764X-1.2-R08	■	■	■	■	■			
1.5	3	0	754X-1.5	■	■	■	■	□	■	764X-1.5	■	■	■	■	■		■	■
1.5	3	0.08	754X-1.5-R08	■	■	■	■	□	■	764X-1.5-R08	■	■	■	■	■		□	■
1.5	3	0.15	-							764X-1.5-R15	■	■	■	□	■		■	■
1.5	3	0.20	754X-1.5-R20	■	■	■	■			764X-1.5-R20	■	■	■	■	■		■	■
1.8	4	0	754X-1.8	■	■	■				764X-1.8	■	■	■	■	■		□	■
1.8	4	0.20	-							764X-1.8-R20	■	■	■	■	■			
2.0	4	0	754X-2.0	■	■	■	■	□	■	764X-2.0	■	■	■	■	■		■	■
2.0	4	0.08	754X-2.0-R08	■	■	■	■	□	■	764X-2.0-R08	■	■	■	■	■		□	■
2.0	4	0.15	-							764X-2.0-R15	■	■	■	□	■		■	■
2.0	4	0.20	754X-2.0-R20	■	■	■	■	□	■	764X-2.0-R20	■	■	■	■	■		□	■
2.0	4	0.35	-							764X-2.0-R35	■	■	■	□	■		■	■
2.5	6	0	754X-2.5	■	■	■	■	■	■	764X-2.5	■	■	■	■	■		■	■
2.5	6	0.15	-							764X-2.5-R15	■	■	■	□	■		■	■
2.5	6	0.20	754X-2.5-R20	■	■	■	■	□	■	764X-2.5-R20	■	■	■	■	■		□	■
2.5	6	0.35	-							764X-2.5-R35	■	■	■	□	■		■	■
3.0	6	0	754X-3.0	■	■	■				764X-3.0	■	■	■	■	■		□	■
3.0	6	0.08	754X-3.0-R08	■	■	■				764X-3.0-R08	■	■	■	■	■		□	■
3.0	6	0.15	-							764X-3.0-R15	■	■	■	□	■		■	■
3.0	6	0.20	754X-3.0-R20	■	■	■				764X-3.0-R20	■	■	■	■	■		□	■
3.0	6	0.35	-							764X-3.0-R35	■	■	■	□	■		■	■
4.0	8	0	754X-4.0	■	■	■				764X-4.0	■	■	■	■	■		□	■
4.0	8	0.20	754X-4.0-R20	■	■	■				764X-4.0-R20	■	■	■	■	■		□	■
4.0	8	0.35	-							764X-4.0-R35	■	■	■	□	■		■	■

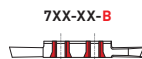

Sur demande pour serrage type B, voir page 1.03
Wahlweise mit B-Spannsystem, siehe Seite 1.03
On request for B clamping system, see page 1.03

■ = disponible / verfügbar / available
□ = selon disponibilité du stock / jenach Lagerverfügbarkeit / depending on stock availability

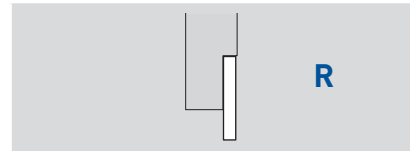
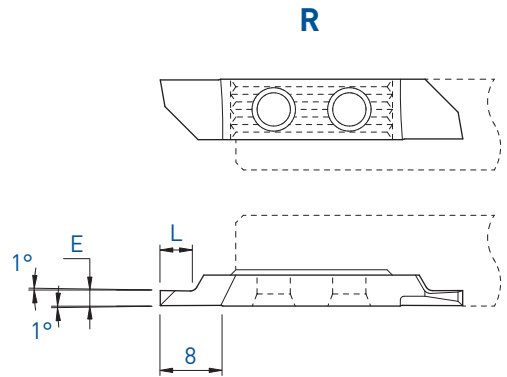
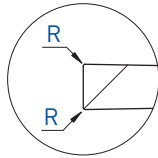
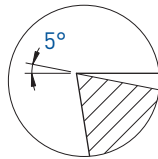

E	L	R	Art. N°	TiAIN	TiAlX	LOX	TiN	N (µm20)
1.5	3	0.08	764X5-1.5-R08-EP	■	■	■	■	■
2.0	4	0.08	764X5-2.0-R08-EP	■	■	■	■	■
2.5	6	0.08	764X5-2.5-R08-EP	■	■	■	■	■
2.5	6	0.15	764X5-2.5-R15-EP	■	■	■	■	■
3.0	6	0.08	764X5-3.0-R08-EP	■	■	■	■	■
3.0	6	0.15	764X5-3.0-R15-EP	■	■	■	■	■
4.0	8	0.15	764X5-4.0-R15-EP	■	■	■	■	■
4.0	8	0.35	764X5-4.0-R35-EP	■	■	■	■	■

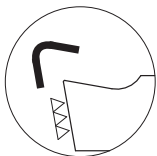

Arête de coupe honée
Gehonte Schneidkante
Honed edge



Sur demande pour serrage type B, voir page 1.03
Wahlweise mit B-Spannsystem, siehe Seite 1.03
On request for B clamping system, see page 1.03

Fonçage-tournage

Einstecken und drehen

Grooving and turning

764X10-EP

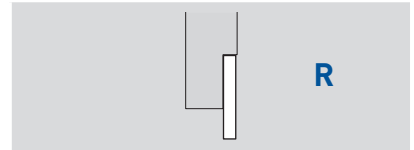
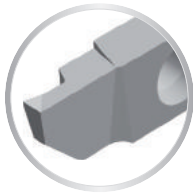
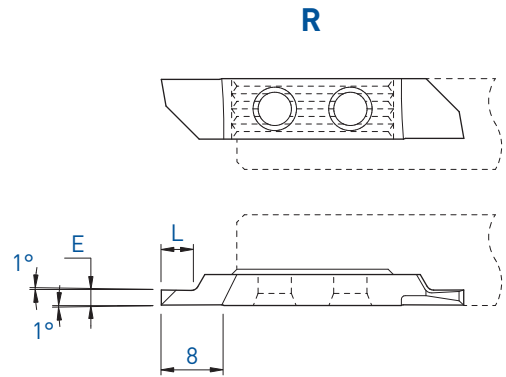
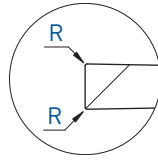
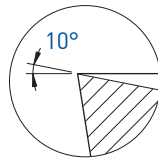

E	L	R	Art. N°	TiAIN	TiAlX	LoX	TiN	N (µm20)
1.5	3	0.08	764X10-1.5-R08-EP	■	■	■	■	■
2.0	4	0.08	764X10-2.0-R08-EP	■	■	■	■	■
2.5	6	0.08	764X10-2.5-R08-EP	■	■	■	■	■
2.5	6	0.15	764X10-2.5-R15-EP	■	■	■	■	■
3.0	6	0.08	764X10-3.0-R08-EP	■	■	■	■	■
3.0	6	0.15	764X10-3.0-R15-EP	■	■	■	■	■
4.0	8	0.15	764X10-4.0-R15-EP	■	■	■	■	■
4.0	8	0.35	764X10-4.0-R35-EP	■	■	■	■	■

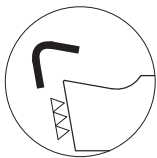

Arête de coupe honée
Gehonte Schneidkante
Honed edge



7XX-XX-B
Sur demande pour serrage type B, voir page 1.03
Wahlweise mit B-Spannsystem, siehe Seite 1.03
On request for B clamping system, see page 1.03

■ = disponible / verfügbar / available
□ = selon disponibilité du stock / jenach Lagerverfügbarkeit / depending on stock availability

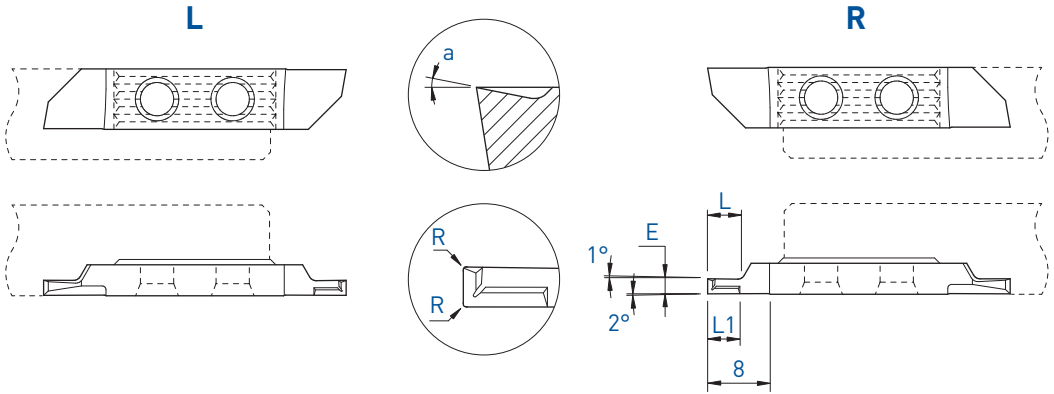

Pour un meilleur contrôle des copeaux
Für eine bessere Spankontrolle
For a better chip-control



a	E	L	L1	R	Art. N°	TiAlN				Art. N°	TiAlN					
						Ti	Al	N	HN (µk10)		Ti	Al	N	HN (µk10)		
10°	1.5	4	4	0.03	754ZX10-1.5-R03	■	□			764ZX10-1.5-R03	■	■	■			
	1.5	4	4	0.08	754ZX10-1.5-R08	■	□			764ZX10-1.5-R08	■	■	■			
	2.0	4	4	0.08	754ZX10-2.0-R08	■	□			764ZX10-2.0-R08	■	■	■			
	2.0	4	4	0.20	-					764ZX10-2.0-R20	■	■	□			
	2.5	5	5	0.08	754ZX10-2.5-R08	■	■			764ZX10-2.5-R08	■	■	■			
	2.5	5	5	0.20	-					764ZX10-2.5-R20	■	■	■			
	3.0	6	6	0.08	754ZX10-3.0-R08	■	□			764ZX10-3.0-R08	■	■	■			
	3.0	6	6	0.20	-					764ZX10-3.0-R20	■	■	■			
25°	4.0	6	6	0.20	-					764ZX10-4.0-R20	■	■	□			
	2.0	4	4	0.08	-					764ZX25-2.0-R08				■	■	□
	2.0	4	4	0.20	-					764ZX25-2.0-R20				■	■	□
	2.5	5	5	0.08	-					764ZX25-2.5-R08				■	■	□
2.5	5	5	0.20	-					764ZX25-2.5-R20				■	■	□	

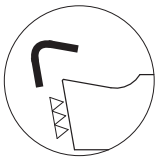

Arête de coupe honée
Gehonte Schneidkante
Honed edge

f min: 0.02 mm/U



7XX-XX-B

Sur demande pour serrage type B, voir page 1.03
Wahlweise mit B-Spannsystem, siehe Seite 1.03
On request for B clamping system, see page 1.03

Fonçage-tournage

Einstechen und drehen

Grooving and turning

764ZXB

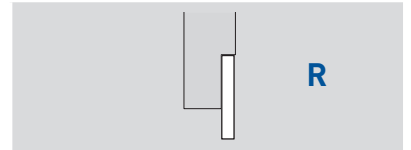
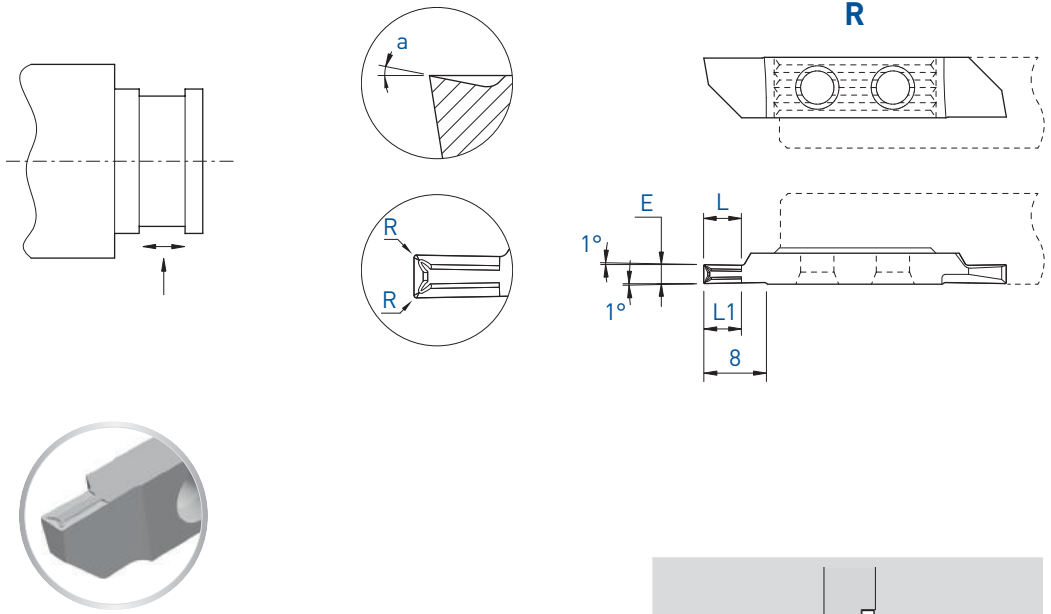

a	E	L	L1	R	Art. N°	TiAlN	TiAlX	LoX	TiN	N (µm20)
10°	1.5	4	4	0.08	764ZXB10-1.5-R08	■	■	■	□	
	2.0	4	4	0.08	764ZXB10-2.0-R08	■	■	■	□	
	2.0	4	4	0.15	764ZXB10-2.0-R15	■	■	■	□	
	2.0	4	4	0.35	764ZXB10-2.0-R35	■	■	■	□	
	2.5	5	5	0.08	764ZXB10-2.5-R08	■	■	■	□	
	2.5	5	5	0.15	764ZXB10-2.5-R15	■	■	■	□	
	2.5	5	5	0.35	764ZXB10-2.5-R35	■	■	■	□	
	3.0	6	6	0.08	764ZXB10-3.0-R08	■	■	■	□	
	3.0	6	6	0.15	764ZXB10-3.0-R15	■	■	■	□	
3.0	6	6	0.35	764ZXB10-3.0-R35	■	■	■	□		

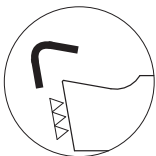

Arête de coupe honée
Gehonte Schneidkante
Honed edge

f min: 0.02 mm/U



7XX-XX-B

Sur demande pour serrage type B, voir page 1.03
Wahlweise mit B-Spannsystem, siehe Seite 1.03
On request for B clamping system, see page 1.03

■ = disponible / verfügbar / available

□ = selon disponibilité du stock / jenach Lagerverfügbarkeit / depending on stock availability

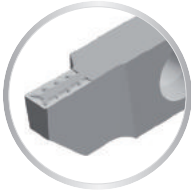
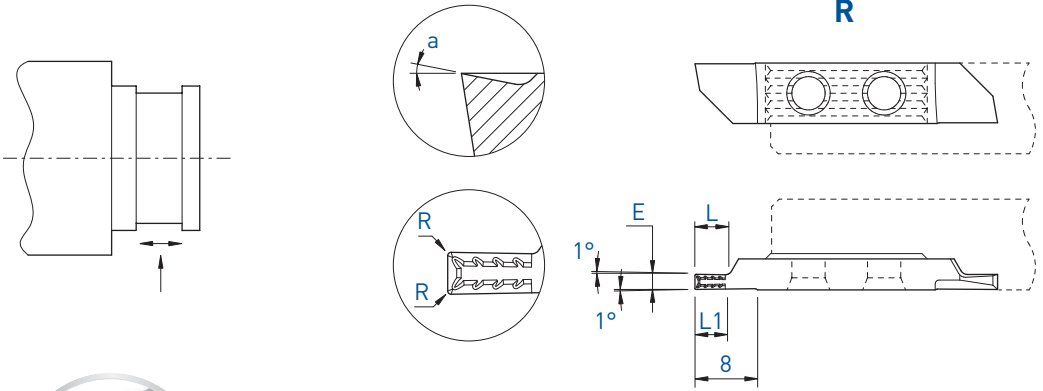

Pour un meilleur contrôle des copeaux
Für eine bessere Spankontrolle
For a better chip-control

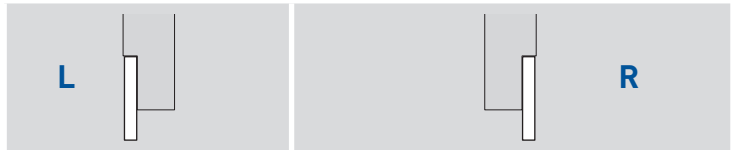

a	E	L	L1	R	Art. N°	L			R				HTA	HN (µk10)	
						TiAlN	TiN	N (µk20)	TiAlN	TiAlX	LOX	TiN			N (µk20)
10°	1.5	4	4	0.03	-				764ZXT10-1.5-R03	■	■	■	□		
	1.5	4	4	0.08	754ZXT10-1.5-R08	■	□		764ZXT10-1.5-R08	■	■	■	□		
	1.5	4	4	0.20	754ZXT10-1.5-R20	■			-						
	2.0	4	4	0.08	754ZXT10-2.0-R08	■	□		764ZXT10-2.0-R08	■	■	■	□		
	2.0	4	4	0.20	754ZXT10-2.0-R20	■			764ZXT10-2.0-R20	■	■	■	□		
	2.0	4	4	0.40	-				764ZXT10-2.0-R40	■	■	■			
	2.5	5	5	0.08	754ZXT10-2.5-R08	■	□		764ZXT10-2.5-R08	■	■	■	□		
	2.5	5	5	0.20	754ZXT10-2.5-R20	■			764ZXT10-2.5-R20	■	■	■	□		
	2.5	5	5	0.40	-				764ZXT10-2.5-R40	■	■	■			
	3.0	6	6	0.08	754ZXT10-3.0-R08	■	□		764ZXT10-3.0-R08	■	■	■	□		
	3.0	6	6	0.20	-				764ZXT10-3.0-R20	■	■	■	□	■	
	3.0	6	6	0.40	-				764ZXT10-3.0-R40	■	■	■	□		
	4.0	8	8	0.20	-				764ZXT10-4.0-R20	■	■	■	□		
	4.0	8	8	0.40	-				764ZXT10-4.0-R40	■	■	■	□		
4.0	8	8	0.80	-				764ZXT10-4.0-R80	■	■	■				

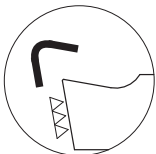

Arête de coupe honée
Gehonte Schneidkante
Honed edge

f min: 0.02 mm/U



7XX-XX-B

Sur demande pour serrage type B, voir page 1.03
Wahlweise mit B-Spannsystem, siehe Seite 1.03
On request for B clamping system, see page 1.03

Filetage

Gewinde drehen

Threading

756 / 766

L

R

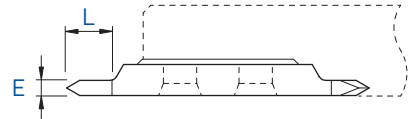
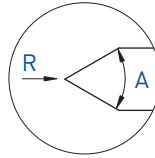
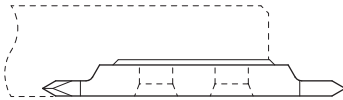
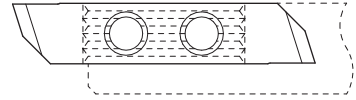
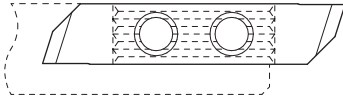

L



R



A	E	L	R	Art. N°	TiAlN	TiN	N (µk20)	HTA	HTiN	HN (µk10)	Art. N°	TiAlN	TiN	N (µk20)	HTA	HTiN	HN (µk10)
60°	2.0	6	-	756-60-2.0	■	■	■				766-60-2.0	■	■	■			
60°	2.0	6	0.02	756-60-2.0-R02	■	■	■	■	□	■	766-60-2.0-R02	■	■	■	■	□	■
60°	3.0	8	-	756-60-3.0	■	■	■				766-60-3.0	■	■	■			
60°	3.0	8	0.02	756-60-3.0-R02	■	■	■	■	□	■	766-60-3.0-R02	■	■	■	■	□	■
55°	2.0	6	-	756-55-2.0	■	■	■				766-55-2.0	■	■	■			
55°	2.0	6	0.02	756-55-2.0-R02	■	■	■				766-55-2.0-R02	■	■	■			
55°	3.0	8	-	756-55-3.0	■	■	■				766-55-3.0	■	■	■			
55°	3.0	8	0.02	756-55-3.0-R02	■	■	■				766-55-3.0-R02	■	■	■			

7XX-XX-B



Sur demande pour serrage type B, voir page 1.03
Wahlweise mit B-Spannsystem, siehe Seite 1.03
On request for B clamping system, see page 1.03

■ = disponible / verfügbar / available
□ = selon disponibilité du stock / jenach Lagerverfügbarkeit / depending on stock availability

- Filetage
- Gewinde drehen
- Threading

756-AG60° / 766-AG60°
756-G60° / 766-G60°

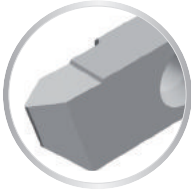
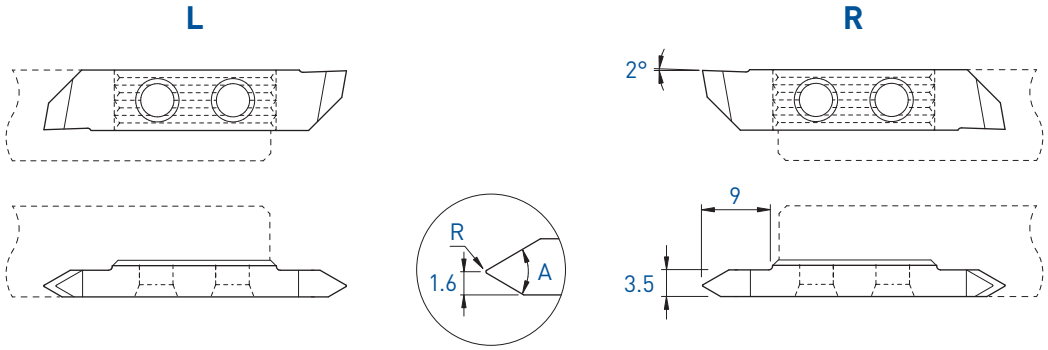

Profil partiel
Teilprofil
Partial profile



			L			R				
A	R	Pas Steigung Pitch P	Art. N°	TiAIN	TiN	N (µk20)	Art. N°	TiAIN	TiN	N (µk20)
60°	0.06	0.50-1.50	756-AG60°	■	■	■	766-AG60°	■	■	■
60°	0.20	1.75-3.00	756-G60°	■	■	■	766-G60°	■	■	■

7XX-XX-B



Sur demande pour serrage type B, voir page 1.03
Wahlweise mit B-Spannsystem, siehe Seite 1.03
On request for B clamping system, see page 1.03

Filetage
Gewinde drehen
Threading

756-M / 766-M

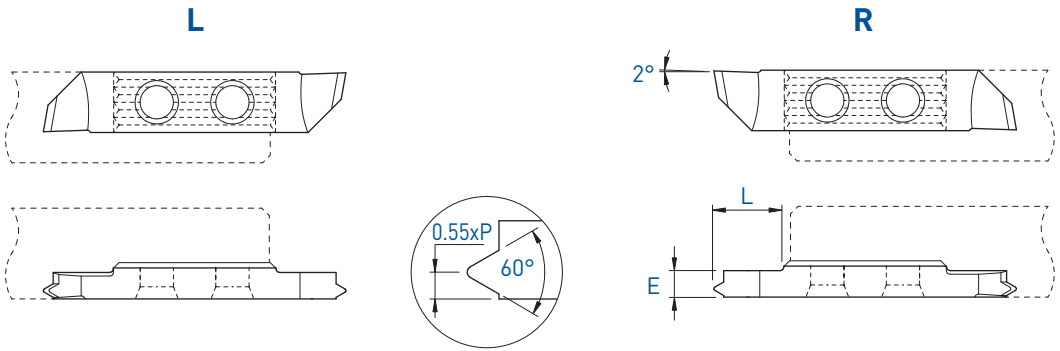

Profil complet métrique
Metrisches Vollprofil
Metric full profile

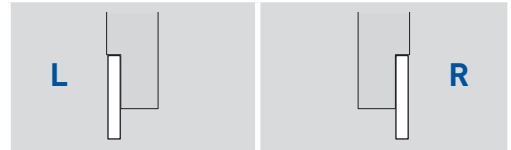

E	L	Pas Steigung Pitch P	L			R				
			Art. N°	TiAIN	TiN	N (µk20)	Art. N°	TiAIN	TiN	N (µk20)
2.5	8	0.80	756-M-0.80	■	■	■	766-M-0.80	■	■	■
2.5	8	1.00	756-M-1.00	■	■	■	766-M-1.00	■	■	■
2.5	8	1.25	756-M-1.25	■	■	■	766-M-1.25	■	■	■
3.5	9	1.50	756-M-1.50	■	■	■	766-M-1.50	■	■	■
3.5	9	1.75	756-M-1.75	■	■	■	766-M-1.75	■	■	■
3.5	9	2.00	756-M-2.00	■	■	■	766-M-2.00	■	■	■

Pour de plus petits pas, voir page 1.65
Für kleinere Steigungen, siehe Seite 1.65
For smaller pitches, see page 1.65

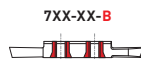

Sur demande pour serrage type B, voir page 1.03
Wahlweise mit B-Spannsystem, siehe Seite 1.03
On request for B clamping system, see page 1.03

■ = disponible / verfügbar / available
□ = selon disponibilité du stock / jenach Lagerverfügbarkeit / depending on stock availability

new

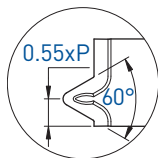
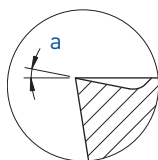

R

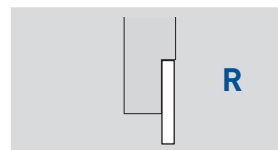
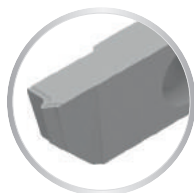
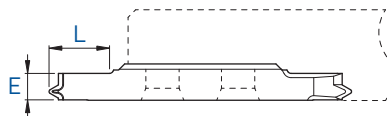
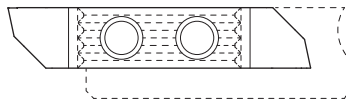

a	E	L	P	Art. N°	TiAIN	LOX
10°	2.5	8	0.80	766ZX10-M-0.80	■	□
	2.5	8	1.00	766ZX10-M-1.00	■	□
	2.5	8	1.25	766ZX10-M-1.25	■	□
	3.5	9	1.50	766ZX10-M-1.50	■	□
	3.5	9	1.75	766ZX10-M-1.75	■	□
	3.5	9	2.00	766ZX10-M-2.00	■	□

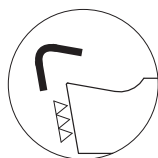

Arête de coupe honée
Gehonte Schneidkante
Honed edge

7XX-XX-B



Sur demande pour serrage type B, voir page 1.03
Wahlweise mit B-Spannsystem, siehe Seite 1.03
On request for B clamping system, see page 1.03

Plaquettes à rayon
 Radius Wendeplatten
 Radius inserts

757 / 767

L

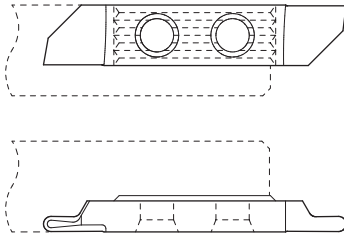

R

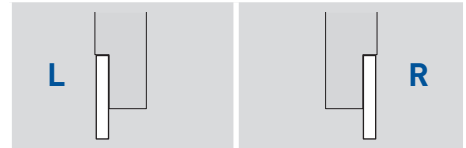
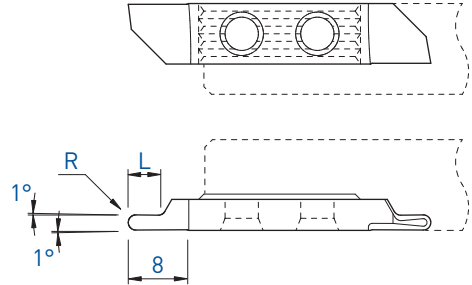

R	L	Art. N°	TiAlN			Art. N°	TiN		
			Ti	Al	N		Ti	Al	N
0.5	2.5	757-R0.5	■	■	■	767-R0.5	■	■	■
1.0	4	757-R1.0	■	■	■	767-R1.0	■	■	■
1.5	6	757-R1.5	■	■	■	767-R1.5	■	■	■
2.0	8	757-R2.0	■	■	■	767-R2.0	■	■	■

7XX-XX-B



Sur demande pour serrage type B, voir page 1.03
 Wahlweise mit B-Spannsystem, siehe Seite 1.03
 On request for B clamping system, see page 1.03

■ = disponible / verfügbar / available
 □ = selon disponibilité du stock / jenach Lagerverfügbarkeit / depending on stock availability

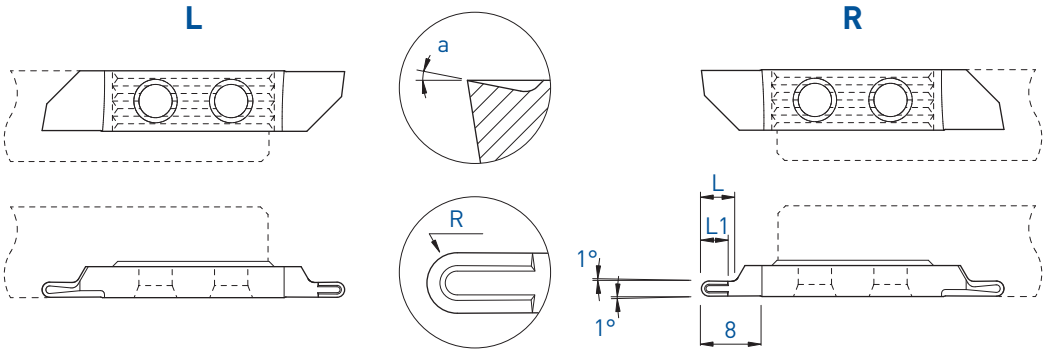

Pour un meilleur contrôle des copeaux
 Für eine bessere Spankontrolle
 For a better chip-control

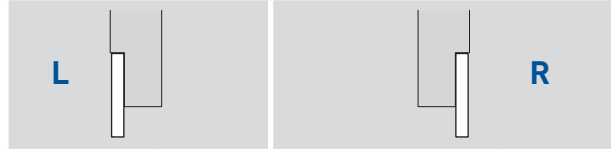

a	R	L	L1	Art. N°	L			Art. N°	R			
					TiAlN	TiN	N (µk20)		TiAlN	TiN	N (µk20)	HTA
10°	1.0	4	3.5	757ZX10-R1.0	■	□		767ZX10-R1.0	■	□		
	1.5	6	4.0	757ZX10-R1.5	■	□		767ZX10-R1.5	■	□		
	2.0	8	4.5	757ZX10-R2.0	■	□		767ZX10-R2.0	■	□	■	



Arête de coupe honée
 Gehonte Schneidkante
 Honed edge

f min: 0.02 mm/U

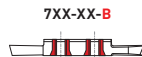

7XX-XX-B Sur demande pour serrage type B, voir page 1.03
 Wahlweise mit B-Spannsystem, siehe Seite 1.03
 On request for B clamping system, see page 1.03

Plaquettes ébauches
WSP-Rohlinge
Blank inserts

751-E / 761-E
751-EP / 761-EP

L

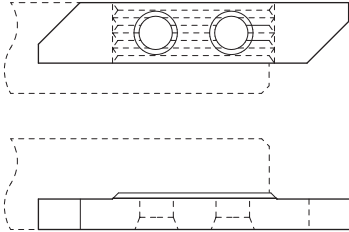

R

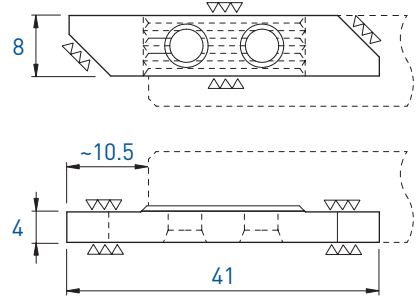

7XX-XX-B



Sur demande pour serrage type B, voir page 1.03
Wahlweise mit B-Spannsystem, siehe Seite 1.03
On request for B clamping system, see page 1.03

L

Art. N°	N (µk20)	HN (µk10)
751-E	■	■

R

Art. N°	N (µk20)	HN (µk10)
761-E	■	■

L

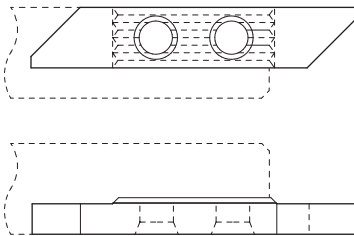

R

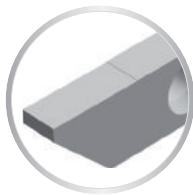
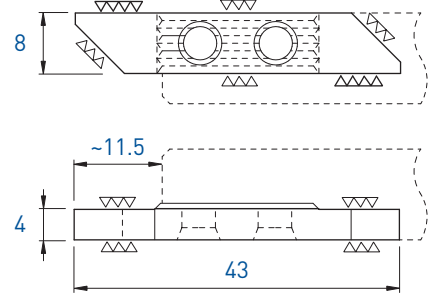

Face de coupe polie
Polierte Schneidfläche
Polished cutting face

L

Art. N°	TiAlN	TiN	N (µk20)	HTA	HTiN	HN (µk10)
751-EP	■	■	■	□	□	■

R

Art. N°	TiAlN	TiN	N (µk20)	HTA	HTiN	HN (µk10)
761-EP	■	■	■	■	□	■

770 / 780

7050 / 7060

W750 / W760

Porte-outils spécifiques

Spezifische Werkzeughalter

Specific tool holders

770 / 780

Tronçonnage de grande capacité
Abstechen für grössere Durchmesser
High capacity parting

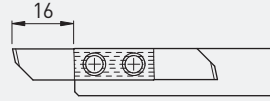

> **1.133**

7050 / 7060

Tronçonnage de grande capacité
Abstechen für grössere Durchmesser
High capacity parting

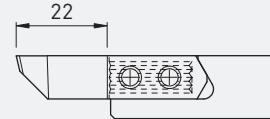

> **1.143**

W750 / W760

Outils avec plaquettes ébauchées larges pour profilage
Werkzeuge mit breiten WSP-Rohlingen für Profilschleifen
Tools with wide blank inserts for profiling

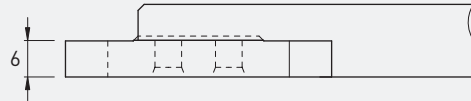

> **1.149**

Porte-outils spécifiques / Spezifische Werkzeughalter / Specific tool holders

POLYGONAL INTERFACE C3 / C4 / HSK

> **1.153**

740Z / 760Z

Porte-outils pour usinage déporté
Halter für versetzte Bearbeitung
Holders for shifted machining

> **1.156**

DECO 7/10 - EvoDECO 10

R

> **1.157**

DECO 7/10 - EvoDECO 10

L

> **1.159**

Tornos

DECO 13 - EvoDECO 16

DECO 20/26 - EvoDECO 20/32

> **1.161**

MultiSwiss 6x16

> **1.163**

AS14 / SAS16

> **1.164**

Schütte

> **1.165**

Porte-outils

Halter

Holders

770 / 780

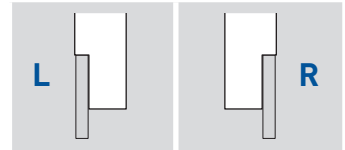
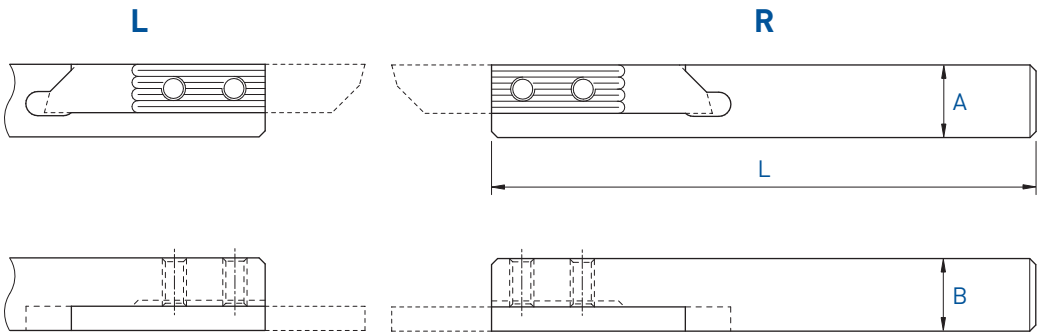

A x B	L	Serrage Spannsystem Clamping	Art. N°	Art. N°
10 x 10	115	A	770-10	780-10
12 x 12	130	A	770-12	780-12
12 x 12	90	A	770-12-90	780-12-90
12.7 x 12.7	130	A	770-12.7	780-12.7
14 x 14	130	A	770-14	780-14
16 x 16	130	A	770-16	780-16
16 x 16	75	A	770-16-75	780-16-75
20 x 20	120	A	770-20	780-20
25 x 25	140	A	770-25	780-25



Chaque support est livré avec vis et clé.
 Jeder Halter wird mit Spannschraube(n) und Schlüssel geliefert.
 Screw(s) and key are included with each tool holder.

Porte-outils avec arrosage intégré
Halter mit integrierter Kühlmittelzufuhr
Holders with integrated coolant supply

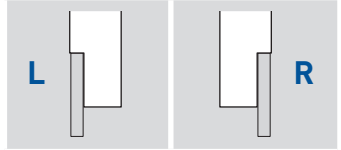
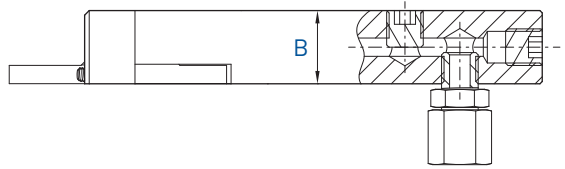
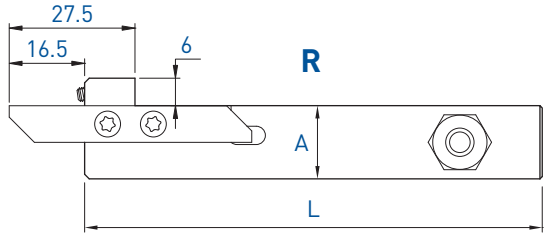
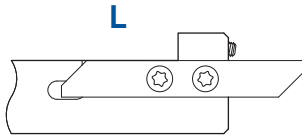

770-JET / 780-JET

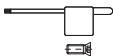

A x B	L	Serrage Spannsystem Clamping	Art. N°	Art. N°
16 x 16	100	A	770-16-JET	780-16-JET

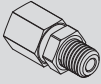

Chaque support est livré avec vis et clé.
 Jeder Halter wird mit Spannschraube(n)
 und Schlüssel geliefert.
 Screw(s) and key are included with each
 tool holder.

Pièces de rechange Ersatzteile Spare parts			Buse Düse Nozzle 
	Art. N°	Art. N°	Art. N°
770-JET / 780-JET	J-M8X1-D6	JB-M8X1	JJ-M3X6-D1.5

Porte-outils

Halter

Holders

Coupe déportée

Versetzttes Schneiden

Cut off line

770RC

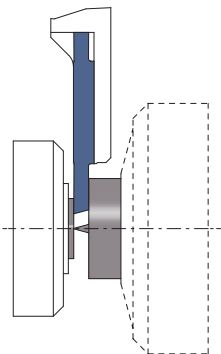
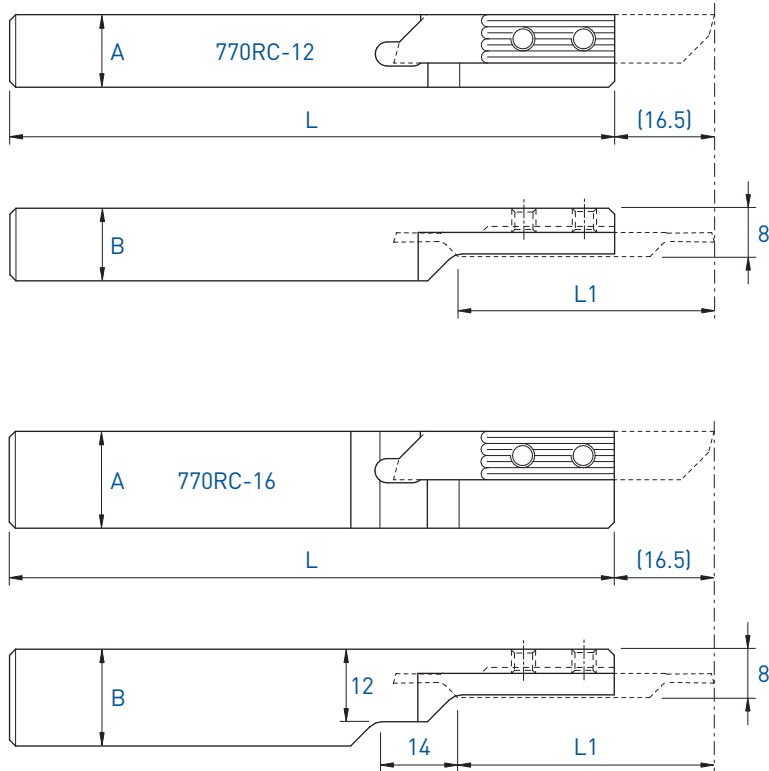

Utiliser des plaquettes type 771R
WSP Typ 771R verwenden
Use inserts type 771R

Voir pages 1.138 - 1.141
Siehe Seiten 1.138 - 1.141
See pages 1.138 - 1.141



Chaque support est livré avec vis et clé.
Jeder Halter wird mit Spannschraube(n) und Schlüssel geliefert.
Screw(s) and key are included with each tool holder.

L (R)

Coupe à droite déportée
Versetzttes Rechtsschneiden
Right cut off line

A x B	L	L1	Serrage Spannsystem Clamping	Art. N°
12 x 12	130	42	A	770RC-12
16 x 16	130	42	A	770RC-16

L

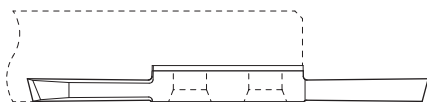
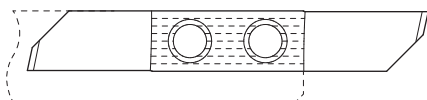

R

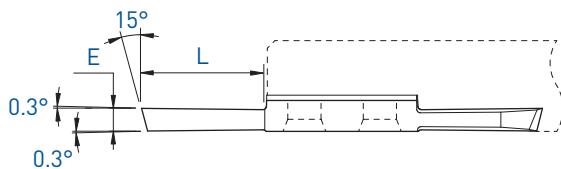
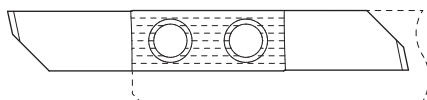

L



R



E	L	Art. N°	L			Art. N°	R		
			TiAlN	TiN	N (µk20)		TiAlN	TiN	N (µk20)
1.5	16	-				781-1.5	■	■	■
2.0	16	771-2.0	■	■	■	781-2.0	■	■	■
2.5	16	771-2.5	■	■	■	781-2.5	■	■	■
3.0	16	771-3.0	■	■	■	781-3.0	■	■	■
3.5	16	771-3.5	■	■	■	781-3.5	■	■	■

Tronçonnage

Abstechen

Parting off

771XF / 781XF

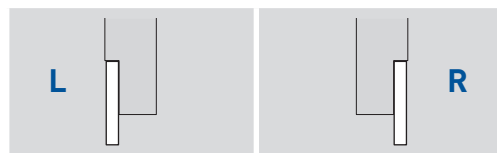
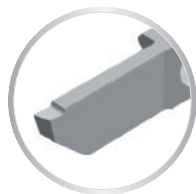
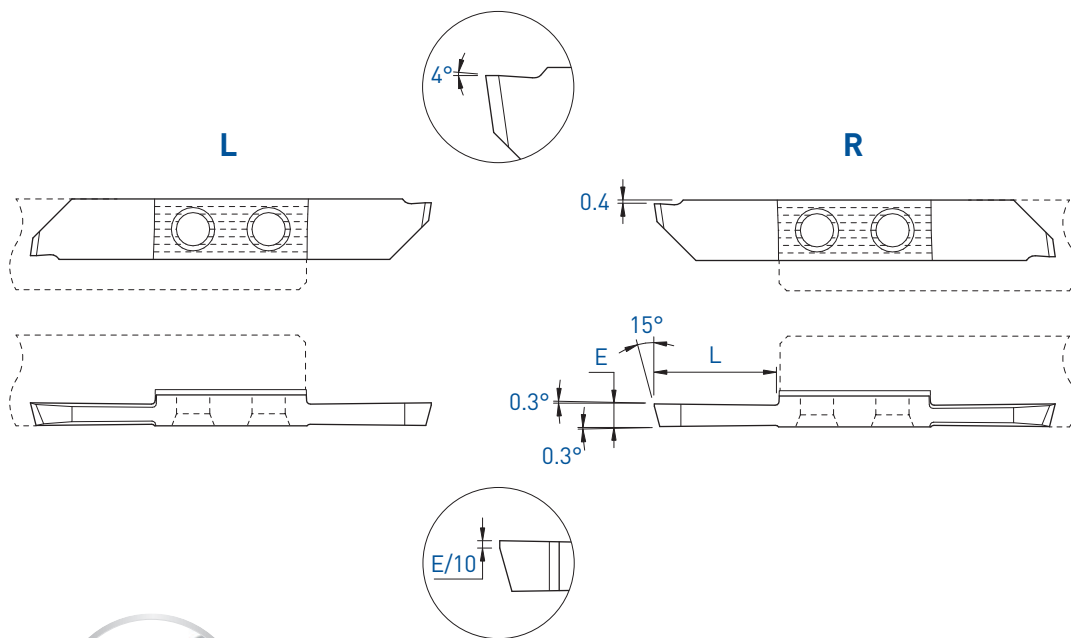

E	L	L			R				
		Art. N°	TiAlN	TiN	N (µk20)	Art. N°	TiAlN	TiN	N (µk20)
2.0	16	-				781XF-2.0	■	■	■
2.5	16	771XF-2.5	■	■	■	781XF-2.5	■	■	■
3.0	16	771XF-3.0	■	■	■	781XF-3.0	■	■	■
3.5	16	771XF-3.5	■	■	■	781XF-3.5	■	■	■

Tronçonnage

Abstechen

Parting off

Coupe déportée

Versetztes Schneiden

Cut off line

781L / 771R

Cut R

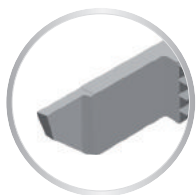
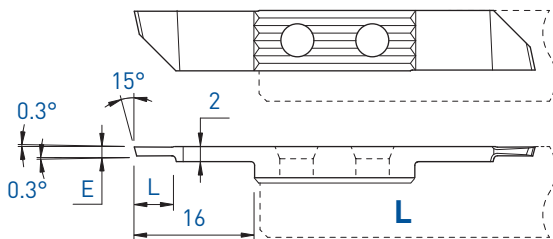

L (R)

Coupe à droite déportée
Versetztes Rechtsschneiden
Right cut off line

E	L	Art. N°	TiAlN	TiN	N (µk20)
1.0	5	771R-1.0	■	■	■
1.2	5	771R-1.2	■	■	■
1.5	8.5	771R-1.5	■	■	■

Cut L

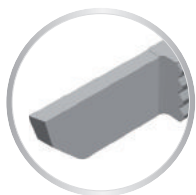
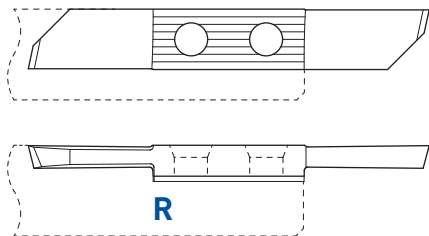

Cut R

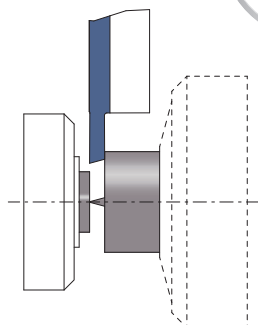
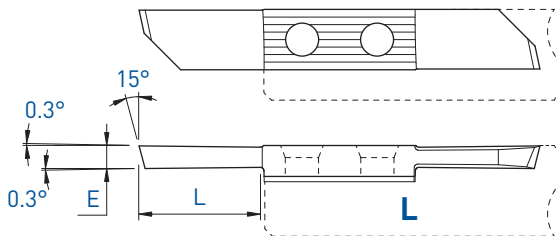

R (L)

Coupe à gauche déportée
Versetztes Linksschneiden
Left cut off line

L (R)

Coupe à droite déportée
Versetztes Rechtsschneiden
Right cut off line

E	L	Art. N°	TiAlN	TiN	N (µk20)	Art. N°	TiAlN	TiN	N (µk20)
2.0	16	781L-2.0	■	■	■	771R-2.0	■	■	■
2.5	16	781L-2.5	■	■	■	771R-2.5	■	■	■
3.0	16	781L-3.0	■	■	■	771R-3.0	■	■	■
3.5	16	781L-3.5	■	■	■	771R-3.5	■	■	■

Tronçonnage

Abstechen

Parting off

Coupe déportée

Versetztes Schneiden

Cut off line

771RU

Cut R

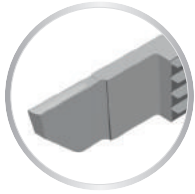
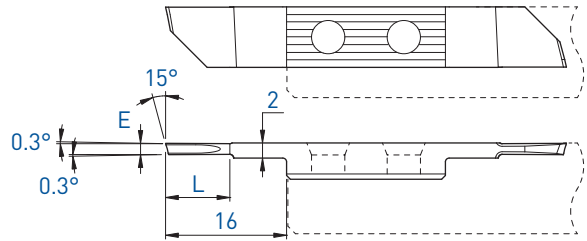

L (R)

Coupe à droite déportée
Versetztes Rechtsschneiden
Right cut off line

E	L	Art. N°	TiAlN	TiN	N (µk20)
1.0	5	771RU-1.0	■	□	■
1.5	8.5	771RU-1.5	■	□	■

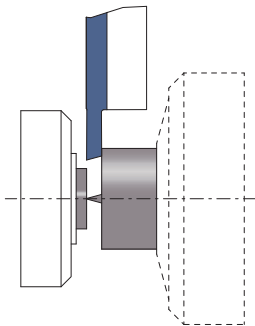

■ = disponible / verfügbar / available

□ = selon disponibilité du stock / jenach Lagerverfügbarkeit / depending on stock availability

TOP-LINE

Tronçonnage
Abstechen
Parting off

Coupe déportée
Versetztes Schneiden
Cut off line

781LXF / 771RXF

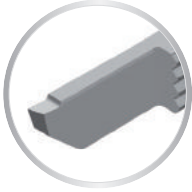
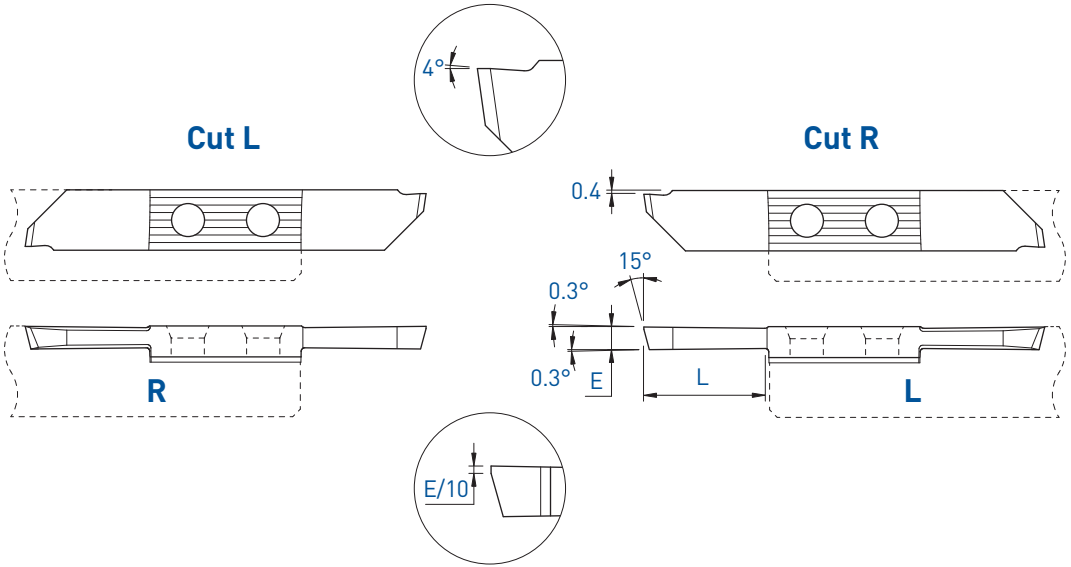

R (L)				L (R)			
Coupe à gauche déportée Versetztes Linksschneiden Left cut off line				Coupe à droite déportée Versetztes Rechtsschneiden Right cut off line			

E	L	Art. N°	TiAlN	TiN	N (µk20)	Art. N°	TiAlN	TiN	N (µk20)
2.0	16	-				771RXF-2.0	■	■	■
2.5	16	781LXF-2.5	■	■	■	771RXF-2.5	■	■	■
3.0	16	781LXF-3.0	■	■	■	771RXF-3.0	■	■	■
3.5	16	781LXF-3.5	■	■	■	771RXF-3.5	■	■	■

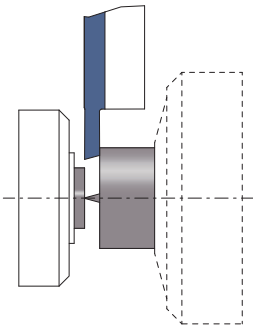

Tronçonnage

Abstechen

Parting off

Coupe déportée

Versetzttes Schneiden

Cut off line

771RD

Cut R

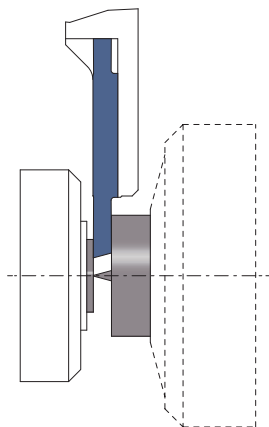
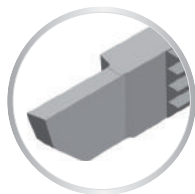
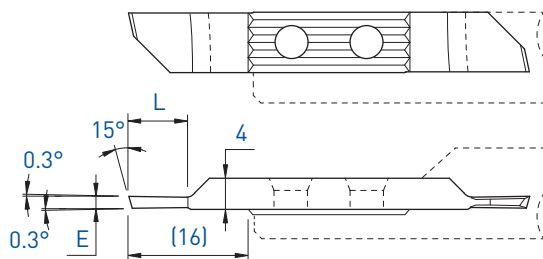

L (R)

Coupe à droite déportée
Versetzttes Rechtsschneiden
Right cut off line

E	L	Art. N°	TiAlN	TiN	N (µk20)
1.2	5	771RD-1.2	■	■	■
1.5	7.5	771RD-1.5	■	■	■
2.0	10	771RD-2.0	■	■	■

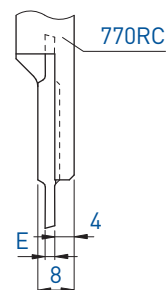

■ = disponible / verfügbar / available

□ = selon disponibilité du stock / jenach Lagerverfügbarkeit / depending on stock availability

L

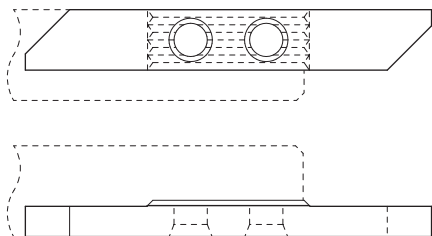

R

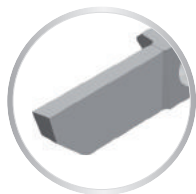
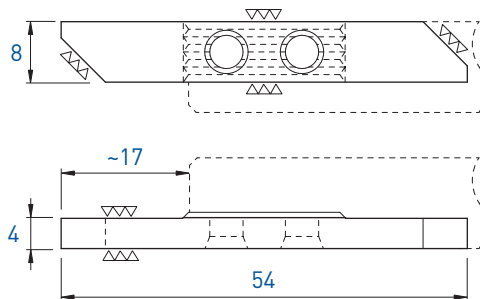

L		R	
Art. N°	N (µk20)	Art. N°	N (µk20)
771-E	■	781-E	■

Porte-outils

Halter

Holders

7050 / 7060

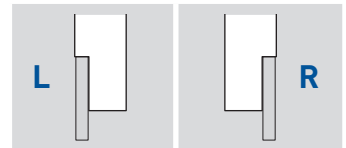
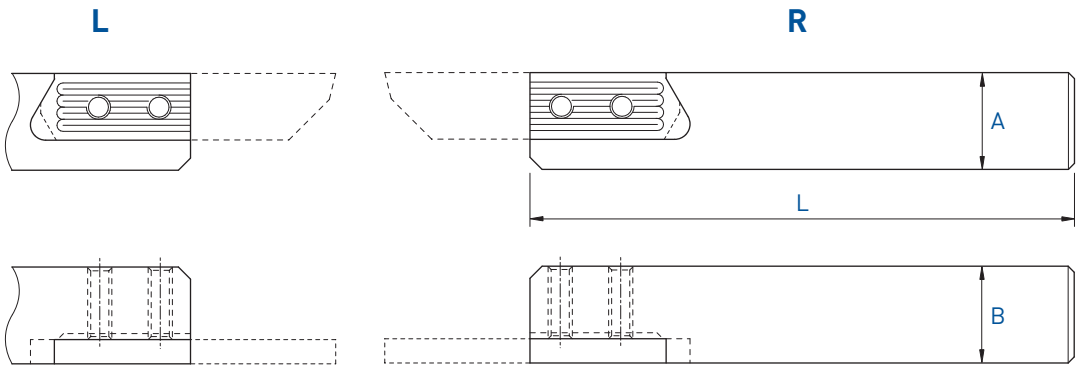

A x B	L	Serrage Spannsystem Clamping	Art. N°	Art. N°
16 x 16	130	A	7050-16	7060-16
16 x 16	75	A	7050-16-75	7060-16-75
20 x 20	120	A	7050-20	7060-20
25 x 25	140	A	7050-25	7060-25



Chaque support est livré avec vis et clé.
Jeder Halter wird mit Spannschraube(n) und Schlüssel geliefert.
Screw(s) and key are included with each tool holder.

■ = disponible / verfügbar / available

□ = selon disponibilité du stock / jenach Lagerverfügbarkeit / depending on stock availability

Tronçonnage

Abstechen

Parting off

7051 / 7061

L

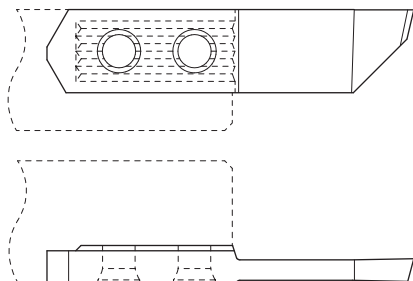

R

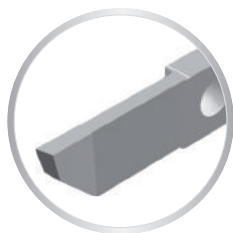
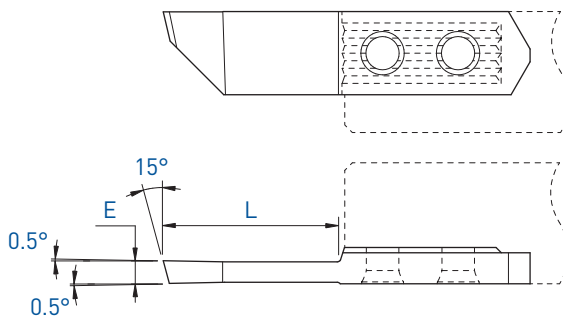

L

R

E	L	L			R				
		Art. N°	TiAlN	TiN	N [µk20]	Art. N°	TiAlN	TiN	N [µk20]
2.5	22	-				7061-2.5	■	■	■
3.0	22	7051-3.0	■	■	■	7061-3.0	■	■	■
3.5	22	-				7061-3.5	■	■	■

Tronçonnage

Abstechen

Parting off

7051XF / 7061XF

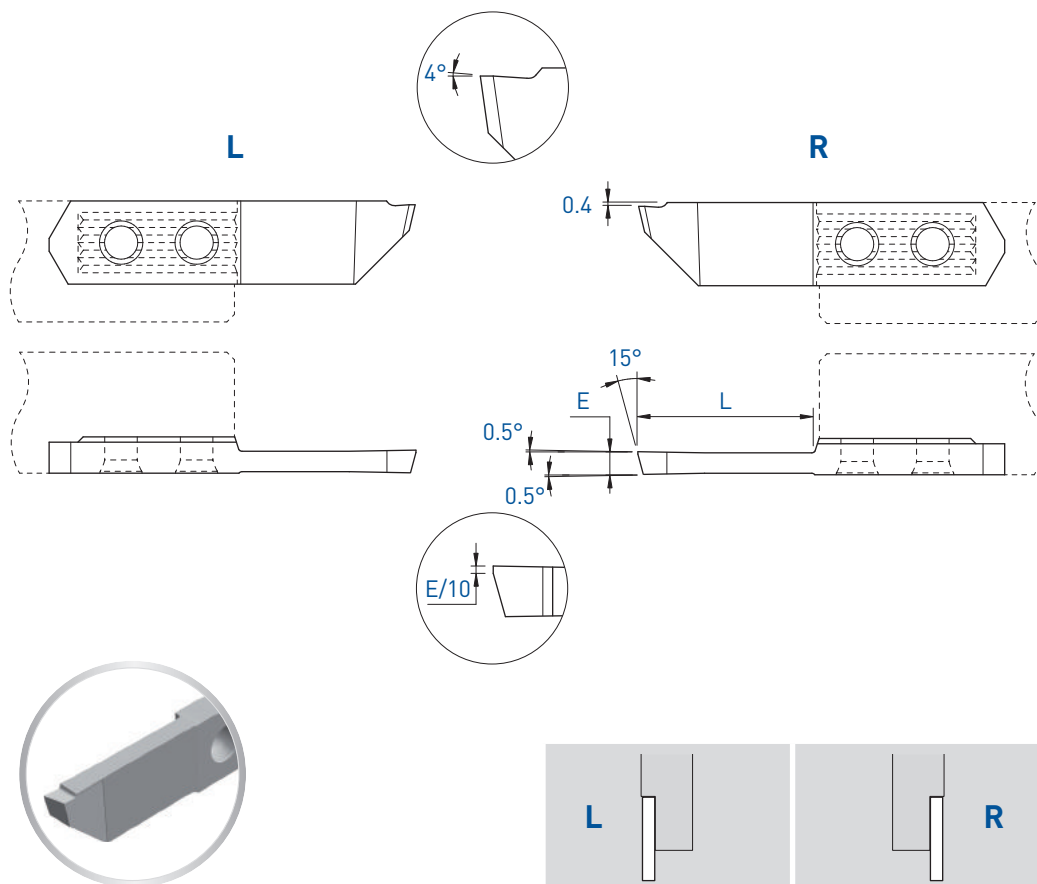

		L			R				
E	L	Art. N°	TiAlN	TiN	N [µk20]	Art. N°	TiAlN	TiN	N [µk20]
3.0	22	7051XF-3.0	■	■	■	7061XF-3.0	■	■	■

Tronçonnage

Abstechen

Parting off

Coupe déportée

Versetztes Schneiden

Cut off line

7061L / 7051R

Cut L

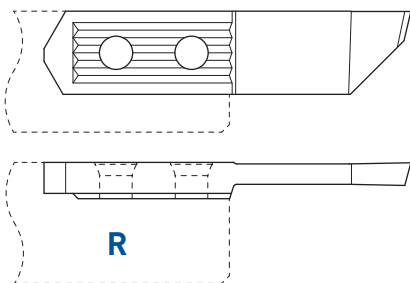

Cut R

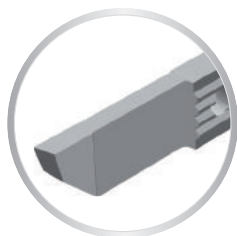
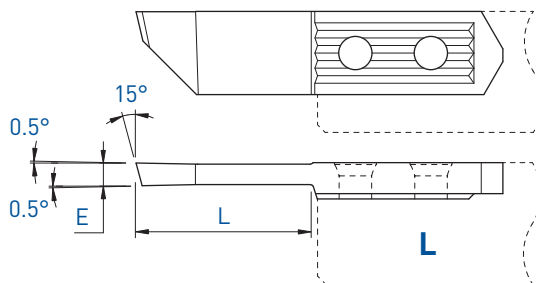

R (L)

Coupe à gauche déportée
Versetztes Linksschneiden
Left cut off line

L (R)

Coupe à droite déportée
Versetztes Rechtsschneiden
Right cut off line

E	L	Art. N°	TiAIN	TiN	N (µk20)	Art. N°	TiAIN	TiN	N (µk20)
2.5	22	-				7051R-2.5	■	■	■
3.0	22	7061L-3.0	■	■	■	7051R-3.0	■	■	■
3.5	22	-				7051R-3.5	■	■	■

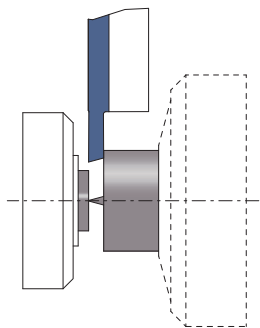

Tronçonnage
Abstechen
Parting off

Coupe déportée
Versetztes Schneiden
Cut off line

7061LXF / 7051RXF

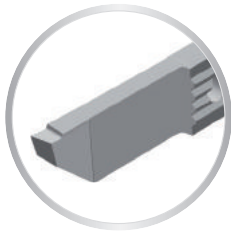
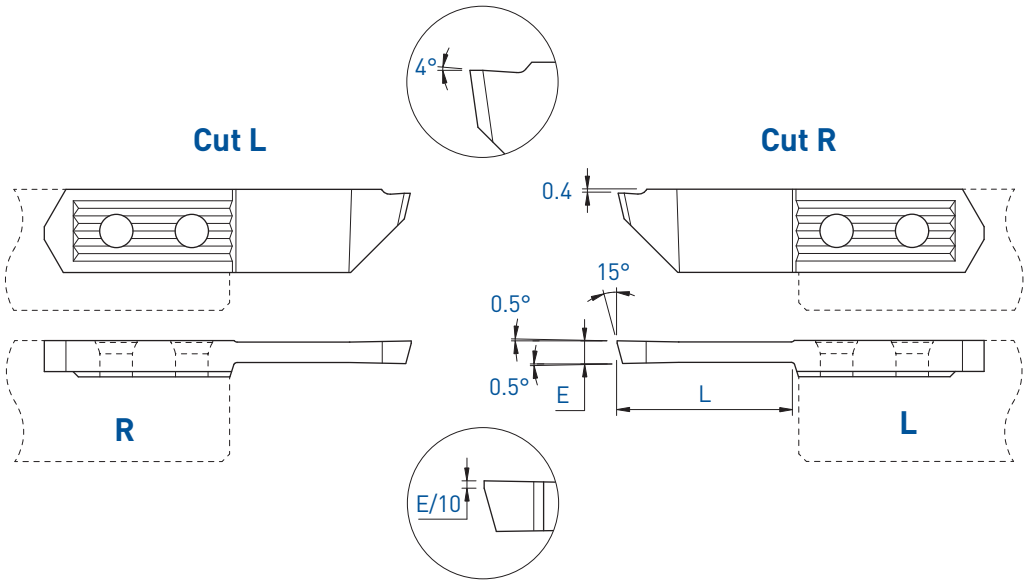

R (L)	L (R)
Coupe à gauche déportée Versetztes Linksschneiden Left cut off line	Coupe à droite déportée Versetztes Rechtsschneiden Right cut off line

E	L	Art. N°	TiAIN	TiN	N (µk20)	Art. N°	TiAIN	TiN	N (µk20)
3.0	22	7061LXF-3.0	■	■	■	7051RXF-3.0	■	■	■

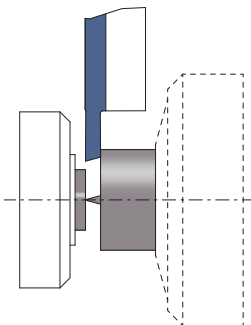

L

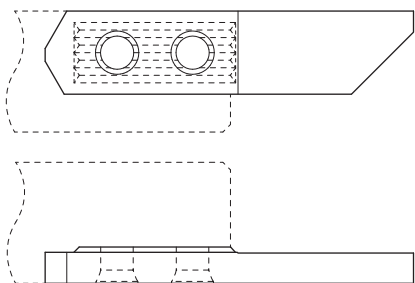

R

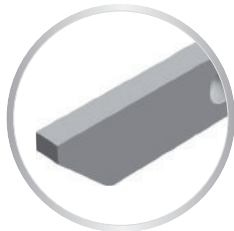
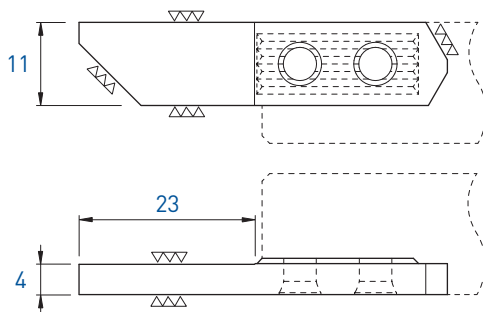

L		R	
Art. N°	N (µk20)	Art. N°	N (µk20)
7051-E	■	7061-E	■

Porte-outils

Halter

Holder

W750 / W760

L

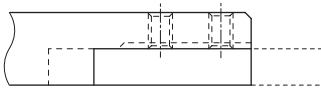
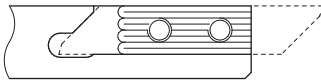

R

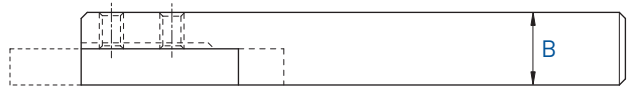
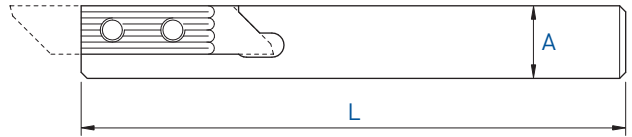

L

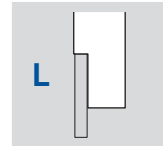

R

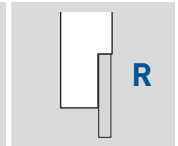

A x B	L	Serrage Spannsystem Clamping	Art. N°	Art. N°
12 x 12	130	A	W750-12	W760-12
16 x 16	130	A	W750-16	W760-16
20 x 20	120	A	W750-20	W760-20



Chaque support est livré avec vis et clé.
Jeder Halter wird mit Spannschraube(n) und Schlüssel geliefert.
Screw(s) and key are included with each tool holder.

■ = disponible / verfügbar / available

□ = selon disponibilité du stock / jenach Lagerverfügbarkeit / depending on stock availability

TOP-LINE

Porte-outils avec arrosage intégré
 Halter mit integrierter Kühlmittelzufuhr
 Holders with integrated coolant supply

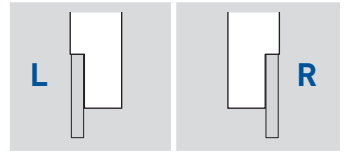
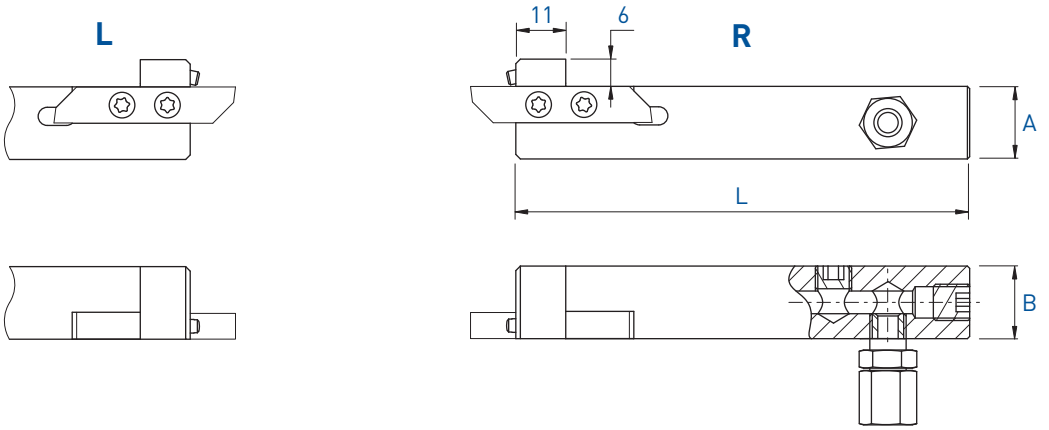

W750-JET / W760-JET

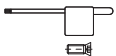

A x B	L	Serrage Spannsystem Clamping	Art. N°	Art. N°
16 x 16	100	A	W750-16-JET	W760-16-JET
20 x 20	100	A	W750-20-JET	W760-20-JET

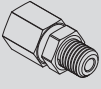

Chaque support est livré avec vis et clé.
 Jeder Halter wird mit Spannschraube(n)
 und Schlüssel geliefert.
 Screw(s) and key are included with each
 tool holder.

Pièces de rechange Ersatzteile Spare parts			Buse Düse Nozzle 
	Art. N°	Art. N°	Art. N°
W750-JET / W760-JET	J-M8X1-D6	JB-M8X1	JJ-M3X6-D1.5

Plaquettes ébauches

WSP-Rohlinge

Blank inserts

W751-E5 / W761-E5
W751-EP5 / W761-EP5

L

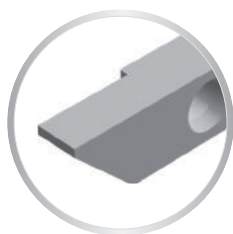
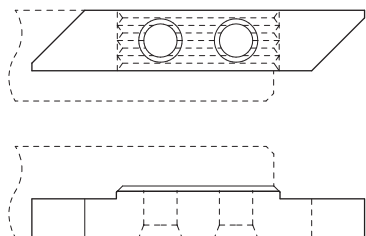

R

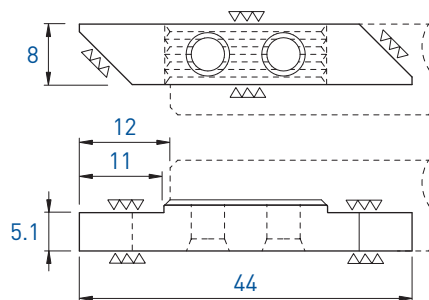

L		R	
Art. N°	N (µk20)	Art. N°	N (µk20)
W751-E5	■	W761-E5	■

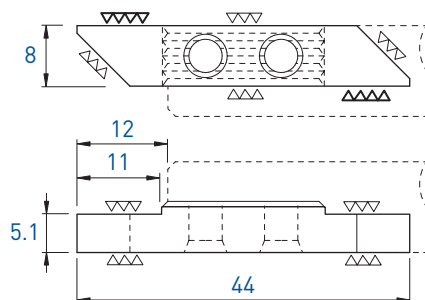
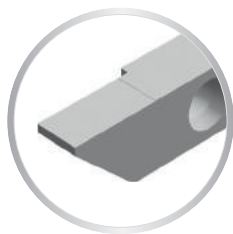
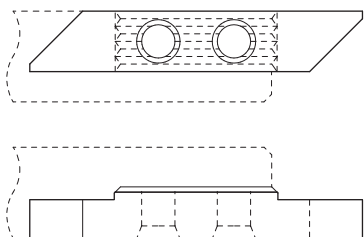

L		R	
Art. N°	N (µk20)	Art. N°	N (µk20)
W751-EP5	■	W761-EP5	■

■ = disponible / verfügbar / available

□ = selon disponibilité du stock / jenach Lagerverfügbarkeit / depending on stock availability

Plaquettes ébauches

WSP-Rohlinge

Blank inserts

W751-E6 / W761-E6 W751-EP6 / W761-EP6

L

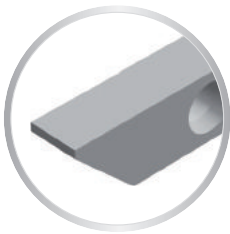
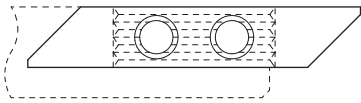

R

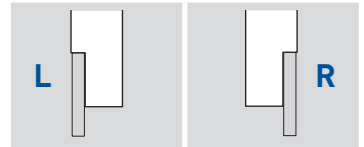
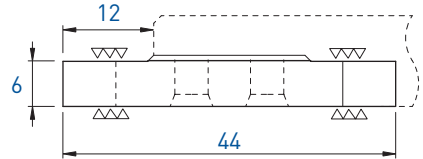
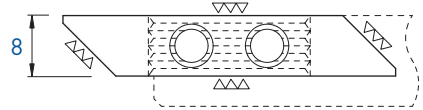

Art. N°	N (µk20)	Art. N°	N (µk20)
W751-E6	■	W761-E6	■

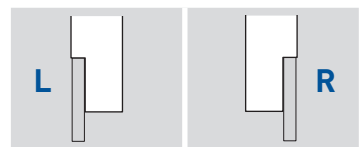
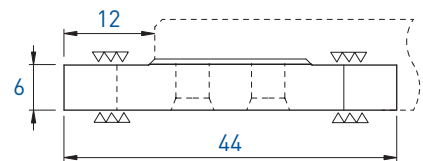
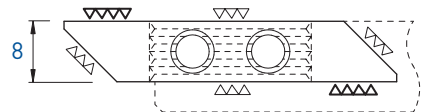
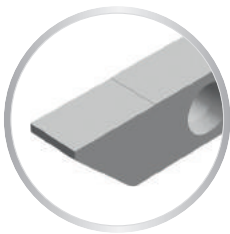
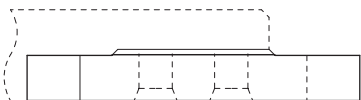
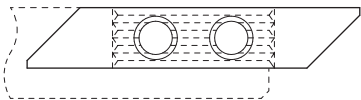

Art. N°	N (µk20)	Art. N°	N (µk20)
W751-EP6	■	W761-EP6	■

Interface polygonale PSC
 Polygonal Schnittstelle PSC
 Polygonal interface PSC

R

C3 / C4

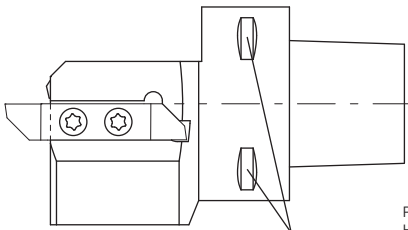
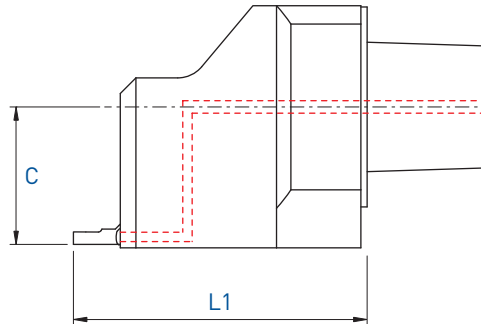
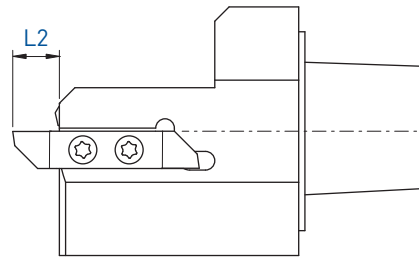
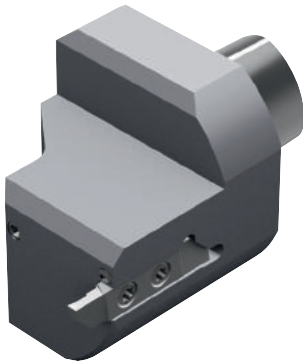

Porte-outils pour changeur automatique sur demande.
 Halter für Werkzeugwechsler auf Anfrage.
 Holders for tool changer on request.

Type	Plaquettes type WSP Typ Insert type	Pages Seiten Pages	L1	C	L2	Art. N°	Buse Düse Nozzle
							Art. N°
C3	740	> 1.32	47	22	7.5	C3-740-22047	JJ-M3X6-D1.5
C3	760	> 1.78	47	22	10	C3-760-22047	JJ-M3X6-D1.5
C4	760	> 1.78	62	27	10	C4-760-27062	JJ-M3X6-D1.5

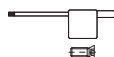

Chaque support est livré avec vis et clé.
 Jeder Halter wird mit Spannschraube(n) und Schlüssel geliefert.
 Screw(s) and key are included with each tool holder.

■ = disponible / verfügbar / available
 □ = selon disponibilité du stock / jenach Lagerverfügbarkeit / depending on stock availability

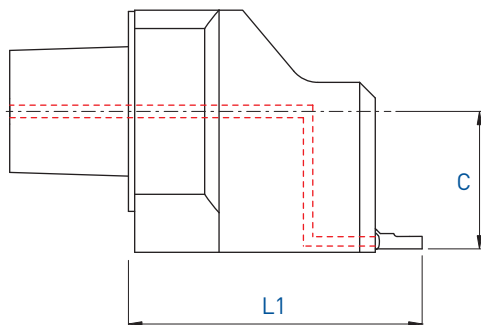
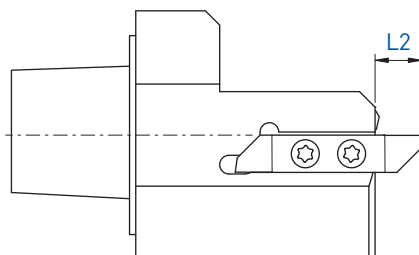
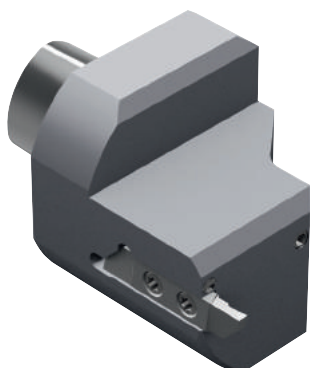

Type	Plaquettes type WSP Typ Insert type	Pages Seiten Pages	L1	C	L2	Art. N°	Buse Düse Nozzle Art. N°
C4	750	> 1.78	62	27	10	C4-750-27062	JJ-M3X6-D1.5

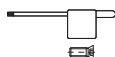

Chaque support est livré avec vis et clé.
 Jeder Halter wird mit Spannschraube(n) und Schlüssel geliefert.
 Screw(s) and key are included with each tool holder.

Porte-outils

Halter

Holders

HSK

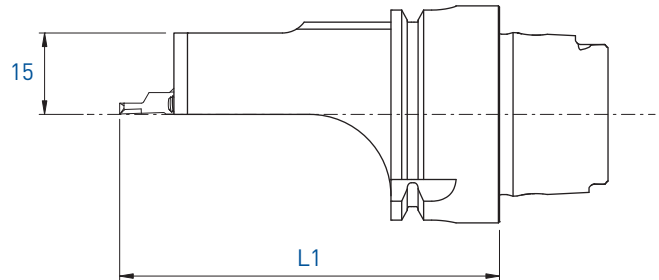
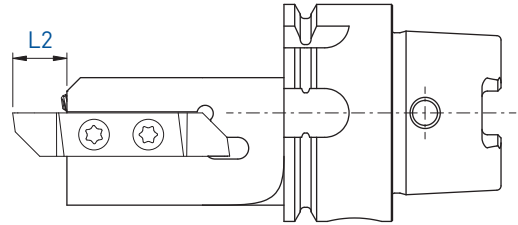

Utilisable sur toutes les machines avec broches HSK-T ou HSK-A

Auf allen Maschinen mit HSK-T oder HSK-A verwendbar

Applicable on all machines with HSK-T or HSK-A spindle

Plaquettes type WSP Typ Insert type	Pages Seiten Pages	L1	L2	Art. N°	Buse Düse Nozzle
					Art. N°
740	> 1.32	65	7.5	HSK-T40-740-0065-JET HSK-A40-S191-740-0065-JET*	JJ-M3X6-D1.5
760	> 1.78	70	10	HSK-T40-760-0070-JET HSK-A40-S191-760-0070-JET*	JJ-M3X6-D1.5

* pour machines Bumotec
für Bumotec Maschinen
for Bumotec machines



Chaque support est livré avec vis et clé.
Jeder Halter wird mit Spannschraube(n) und Schlüssel geliefert.
Screw(s) and key are included with each tool holder.

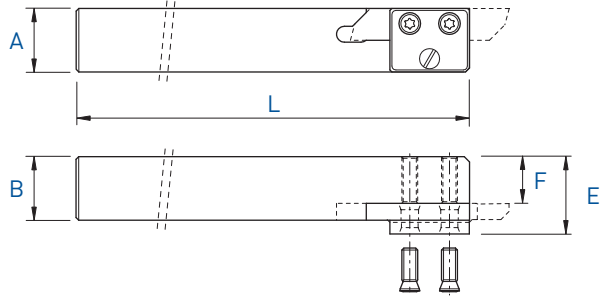
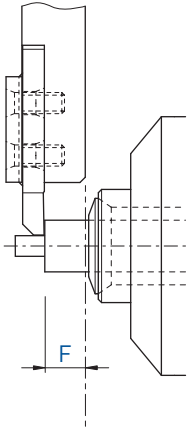

740 Series

A x B	L	F	E	Art. N°	Plaquettes type WSP Typ Inserts type	Pages Seiten Pages
12 x 12	130	9.5	14.5	740Z-12	741 - 747	> 1.32
16 x 16	130	13.5	18.5	740Z-16	741 - 747	> 1.32

760 Series

A x B	L	F	E	Art. N°	Plaquettes type WSP Typ Inserts type	Pages Seiten Pages
12 x 12	130	8	15	760Z-12	761 - 767	> 1.78
16 x 16	130	12	19	760Z-16	761 - 767	> 1.78

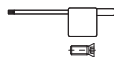

Chaque support est livré avec vis et clé.
 Jeder Halter wird mit Spannschraube(n) und Schlüssel geliefert.
 Screw(s) and key are included with each tool holder.

Porte-outils pour machine Tornos

Halter für Tornos Maschine

Holders for Tornos machine

R

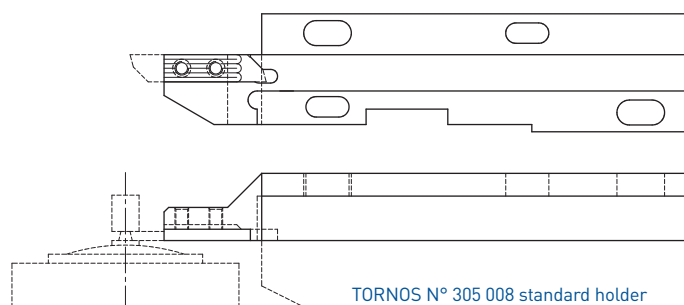
DECO 7/10
EvoDECO 10Coupe à droite
Rechtsschneiden
Right hand cut

Art. N°	Plaquettes type WSP Typ Inserts type	Pages Seiten Pages
740-DECO10	741 - 747	> 1.32

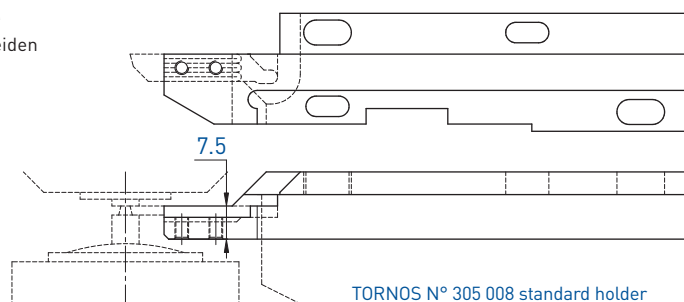
Coupe à droite déportée
Versetztes Rechtsschneiden
Right cut off line

Art. N°	Plaquettes type WSP Typ Inserts type	Pages Seiten Pages
730R-DECO10	731R / 731N	1.39 - 1.45

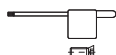

Chaque support est livré avec vis et clé.
Jeder Halter wird mit Spannschraube(n) und Schlüssel geliefert.
Screw(s) and key are included with each tool holder.

Porte-outils pour machine Tornos
 Halter für Tornos Maschine
 Holders for Tornos machine

R

DECO 7/10
 EvoDECO 10

Pour le tronçonnage de petites pièces
 Zum Abstechen von kleinen Werkstücken
 For small parts parting off



Réglable en longueur
 Längseinstellbar
 Adjustable length

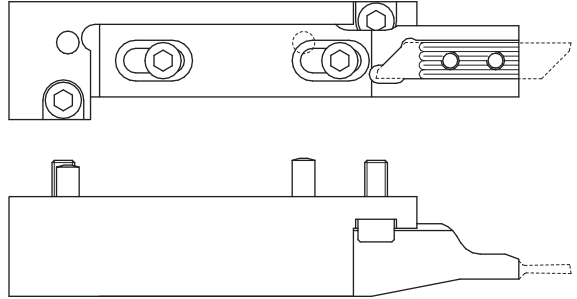

Art. N°	Plaquettes type WSP Typ Inserts type	Pages Seiten Pages
750R-DECO10	751R / 751N	1.88 - 1.99

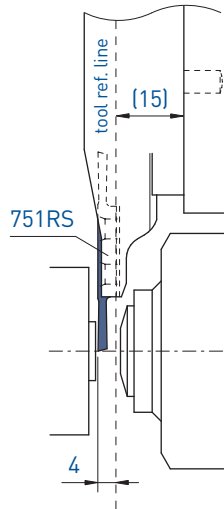
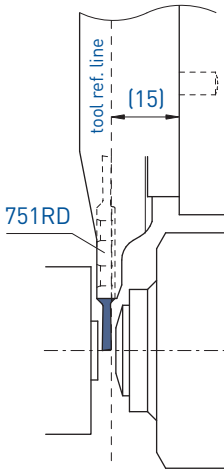

Chaque support est livré avec vis et clé.
 Jeder Halter wird mit Spannschraubel(n) und Schlüssel geliefert.
 Screw(s) and key are included with each tool holder.

Porte-outils pour machine Tornos

Halter für Tornos Maschine

Holders for Tornos machine

L

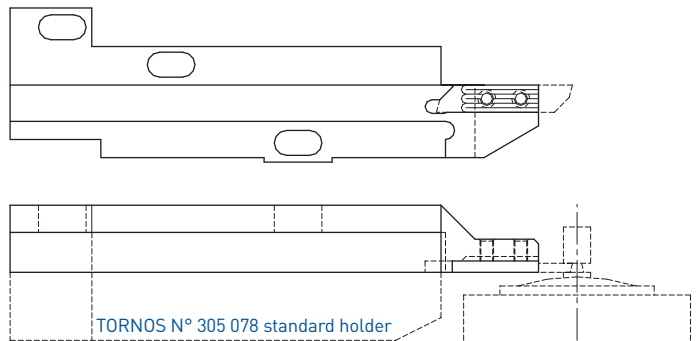
DECO 7/10
EvoDECO 10Coupe à gauche
Linksschneiden
Left hand cut

Art. N°	Plaquettes type WSP Typ Inserts type	Pages Seiten Pages
730-DECO10	731 - 737	> 1.32

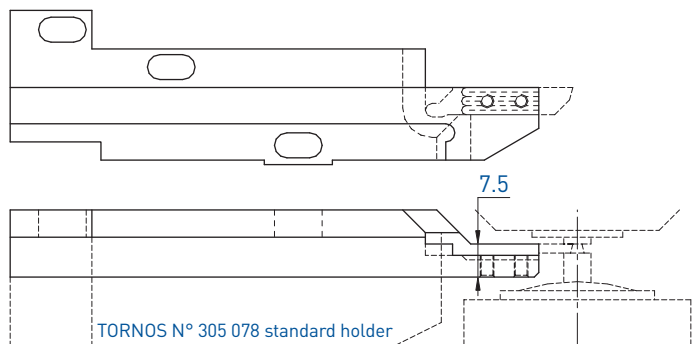
Coupe à gauche déportée
Versetztes Linksschneiden
Left cut off line

Art. N°	Plaquettes type WSP Typ Inserts type	Pages Seiten Pages
740L-DECO10	741L / 741N	1.39 - 1.45

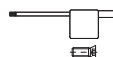

Chaque support est livré avec vis et clé.
Jeder Halter wird mit Spannschraub(en) und Schlüssel geliefert.
Screw(s) and key are included with each tool holder.

Porte-outils pour machine Tornos

Halter für Tornos Maschine

Holders for Tornos machine

L

DECO 7/10
EvoDECO 10

Pour le tronçonnage de petites pièces
Zum Abstechen von kleinen Werkstücken
For small parts parting off



Réglable en longueur
Längseinstellbar
Adjustable length

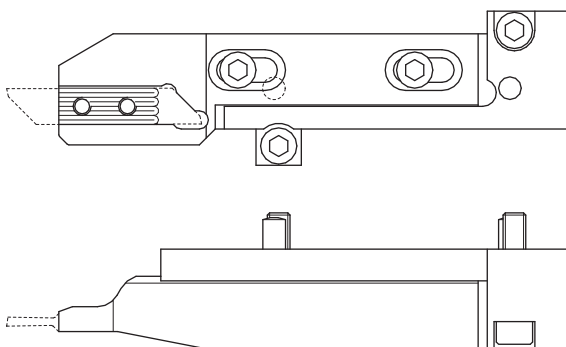

Art. N°	Plaquettes type WSP Typ Inserts type	Pages Seiten Pages
760L-DECO10	761L / 761N	1.88 - 1.98

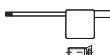
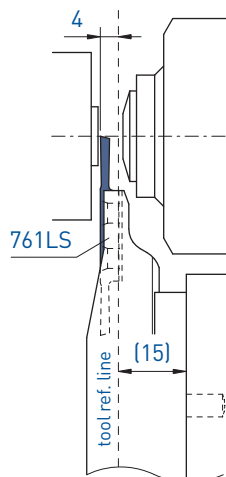
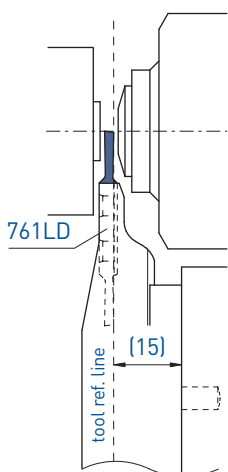

Chaque support est livré avec vis et clé.
Jeder Halter wird mit Spannschraube(n) und Schlüssel geliefert.
Screw(s) and key are included with each tool holder.

Porte-outils pour machine Tornos

Halter für Tornos Maschine

Holders for Tornos machine

DECO 13
EvoDECO 16

Pour le tronçonnage de petites pièces
Zum Abstechen von kleinen Werkstücken
For small parts parting off

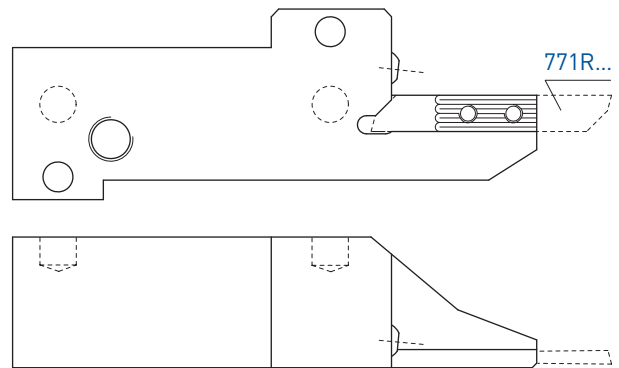

Art. N°	Plaquettes type WSP Typ Inserts type	Pages Seiten Pages
770R-DECO13	771R	1.138 - 1.141

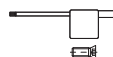
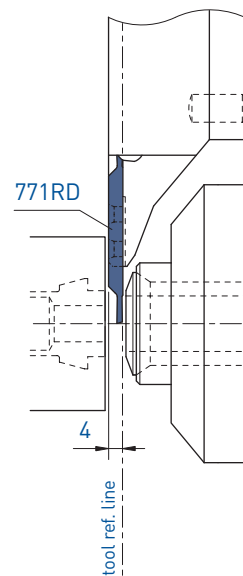
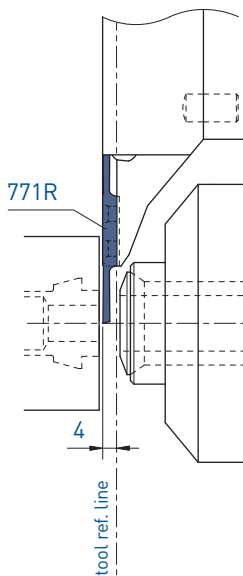

Chaque support est livré avec vis et clé.
Jeder Halter wird mit Spannschraube(n) und Schlüssel geliefert.
Screw(s) and key are included with each tool holder.

Porte-outils pour machine Tornos

Halter für Tornos Maschine

Holders for Tornos machine

DECO 20
EvoDECO 20/32

Pour le tronçonnage de petites pièces
Zum Abstechen von kleinen Werkstücken
For small parts parting off

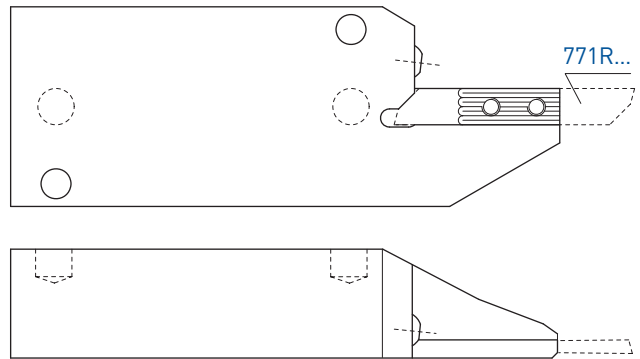

Art. N°	Plaquettes type WSP Typ Inserts type	Pages Seiten Pages
770R-DECO20	771R	1.138 - 1.141

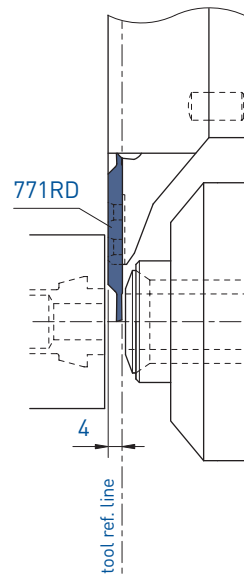
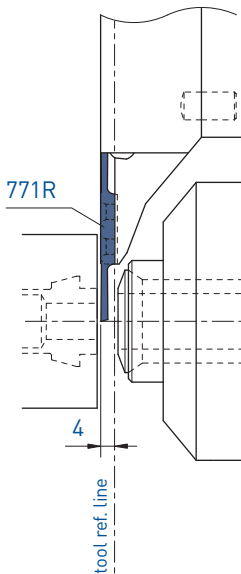

Chaque support est livré avec vis et clé.
Jeder Halter wird mit Spannschraube(n) und Schlüssel geliefert.
Screw(s) and key are included with each tool holder.

Porte-outils pour machine Tornos

Halter für Tornos Maschine

Holders for Tornos machine

MultiSwiss 6x16

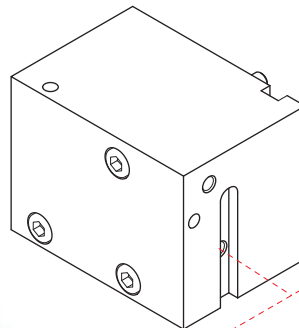
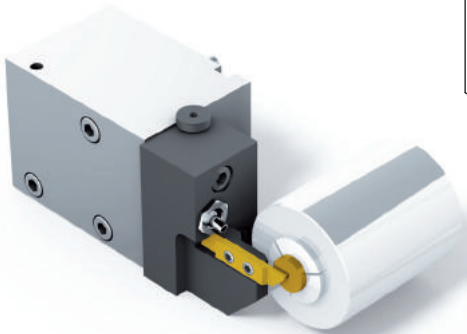
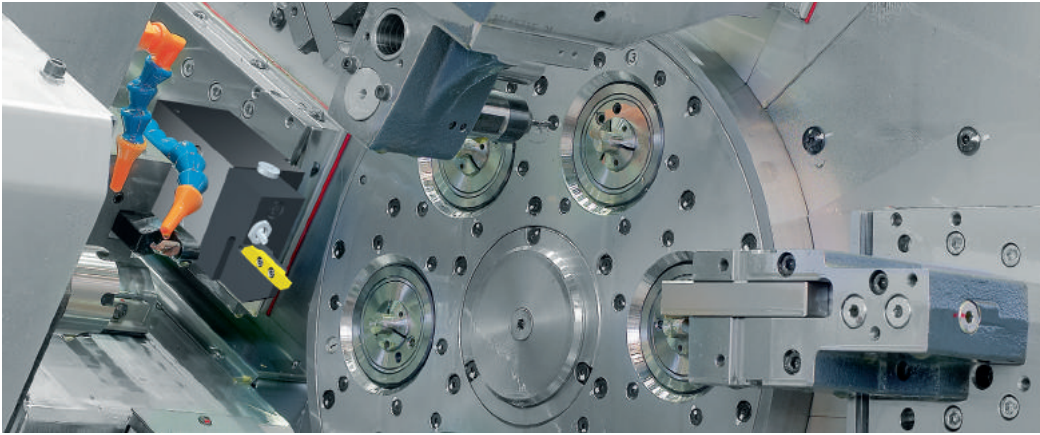

750R-MULTISWISS

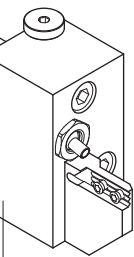
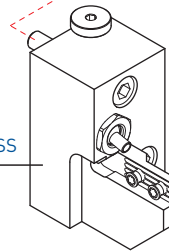

730R-MULTISWISS

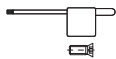

Chaque support est livré avec vis et clé.
Jeder Halter wird mit Spannschraube(n) und Schlüssel geliefert.
Screw(s) and key are included with each tool holder.

Art. N°	Plaquettes type WSP Typ Inserts type	Pages Seiten Pages
730R-MULTISWISS	731R / 731N	1.39 - 1.45
750R-MULTISWISS	751R / 751N	1.88 - 1.99

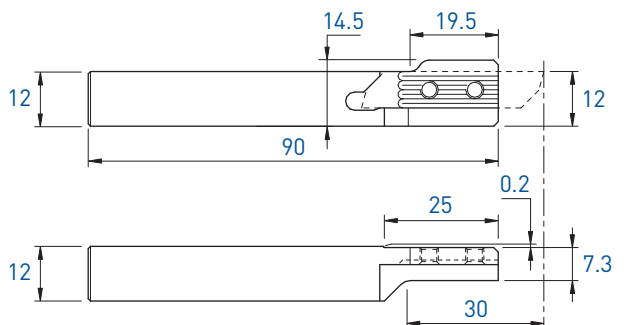

Art. N°	Plaquettes type WSP Typ Inserts type	Pages Seiten Pages
750RAS-12	751R	1.88 - 1.96

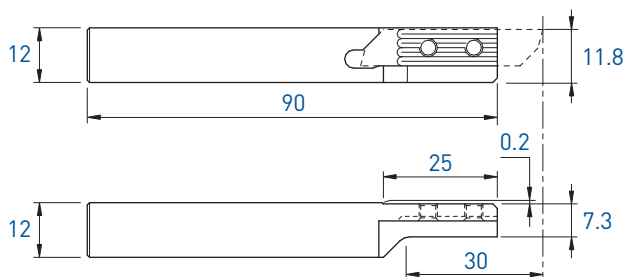

Art. N°	Plaquettes type WSP Typ Inserts type	Pages Seiten Pages
750RAS-12-H11.8	751R	1.88 - 1.96

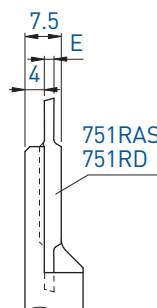
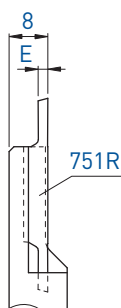
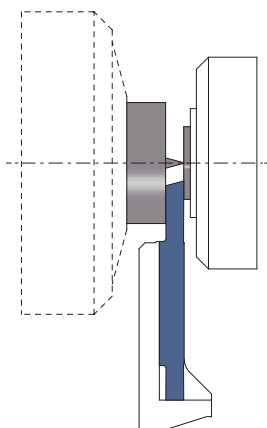

(p. 1.98 - 1.99)

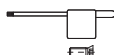

Chaque support est livré avec vis et clé.
Jeder Halter wird mit Spannschraube(n) und Schlüssel geliefert.
Screw(s) and key are included with each tool holder.

Porte-outils

Halter

Holder

Schütze

DT20

DT30

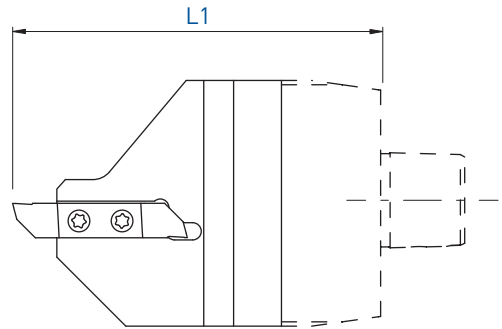

Compatibility Schütze

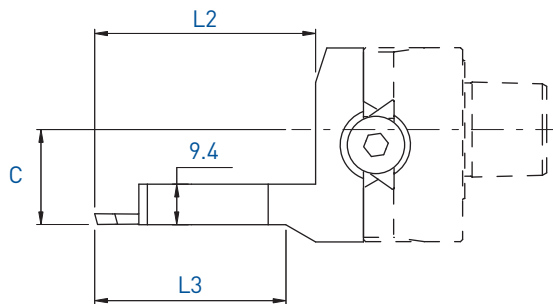
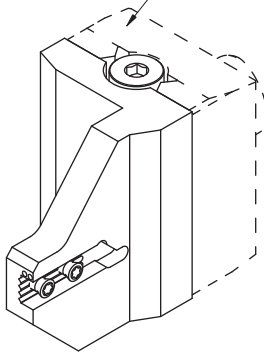

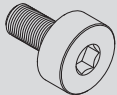

Plaquettes type WSP Typ Inserts type	Pages Seiten Pages	L1	C	L2	L3	Art. N°	Compatibility Schütze	
								Art. N°
761-767	> 1.78	86	22	51	44	DT20-760-JET	C3-75870949	V-M6X0.5-14-L18
		83	27.5	48	-	DT30-760-JET	C4-75836783	

Vis et clés de rechange

Ersatzschrauben und Schlüssel

Spare screws and keys

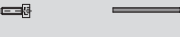
	Porte-outils Halter Holders	Serrage standard (A) Standard Spannsystem (A) Standard clamping system (A) 	Serrage type B Spannsystem Typ B Clamping system type B 	
710	710-6 / - NOVIBRA	V-M2.5X5.8-T8	-	
	710-7 / - NOVIBRA	V-M2.5X6.5-T8		
	710-8 / - NOVIBRA	C-T8		
	710-10 - 710-12			V-M2.5X7.8-T8
720	720-7	V-M2.5X6.5-T8	-	
	720-8 - 720-12	V-M2.5X7.8-T8		
730	730-7 / - JET / -NOVIBRA	V-M3X7-T8	-	
	730-8 / -NOVIBRA		V-M2.5X7.8-T8	
	730-10 - 730-20		C-T8	
	730-DECO10		-	
	730R-DECO10		-	
730RC	V-M3X5.5-T8	-		
740	740-7 / -JET / -NOVIBRA	V-M3X7-T8	-	
	740-8 / -NOVIBRA -		V-M2.5X7.8-T8	
	740-12 / -JET / -NOVIBRA		C-T8	
	740-16 - 740-20		C-T8	
	740/730-D			
	740-C			V-M3X5.5-T8
	740-DECO10			-
740L-DECO10	-			
740-Z	V-M3X9-T8			
	Porte-outils Halter Holders	Serrage standard (A) Standard Spannsystem (A) Standard clamping system (A) 	Serrage type B Spannsystem Typ B Clamping system type B 	
750	750-10 - 750-12 / -JET	V-M4X9-T15	-	
	750-10-AB		V-M3X10-BN11	
	750-12-AB		V-M3X8-BN11	
	750-12.7 - 750-14		V-M3X10-BN11	
	750-16		V-M3X12-BN11	
	750-20		V-M3X16-BN11	
	750RAS - 750-RC		V-M4X7.3-T15	
750R-DECO10	V-M4X5.6-T15	-		
760	760-10 - 760-12 / -JET / -NOVIBRA /	V-M4X9-T15	-	
	760/750		V-M3X10-BN21	
	760-10-AB		V-M3X8-BN11	
	760-12-AB		V-M3X10-BN11	
	760-12.7 - 760-14		V-M3X12-BN11	
	760-16		V-M3X16-BN11	
	760-20		-	
	760LC		V-M4X7.3-T15	
760L-DECO10	V-M4X5.6-T15	-		
760-Z	V-M4X12-T15	-		

Vis et clés de rechange

Ersatzschrauben und Schlüssel

Spare screws and keys

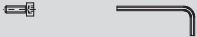
	Porte-outils Halter Holders	Serrage standard (A) Standard Spannsystem (A) Standard clamping system (A) 		Serrage type B Spannsystem Typ B Clamping system type B 	
770	770 / -JET	V-M4X9-T15	C-T15	-	-
	770RC	V-M4X7.3-T15			
780	780 / -JET	V-M4X9-T15	C-T15	-	-
7050	7050	V-M4X9-T15	C-T15	-	-
7060	7060	V-M4X9-T15	C-T15	-	-
W	W750 / W760 / -JET	V-M4X11.5-T15	C-T15	-	-
C3	C3-740	V-M3X7-T8	C-T8	-	-
	C3-760	V-M4X9-T15	C-T15		
C4	C4-750	V-M4X9-T15	C-T15	-	-
	C4-760				
HSK	HSK-T40-740	V-M3X7-T8	C-T8	-	-
	HSK-T40-760	V-M4X9-T15	C-T15		
MultiSwiss	730R-MULTISWISS	V-M3X5.5-T8	C-T8	-	-
	750R-MULTISWISS	V-M4X7.3-T15	C-T15		
Schütte	DT20-760-JET	V-M4X9-T15	C-T15	-	-
	DT30-760-JET				

Nuances micro-grain à dureté élevée
 Verschleissfeste Feinkornsorten
 Wear resistant micro-grain grades > **2.02**

Pièces de rechange
 Ersatzteile
 Spare parts > **2.05**

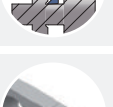
	pour machines à cames für kurvengesteuerte Maschinen for cam driven machines		pour machines CNC für CNC-Maschinen for CNC driven machines		
	L		L	R	
	710 710SF 710-NOVIBRA	> 2.06	730 730-NOVIBRA	740 740SF 740-NOVIBRA	> 2.10
	711SF	> 2.08		741SF	> 2.13
	712SF	> 2.08		742SF	> 2.13
	713SF	> 2.09		743SF	> 2.15
			736SF	746SF	> 2.17
				748SF	> 2.18
				749SF	> 2.18
	711-ESF	> 2.09	731-ESF	741-ESF	> 2.19

Coupe à droite déportée / Versetztes Rechtsschneiden / Right cut off line

**730RC
750RC**

> **2.20**



**731R
751R**

> **2.21**

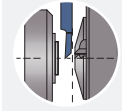

770-SN-SF

> **2.22** **new**



771RVSF

> **2.24** **new**

Halter für SwissNano
Porte-outils pour Swissnano - MODU-Line
Holder for SwissNano

ML12

> **2.24**

Nuances micro-grain à dureté élevée

Verschleissfeste Feinkornsorten

Wear resistant micro-grain grades

new

N (μ K20)

non revêtu
unbeschichtet
uncoated

- nuance micro-grain tenace, résistante aux conditions défavorables, recommandée pour des opérations de coupe dans des matières ne nécessitant aucun revêtement
- zähe Feinkornsorte, in ungünstige Bearbeitungs-konditionen widerstandsfähig, für Schnittbearbeitung empfohlen, die keine Beschichtung erfordern
- tough micro-grain grade, suitable for unfavorable machining conditions, suitable for cutting in material that do not necessitate any tool coating

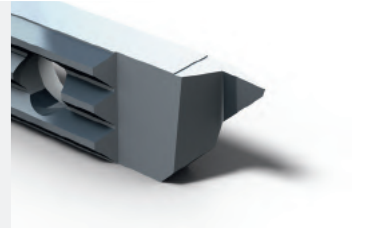

new

TAF

μ K20 + revêtement PVD
 μ K20 + PVD Beschichtung
 μ K20 + PVD coating

- nuance tenace résistante aux conditions défavorables, recommandée pour des opérations de coupes dans les aciers et aciers inoxydables.
- zähe widerstandsfähige Sorte in ungünstigen Bearbeitungskonditionen, für Schnittbearbeitung in Stahl und rostfreiem Stahl empfohlen
- tough grade, resistant to unfavorable machining conditions, suitable for cutting of steel and stainless steel

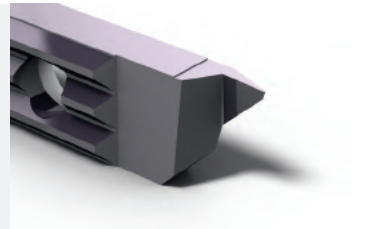

HN (μ K10)

non revêtu
unbeschichtet
uncoated

- nuance micro-grain, bonne résistance à l'usure, recommandée pour des opérations d'ébauche et de finition pour des matières ou usinages ne nécessitant aucun revêtement
- verschleissfeste Feinkornsorte, für Schruppen und Schlichtbearbeitung empfohlen oder für Werkstoffe oder Bearbeitungen, die keine Beschichtung erfordern
- wear resistant micro-grain carbide, recommended for roughing and finishing and for materials or operations that do not necessitate any tool coating

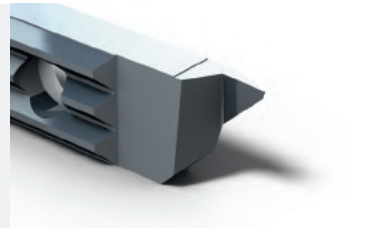

HTC

μ K10 + revêtement PVD
 μ K10 + PVD Beschichtung
 μ K10 + PVD coating

- nuance résistante à l'usure, faible coefficient de frottement, recommandée pour des opérations d'ébauche et de finition
- verschleissfeste Sorte, geringer Reibwert, für Schruppen und Schlichtbearbeitung empfohlen
- wear resistant grade, low friction ratio, recommended for roughing and finishing

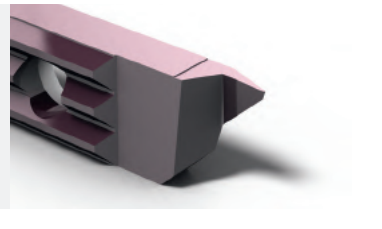

conseillée pour l'usinage de la matière 20AP
für Bearbeitung von 20AP geeignet
suitable for machining of 20AP material

HTC-RE

μ K10 + revêtement PVD
 μ K10 + PVD Beschichtung
 μ K10 + PVD coating

- nuance identique à HTC avec dépouilles rectifiées après revêtement pour des opérations de finition
- gleiche Sorte wie HTC nach der Beschichtung geschliffener Freiwinkel, für Schlichtbearbeitung empfohlen
- same grade as HTC, after coating grounded clearance, recommended for finishing

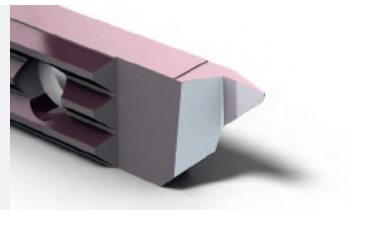

conseillée pour l'usinage de la matière 20AP
für Bearbeitung von 20AP geeignet
suitable for machining of 20AP material

Nuances micro-grain à dureté élevée

Verschleissfeste Feinkornsorten

Wear resistant micro-grain grades

HTAF

μK10 + revêtement PVD
μK10 + PVD Beschichtung
μK10 + PVD coating

- nuance résistante à l'usure, recommandée pour des opérations d'ébauche et de finition
- verschleissfeste Sorte, für Schruppen und Schlichtbearbeitung empfohlen
- wear resistant grade, recommended for roughing and finishing

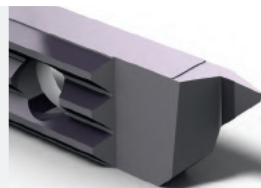

*conseillée pour l'usinage des matières Finemac et inox 4c27a
für Bearbeitung von Finemac und 4c27a-Rostfreier Stahl geeignet
suitable for machining of Finemac and 4c27a stainless steel*

HTAF-RE

μK10 + revêtement PVD
μK10 + PVD Beschichtung
μK10 + PVD coating

- nuance identique à HTAF avec dépouilles rectifiées après revêtement pour des opérations de finition
- gleiche Sorte wie HTAF nach der Beschichtung geschliffener Freiwinkel, für Schlichtbearbeitung empfohlen
- same grade as HTAF, after coating grounded clearance, recommended for finishing

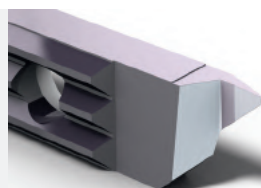

*recommandée pour les matières Finemac et inox 4c27a
für Bearbeitung von Finemac und 4c27a-Rostfreier Stahl geeignet
suitable for machining of Finemac and 4c27a stainless steel*

HTAXF

μK10 + revêtement PVD
μK10 + PVD Beschichtung
μK10 + PVD coating

- nuance complémentaire, résistante à l'usure et à la température pour l'usinage ébauche et finition des matières inox 304, 316L, 317L, 904, Phynox Aciers alliés contenant: Chrome Nickel, Vanadium, molybdène...
- komplementäre Sorte, verschleissfest und temperaturbeständig. Für Schruppen und Schlichtbearbeitung von Materialien Innox 304, 316L, 317L, 904, Phynox Legierter Stahl enthaltend Chrom-Nickel, Vanadium, Molybdän...
- complementary grade, wear and temperature resistant for roughing and finishing of following materials: Innox 304, 316L, 317L, 904, Phynox Alloy steel containing Chrome-nickel, Vanadium, Molybdenum...

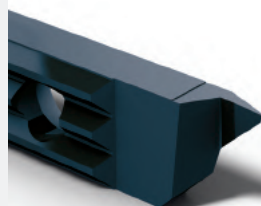

HTAXF-RE

μK10 + revêtement PVD
μK10 + PVD Beschichtung
μK10 + PVD coating

- nuance identique à HTAXF avec dépouilles rectifiées après revêtement pour des opérations de finition
- gleiche Sorte wie HTAXF nach der Beschichtung geschliffener Freiwinkel, für Schlichtbearbeitung empfohlen
- same grade as HTAXF, after coating grounded clearance, recommended for finishing

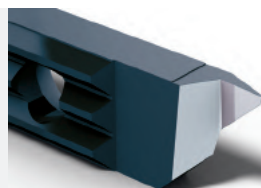

HTiN

μK10 + revêtement PVD
μK10 + PVD Beschichtung
μK10 + PVD coating

- nuance résistante à l'usure, faible coefficient de frottement, recommandée pour des opérations d'ébauche et de finition
- verschleissfeste Sorte, geringer Reibwert, für Schruppen und Schlichtbearbeitung empfohlen
- wear resistant grade, low friction ratio, recommended for roughing and finishing

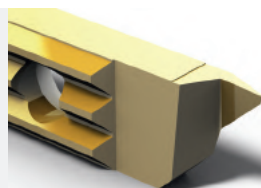

Nuances micro-grain à dureté élevée

Verschleissfeste Feinkornsorten

Wear resistant micro-grain grades

XN (μ K01)

non revêtu
unbeschichtet
uncoated

- nuance micro-grain très résistante à l'usure, recommandée pour des opérations d'ébauche et de finition pour des matières ou usinages nécessitant aucun revêtement
- sehr verschleissfeste Sorte, für Schruppen und Schlichtbearbeitung empfohlen oder für Werkstoffe oder Bearbeitungen, die keine Beschichtung erfordern
- wear resistant micro-grain carbide, recommended for roughing and finishing and for materials or operations that do not necessitate any tool coating

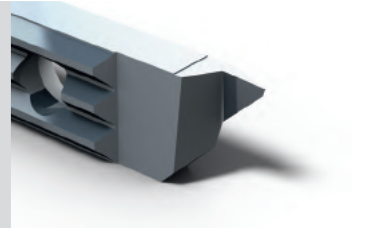

XTC

μ K01 + revêtement PVD
 μ K01 + PVD Beschichtung
 μ K01 + PVD coating

- nuance très résistante à l'usure, faible coefficient de frottement, recommandée pour des opérations de finition
- sehr verschleissfeste Sorte, geringer Reibwert, für Schlichtbearbeitung empfohlen
- very wear resistant grade, low friction ratio, recommended for finishing

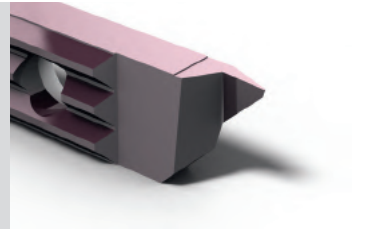

XTAF

μ K01 + revêtement PVD
 μ K01 + PVD Beschichtung
 μ K01 + PVD coating

- nuance très résistante à l'usure, recommandée pour des opérations de finition, conseillée pour l'usinage des matières très abrasives
- sehr verschleissfeste Sorte, für Schlichtbearbeitung empfohlen, für die Bearbeitung von sehr abrasive Rohstoffe geeignet
- very wear resistant grade, recommended for finishing, suitable for machining of very abrasive materials

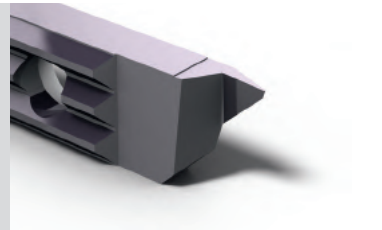

XTAF-RE

μ K01 + revêtement PVD
 μ K01 + PVD Beschichtung
 μ K01 + PVD coating

- nuance identique à XTAF avec dépouilles rectifiées après revêtement pour des opérations de finition
- gleiche Sorte wie XTAF nach der Beschichtung geschliffener Freiwinkel, für Schlichtbearbeitung empfohlen
- same grade as XTAF, after coating grounded clearance, recommended for finishing

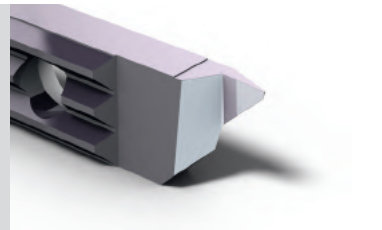

Nuances micro-grain à dureté élevée

Verschleissfeste Feinkornsorten

Wear resistant micro-grain grades

XTAXF

μK01 + revêtement PVD
μK01 + PVD Beschichtung
μK01 + PVD coating

- nuance complémentaire très résistante à l'usure et à la température pour la finition des matières inox 304, 316L, 317L, 904, Phynox
Aciers alliés contenant: Chrome Nickel, Vanadium, Molybdène...
- komplémentere Sorte, sehr verschleissfest und temperaturbeständig. Für Schlichtbearbeitung von Materialien Inox 304, 316L, 317L, 904, Phynox
Legierter Stahl enthaltend Chrom-Nickel, Vanadium, Molybdän...
- complementary grade, very wear and temperature resistant for finishing of following materials: Inox 304, 316L, 317L, 904, Phynox
Alloy steel containing Chrome-nickel, Vanadium, Molybdenum...

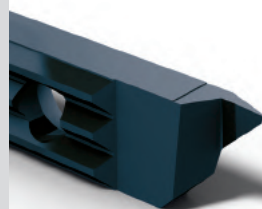

XTAXF-RE

μK01 + revêtement PVD
μK01 + PVD Beschichtung
μK01 + PVD coating

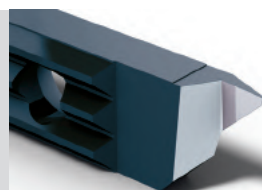

- nuance identique à XTAXF avec dépouilles rectifiées après revêtement pour des opérations de finition
- gleiche Sorte wie XTAXF nach der Beschichtung geschliffener Freiwinkel, für Schlichtbearbeitung empfohlen
- same grade as XTAXF, after coating grounded clearance, recommended for finishing



Pièces de rechange

Ersatzteile

Spare parts

Porte-outils Halter Holders		Serrage standard (A) Standard Spannsystem (A) Standard clamping system (A)		Serrage type B Spannsystem Typ B Clamping system type B	
					
710	710-6 / - NOVIBRA	V-M2.5X5.8-T8	C-T8	-	-
	710-7 / - NOVIBRA / - SF	V-M2.5X6.5-T8		-	-
	710-8 / - NOVIBRA / -SF	V-M2.5X7.8-T8		-	-
	710-10 - 710-12			-	-
730	730-7 / - NOVIBRA	V-M3X7-T8	C-T8	-	-
	730-8 / - NOVIBRA			V-M2.5X7.8-T8	C-T8
	730-10 - 730-12	-		-	-
	730RC	V-M3X5.5-T8		-	-
740	740-7 / -NOVIBRA / -SF	V-M3X7-T8	C-T8	-	-
	740-8 -12 / -SF / -NOVIBRA			V-M2.5X7.8-T8	C-T8
750	750RC	V-M4X7.3-T15	C-T15	-	-
770	770-SN-SF	V-M4X7.3-T15	C-T15	-	-

Porte-outils

Halter

Holder

L

710

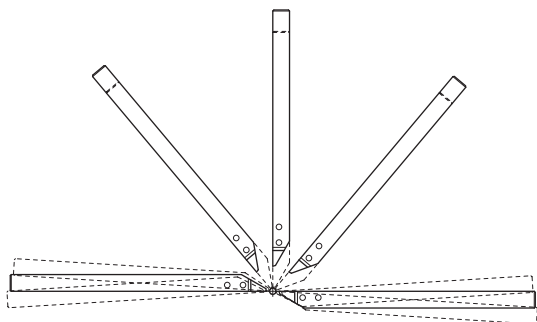

Porte-outils pour machines à cames à gauche
 Halter für linksdrehende kurvgesteuerte Maschinen
 Tool holders for left hand turning cam driven machines

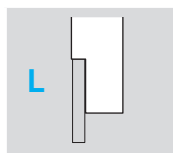
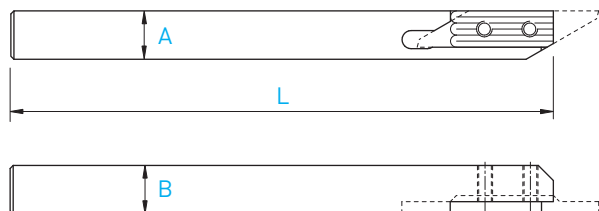

A x B	L	Serrage Spannsystem Clamping	Art. N°
6 x 6	115	A	710-6
7 x 7	115	A	710-7
8 x 8	115	A	710-8
8 x 8	140	A	710-8-140
10 x 10	115	A	710-10
12 x 12	130	A	710-12



Chaque support est livré avec vis et clé.
 Jeder Halter wird mit Spanschraube(n) und Schlüssel geliefert.
 Screw(s) and key are included with each tool holder.

Porte-outils

Halter

Holders

L

710-SF

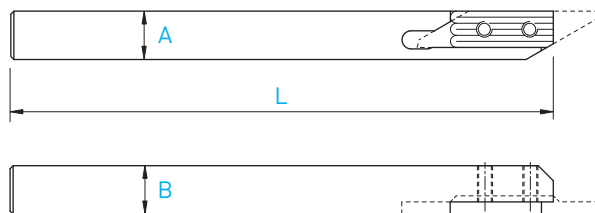

Super finition des 4 faces
4 seitig feinstgeschliffen
4 sides superfinish

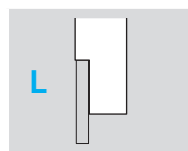

A x B	L	Serrage Spannsystem Clamping	Art. N°
7 x 7	140	A	710-7-140-SF
8 x 8	140	A	710-8-140-SF

Porte-outils en métal lourd anti-vibratoire

Schwingungdämpfender Schwermetallhalter

Low vibration heavy metal holders

L

710-NOVIBRA

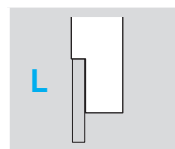
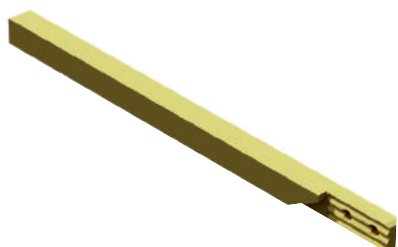

A x B	L	Serrage Spannsystem Clamping	Art. N°
6 x 6	115	A	710-6-NOVIBRA
7 x 7	115	A	710-7-NOVIBRA
8 x 8	115	A	710-8-NOVIBRA

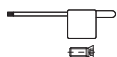

Chaque support est livré avec vis et clé.
Jeder Halter wird mit Spannschraube(n) und Schlüssel geliefert.
Screw(s) and key are included with each tool holder.

TOP-WATCH

Plaquettes d'horlogerie pour machines à cames
 Uhrenindustrie-WSP für kurvengesteuerte Maschinen
 Watch industry inserts for cam driven machines

L

711SF / 712SF

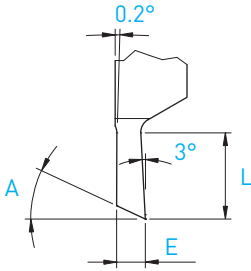
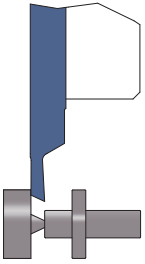

Tronçonnage
 Abstechen
 Parting off

E	L	A	Art. N°	HTC	HTC-RE	HTAF	HTiN	HN (µK10)
0.8	3.0	25°	711SF-0.8-25°	■	■	■	■	■
1.0	3.0	25°	711SF-1.0-25°	■	□	■	□	■

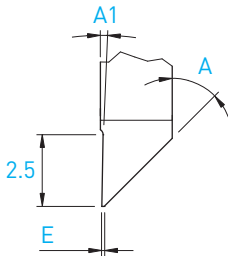
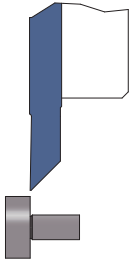

Tournage avant ébauche / finition
 Vorwärts drehen schruppen / schlichten
 Front turning for roughing / finishing

E	A	A1	Art. N°	HTC	HTC-RE	HTAF	HTiN	HN (µK10)
0.03	45°	3°	712SF-3/3-45°	■	□	■	□	■
0.08	45°	1°	712SF-8/8-45°	■	■	■	□	■

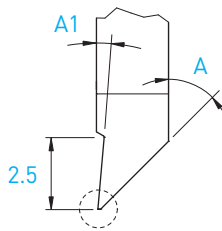
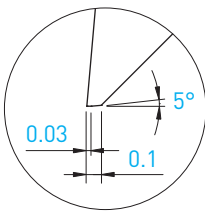
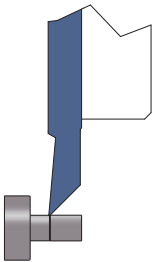

Tournage avant finition (pivotage)
 Vorwärts drehen schlichten
 Front turning for finishing

A	A1	Art. N°	HTC	HTC-RE	HTAF	HTiN	HN (µK10)
45°	3°	712SF-10/3	■	□	■	■	■

Plaquettes d'horlogerie pour machines à cames

Uhrenindustrie-WSP für kurvengesteuerte Maschinen

Watch industry inserts for cam driven machines

L

713SF

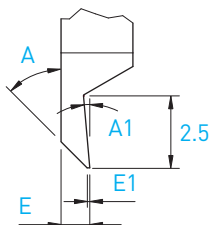
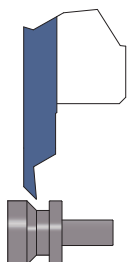

Tournage arrière ébauche / finition
Rückwärts drehen schrappen / schlichten
Back turning for roughing / finishing

E1	E	A	A1	Art. N°	HTC	HTC-RE	HTAF	HTiN	HN (µK10)
0.03	1.0	45°	5°	713SF-3/3-45°-1.0	■	□	□	□	■
0.10	1.0	45°	5°	713SF-10/10-45°-1.0	■	□	■	□	■

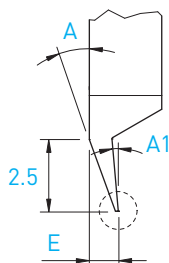
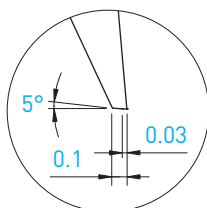
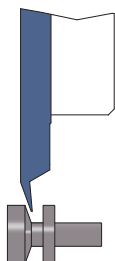

Tournage arrière finition
Rückwärts drehen schlichten
Back turning for finishing

E	A	A1	Art. N°	HTC	HTC-RE	HTAF	HTiN	HN (µK10)
1.0	20°	5°	713SF-10/3	■	□	■	■	■

Plaquettes ébauches

WSP-Rohlinge

Blank inserts

L

711-ESF

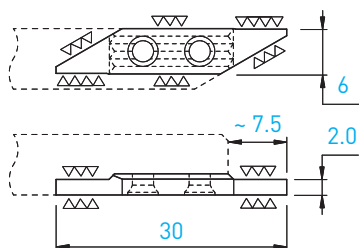

Art. N°	HTC	HTAF	HTiN	HN (µK10)	XN (µK01)	XTC	XTAF
711-ESF	■	■	□	■	■	■	■

Porte-outils

Halter

Holder

L/R

730 / 740

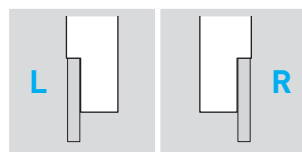
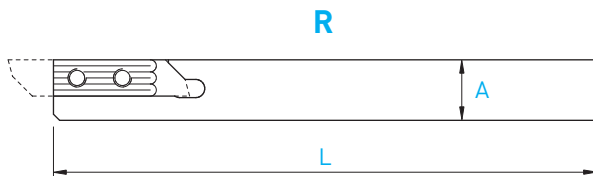
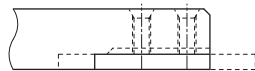
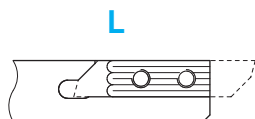

A x B	L	Serrage Spannsystem Clamping	Art. N°	Art. N°
7 x 7	115	A	730-7	740-7
8 x 8	115	A + B	730-8	740-8
8 x 8	140	A + B	730-8-140	-
10 x 10	115	A + B	730-10	740-10
12 x 12	130	A + B	730-12	740-12
12 x 12	90	A + B	730-12-90	740-12-90

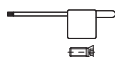

Chaque support est livré avec vis et clé.
Jeder Halter wird mit Spannschraube(n) und Schlüssel geliefert.
Screw(s) and key are included with each tool holder.

Porte-outils

Halter

Holder

R

740-SF

R

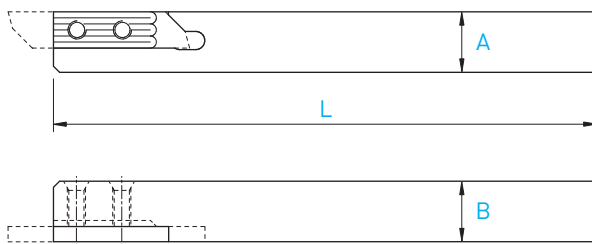

Super finition des 4 faces
4 seitig feinstgeschliffen
4 sides superfinish

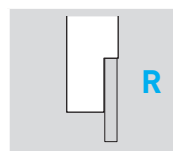

A x B	L	Serrage Spannsystem Clamping	Art. N°
7 x 7	90	A	740-7-90-SF
8 x 8	115	A + B	740-8-SF
8 x 8	90	A + B	740-8-90-SF
10 x 10	115	A + B	740-10-SF
10 x 10	90	A + B	740-10-90-SF
12 x 12	130	A + B	740-12-SF
12 x 12	90	A + B	740-12-90-SF

Porte-outils en métal lourd anti-vibratoire

Schwingungdämpfender Schwermetallhalter

Low vibration heavy metal holders

L/R

730 / 740-NOVIBRA

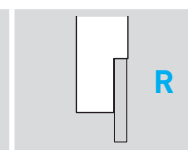
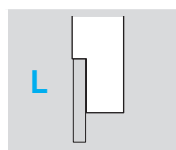

A x B	L	Serrage Spannsystem Clamping	Art. N°	Art. N°
7 x 7	115	A	730-7-NOVIBRA	740-7-NOVIBRA
8 x 8	115	A + B	730-8-NOVIBRA	740-8-NOVIBRA
8 x 8	80	A + B	-	740-8-80-NOVIBRA
10 x 10	115	A + B	-	740-10-NOVIBRA
12 x 12	130	A + B	-	740-12-NOVIBRA

Chaque support est livré avec vis et clé.
Jeder Halter wird mit Spannschraube(n) und Schlüssel geliefert.
Screw(s) and key are included with each tool holder.

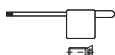

Porte-outils

Halter

Holder

R

740X3-SF

new

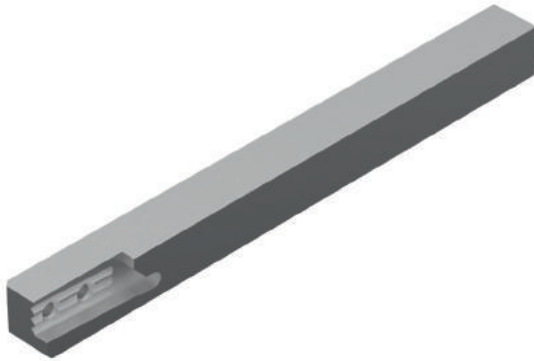
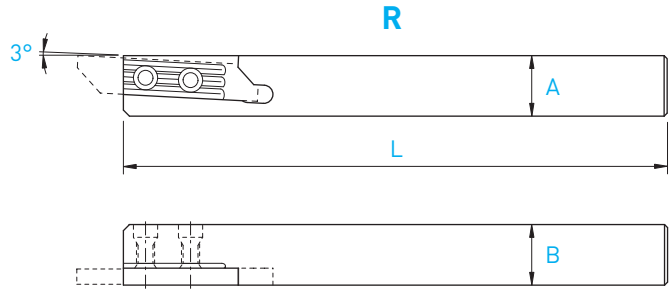

A x B	L	Serrage Spannsystem Clamping	Art. N°
8 x 8	115	A + B	740X3-8-SF
10 x 10	115	A + B	740X3-10-SF
12 x 12	130	A + B	740X3-12-SF

Plaquettes d'horlogerie pour machines CNC

Uhrenindustrie-WSP für CNC-Maschinen

Watch industry inserts for CNC machines

R

741SF / 742SF

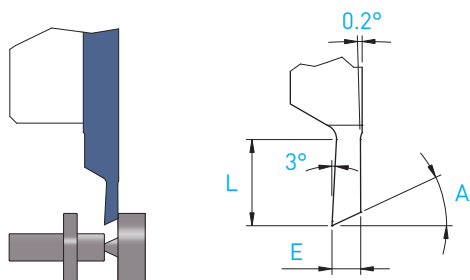

Tronçonnage
Abstechen
Parting off

E	L	A	Art. N°	HTC	HTC-RE	HTAF	HTAF-RE	HTAXF	HTAXF-RE	HTIN	HN (µK10)	XTAF	XTAXF	XTAXF-RE	XN (µK01)
0.5	2.0	25°	741SF-0.5-25°	■	□	■	□	■	□	□	■	■	■	■	□
0.8	3.0	25°	741SF-0.8-25°	■	□	■	□	■	□	□	■	■	■	■	□
1.0	3.0	25°	741SF-1.0-25°	■	□	■	□	■	□	□	■	■	■	■	□
1.2	6.0	22°	741SF-1.2-22°	■	□	■	□	■	□	□	■	■	■	■	□

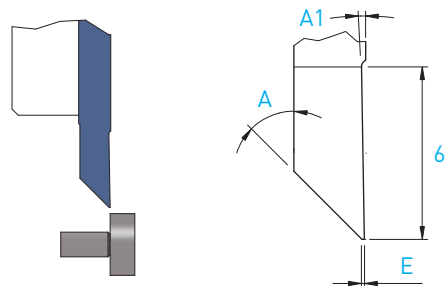

Tournage avant ébauche / finition
Vorwärts drehen schrumpfen / schlichten
Front turning for roughing / finishing

E	A	A1	Art. N°	HTC	HTC-RE	HTAF	HTAF-RE	HTAXF	HTAXF-RE	HTIN	HN (µK10)	XTAF	XTAXF	XTAXF-RE	XN (µK01)
0.03	45°	3°	742SF-3/3-45°	■	■	■	■	■	■	□	■	■	■	■	■
0.08	45°	1°	742SF-8/8-45°	■	■	■	■	■	■	□	■	■	■	■	■

■ = disponible / verfügbar / available

□ = selon disponibilité du stock / jenach Lagerverfügbarkeit / depending on stock availability

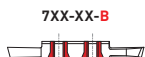

Sur demande pour serrage type B, voir page 2.25
Wahlweise für B-Spannsystem, siehe Seite 2.25
On request for B clamping system, see page 2.25

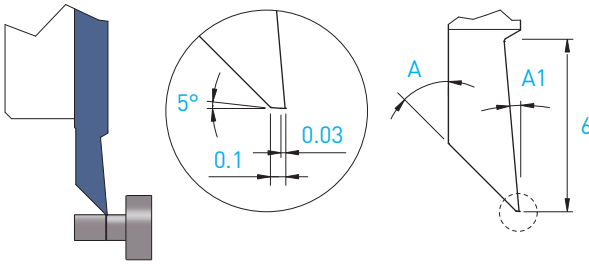

Tournage avant finition
 Vorwärts drehen schlichten
 Front turning for finishing

A	A1	Art. N°	HTC	HTC-RE	HTAF	HTAF-RE	HTAXF	HTAXF-RE	HTIN	HN (μK10)	XTAF	XTAXF	XTAXF-RE	XN (μK01)
45°	5°	742SF-10/3	■	■	■	□	□	□	■	■	■	■	□	□

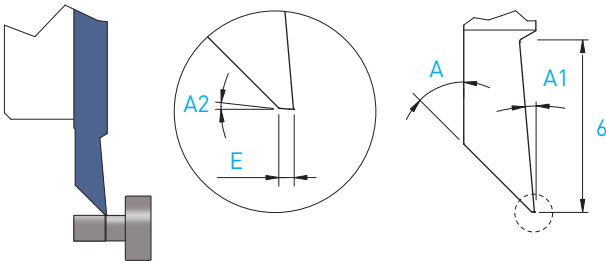

Tournage avant finition
 Vorwärts drehen schlichten
 Front turning for finishing

E	A	A1	A2	Art. N°	HTAF-RE	XTAF-RE
0.10	45°	5°	5°	742SF-10/0-5°-45°	■	■
0.15	30°	3°	2°	742SF-15/0-2°-30°	■	■

7XX-XX-B

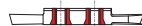

Sur demande pour serrage type B, voir page 2.25
 Wahlweise für B-Spannsystem, siehe Seite 2.25
 On request for B clamping system, see page 2.25

Plaquettes d'horlogerie pour machines CNC

Uhrenindustrie-WSP für CNC-Maschinen

Watch industry inserts for CNC machines

R

743SF

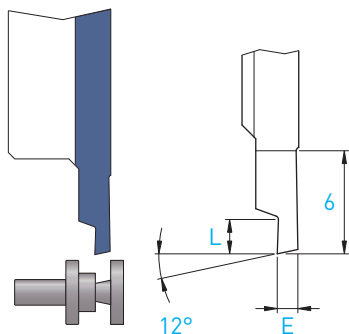

Tournage arrière ébauche
Rückwärts drehen schrappen
Back turning for roughing

E	L	Art. N°	HTC	HTAF	HN (µK10)
1.2	2.5	743SF-120/0-12°	■	■	■
1.4	3.0	743SF-140/0-12°	■	■	■
1.6	3.0	743SF-160/0-12°	■	■	■
1.8	4.0	743SF-180/0-12°	■	■	■

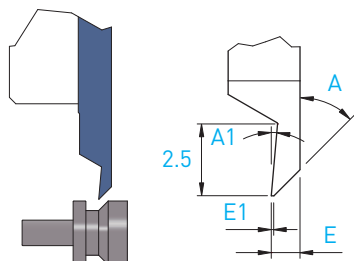

Tournage arrière ébauche/finition
Rückwärts drehen schrappen/schlichten
Back turning for roughing/finishing

E1	E	A	A1	Art. N°	HTC	HTC-RE	HTAF	HTAF-RE	HTAXF	HTAXF-RE	HTiN	HN (µK10)	XTAF	XTAXF	XTAXF-RE	XN (µK01)
0.03	1.0	45°	5°	743SF-3/3-45°-1.0	■	■	■	■	■	■	□	■	■	■	■	■
0.03	1.2	45°	5°	743SF-3/3-45°-1.2	■	■	■	■	■	■	□	■	■	■	■	■
0.10	1.0	45°	5°	743SF-10/10-45°-1.0	■	■	■	■	■	■	□	■	■	■	■	■
0.05	0.8	30°	3°	743SF-5/5-30°-0.8			■									
0.05	1.0	30°	3°	743SF-5/5-30°-1.0			■									

7XX-XX-B



Sur demande pour serrage type B, voir page 2.25
Wahlweise für B-Spannsystem, siehe Seite 2.25
On request for B clamping system, see page 2.25

■ = disponible / verfügbar / available
□ = selon disponibilité du stock / jenach Lagerverfügbarkeit / depending on stock availability

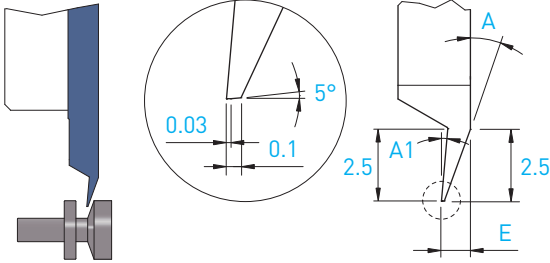

Tournage arrière finition
 Rückwärts drehen schlichten
 Back turning for finishing

E	A	A1	Art. N°	HTC	HTC-RE	HTAF	HTAF-RE	HTAXF	HTAXF-RE	HTIN	HN (µK10)	XTAF	XTAXF	XTAXF-RE	XN (µK01)
1.0	20°	5°	743SF-10/3	■	■	■	■	■	■	□	■	■	■	□	□

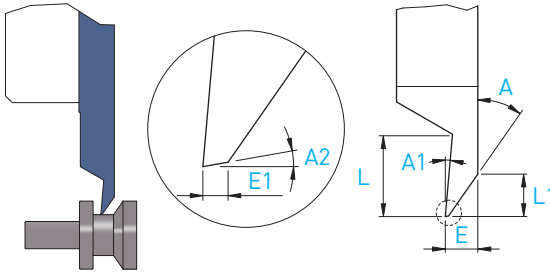

Tournage arrière finition
 Rückwärts drehen schlichten
 Back turning for finishing

E1	E	L1	L	A	A1	A2	Art. N°	HTAF-RE	XTAF-RE
0.08	1.0	1.6	2.5	30°	5°	2°	743SF-8/0-2°-30°-1.0	■	■
0.15	1.2	1.8	4.0	30°	3°	2°	743SF-15/0-2°-30°-1.2	■	■
0.10	1.0	1.3	2.5	35°	5°	10°	743SF-10/0-10°-35°-1.0	■	■

7XX-XX-B



Sur demande pour serrage type B, voir page 2.25
 Wahlweise für B-Spannsystem, siehe Seite 2.25
 On request for B clamping system, see page 2.25

Filetage à profil partiel – norme NIHS

Gewinde drehen mit Teilprofil – Norm NIHS

Threading with partial profile – norm NIHS

R/L

746SF / 736SF

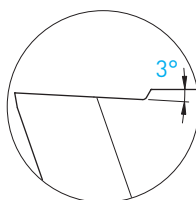
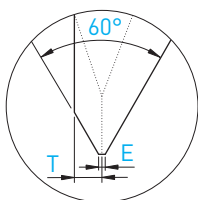
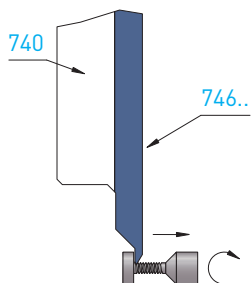

Filetage à droite
sens rotation machine M3

Rechtgewinde Drehrichtung
der Maschine M3

Right-hand thread rotating
machinery M3

Filetage Gewinde drehen Threading	Pas Steigung Pitch P	T	E 0/-0.01	Art. N°	HTAF HN (µK10)
S0.50	0.125	0.07	0.015	746SFX3-A60-S0.50-AR	■ ■
S0.60	0.150	0.09	0.020	746SFX3-A60-S0.60-AR	■ ■
S0.70	0.175	0.10	0.020	746SFX3-A60-S0.70-AR	■ ■
S0.80	0.200	0.12	0.025	746SFX3-A60-S0.80-AR	■ ■
S0.90	0.225	0.13	0.030	746SFX3-A60-S0.90-AR	■ ■
S1.00	0.250	0.15	0.035	746SFX3-A60-S1.00-AR	■ ■

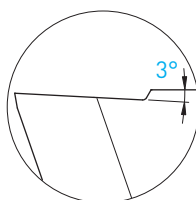
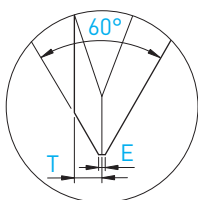
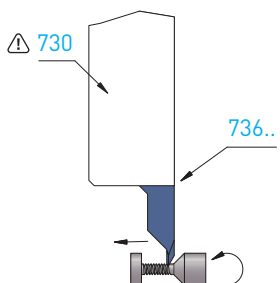
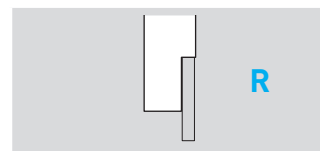

Filetage à droite
sens rotation machine M4

Rechtgewinde Drehrichtung
der Maschine M4

Right-hand thread rotating
machinery M4

Filetage Gewinde drehen Threading	Pas Steigung Pitch P	T	E 0/-0.01	Art. N°	HTAF HN (µK10)
S0.50	0.125	0.07	0.015	736SFX3-A60-S0.50-AR	■ ■
S0.60	0.150	0.09	0.020	736SFX3-A60-S0.60-AR	■ ■
S0.70	0.175	0.10	0.020	736SFX3-A60-S0.70-AR	■ ■
S0.80	0.200	0.12	0.025	736SFX3-A60-S0.80-AR	■ ■
S0.90	0.225	0.13	0.030	736SFX3-A60-S0.90-AR	■ ■
S1.00	0.250	0.15	0.035	736SFX3-A60-S1.00-AR	■ ■

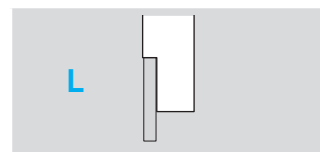

7XX-XX-B



Sur demande pour serrage type B, voir page 2.25
Wahlweise für B-Spannsystem, siehe Seite 2.25
On request for B clamping system, see page 2.25

■ = disponible / verfügbar / available
□ = selon disponibilité du stock / jenach Lagerverfügbarkeit / depending on stock availability

TOP-WATCH

Plaquettes piqûre avant

Frontestich WSP

Front grooving inserts

R

748SF

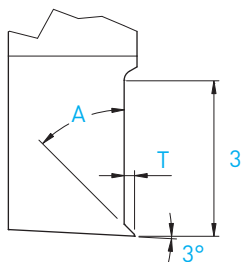
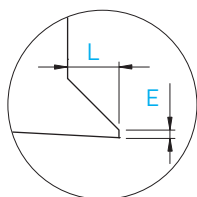
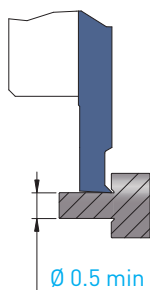

$E_{0/-0.01}$	A	T	Art. N°	HTC	HTC-RE	HTAF	HTAF-RE	HTIN	HN ($\mu\text{K}10$)
0.03	45°	0.2	748SF-E03-A45°-L20	■	■	■	■	□	■
0.05	45°	0.3	748SF-E05-A45°-L30	■	■	■	■	■	■
0.08	45°	0.5	748SF-E08-A45°-L50	■	■	■	■	□	■

Plaquettes piqûre arrière

Rückestich WSP

Back grooving inserts

R

749SF

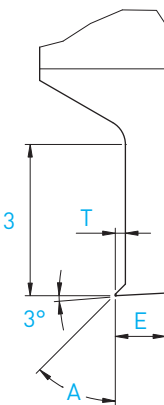
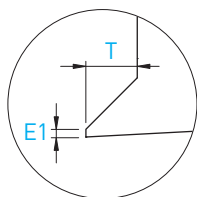
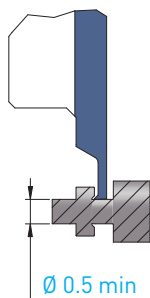

$E1_{0/-0.01}$	A	T	E	Art. N°	HTC	HTC-RE	HTAF	HTAF-RE	HTIN	HN ($\mu\text{K}10$)
0.03	45°	0.2	1.0	749SF-E03-A45°-L20-B100	■	■	■	■	□	■
0.05	45°	0.3	1.0	749SF-E05-A45°-L30-B100	■	□	■	■	□	■
0.08	45°	0.5	1.2	749SF-E08-A45°-L50-B120	■	■	■	■	□	■

7XX-XX-B



Sur demande pour serrage type B, voir page 2.25
Wahlweise für B-Spannsystem, siehe Seite 2.25
On request for B clamping system, see page 2.25

Plaquettes ébauches

WSP-Rohlinge

Blank inserts

L/R

731-ESF / 741-ESF

L

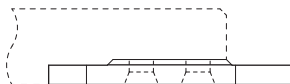
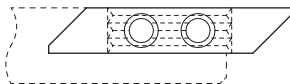

R

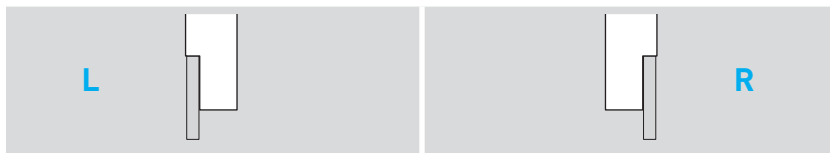
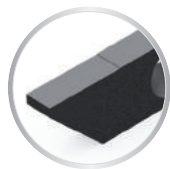
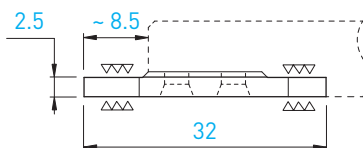
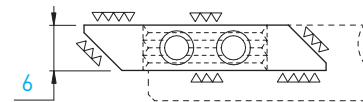

L				R													
Art. N°	HTC	HTAF	HTAXF	HTIN	HN (μK10)	XTC	XTAF	XN (μK01)	Art. N°	HTC	HTAF	HTAXF	HTIN	HN (μK10)	XTC	XTAF	XN (μK01)
731-ESF	■	■	■	■	■	■	■	■	741-ESF	■	■	■	■	■	■	■	■

7XX-XX-B



Sur demande pour serrage type B, voir page 2.25
Wahlweise für B-Spannsystem, siehe Seite 2.25
On request for B clamping system, see page 2.25

■ = disponible / verfügbar / available

□ = selon disponibilité du stock / jenach Lagerverfügbarkeit / depending on stock availability

Porte-outils

Halter

Holder

Coupe à droite déportée

Versetztes Rechtsschneiden

Right cut off line

730RC / 750RC

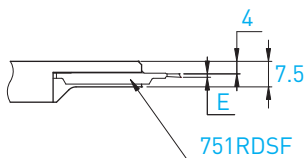
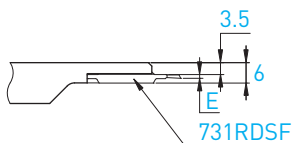
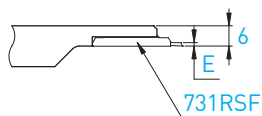
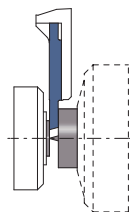

L (R)

Coupe à droite déportée
Versetztes Rechtsschneiden
Right cut off line



A x B	L	L1	Art. N°
8 x 8	115	24	730RC-8
10 x 10	115	24	730RC-10
12 x 12	130	30	730RC-12
16 x 16	130	40	730RC-16

A x B	L	L1	Art. N°
12 x 12	130	30	750RC-12
16 x 16	130	40	750RC-16

Tronçonnage
Abstechen
Parting off

Coupe à droite déportée
Versetztes Rechtsschneiden
Right cut off line

731R / 751R

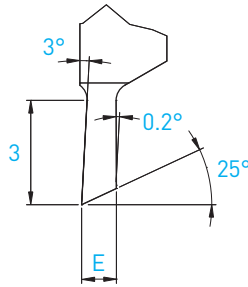
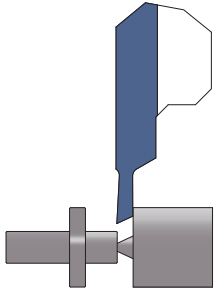

L (R)
Coupe à droite déportée
Versetztes Rechtsschneiden
Right cut off line

E	Art. N°	HTAF	HTIN	HN (µK10)
1.0	731RSF-1.0-25°	■	■	■

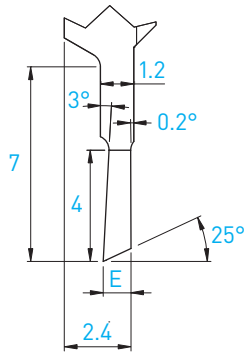
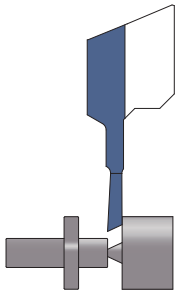

L (R)
Coupe à droite déportée
Versetztes Rechtsschneiden
Right cut off line

E	Art. N°	HTAF	HTIN	HN (µK10)
0.8	731RDSF-0.8-25°	■	■	■
1.0	731RDSF-1.0-25°	■	□	■

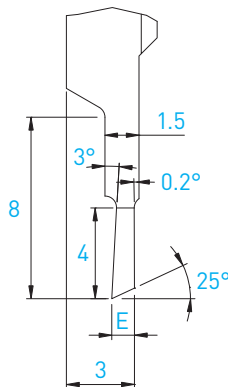
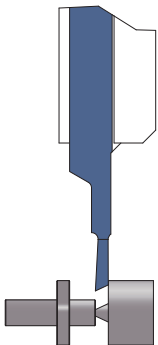

L (R)
Coupe à droite déportée
Versetztes Rechtsschneiden
Right cut off line

E	Art. N°	HTAF	HTIN	HN (µK10)
0.8	751RDSF-0.8-25°	■	■	■
1.0	751RDSF-1.0-25°	■	□	■

■ = disponible / verfügbar / available
□ = selon disponibilité du stock / jenach Lagerverfügbarkeit / depending on stock availability

new

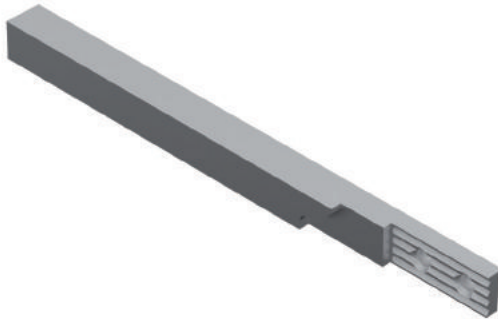
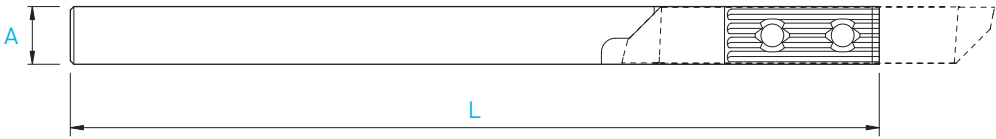

L (R)

Coupe à droite déportée
Versetzttes Rechtsschneiden
Right cut off line



A x B	L	Art. N°
8.2 x 8	115	770-8.2X8-SN4-SF

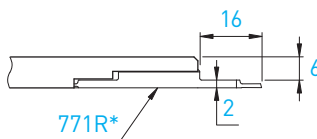
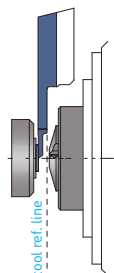
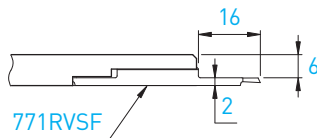
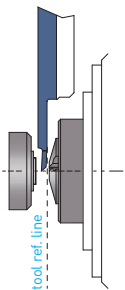

* voir TOP-Line
* siehe TOP-Line
* see TOP-Line

Porte-outils

Halter

Holders

SwissNANO 7

770-SN7-SF

new

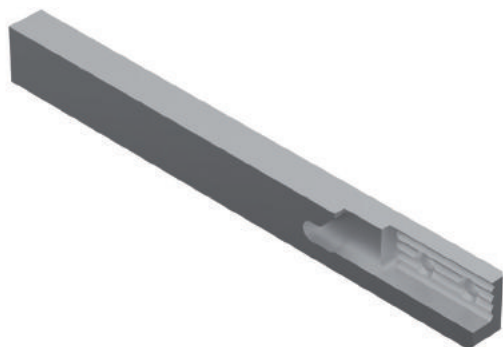
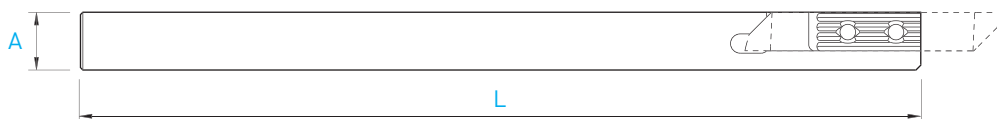

L (R)

Coupe à droite déportée
Versetzttes Rechtsschneiden
Right cut off line



A x B	L	Art. N°
12 x 8	115	770-12X8-SN7-SF

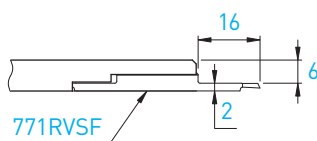
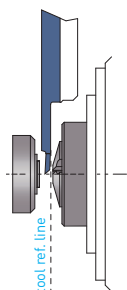

771RVSF

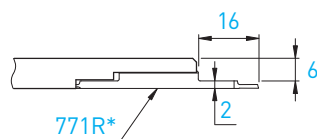
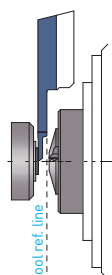

771R*

* voir TOP-Line
* siehe TOP-Line
* see TOP-Line

TOP-WATCH

Plaquette

Wendplatte

Insert

Coupe à gauche déportée

Versetztes Linksschneiden

Left cut off line

new

771RVSF

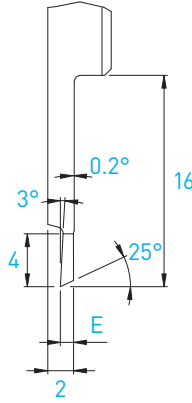
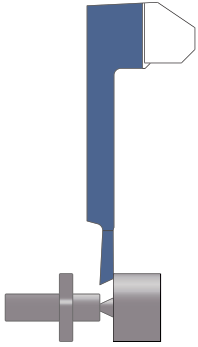

R (L)

Coupe à gauche déportée
Versetztes Linksschneiden
Left cut off line

E	Art. N°	TAF	N (µK20)
1.0	771RVSF-1.0-25°	■	■
1.2	771RVSF-1.2-25°	■	■
1.5	771RVSF-1.5-25°	■	■

Porte-outils spéciaux de tronçonnage

Sonder Abstechwerkzeughalter

Special parting off tool holders

MODU-LINE

ML12

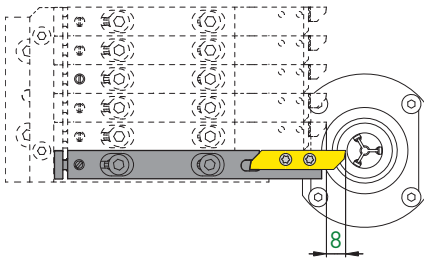

Type de machine Maschinen-Typ Type of machine	Porte-outils Halter Holders	Art. N°	Plaquettes type WSP Typ Inserts type
SwissNano	ML12	ML12A-730RC-SWISS-NANO	731RSF / 731RDSF
SwissNano	ML12	ML12A-750RC-SWISS-NANO	751RDSF

Voir documentation MODU-Line
Siehe MODU-Line Dokumentation
See MODU-Line documentation

L'outil de référence pour le décolletage

Hochwertiges Wendeplattensystem für Langdrehautomaten

Top class turning tool for automatic lathes

700 Series

100% rigid!

Système de serrage Applitec à denture décalée
 Applitec-Spannsystem mit verschobener Verzahnung
 Applitec clamping system with shifted teeth

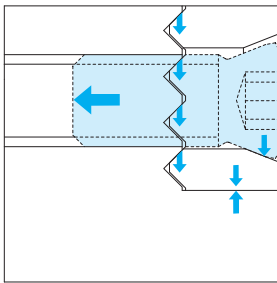
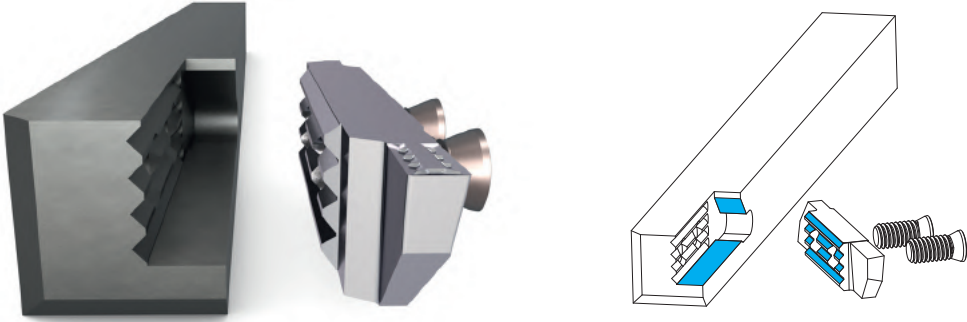

Serrage standard (A)
Standard Spannsystem (A)
Standard clamping system (A)

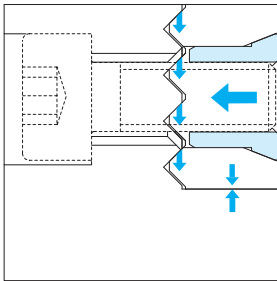
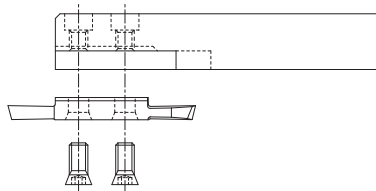

Serrage type B*
Spannsystem Typ B*
Clamping system type B*

ajouter -B après le numéro d'article
 -B nach der Artikelreferenz hinzufügen
 add -B after the article number

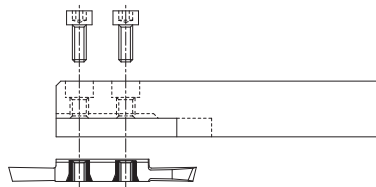

Changement de la plaquette possible dans la machine, sans démontage du porte-outil
 WSP-Austauschmöglichkeit in der Maschine ohne Halterausbau
 The insert can be changed in the machine without removing the tool holder

APPLITEC



INFO









Codification Bezeichnungsschlüssel Designation key	Paramètres de coupe indicatifs Empfohlene Schnittwerte Standard machining data	Nuances Sorten Grades	> 3.02
--	--	-----------------------------	---------------

**SERIES
630 / 640**

Tournage
et gorge

Drehen und
Einstechen

Turning and
grooving

Porte-outils Halter Holders		630 / 640	> 3.06
Tournage avant Vorwärts drehen Front turning		632 / 642	> 3.08
Tournage arrière Rückwärts drehen Back turning		633 / 643	> 3.11
Fonçage-tournage Einstechen und drehen Grooving and turning		634 / 644	> 3.19
Chanfreinage Anfasen Chamfering		635 / 645	> 3.24
Filetage Gewinde drehen Threading		636 / 646	> 3.26
Plaquettes à rayon Radius Wendepplatten Radius inserts		637 / 647	> 3.28
Plaquettes ébauches WSP-Rohlinge Blank inserts		631-EP / 641-EP	> 3.30

**SERIES
650 / 660**

Tronçonnage

Abstechen

Parting off

Porte-outils Halter Holders		650 / 660	> 3.31
Tronçonnage Abstechen Parting off		651 / 661	> 3.34
Tronçonnage - coupe déportée Abstechen - versetztes Schneiden Parting off - cut off line		651R	> 3.39
Plaquettes ébauches WSP-Rohlinge Blank inserts		651-EP / 661-EP	> 3.44

Pièces de rechange et accessoires Ersatzteile und Zubehör Spare parts and accessories	> 3.45
---	---------------

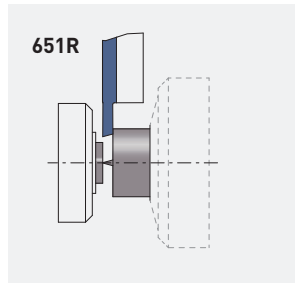
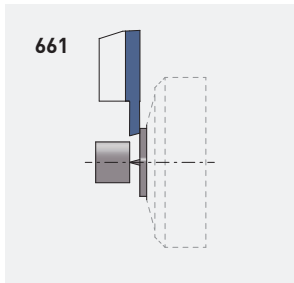
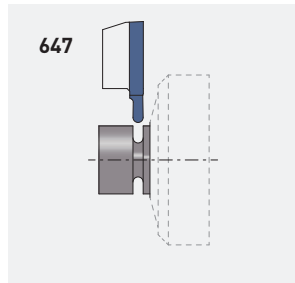
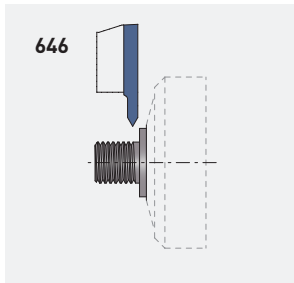
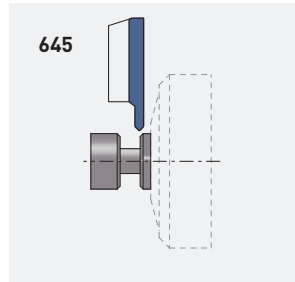
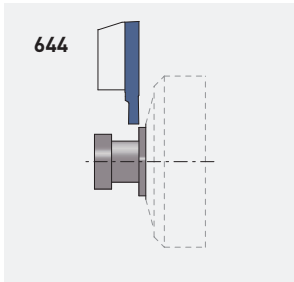
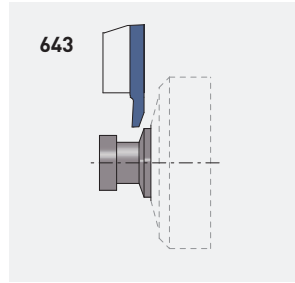
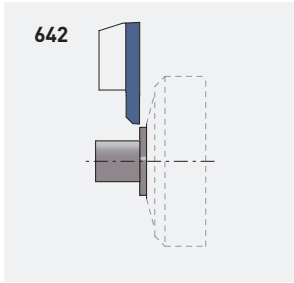

Codification des plaquettes PRO-Line série 600

WSP-Bezeichnungssystem für PRO-Line 600 Serie

Inserts designation key for PRO-Line 600 series

INFO

6 4 4 X - 2.0 - R15 - TiAlN

Dimension
Abmessung
Dimension

Rayon
Radius
Radius

Nuance
Sorte
Grade

Géométrie de coupe
Schneidgeometrie
Cutting geometry

brise-copeau
Spanbrecher
chip breaker

particularités
Sondereigenschaften
special features

Géométrie d'usinage
Bearbeitungsgeometrie
Machining geometry

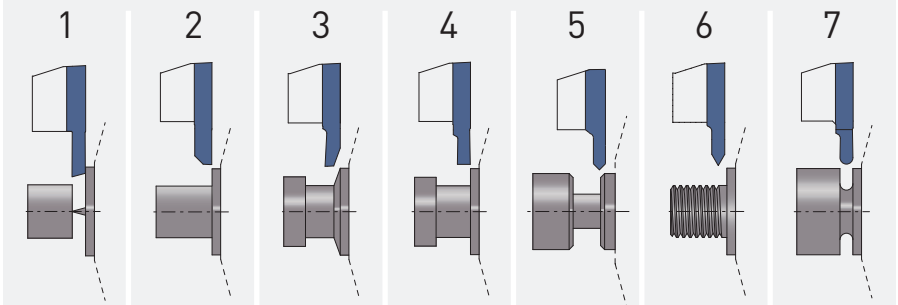

Gamme de produit
Produktserie
Product series

définit la compatibilité des plaquettes avec le porte-outil
bestimmt die WSP und Halter Kompatibilität
shows the inserts and holder compatibility

L = 3, 5

(chiffre impair / ungerade Zahl / uneven number)

R = 4, 6

(chiffre pair / gerade Zahl / even number)

SERIES

Tournage
et gorge

Drehen und
Einstechen
Turning and
grooving

W max = 3 mm
L max = 8 mm

L

630

R

640

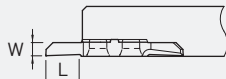

SERIES

Tronçonnage
Abstechen
Parting off

W max = 2.5 mm
L max = 11 mm

L

650

R

660

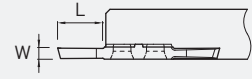

Applitec série 600
Applitec 600 Serie
Applitec 600 series

Système de serrage à denture avec 2 vis de fixation
Spannsystem mit Verzahnung und 2 Schrauben
Teeth clamping system with 2 screws

Paramètres de coupe indicatifs

Empfohlene Schnittwerte

Standard machining data

Matière Werkstoff Material	Tournage Drehen Turning			Tronçonnage Abstechen Parting off		
	VC	630/640		VC	650/660	
		Prof. de passe Schnitttiefe Depth of cut	Avance Vorschub Feed		Largeur de coupe Abstechbreite Cutting width	Avance Vorschub Feed
(m/min)	(mm)	(mm/U)	(m/min)	(mm)	(mm/U)	
Acier de décolletage Automatenstahl Free-cutting steel	P 120 - 200	0.05 - 1.0 1.0 - 4.0	0.01 - 0.15 0.05 - 0.25	80 - 150	0.50 - 1.50 1.50 - 2.50	0.01 - 0.08 0.03 - 0.15
Acier Stahl < 600 N/mm ² Steel	P 80 - 160	0.05 - 1.0 1.0 - 4.0	0.01 - 0.15 0.05 - 0.25	70 - 120	0.50 - 1.50 1.50 - 2.50	0.01 - 0.06 0.03 - 0.12
Acier Stahl < 800 N/mm ² Steel	P 60 - 120	0.05 - 1.0 1.0 - 4.0	0.01 - 0.10 0.05 - 0.20	60 - 100	0.50 - 1.50 1.50 - 2.50	0.01 - 0.05 0.03 - 0.10
Acier Stahl > 800 N/mm ² Steel	P 50 - 100	0.05 - 1.0 1.0 - 3.0	0.01 - 0.08 0.05 - 0.15	40 - 80	0.50 - 1.50 1.50 - 2.50	0.01 - 0.04 0.03 - 0.08
Acier inoxydable Rostfreistahl Stainless steel	M 60 - 120	0.05 - 1.0 1.0 - 3.0	0.01 - 0.08 0.05 - 0.15	60 - 100	0.50 - 1.50 1.50 - 2.50	0.01 - 0.04 0.03 - 0.08
Aluminium Si <12%	N 200 - 1000	0.05 - 1.0 1.0 - 4.0	0.01 - 0.20 0.05 - 0.40	180 - 400	0.50 - 1.50 1.50 - 2.50	0.01 - 0.10 0.03 - 0.20
Aluminium Si >12%	N 180 - 800	0.05 - 1.0 1.0 - 4.0	0.01 - 0.20 0.05 - 0.40	150 - 300	0.50 - 1.50 1.50 - 2.50	0.01 - 0.10 0.03 - 0.20
Cuivre, laiton, bronze Kupfer, Messing, Bronze Copper, brass, bronze	N 100 - 500	0.05 - 1.0 1.0 - 4.0	0.01 - 0.20 0.05 - 0.35	100 - 300	0.50 - 1.50 1.50 - 2.50	0.01 - 0.10 0.03 - 0.20
Titane Titan Titanium	S 30 - 70	0.05 - 1.0 1.0 - 4.0	0.01 - 0.08 0.05 - 0.15	30 - 50	0.50 - 1.50 1.50 - 2.50	0.01 - 0.03 0.03 - 0.06

Nuances

Sorten

Grades

TiAlN

μK20 + revêtement PVD
μK20 + PVD Beschichtung
μK20 + PVD coating

- excellente nuance universelle
- 1^{er} choix pour l'usinage des aciers, aciers inoxydables et alliages de titane
- très bonne résistance à la température

- beste Universalsorte
- für die Bearbeitung von Stahl, rostfreiem Stahl und Titanlegierungen bestens geeignet
- sehr gute Warmfestigkeit

- best universal grade
- first choice for steel, stainless steel and titanium alloys machining
- very good heat resistance

N (μK20)

non revêtu
unbeschichtet
uncoated

- nuance micro-grain tenace
- supporte les coupes interrompues et autres conditions d'usinage défavorables

- zähe Feinkornsorte
- für unterbrochene Schnitte und andere ungünstige Bearbeitungsbedingungen geeignet

- tough micro-grain grade
- suitable for interrupted cut and other unfavorable machining conditions

HTA

μK10 + revêtement PVD
μK10 + PVD Beschichtung
μK10 + PVD coating

- nuance très résistante à l'usure
- pour l'usinage en finition dans des conditions favorables des aciers, aciers inoxydables et alliages de titane

- sehr verschleissfeste Sorte
- für die Feinbearbeitung von Stahl, rostfreiem Stahl und Titanlegierungen bei guten Bearbeitungsbedingungen

- very wear resistant grade
- for light machining of steel, stainless steel and titanium alloys under favorable machining conditions

HN (μK10)

non revêtu
unbeschichtet
uncoated

- nuance micro-grain très résistante à l'usure
- recommandé pour l'usinage du titane faiblement allié
- déconseillé en cas de coupe interrompue et autres conditions d'usinage défavorables

- verschleissfeste Feinkornsorte
- für die Bearbeitung von niedrig legiertem Titan empfehlenswert
- für unterbrochene Schnitte und andere ungünstige Bearbeitungsbedingungen nicht geeignet

- wear resistant micro-grain grade
- suitable for the machining of low alloyed titanium
- not suitable for interrupted cut and other unfavorable machining conditions

L

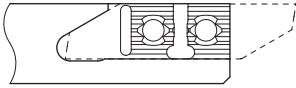

R

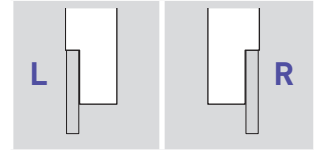
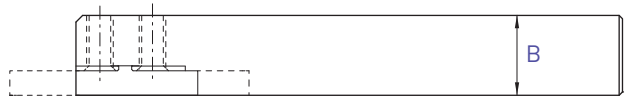
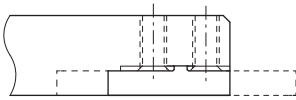
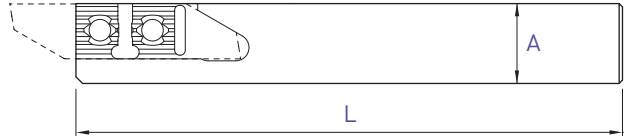

A x B	L	Art. N°	Art. N°
8 x 8	115	630-8	640-8
10 x 10	115	630-10	640-10
10 x 10	50	630-10-50	640-10-50
12 x 12	130	630-12	640-12
12 x 12	90	630-12-90	640-12-90
12.7 x 12.7	130	630-12.7	640-12.7
16 x 16	130	630-16	640-16
16 x 16	75	630-16-75	640-16-75
20 x 20	120	630-20	640-20

Chaque support est livré avec vis et clé.
 Jeder Halter wird mit Spannschraube(n) und Schlüssel geliefert.
 Screw(s) and key are included with each tool holder.

Porte-outils avec arrosage intégré
 Halter mit integrierter Kühlmittelzufuhr
 Holders with integrated coolant supply

630-JET / 640-JET

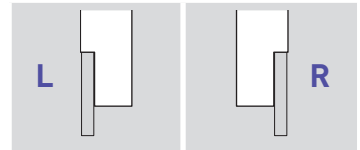
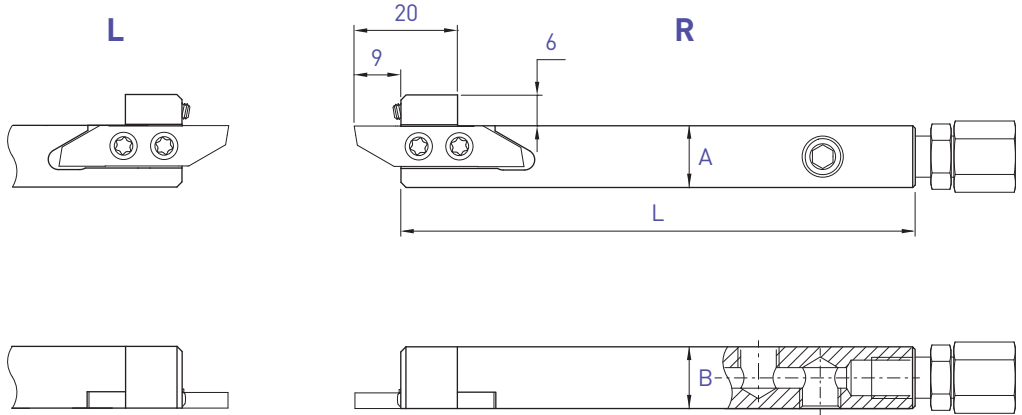

A x B	L	Art. N°	Art. N°
10 x 12	100	630-1012-JET	640-1012-JET
12 x 12	100	630-12-JET	640-12-JET
12.7 x 12.7	100	630-12.7-JET	640-12.7-JET
16 x 16	100	630-16-JET	640-16-JET
20 x 20	100	630-20-JET	640-20-JET

Chaque support est livré avec vis, clé, raccord droit et buse d'arrosage Ø 1.5 mm.
 Jeder Halter wird mit Spannschraube(n), Schlüssel, gerader Kühlmittelanschluss und Kühlmitteldüse Ø 1.5 mm geliefert.
 Screw(s), key, straight connector and coolant nozzle Ø 1.5 mm are included with each tool holder.

PRO-LINE

Tournage avant
Vorwärts drehen
Front turning

632 / 642

L

R

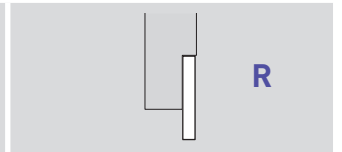
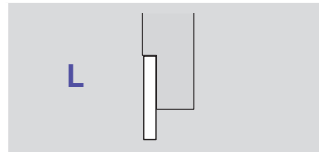
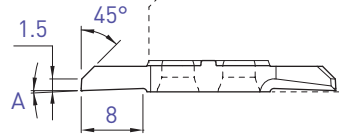
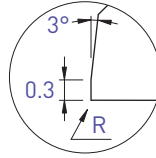
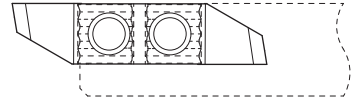
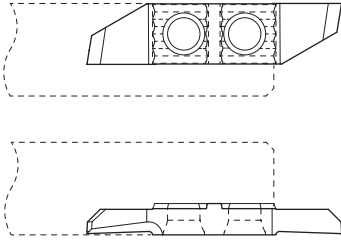

A	R	Art. N°	TiAlN N [µk20]	HTA HN [µk10]	Art. N°	TiAlN N [µk20]	HTA HN [µk10]
0°	0	632	■ ■		642	■ ■	□ □
0°	0.08	-			642-R08	■ ■	□ □
0°	0.15	-			642-R15	■ ■	□ □
2°	0	632-2°	■ ■		642-2°	■ ■	□ □
2°	0.08	-			642-2°-R08	■ ■	□ □
2°	0.15	-			642-2°-R15	■ ■	□ □

Tournage avant
Vorwärts drehen
Front turning

632X / 642X

L

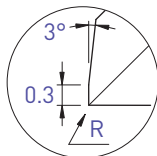
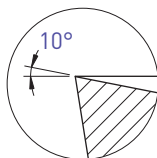
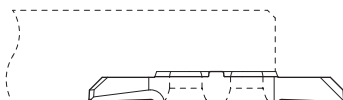
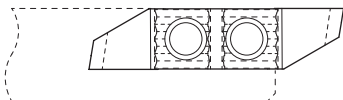

R

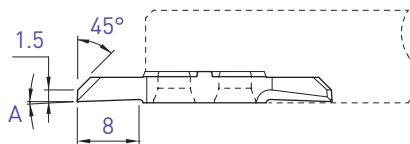
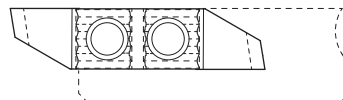

L



R



A	R	Art. N°	TiAlN N [µk20]	HTA HN [µk10]	Art. N°	TiAlN N [µk20]	HTA HN [µk10]
0°	0	632X10	■ ■		642X10	■ ■	□ □
0°	0.08	-			642X10-R08	■ ■	□ □
0°	0.15	-			642X10-R15	■ ■	□ □
2°	0	632X10-2°	■ ■		642X10-2°	■ ■	□ □
2°	0.08	-			642X10-2°-R08	■ ■	□ □
2°	0.15	-			642X10-2°-R15	■ ■	□ □

Tournage multifonction

Mehrweck drehen

Multifunction turning

632S / 642S

L

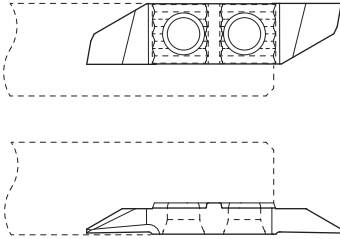

R

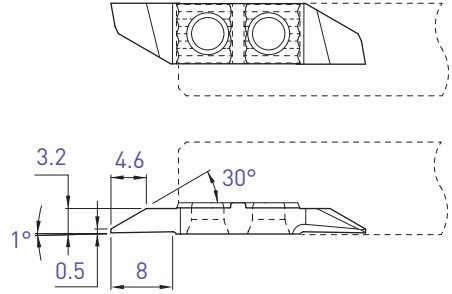

Tournage avant
Vorwärts drehen
Front turning

L				R			
Art. N°	TiAlN N (µk20)	HTA	HN (µk10)	Art. N°	TiAlN N (µk20)	HTA	HN (µk10)
632S05	■ ■			642S05	■ ■	□ □	

Tournage multifonction

Mehrweck drehen

Multifunction turning

633S / 643S

L

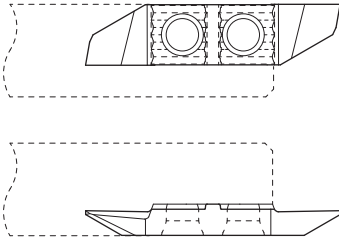

R

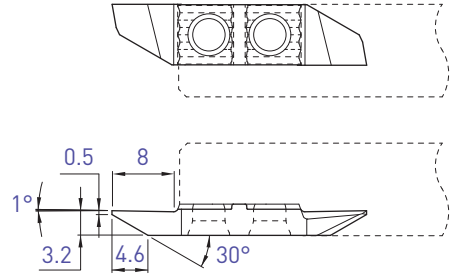

Tournage arrière
Rückwärts drehen
Back turning

L				R			
Art. N°	TiAlN N [µk20]	HTA	HN [µk10]	Art. N°	TiAlN N [µk20]	HTA	HN [µk10]
633S05	■ ■			643S05	■ ■	□ □	

L

R

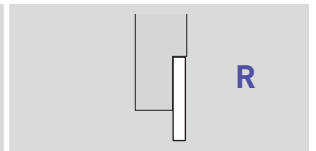
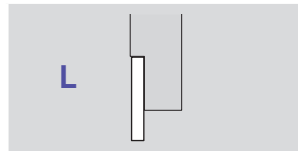
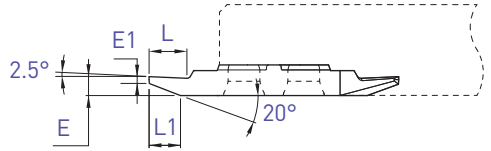
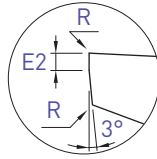
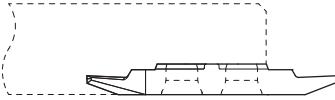
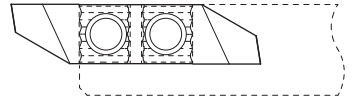
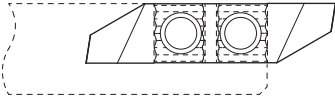

E1	E2	L	L1	E	R	Art. N°	TiAlN N [µk20]	HTA HN [µk10]	Art. N°	TiAlN N [µk20]	HTA HN [µk10]
0.5	0.25	3	2.8	1.5	0	633-0.5	■ ■		643-0.5	■ ■	□ □
0.5	0.25	3	2.8	1.5	0.08	-			643-0.5-R08	■ ■	□ □
0.8	0.40	4.5	3.3	2.0	0	-			643-0.8	■ ■	□ □
0.8	0.40	4.5	3.3	2.0	0.08	-			643-0.8-R08	■ ■	□ □
1.0	0.40	5	4.2	2.5	0	-			643-1.0	■ ■	□ □
1.0	0.40	5	4.2	2.5	0.08	-			643-1.0-R08	■ ■	□ □
1.5	0.50	6	4.2	3.0	0	-			643-1.5	■ ■	□ □
1.5	0.50	6	4.2	3.0	0.08	-			643-1.5-R08	■ ■	□ □

Tournage arrière
 Rückwärts drehen
 Back turning

633X / 643X

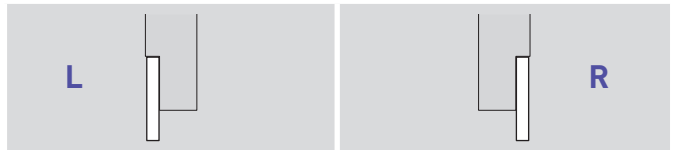
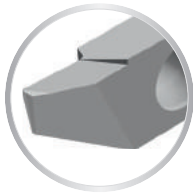
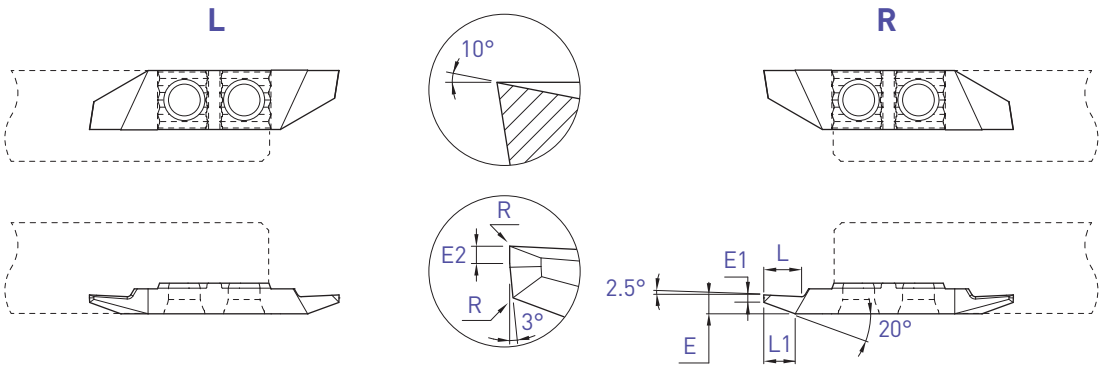

E1	E2	L	L1	E	R	Art. N°	TiAlN N (µk20)	HTA HN (µk10)	Art. N°	TiAlN N (µk20)	HTA HN (µk10)
0.5	0.25	3	2.8	1.5	0	633X10-0.5	■ ■		643X10-0.5	■ ■	□ □
0.5	0.25	3	2.8	1.5	0.08	-			643X10-0.5-R08	■ ■	□ □
0.8	0.40	4.5	3.3	2.0	0	-			643X10-0.8	■ ■	□ □
0.8	0.40	4.5	3.3	2.0	0.08	-			643X10-0.8-R08	■ ■	□ □
1.0	0.40	5	4.2	2.5	0	-			643X10-1.0	■ ■	□ □
1.0	0.40	5	4.2	2.5	0.08	-			643X10-1.0-R08	■ ■	□ □
1.5	0.50	6	4.2	3.0	0	-			643X10-1.5	■ ■	□ □
1.5	0.50	6	4.2	3.0	0.08	-			643X10-1.5-R08	■ ■	□ □

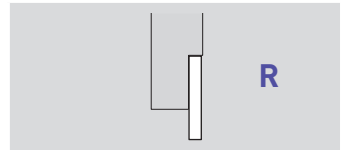
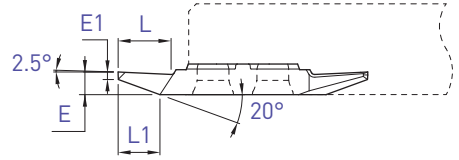
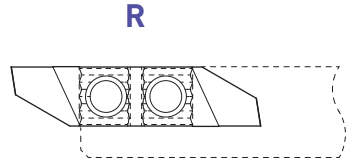
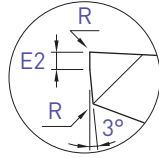
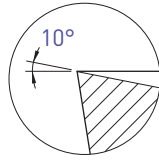

E1	E2	L	L1	E	R	Art. N°	TiAlN N [µk20]	HTA	HN [µk10]
1.0	0.4	7	5.5	3.0	0	643X10S-1.0	■ ■	□ □	
1.0	0.4	7	5.5	3.0	0.08	643X10S-1.0-R08	■ ■	□ □	

Tournage arrière
 Rückwärts drehen
 Back turning

643VX8

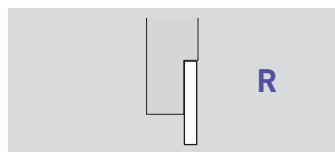
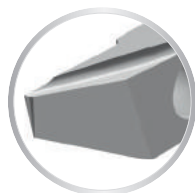
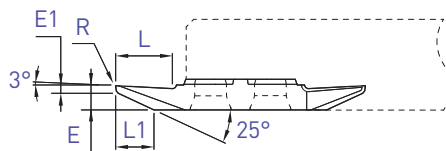
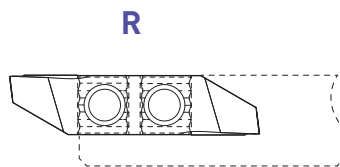
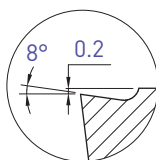

E1	L	L1	E	R	Art. N°	TiAlN N [µk20]	HTA	HN [µk10]
1.0	7.5	5.0	3.2	0	643VX8	■ ■	□ □	
1.0	7.5	5.0	3.2	0.08	643VX8-R08	■ ■	□ □	

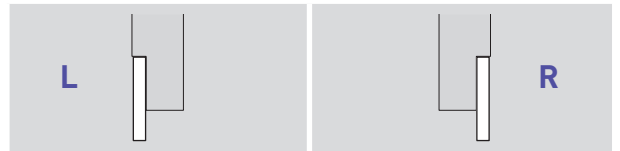
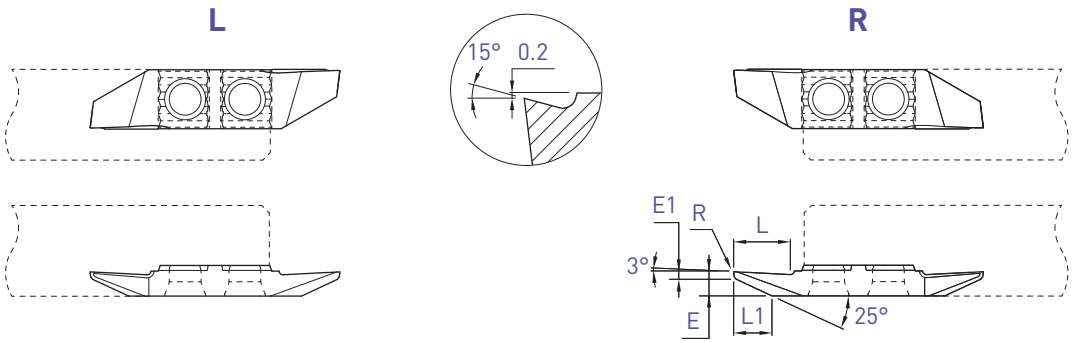

E1	L	L1	E	R	Art. N°	TiAlN N [µk20]	HTA HN [µk10]	Art. N°	TiAlN N [µk20]	HTA HN [µk10]
0.6	7.5	5.2	3.2	0	633VX15	■ ■		643VX15	■ ■	□ □
0.6	7.5	5.2	3.2	0.08	-			643VX15-R08	■ ■	□ □

Tournage arrière
 Rückwärts drehen
 Back turning

643VUX

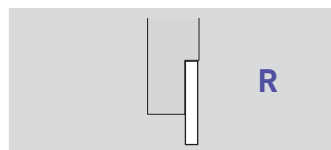
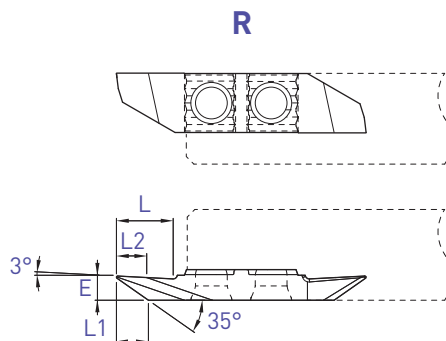
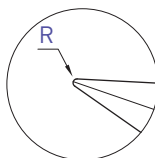
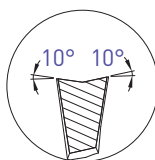

L	L1	L2	E	R	Art. N°	TiAlN N [µk20]	HTA	HN [µk10]
7.5	4.2	4.0	3.2	0.15	643VUX10-R15	■ ■	□ □	
7.5	3.8	3.8	3.2	0.35	643VUX10-R35	■ ■	□ □	

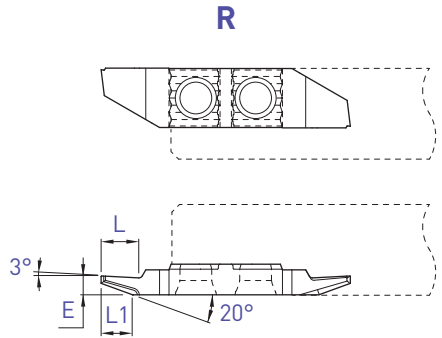
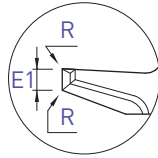
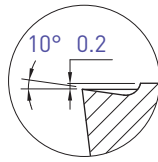

Pour un meilleur contrôle des copeaux
Für eine bessere Spankontrolle
For a better chip control

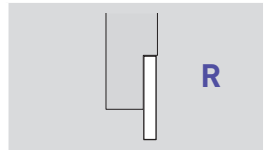

E1	L	L1	E	R	Art. N°	TiAlN N (µk20)
1.0	5	4	2.5	0.01	643ZX10-1.0	■
1.0	5	4	2.5	0.08	643ZX10-1.0-R08	■

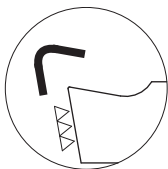

Arête de coupe honée
Gehonte Schneidkante
Honed edge

f min: 0.02 mm/U

Fonçage-tournage

Einstecken und drehen

Grooving and turning

634 / 644

L

R

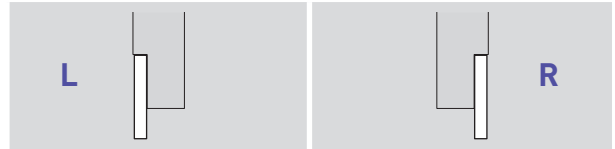
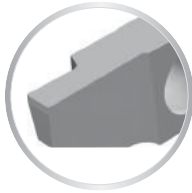
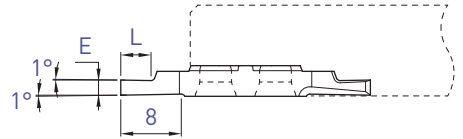
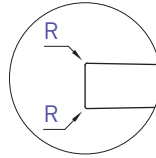
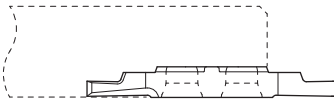
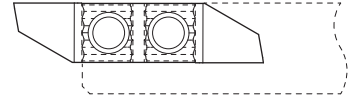
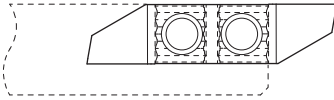

E	L	R	Art. N°	TiAlN N (µk20)	HTA HN (µk10)	Art. N°	TiAlN N (µk20)	HTA HN (µk10)
0.5	1.5	0	634-0.5	■ ■		644-0.5	■ ■	□ □
0.6	1.8	0	-			644-0.6	■ ■	□ □
0.75	2	0	-			644-0.75	■ ■	□ □
0.8	2	0	634-0.8	■ ■		644-0.8	■ ■	□ □
0.9	2.5	0	-			644-0.9	■ ■	□ □
0.95	3	0	-			644-0.95	■ ■	□ □
1.0	2.5	0	634-1.0	■ ■		644-1.0	■ ■	□ □
1.0	2.5	0.08	-			644-1.0-R08	■ ■	□ □
1.2	3	0	634-1.2	■ ■		644-1.2	■ ■	□ □
1.2	3	0.08	-			644-1.2-R08	■ ■	□ □
1.5	3	0	634-1.5	■ ■		644-1.5	■ ■	□ □
1.5	3	0.08	-			644-1.5-R08	■ ■	□ □
1.5	3	0.15	-			644-1.5-R15	■ ■	□ □
1.8	4	0	-			644-1.8	■ ■	□ □
2.0	4	0	634-2.0	■ ■		644-2.0	■ ■	□ □
2.0	4	0.08	-			644-2.0-R08	■ ■	□ □
2.0	4	0.15	-			644-2.0-R15	■ ■	□ □
2.5	6	0	634-2.5	■ ■		644-2.5	■ ■	□ □
2.5	6	0.08	-			644-2.5-R08	■ ■	□ □
2.5	6	0.15	-			644-2.5-R15	■ ■	□ □
3	6	0	634-3.0	■ ■		644-3.0	■ ■	□ □
3	6	0.08	-			644-3.0-R08	■ ■	□ □
3	6	0.15	-			644-3.0-R15	■ ■	□ □

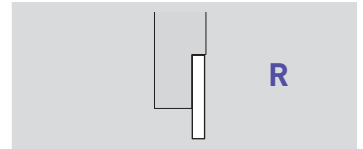
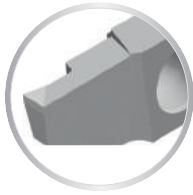
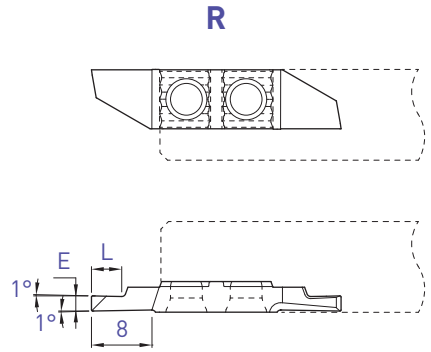
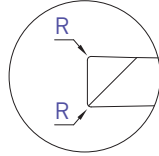
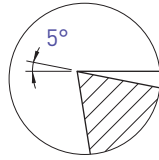

E	L	R	Art. N°	TiAlN	N (µk20)	HTA	HN (µk10)
1.5	3	0.08	644X5-1.5-R08	■	■	□	□
2	4	0.08	644X5-2.0-R08	■	■	□	□
2	4	0.15	644X5-2.0-R15	■	■	□	□
2.5	6	0.08	644X5-2.5-R08	■	■	□	□
2.5	6	0.15	644X5-2.5-R15	■	■	□	□
3	6	0.08	644X5-3.0-R08	■	■	□	□
3	6	0.15	644X5-3.0-R15	■	■	□	□

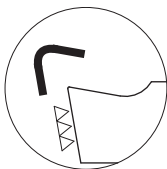
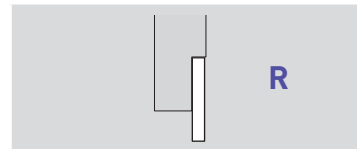

Arête de coupe honée
 Gehonte Schneidkante
 Honed edge

f min: 0.02 mm/U

E	L	R	Art. N°	TiAlN	N (µk20)	HTA	HN (µk10)
1.5	3	0.08	644X5-1.5-R08-EP	■	■		
2	4	0.08	644X5-2.0-R08-EP	■	■		
2	4	0.15	644X5-2.0-R15-EP	■	■		
2.5	6	0.08	644X5-2.5-R08-EP	■	■		
2.5	6	0.15	644X5-2.5-R15-EP	■	■		
3	6	0.08	644X5-3.0-R08-EP	■	■		
3	6	0.15	644X5-3.0-R15-EP	■	■		

Fonçage-tournage

Einstecken und drehen

Grooving and turning

634X10 / 644X10

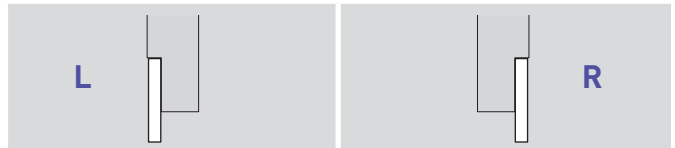
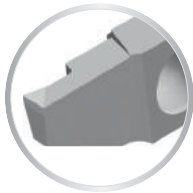
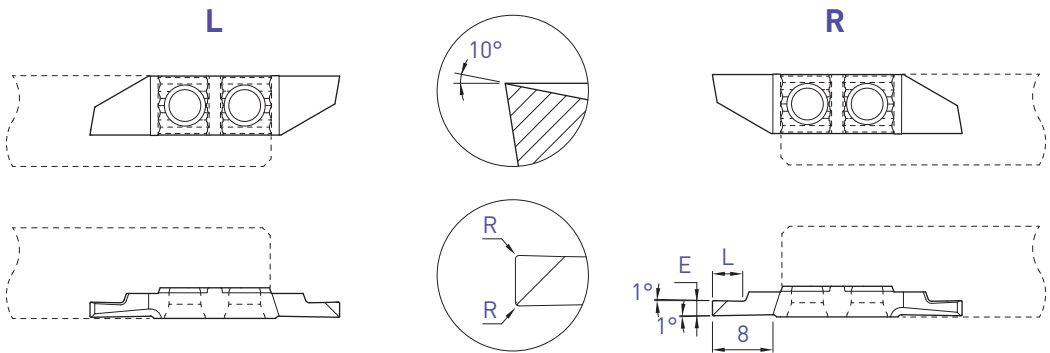

			L				R			
E	L	R	Art. N°	TiAlN N (µk20)	HTA HN (µk10)	Art. N°	TiAlN N (µk20)	HTA HN (µk10)		
0.8	2	0	634X10-0.8	■ ■		644X10-0.8	■ ■	□ □		
1.0	2.5	0	634X10-1.0	■ ■		644X10-1.0	■ ■	□ □		
1.0	2.5	0.08	634X10-1.0-R08	■ ■		644X10-1.0-R08	■ ■	□ □		
1.2	3	0	-			644X10-1.2	■ ■	□ □		
1.2	3	0.08	-			644X10-1.2-R08	■ ■	□ □		
1.5	3	0	634X10-1.5	■ ■		644X10-1.5	■ ■	□ □		
1.5	3	0.08	634X10-1.5-R08	■ ■		644X10-1.5-R08	■ ■	□ □		
1.5	3	0.15	634X10-1.5-R15	■ ■		644X10-1.5-R15	■ ■	□ □		
1.8	4	0	-			644X10-1.8	■ ■	□ □		
2	4	0	634X10-2.0	■ ■		644X10-2.0	■ ■	□ □		
2	4	0.08	634X10-2.0-R08	■ ■		644X10-2.0-R08	■ ■	□ □		
2	4	0.15	634X10-2.0-R15	■ ■		644X10-2.0-R15	■ ■	□ □		
2.5	6	0	634X10-2.5	■ ■		644X10-2.5	■ ■	□ □		
2.5	6	0.08	634X10-2.5-R08	■ ■		644X10-2.5-R08	■ ■	□ □		
2.5	6	0.15	634X10-2.5-R15	■ ■		644X10-2.5-R15	■ ■	□ □		
3	6	0	634X10-3.0	■ ■		644X10-3.0	■ ■	□ □		
3	6	0.08	634X10-3.0-R08	■ ■		644X10-3.0-R08	■ ■	□ □		
3	6	0.15	634X10-3.0-R15	■ ■		644X10-3.0-R15	■ ■	□ □		

■ = disponible / verfügbar / available
 □ = selon disponibilité du stock / jenach Lagerverfügbarkeit / depending on stock availability

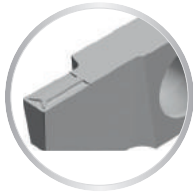
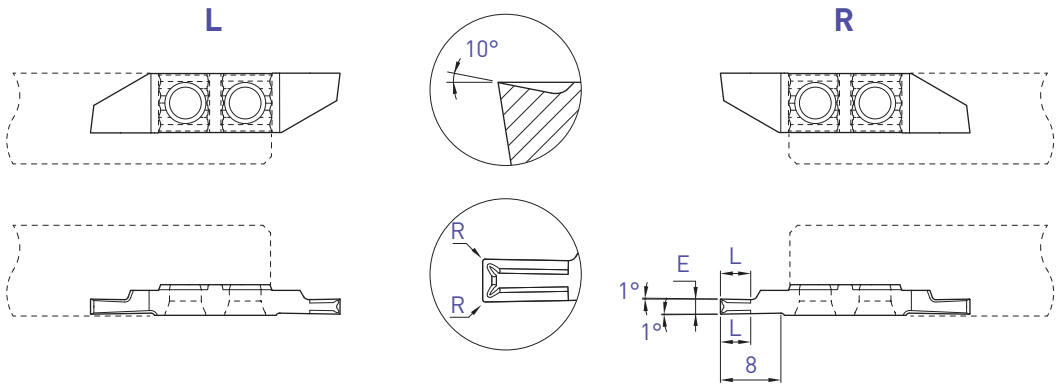

Pour un meilleur contrôle des copeaux
Für eine bessere Spankontrolle
For a better chip-control

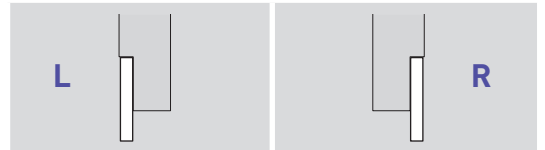

E	L	R	Art. N°	TiAlN N (µk20)	Art. N°	TiAlN N (µk20)
1.0	2.5	0.01	634ZXB10-1.0	■	644ZXB10-1.0	■
1.5	4	0.01	634ZXB10-1.5	■	644ZXB10-1.5	■
1.5	4	0.08	634ZXB10-1.5-R08	■	644ZXB10-1.5-R08	■
2.0	4	0.01	634ZXB10-2.0	■	644ZXB10-2.0	■
2.0	4	0.08	634ZXB10-2.0-R08	■	644ZXB10-2.0-R08	■
2.0	4	0.15	634ZXB10-2.0-R15	■	644ZXB10-2.0-R15	■
2.5	5	0.08	634ZXB10-2.5-R08	■	644ZXB10-2.5-R08	■
2.5	5	0.15	634ZXB10-2.5-R15	■	644ZXB10-2.5-R15	■
3.0	6	0.08	634ZXB10-3.0-R08	■	644ZXB10-3.0-R08	■
3.0	6	0.15	634ZXB10-3.0-R15	■	644ZXB10-3.0-R15	■
3.0	6	0.35	634ZXB10-3.0-R35	■	644ZXB10-3.0-R35	■

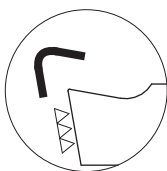

Arête de coupe honée
Gehonte Schneidkante
Honed edge

f min: 0.02 mm/U

Fonçage-tournage

Einstecken und drehen

Grooving and turning

634ZXT / 644ZXT

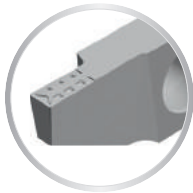
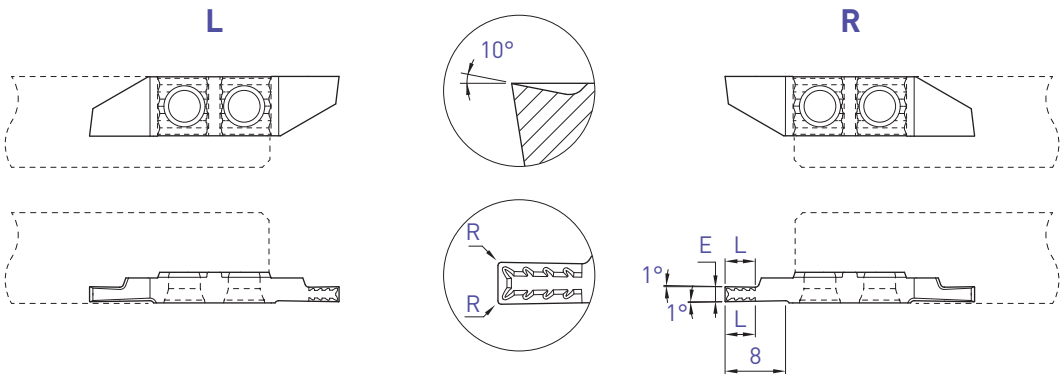

Pour un meilleur contrôle des copeaux
Für eine bessere Spankontrolle
For a better chip-control

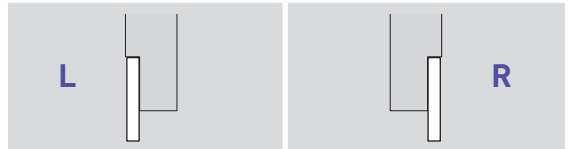

E	L	R	Art. N°	TiAlN N (µm20)	Art. N°	TiAlN N (µm20)
1.0	2.5	0.01	634ZXT10-1.0	■	644ZXT10-1.0	■
1.5	4	0.01	634ZXT10-1.5	■	644ZXT10-1.5	■
1.5	4	0.08	634ZXT10-1.5-R08	■	644ZXT10-1.5-R08	■
2.0	4	0.01	634ZXT10-2.0	■	644ZXT10-2.0	■
2.0	4	0.08	634ZXT10-2.0-R08	■	644ZXT10-2.0-R08	■
2.0	4	0.15	634ZXT10-2.0-R15	■	644ZXT10-2.0-R15	■
2.5	5	0.08	634ZXT10-2.5-R08	■	644ZXT10-2.5-R08	■
2.5	5	0.15	634ZXT10-2.5-R15	■	644ZXT10-2.5-R15	■
3.0	6	0.08	634ZXT10-3.0-R08	■	644ZXT10-3.0-R08	■
3.0	6	0.15	634ZXT10-3.0-R15	■	644ZXT10-3.0-R15	■
3.0	6	0.35	-		644ZXT10-3.0-R35	■



Arête de coupe honée
Gehonte Schneidkante
Honed edge

f min: 0.02 mm/U

L

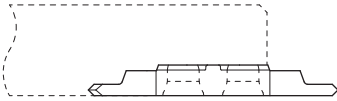
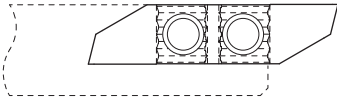

R

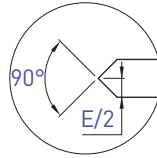
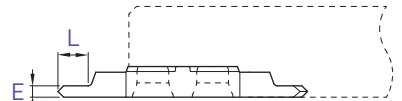
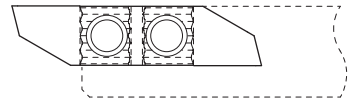

L



R



E	L	Art. N°	TiAlN N (µk20)	Art. N°	TiAlN N (µk20)
1.5	4	635-90-1.5	■ ■	645-90-1.5	■ ■

Chanfreinage

Anfasen

Chamfering

635X-90 / 645X-90

L

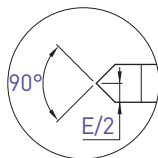
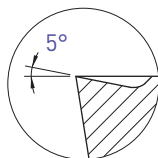
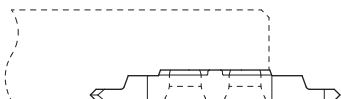
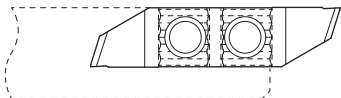

R

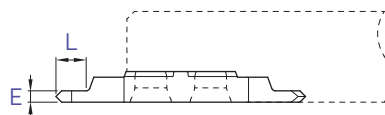
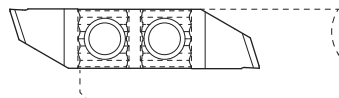

L



R



E	L	Art. N°	TiAlN N (µk<20)	Art. N°	TiAlN N (µk<20)
1.5	4	635X5-90-1.5	■ ■	645X5-90-1.5	■ ■

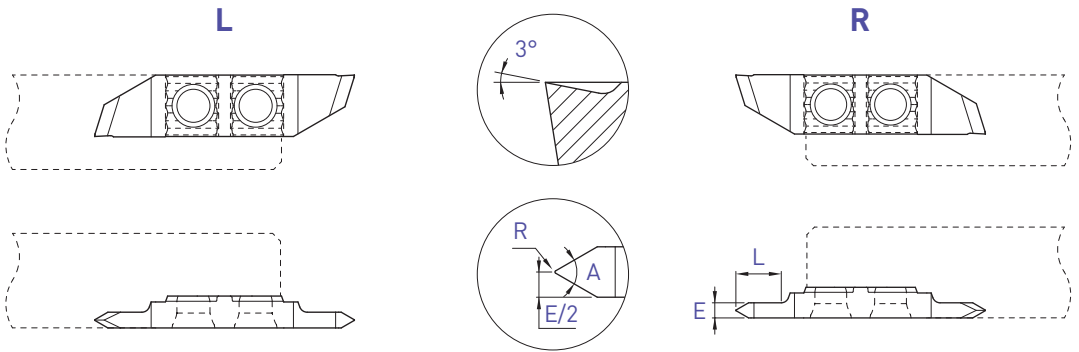

Profil partiel
Teilprofil
Partial profile

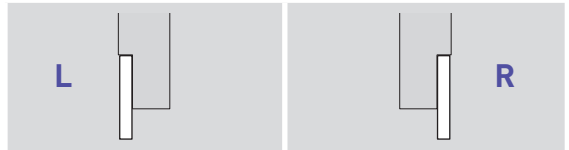

A	E	L	R	Art. N°	TiAlN N (µk20)	Art. N°	TiAlN N (µk20)
55°	1.5	4	0	636X3-55-1.5	■ ■	646X3-55-1.5	■ ■
55°	2.0	6	0.03	636X3-55-2.0-R03	■ ■	646X3-55-2.0-R03	■ ■
60°	1.5	4	0	636X3-60-1.5	■ ■	646X3-60-1.5	■ ■
60°	2.0	6	0.03	636X3-60-2.0-R03	■ ■	646X3-60-2.0-R03	■ ■
60°	2.0	6	0.06	636X3-60-2.0-R06	■ ■	646X3-60-2.0-R06	■ ■
60°	3.0	8	0.06	636X3-60-3.0-R06	■ ■	646X3-60-3.0-R06	■ ■
60°	3.0	8	0.12	636X3-60-3.0-R12	■ ■	646X3-60-3.0-R12	■ ■

Filetage

Gewinde drehen

Threading

636X-M / 646X-M

L

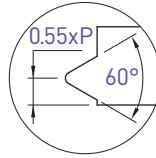
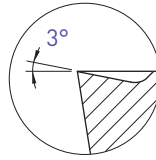
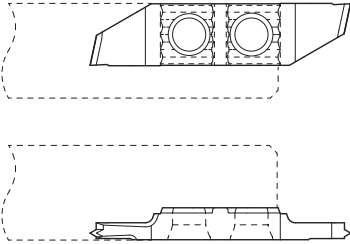

R

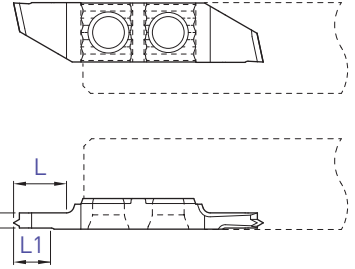

Profil complet métrique
Metrisches Vollprofil
Metric full profile

L



R



E	L	L1	Pas Steigung Pitch P	Art. N°	TiAlN N (µk20)	Art. N°	TiAlN N (µk20)
1.0	3	3	0.25	636X3-M-0.25	■ ■	646X3-M-0.25	■ ■
1.0	3	3	0.30	636X3-M-0.30	■ ■	646X3-M-0.30	■ ■
1.0	3	3	0.35	636X3-M-0.35	■ ■	646X3-M-0.35	■ ■
1.0	3	3	0.40	636X3-M-0.40	■ ■	646X3-M-0.40	■ ■
1.0	3	3	0.45	636X3-M-0.45	■ ■	646X3-M-0.45	■ ■
1.0	3	3	0.50	636X3-M-0.50	■ ■	646X3-M-0.50	■ ■
1.5	5	5	0.60	636X3-M-0.60	■ ■	646X3-M-0.60	■ ■
1.5	5	5	0.70	636X3-M-0.70	■ ■	646X3-M-0.70	■ ■
1.5	5	5	0.75	636X3-M-0.75	■ ■	646X3-M-0.75	■ ■
1.5	5	5	0.80	636X3-M-0.80	■ ■	646X3-M-0.80	■ ■
2.0	7	5	1.00	636X3-M-1.00	■ ■	646X3-M-1.00	■ ■
2.0	7	5	1.25	636X3-M-1.25	■ ■	646X3-M-1.25	■ ■
2.0	7	5	1.50	636X3-M-1.50	■ ■	646X3-M-1.50	■ ■

L

R

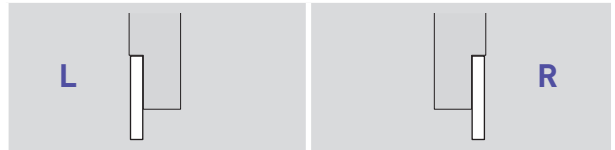
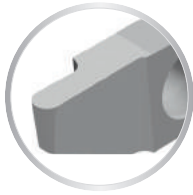
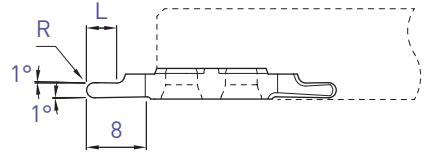
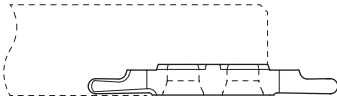
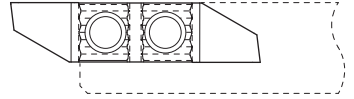
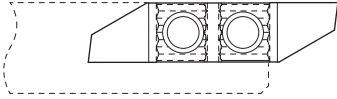

		L				R			
R	L	Art. N°	TiAlN N (µk20)	HTA HN (µk10)	Art. N°	TiAlN N (µk20)	HTA HN (µk10)		
0.25	1.5	-			647-R0.25	■ ■			
0.4	2	-			647-R0.4	■ ■			
0.5	2.5	637-R0.5	■ ■		647-R0.5	■ ■ □ □			
0.6	2.5	-			647-R0.6	■ ■			
0.75	3	-			647-R0.75	■ ■			
0.8	3	-			647-R0.8	■ ■			
1.0	4	637-R1.0	■ ■		647-R1.0	■ ■			
1.5	6	-			647-R1.5	■ ■			

Plaquettes à rayon
 Radius Wendplatten
 Radius inserts

647ZX10

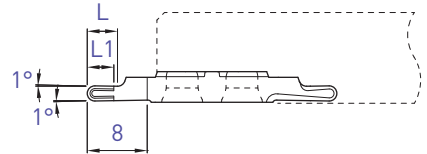
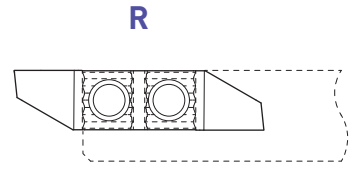
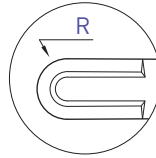
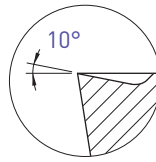

Pour un meilleur contrôle des copeaux
 Für eine bessere Spankontrolle
 For a better chip-control

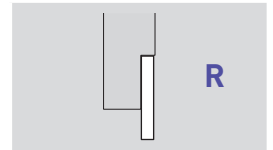

R	L	L1	Art. N°	TiAlN N (µk20)
1.0	4	3.5	647ZX10-R1.0	■
1.5	6	4	647ZX10-R1.5	■

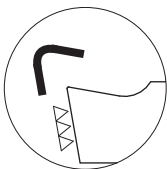

Arête de coupe honée
 Gehonte Schneidkante
 Honed edge

f min: 0.02 mm/U

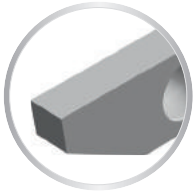
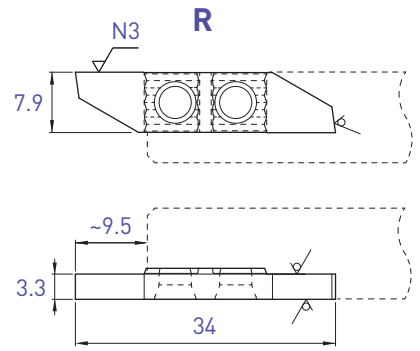
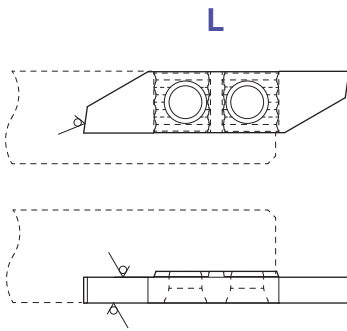

Face de coupe polie
 Polierte Schneidfläche
 Polished cutting face

L			R		
Art. N°	TiAlN N (µk20)	HTA HN (µk10)	Art. N°	TiAlN N (µk20)	HTA HN (µk10)
631-EP	■ ■	■ ■	641-EP	■ ■	■ ■

Porte-outils

Halter

Holder

650 / 660

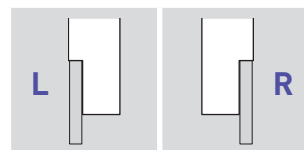
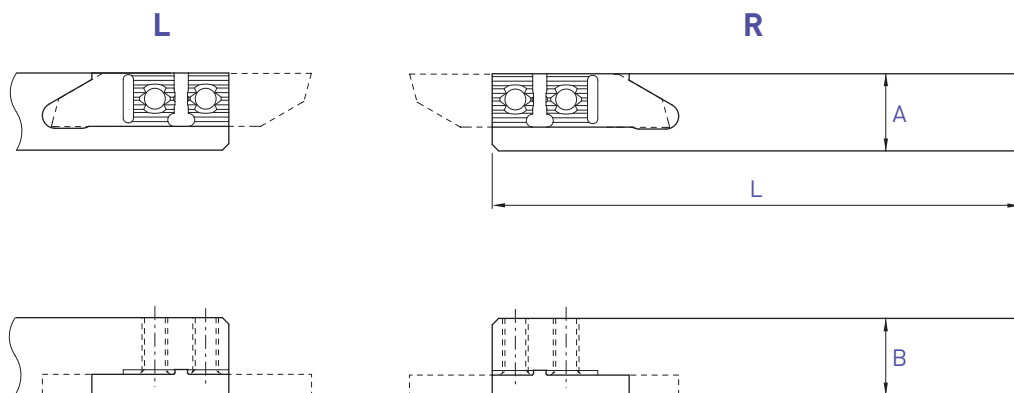

A x B	L	Art. N°	Art. N°
8 x 8	115	650-8	660-8
10 x 10	115	650-10	660-10
10 x 10	50	650-10-50	660-10-50
12 x 12	130	650-12	660-12
12 x 12	90	650-12-90	660-12-90
12.7 x 12.7	130	650-12.7	660-12.7
16 x 16	130	650-16	660-16
16 x 16	75	650-16-75	660-16-75
20 x 20	120	650-20	660-20

Chaque support est livré avec vis et clé.

Jeder Halter wird mit Spannschraube(n) und Schlüssel geliefert.

Screw(s) and key are included with each tool holder.

■ = disponible / verfügbar / available

□ = selon disponibilité du stock / jenach Lagerverfügbarkeit / depending on stock availability

Utiliser des plaquettes type 651R
 WSP Typ 651R verwenden
 Use inserts type 651R

Voir dès page 3.39
 Siehe ab Seite 3.39
 See from page 3.39

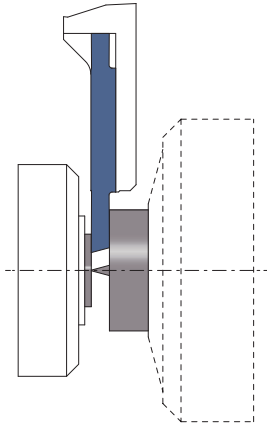
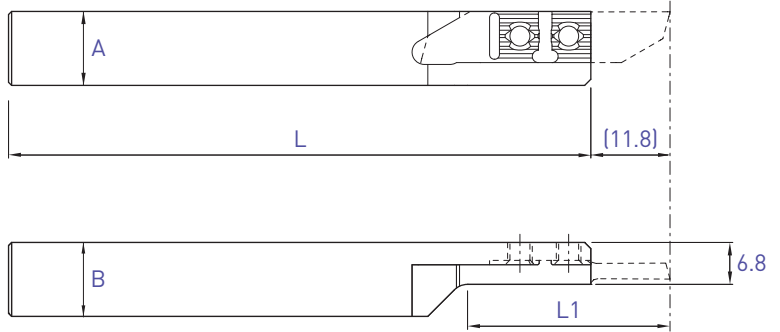

 L (R) Coupe à droite déportée Versetztes Rechtsschneiden Right cut off line			
A x B	L	L1	Art. N°
10 x 10	115	32	650RC-10
12 x 12	130	32	650RC-12
16 x 16	130	42	650RC-16

Chaque support est livré avec vis et clé.
 Jeder Halter wird mit Spannschraube(n) und Schlüssel geliefert.
 Screw(s) and key are included with each tool holder.

Porte-outils avec arrosage intégré
 Halter mit integrierter Kühlmittelzufuhr
 Holders with integrated coolant supply

650-JET / 660-JET

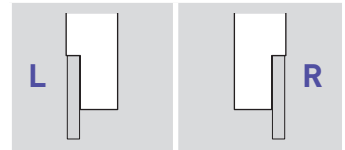
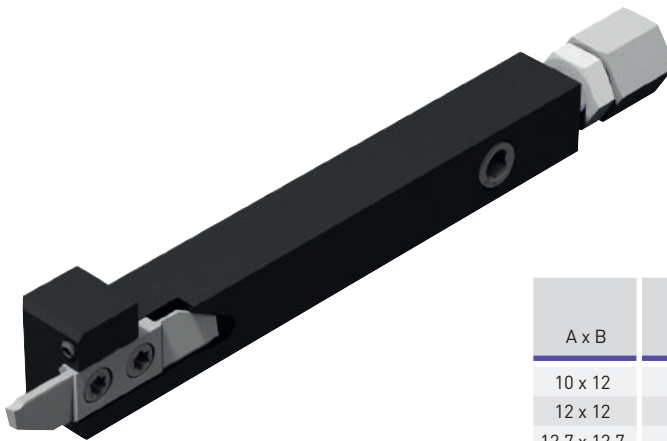
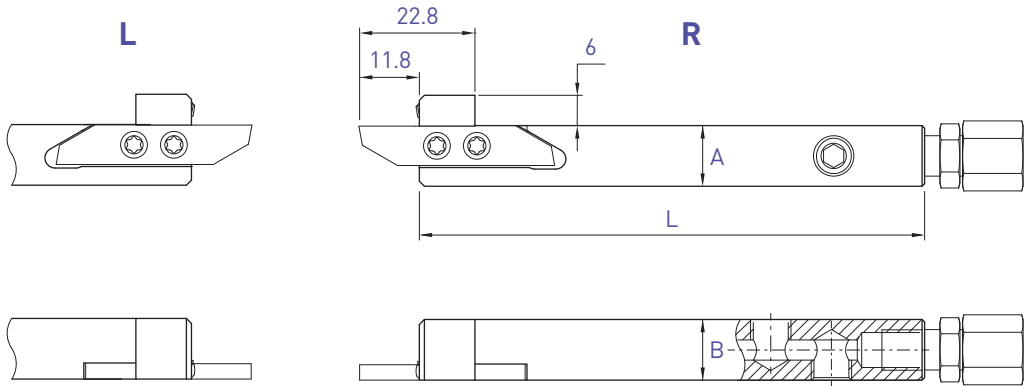

A x B	L	Art. N°	Art. N°
10 x 12	100	650-1012-JET	660-1012-JET
12 x 12	100	650-12-JET	660-12-JET
12.7 x 12.7	100	650-12.7-JET	660-12.7-JET
16 x 16	100	650-16-JET	660-16-JET
20 x 20	100	650-20-JET	660-20-JET

Chaque support est livré avec vis, clé, raccord droit et buse d'arrosage Ø 1.5 mm.
 Jeder Halter wird mit Spannschraube(n), Schlüssel, gerader Kühlmittelanschluss und Kühlmitteldüse Ø 1.5 mm geliefert.
 Screws(s), key, straight connector and coolant nozzle Ø 1.5 mm are included with each tool holder.

L

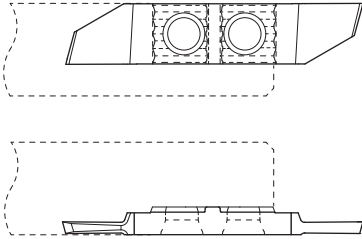

R

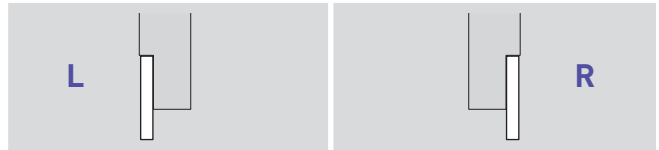
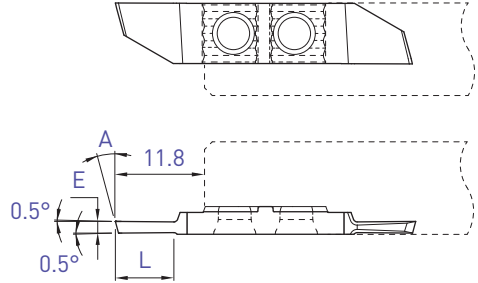

E	A	L	Art. N°	TiAlN N [µk20]	HTA HN [µk10]	Art. N°	TiAlN N [µk20]	HTA HN [µk10]
0.8	20°	5	651-0.8-20°	■ ■		661-0.8-20°	■ ■	□ □
1.0	15°	5	-			661-1.0-15°	■ ■	□ □
1.0	20°	5	651-1.0-20°	■ ■		661-1.0-20°	■ ■	□ □
1.2	15°	5	-			661-1.2-15°	■ ■	□ □
1.2	20°	5	651-1.2-20°	■ ■		661-1.2-20°	■ ■	□ □
1.5	15°	7.5	651-1.5-15°	■ ■		661-1.5-15°	■ ■	□ □
1.5	20°	7.5	-			661-1.5-20°	■ ■	□ □
1.8	15°	9	651-1.8-15°	■ ■		661-1.8-15°	■ ■	□ □
2.0	15°	11	651-2.0-15°	■ ■		661-2.0-15°	■ ■	□ □
2.5	15°	11	651-2.5-15°	■ ■		661-2.5-15°	■ ■	□ □

Tronçonnage

Abstechen

Parting off

651XF / 661XF

L

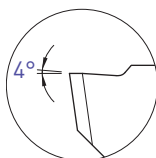
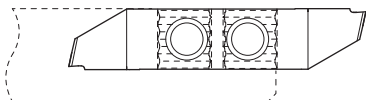

R

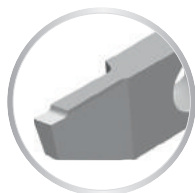
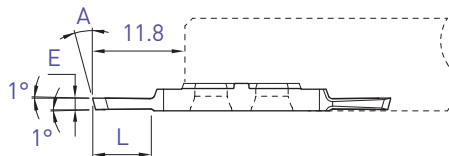
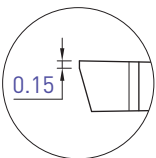
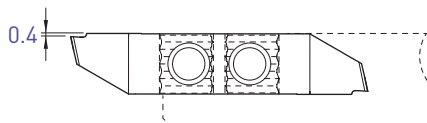

L



R



E	A	L	Art. N°	TiAlN N [µk20]	HTA HN [µk10]	Art. N°	TiAlN N [µk20]	HTA HN [µk10]
1.5	15°	7.5	651XF-1.5	■ ■		661XF-1.5	■ ■	□ □
2.0	15°	11	651XF-2.0	■ ■		661XF-2.0	■ ■	□ □

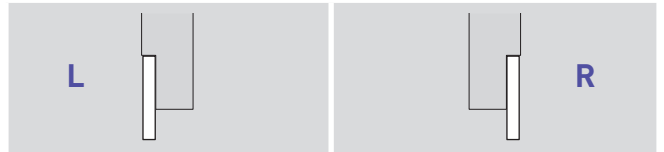
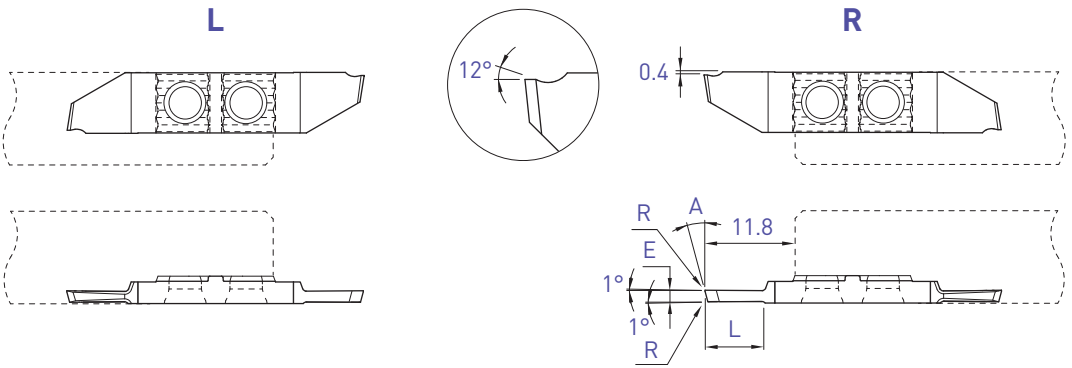

E	A	L	R	Art. N°	TiAlN N [µk20]	HTA HN [µk10]	Art. N°	TiAlN N [µk20]	HTA HN [µk10]
1.0	15°	5	0.03	651X12-1.0	■ ■		661X12-1.0	■ ■	□ □
1.5	15°	7.5	0.03	651X12-1.5	■ ■		661X12-1.5	■ ■	□ □
2.0	15°	11	0.03	651X12-2.0	■ ■		661X12-2.0	■ ■	□ □

Tronçonnage

Abstechen

Parting off

651U / 661U

L

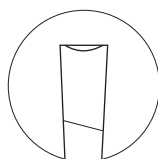
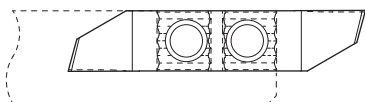

R

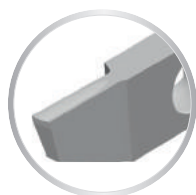
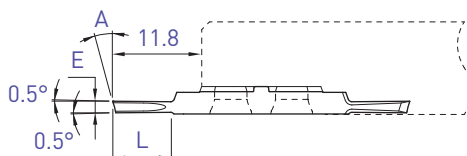
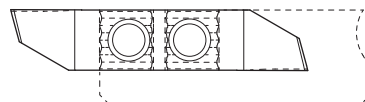

L

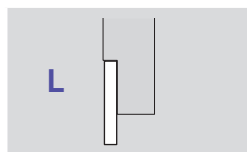

R

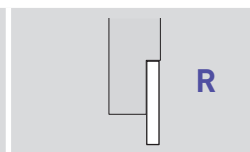

E	A	L	Art. N°	TiAlN N (µm20)	Art. N°	TiAlN N (µm20)
1.5	15°	7.5	651U-1.5	■ ■	661U-1.5	■ ■
2.0	15°	11	651U-2.0	■ ■	661U-2.0	■ ■

Tronçonnage

Abstechen

Parting off

661ZU

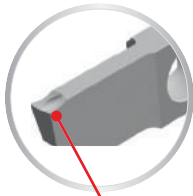
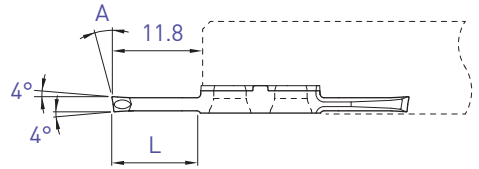
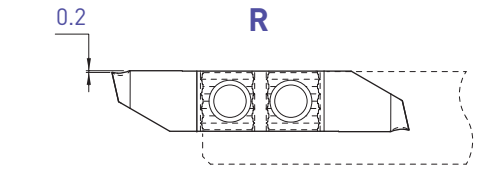
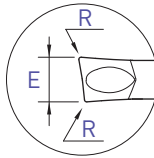
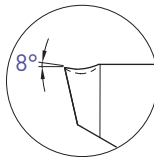

Pour un meilleur contrôle des copeaux
Für eine bessere Spankontrolle
For a better chip-control

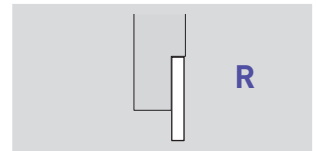
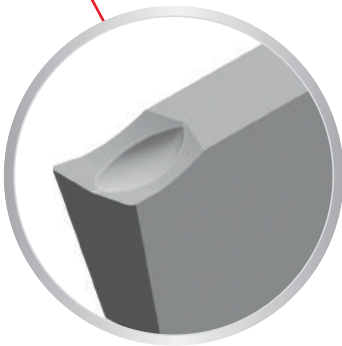

E	A	L	R	Art. N°	TiAlN N (µk20)
2.0	8°	11	0.10	661ZU8-2.0-8°-R10	■



Arête de coupe honée
Gehonte Schneidkante
Honed edge

f min: 0.02 mm/U

Tronçonnage
Abstechen
Parting off

Coupe déportée
Versetzttes Schneiden
Cut off line

651R

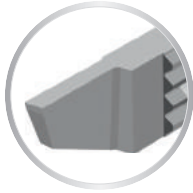

Cut R

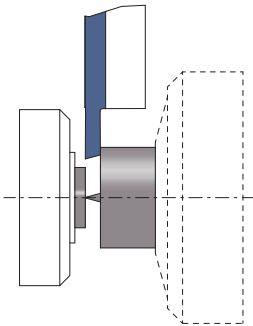
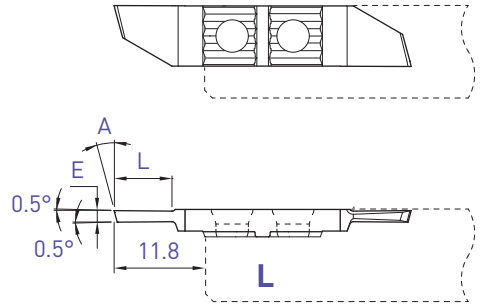

L (R)

Coupe à droite déportée
Versetzttes Rechtsschneiden
Right cut off line

E	A	L	Art. N°	Ti/AlN N (µk20)	HTA	HN (µk10)
1.0	15°	5	651R-1.0-15°	■ ■	□ □	
1.2	15°	5	651R-1.2-15°	■ ■	□ □	
1.5	15°	7.5	651R-1.5-15°	■ ■	□ □	
2.0	15°	11	651R-2.0-15°	■ ■	□ □	
2.5	15°	11	651R-2.5-15°	■ ■	□ □	

Tronçonnage
 Abstechen
 Parting off

Coupe déportée
 Versetztes Schneiden
 Cut off line

651RXF

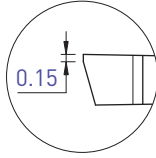
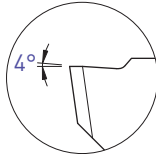
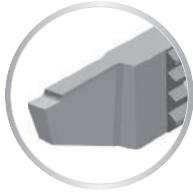

Cut R

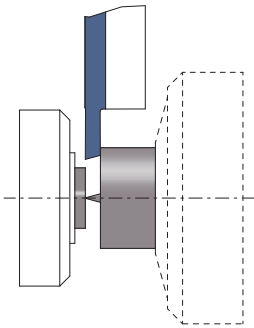
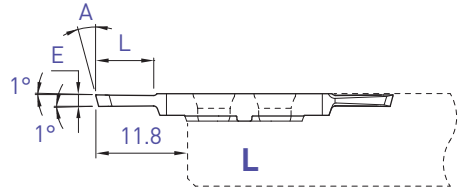
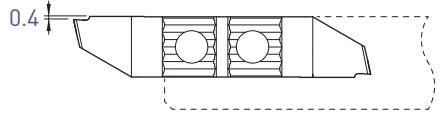

L (R)

Coupe à droite déportée
 Versetztes Rechtsschneiden
 Right cut off line

E	A	L	Art. N°	Ti/AlN N (µk20)	HTA	HN (µk10)
1.5	15°	7.5	651RXF-1.5	■ ■	□ □	
2.0	15°	11	651RXF-2.0	■ ■	□ □	

Tronçonnage
Abstechen
Parting off

Coupe déportée
Versetztes Schneiden
Cut off line

651RX12

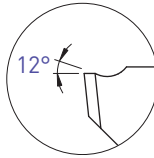
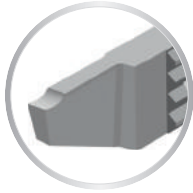

Cut R

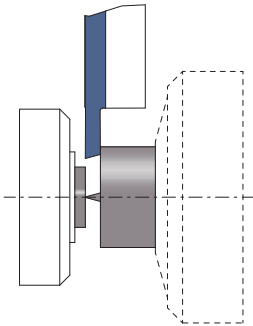
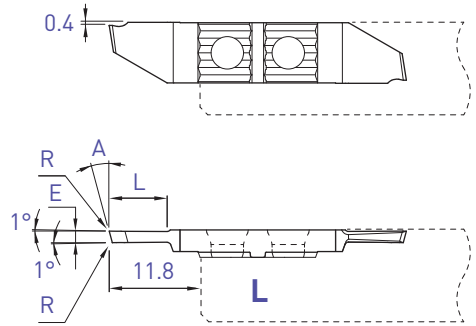

L (R)

Coupe à droite déportée
Versetztes Rechtsschneiden
Right cut off line

E	A	L	R	Art. N°	Ti/AIN N (µk20)	HTA	HN (µk10)
1.5	15°	7.5	0.03	651RX12-1.5	■ ■	□ □	
2.0	15°	11	0.03	651RX12-2.0	■ ■	□ □	

Tronçonnage
 Abstechen
 Parting off

Coupe déportée
 Versetztes Schneiden
 Cut off line

651RU

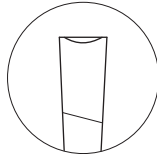

Cut R

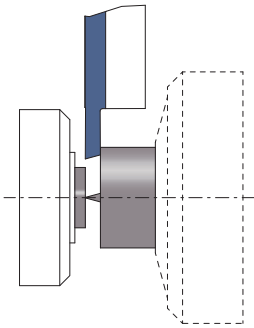
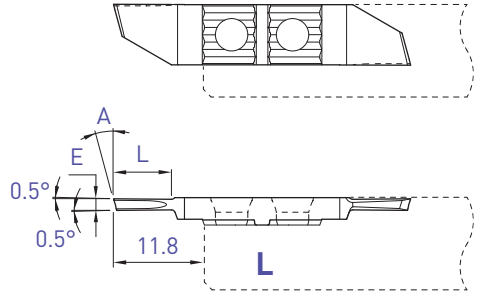

L (R)

Coupe à droite déportée
 Versetztes Rechtsschneiden
 Right cut off line

E	A	L	Art. N°	TiAlN N (µk20)
1.5	15°	7.5	651RU-1.5	■ ■
2.0	15°	11	651RU-2.0	■ ■

Tronçonnage
Abstechen
Parting off

Coupe déportée
Versetztes Schneiden
Cut off line

651RZU

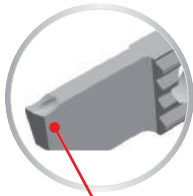
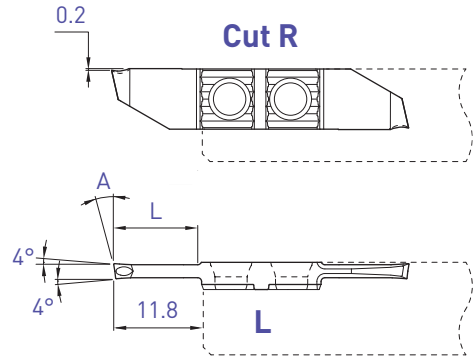
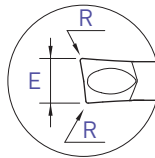
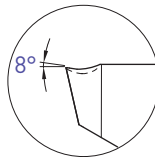

Pour un meilleur contrôle des copeaux
Für eine bessere Spankontrolle
For a better chip control

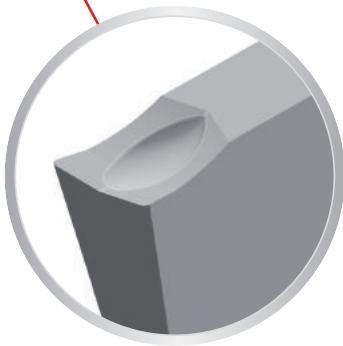

L (R)

Coupe à droite déportée
Versetztes Rechtsschneiden
Right cut off line

E	A	L	R	Art. N°	TiAlN N (µm20)
2.0	8°	11	0.10	651RZU8-2.0-8°-R10	■

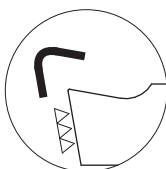

Arête de coupe honée
Gehonte Schneidkante
Honed edge

f min: 0.02 mm/U

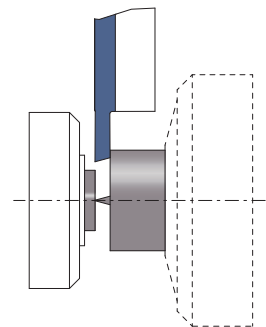

L

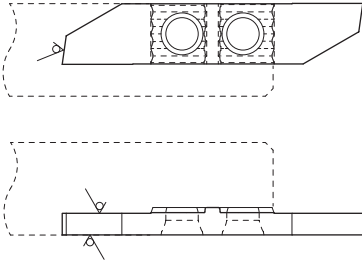

R

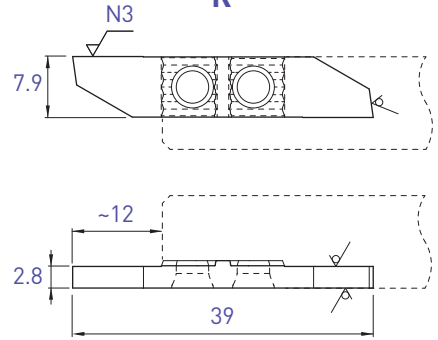





Face de coupe polie
 Polierte Schneidfläche
 Polished cutting face

L				R			
Art. N°	TiAlN N (µk20)	HTA	HN (µk10)	Art. N°	TiAlN N (µk20)	HTA	HN (µk10)
651-EP	■ ■	■ ■		661-EP	■ ■	■ ■	

Pièces de rechange et accessoires

Ersatzteile und Zubehör

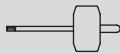
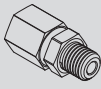
Spare parts and accessories

Pièces de rechange Ersatzteile Spare parts							
Porte-outils Halter Holders						Option Art. N°	Recommandation de serrage Drehmoment Empfehlung Clamping recommendation
630 640			-	-	-		
630-JET 640-JET	V-M4X9-T15		J-M8X1-D6	JB-M8X1	JJ-M3X6-D1.5		
650 660		C-T15	-	-	-	SET-NM-TX15	3 Nm
650-RC	V-M4X6.5-T15		-	-	-		
650-JET 660-JET	V-M4X9-T15		J-M8X1-D6	JB-M8X1	JJ-M3X6-D1.5		

■ = disponible / verfügbar / available

□ = selon disponibilité du stock / jenach Lagerverfügbarkeit / depending on stock availability



261

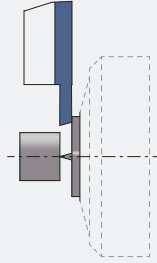

251R

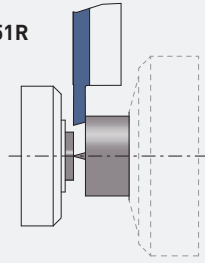

262

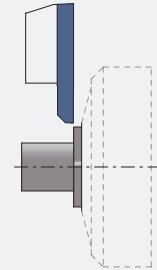

263

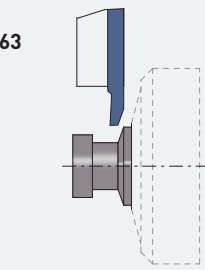

264

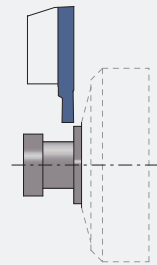

266

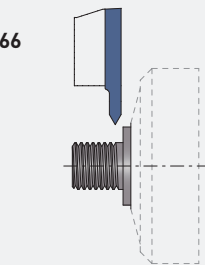

Index

Nuances
Sorten
Grades > 4.02

Paramètres de coupe indicatifs
Empfohlene Schnittwerte
Standard machining data > 4.03

Accessoires
Zubehör
Accessories

Porte-outils
Halter
Holders > 4.04

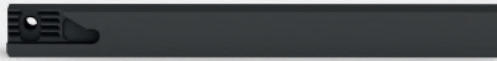

Tronçonnage
Abstechen
Parting off > 4.08

Type 251 / 261



Tournage avant
Vorwärts drehen
Front turning > 4.10

Type 252 / 262



Tournage arrière
Rückwärts drehen
Back turning > 4.11

Type 253 / 263



Fonçage-tournage
Einstechen und drehen
Grooving and turning > 4.14

Type 254 / 264



Filetage
Gewinde drehen
Threading > 4.16

Type 256 / 266



Plaquettes ébauches
WSP-Rohlinge
Blank inserts > 4.17

Type 251E / 261E



Usinage axial
Axiale Bearbeitung
Axial machining > 4.18 **new**

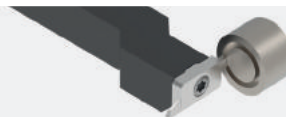

AP302

μK20 + revêtement PVD
μK20 + PVD Beschichtung
μK20 + PVD coating

- excellente nuance universelle
- 1^{er} choix pour l'usinage des aciers, aciers inoxydables et alliages de titane
- très bonne résistance à la température

- beste Universalsorte
- für die Bearbeitung von Stahl, rostfreiem Stahl und Titanlegierungen bestens geeignet
- sehr gute Warmfestigkeit

- best universal grade
- first choice for steel, stainless steel and titanium alloys machining
- very good heat resistance

AP202

μK20 + revêtement PVD
μK20 + PVD Beschichtung
μK20 + PVD coating

- nuance particulièrement adaptée aux faibles vitesses de coupe

- besonders geeignete Sorte für niedrige Schnittgeschwindigkeiten

- grade particularly suitable for low cutting speeds

N (μK20)

non revêtu
unbeschichtet
uncoated

- nuance micro-grain tenace
- supporte les coupes interrompues et autres conditions d'usinage défavorables

- zähe Feinkornsorte
- für unterbrochene Schnitte und andere ungünstige Bearbeitungsbedingungen geeignet

- tough micro-grain grade
- suitable for interrupted cut and other unfavourable machining conditions

AH302

μK10 + revêtement PVD
μK10 + PVD Beschichtung
μK10 + PVD coating

- nuance très résistante à l'usure
- pour l'usinage en finition dans des conditions favorables des aciers, aciers inoxydables et alliages de titane

- sehr verschleißfeste Sorte
- für die Feinbearbeitung von Stahl, rostfreiem Stahl und Titanlegierungen bei guten Bearbeitungsbedingungen

- very wear resistant grade
- for light machining of steel, stainless steel and titanium alloys under favourable machining conditions

HN (μK10)

non revêtu
unbeschichtet
uncoated

- nuance micro-grain très résistante à l'usure
- recommandé pour l'usinage du titane faiblement allié
- déconseillé en cas de coupe interrompue et autres conditions d'usinage défavorables

- verschleißfeste Feinkornsorte
- für die Bearbeitung von niedrig legiertem Titan empfehlenswert
- für unterbrochene Schnitte und andere ungünstige Bearbeitungsbedingungen nicht geeignet

- wear resistant micro-grain grade
- suitable for the machining of low alloyed titanium
- not suitable for interrupted cut and other unfavourable machining conditions

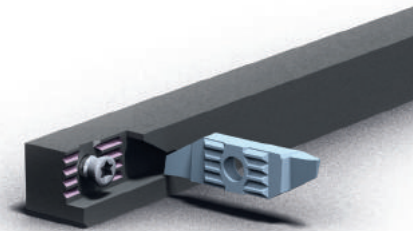

Rigid clamping system

Paramètres de coupe indicatifs

Empfohlene Schnittwerte



Standard machining data

Matière Werkstoff Material		Tournage Drehen Turning		Tronçonnage Abstechen Parting off	
		VC (m/min)	F (mm/U)	VC (m/min)	F (mm/U)
Acier de décolletage Automatenstahl Free-cutting steel	P	120 - 200	0.01 - 0.20	80 - 150	0.01 - 0.15
Acier Stahl Steel	P	< 600 N/mm ² 80 - 160	0.01 - 0.18	70 - 120	0.01 - 0.12
Acier Stahl Steel	P	< 800 N/mm ² 60 - 120	0.01 - 0.15	60 - 100	0.01 - 0.10
Acier Stahl Steel	P	> 800 N/mm ² 50 - 100	0.01 - 0.12	40 - 80	0.01 - 0.08
Acier inoxydable Rostfreistahl Stainless steel	M	60 - 120	0.01 - 0.15	60 - 100	0.01 - 0.08
Aluminium	N	180 - 800	0.01 - 0.30	150 - 300	0.01 - 0.20
Cuivre, laiton, bronze Kupfer, Messing, Bronze Copper, brass, bronze	N	100 - 500	0.01 - 0.30	100 - 300	0.01 - 0.20
Titane Titan Titanium	S	30 - 70	0.01 - 0.12	30 - 50	0.01 - 0.06

Accessoires

Zubehöre

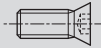
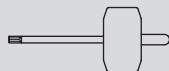
Accessories

Porte-outils Halter Holders			
250-8 / 260-8	V-M3.5X7.3-T15	C-T15	SET-NM-TX15
250-... / 260-...	V-M4X9-T15		
250RC / 260-C	V-M4X7.3-T15		

Recommandation de serrage
Drehmoment Empfehlung
Clamping recommendation

3.0 Nm

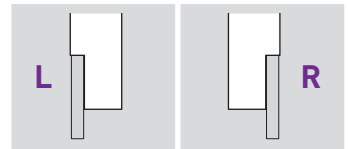
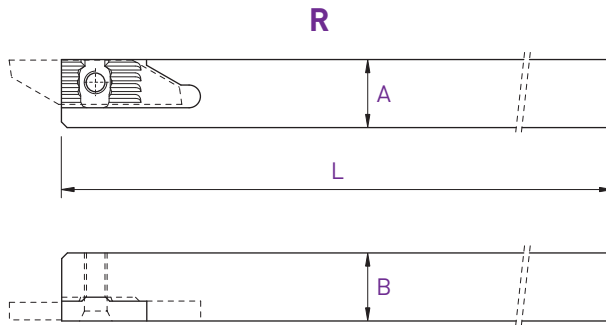

A x B	L	Art. N°	Art. N°
8 x 8	115	250-8	260-8
10 x 10	115	250-10	260-10
12 x 12	130	250-12	260-12
12 x 12	90	250-12-90	260-12-90
12.7 x 12.7	130	250-12.7	260-12.7
16 x 16	130	250-16	260-16
16 x 16	75	250-16-75	260-16-75
20 x 20	120	250-20	260-20

Chaque support est livré avec vis et clé.
 Jeder Halter wird mit Spannschraube(n) und Schlüssel geliefert.
 Screw(s) and key are included with each tool holder.

Porte-outils

Halter

Holder

260-C

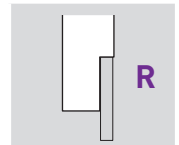
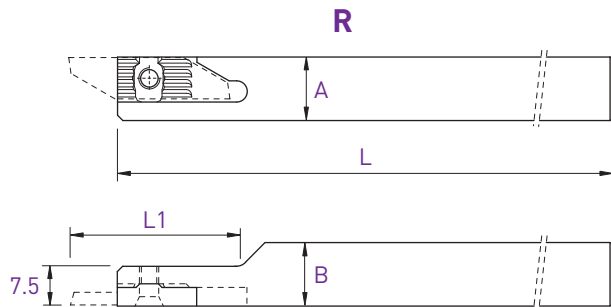
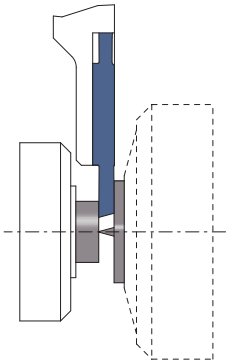

A x B	L	L1	Art. N°
12 x 12	130	30	260-C-12

Porte-outils

Halter

Holder

Coupe à droite déportée
Versetzes Rechtsschneiden
Right cut off line

250RC

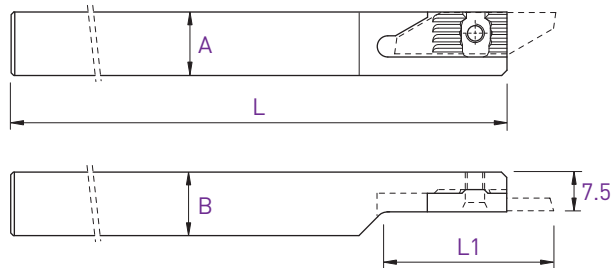
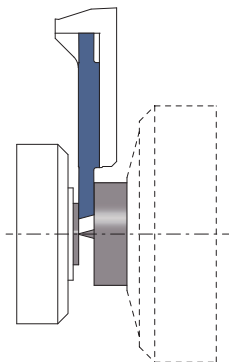

L (R)			Art. N°
A x B	L	L1	
12 x 12	130	30	250RC-12
16 x 16	130	40	250RC-16

Utiliser des plaquettes type 251R
WSP Typ 251R verwenden
Use inserts type 251R



Chaque support est livré avec vis et clé.
Jeder Halter wird mit Spannschraube(n) und Schlüssel geliefert.
Screw(s) and key are included with each tool holder.

Porte-outils avec arrosage intégré
 Halter mit integrierter Kühlmittelzufuhr
 Holders with integrated coolant supply

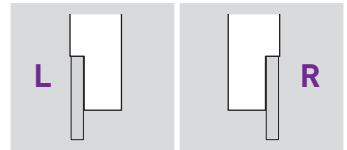
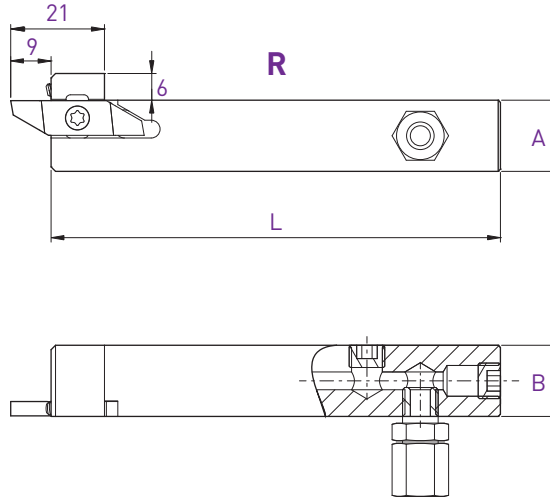
250-JET / 260-JET

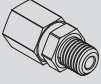

A x B	L	Art. N°	Art. N°
10 x 12	100	250-1012-JET	260-1012-JET
12 x 12	100	250-12-JET	260-12-JET
16 x 16	100	250-16-JET	260-16-JET
20 x 20	100	250-20-JET	260-20-JET

Pièces de rechange Ersatzteile Spare parts			Buse Düse Nozzle 
	Art. N°	Art. N°	Art. N°
250-JET / 260-JET	J-M8X1-D6	JB-M8X1	JJ-M3X6-D1.5

Chaque support est livré avec vis et clé.
 Jeder Halter wird mit Spannschraube(n) und Schlüssel geliefert.
 Screw(s) and key are included with each tool holder.

Porte-outils

Halter

Holder

260/250F

L/R

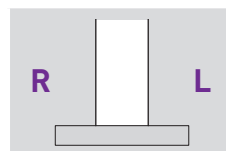
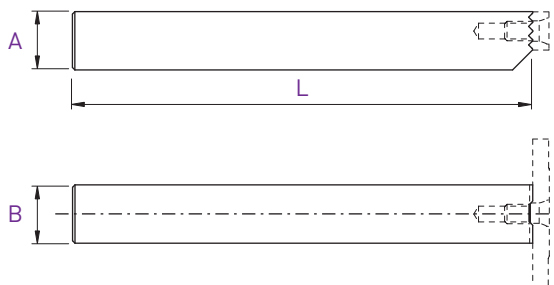

A x B	L	Art. N°
10 x 12	120	260/250F-1012
12 x 12	120	260/250F-1212

Porte-outils

Halter

Holder

260/250-D

L/R

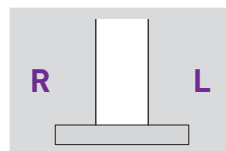
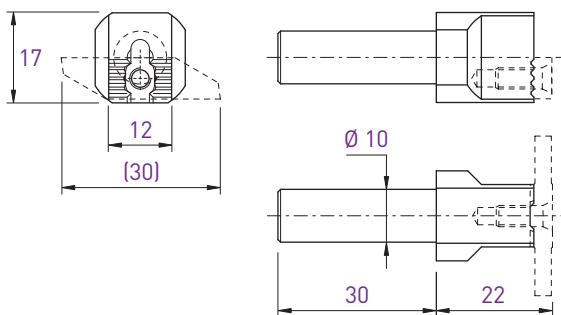

Art. N°
260/250-D10

Chaque support est livré avec vis et clé.
 Jeder Halter wird mit Spannschraube(n) und Schlüssel geliefert.
 Screw(s) and key are included with each tool holder.

ECO-LINE

Tronçonnage
Abstechen
Parting off

251 / 261

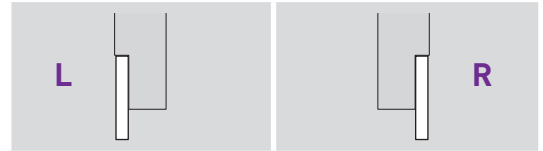
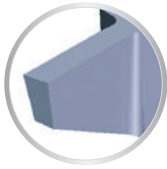
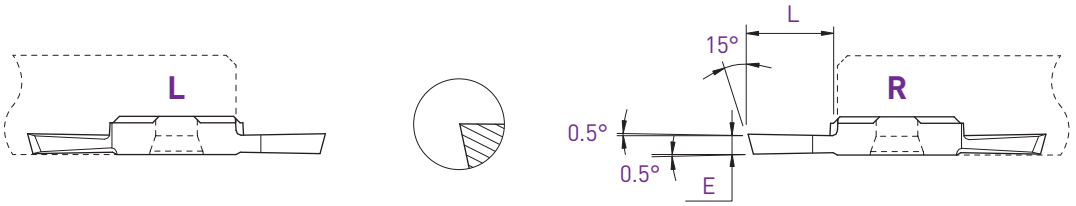

E	L	Art. N°	AP302	AP202	N (µk20)	Art. N°	AP302	AP202	N (µk20)
0.8	4	251-0.8	■	□	■	261-0.8	■	□	■
1.0	5	251-1.0	■	□	■	261-1.0	■	□	■
1.2	5	251-1.2	■	□	■	261-1.2	■	□	■
1.5	7	251-1.5	■	□	■	261-1.5	■	□	■
2.0	8.5	251-2.0	■	□	■	261-2.0	■	□	■
2.5	8.5	251-2.5	■	□	■	261-2.5	■	□	■

Tronçonnage
Abstechen
Parting off

Coupe déportée
Versetztes Schneiden
Cut off line

261L / 251R

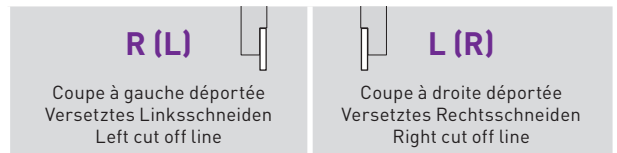
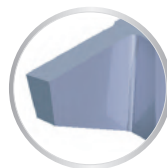
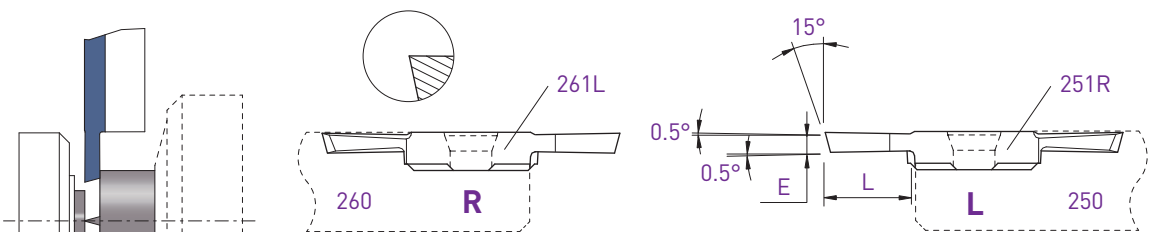

		R (L)			L (R)				
		Coupe à gauche déportée Versetztes Linksschneiden Left cut off line			Coupe à droite déportée Versetztes Rechtsschneiden Right cut off line				
E	L	Art. N°	AP302	AP202	N (µk20)	Art. N°	AP302	AP202	N (µk20)
1.0	5	-				251R-1.0	■	□	■
1.5	7	-				251R-1.5	■	□	■
2.0	8.5	261L-2.0	■	□	■	251R-2.0	■	□	■

Tronçonnage

Abstechen

Parting off

251XF / 261XF

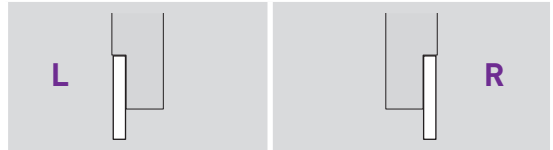
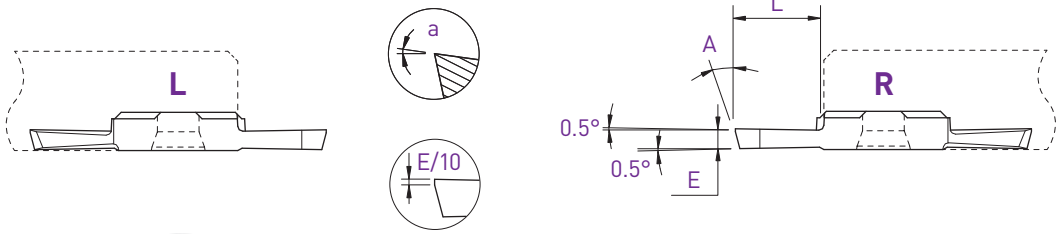

a	E	L	A	Art. N°	AP302	AP202	N (µk20)	Art. N°	AP302	AP202	N (µk20)
4°	1.0	4	15°	-				261XF-1.0	■	■	
6°	1.0	4	8°	-				261XF6°-1.0-8°	■	■	
4°	1.5	7	15°	251XF-1.5	■	□	■	261XF-1.5	■	□	■
4°	2.0	8.5	15°	251XF-2.0	■	□	■	261XF-2.0	■	□	■

Tronçonnage

Abstechen

Parting off

Coupe déportée

Versetztes Schneiden

Cut off line

251RXF

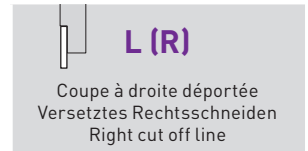
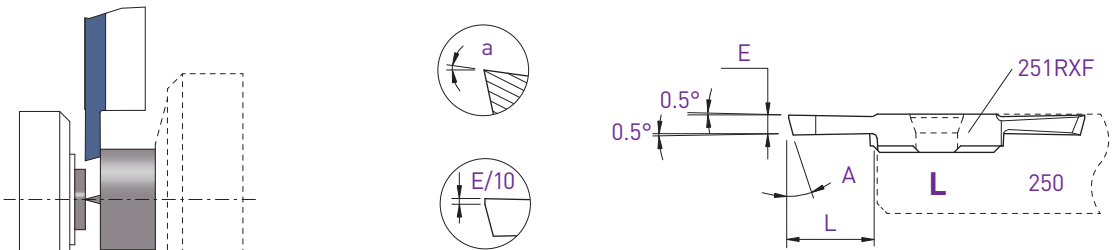

a	E	L	A	Art. N°	AP302	AP202	N (µk20)
6°	1.0	4	8°	251RXF6°-1.0-8°	■	■	
4°	1.5	7	15°	251RXF-1.5	■	□	■
4°	2.0	8.5	15°	251RXF-2.0	■	□	■

■ = disponible / verfügbar / available
□ = selon disponibilité du stock / jenach Lagerverfügbarkeit / depending on stock availability

ECO-LINE

Tournage avant
Vorwärts drehen
Front turning

252 / 262

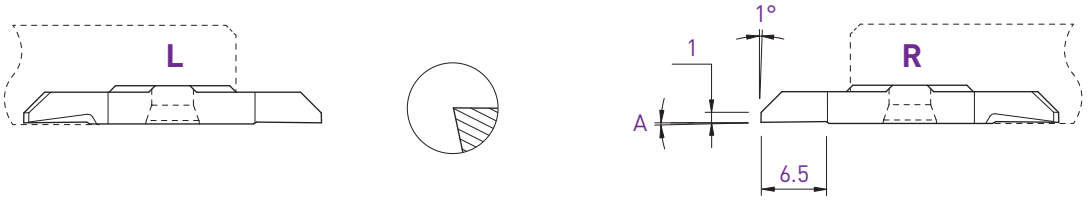

A	Art. N°	AP302	AP202	N (µk20)	Art. N°	AP302	AP202	N (µk20)
0°	252	■	□	■	262	■	□	■
2°	252-2°	■	□	■	262-2°	■	□	■

Tournage avant
Vorwärts drehen
Front turning

252X / 262X

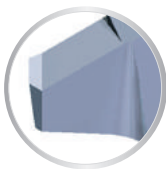
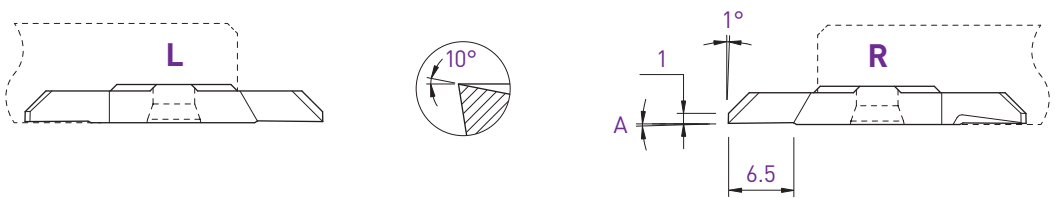

A	Art. N°	AP302	AP202	N (µk20)	Art. N°	AP302	AP202	N (µk20)
0°	252X	■	□	■	262X	■	□	■
2°	252X-2°	■	□	■	262X-2°	■	□	■

Tournage avant
Vorwärts drehen
Front turning

252S / 262S

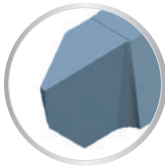
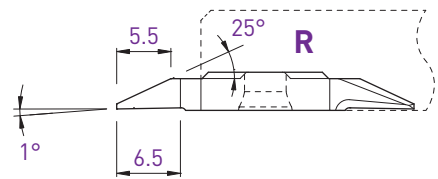
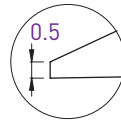
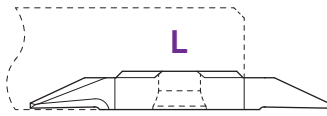

L				R			
Art. N°	AP302	AP202	N (µk20)	Art. N°	AP302	AP202	N (µk20)
252S05	■	□	■	262S05	■	□	■

Tournage arrière
Rückwärts drehen
Back turning

253S / 263S

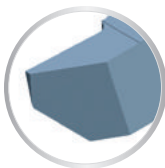
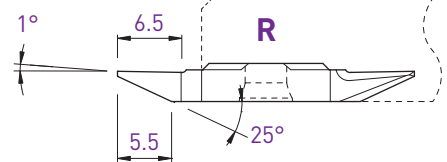
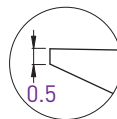
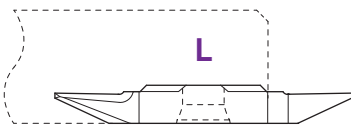

L				R			
Art. N°	AP302	AP202	N (µk20)	Art. N°	AP302	AP202	N (µk20)
253S05	■	□	■	263S05	■	□	■

ECO-LINE

Tournage arrière
Rückwärts drehen
Back turning

253 / 263

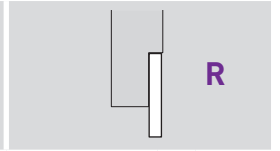
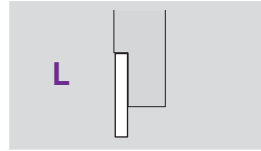
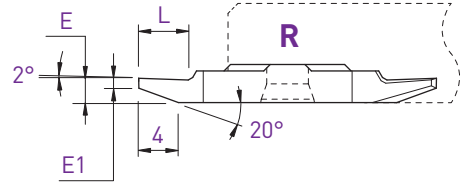
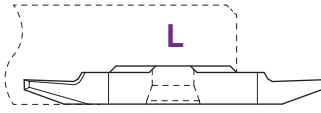

E	E1	L	Art. N°	AP302	AP202	N (µk20)	Art. N°	AP302	AP202	N (µk20)
2.0	0.5	4	253-0.5	■	□	■	263-0.5	■	□	■
2.5	1.0	5	253-1.0	■	□	■	263-1.0	■	□	■

Tournage arrière
Rückwärts drehen
Back turning

253X / 263X

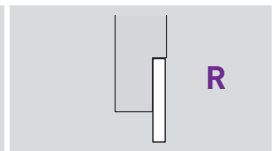
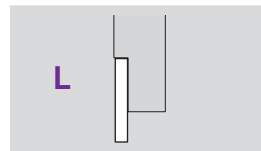
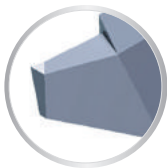
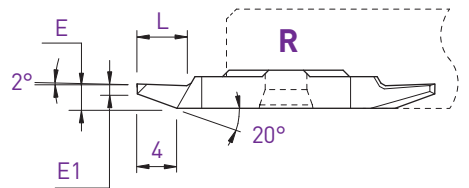
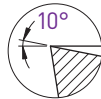
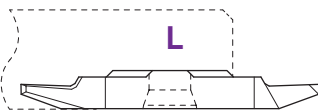

E	E1	L	Art. N°	AP302	AP202	N (µk20)	Art. N°	AP302	AP202	N (µk20)
2.0	0.5	5	253X-0.5	■	□	■	263X-0.5	■	□	■
2.5	1.0	5	253X-1.0	■	□	■	263X-1.0	■	□	■

Tournage arrière
Rückwärts drehen
Back turning

253VX-8° / 263VX-8°

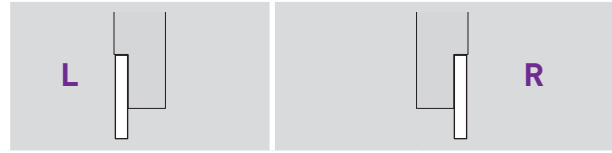
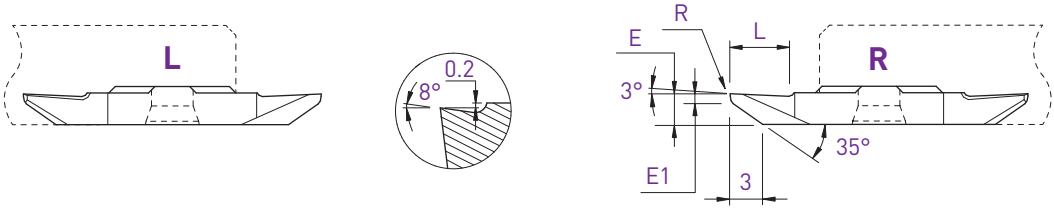

E	E1	L	R	Art. N°	AP302	AP202	N (µk20)	Art. N°	AP302	AP202	N (µk20)	AH302	HN (µk10)
3.1	1.0	6	0	253VX-8°	■	□	■	263VX-8°	■	□	■		
3.1	1.0	6	0.08	-				263VX-8°-R08	■	□	■	■	■
3.1	1.0	6	0.20	-				263VX-8°-R20	■	□	■	■	■

Tournage arrière
Rückwärts drehen
Back turning

253VX-805 / 263VX-805

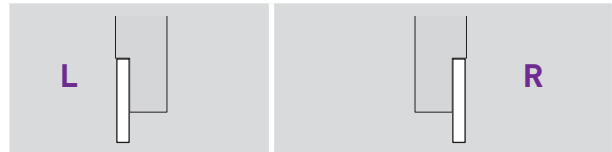
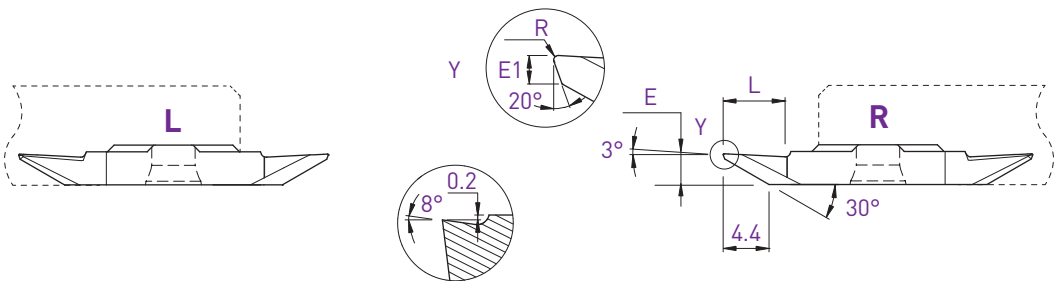

E	E1	L	R	Art. N°	AP302	AP202	N (µk20)	Art. N°	AP302	AP202	N (µk20)	AH302	HN (µk10)
3.0	0.5	6	0.08	253VX-805-R08	■	□	■	263VX-805-R08	■	□	■	■	■

■ = disponible / verfügbar / available
□ = selon disponibilité du stock / jenach Lagerverfügbarkeit / depending on stock availability

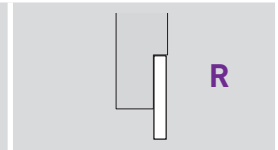
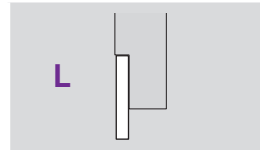
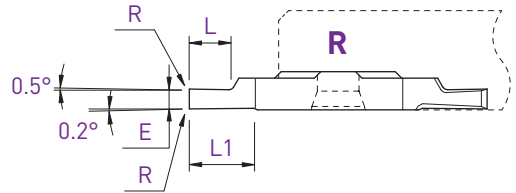
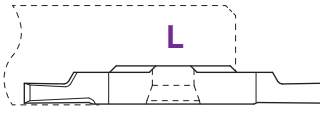

E	L	L1	R	Art. N°	AP302	AP202	N [µk20]	Art. N°	AP302	AP202	N [µk20]
0.8	2	4	0	254-0.8	■	□	■	264-0.8	■	□	■
1.0	2.5	4	0	254-1.0	■	□	■	264-1.0	■	□	■
1.2	3	4	0	254-1.2	■	□	■	264-1.2	■	□	■
1.5	3	4	0	254-1.5	■	□	■	264-1.5	■	□	■
1.8	4	6.5	0	-				264-1.8	■	□	■
2.0	4	6.5	0	254-2.0	■	□	■	264-2.0	■	□	■
2.5	6	6.5	0	254-2.5	■	□	■	264-2.5	■	□	■
3.0	6.5	6.5	0	254-3.0	■	□	■	264-3.0	■	□	■

Fonçage-tournage

Einstecken und drehen

Grooving and turning

254X / 264X

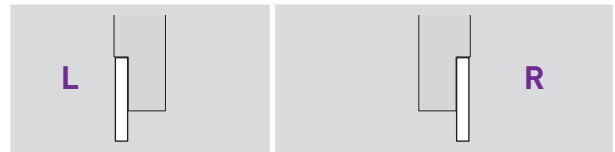
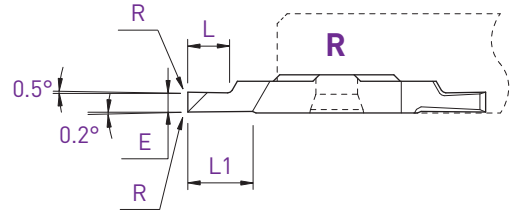
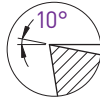
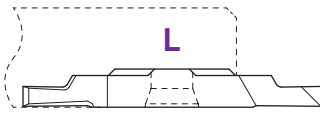

E	L	L1	R	Art. N°	AP302	AP202	N [µk20]	Art. N°	AP302	AP202	N [µk20]	AH302	HN [µk10]
0.8	2	4	0	254X-0.8	■	□	■	264X-0.8	■	□	■		
1.0	2.5	4	0	254X-1.0	■	□	■	264X-1.0	■	□	■		
1.0	2.5	4	0.08	-				264X-1.0-R08	■	□	■	■	■
1.2	3	4	0	254X-1.2	■	□	■	264X-1.2	■	□	■		
1.5	3	4	0	254X-1.5	■	□	■	264X-1.5	■	□	■		
1.5	3	4	0.08	-				264X-1.5-R08	■	□	■	■	■
1.5	3	4	0.20	-				264X-1.5-R20	■	□	■	■	■
2.0	4	6.5	0	254X-2.0	■	□	■	264X-2.0	■	□	■		
2.0	4	6.5	0.08	-				264X-2.0-R08	■	□	■	■	■
2.0	4	6.5	0.20	-				264X-2.0-R20	■	□	■	■	■
2.5	6	6.5	0	254X-2.5	■	□	■	264X-2.5	■	□	■		
2.5	6.5	6.5	0.08	-				264X-2.5-R08	■	□	■	■	■
2.5	6.5	6.5	0.20	-				264X-2.5-R20	■	□	■	■	■
3.0	6.5	6.5	0	254X-3.0	■	□	■	264X-3.0	■	□	■		
3.0	6.5	6.5	0.08	-				264X-3.0-R08	■	□	■	■	■
3.0	6.5	6.5	0.20	-				264X-3.0-R20	■	□	■	■	■

Filetage
Gewinde drehen
Threading

Partial profile 60°

256-60 / 266-60

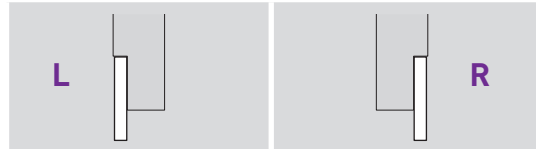
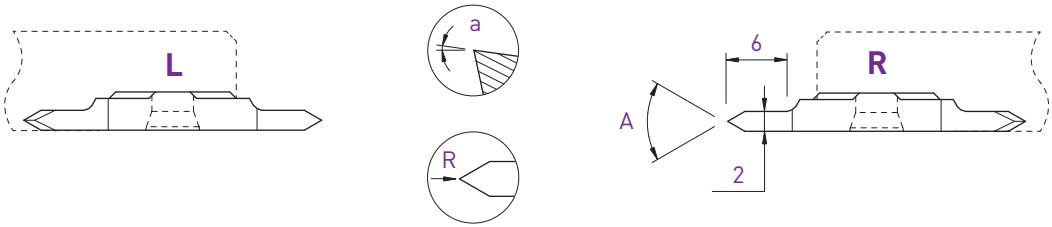

A	R	a	Art. N°	AP302	AP202	N (µk20)	Art. N°	AP302	AP202	N (µk20)
60°	0	0°	256-60-2.0	■	□	■	266-60-2.0	■	□	■
60°	0.06	3°	256-AG60°	■	□	■	266-AG60°	■	□	■

Filetage
Gewinde drehen
Threading

Partial profile 55°

256-55 / 266-55

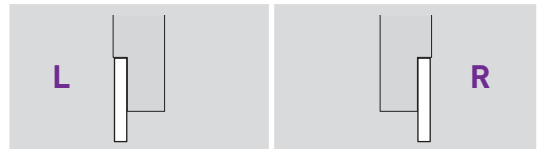
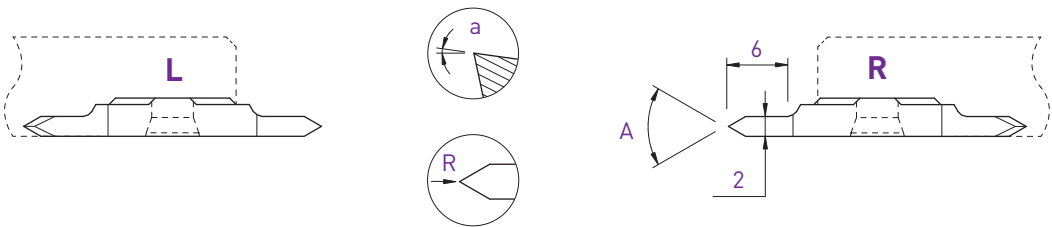

A	R	a	Art. N°	AP302	AP202	N (µk20)	Art. N°	AP302	AP202	N (µk20)
55°	0	0°	256-55-2.0	■	□	■	266-55-2.0	■	□	■
55°	0.06	3°	256-AG55°	■	□	■	266-AG55°	■	□	■

Plaquettes ébauches

WSP-Rohlinge

Blank inserts

251-E / 261-E

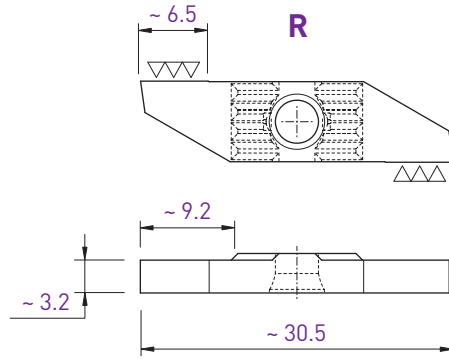
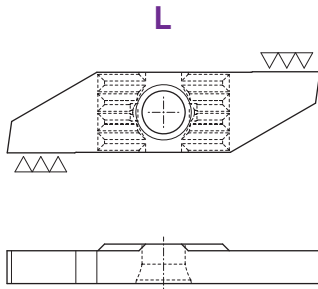

L					R						
Art. N°	AP302	AP202	N [µk20]	AH302	HN [µk10]	Art. N°	AP302	AP202	N [µk20]	AH302	HN [µk10]
251-E	■	□	■	■	■	261-E	■	□	■	■	■

new

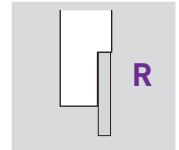
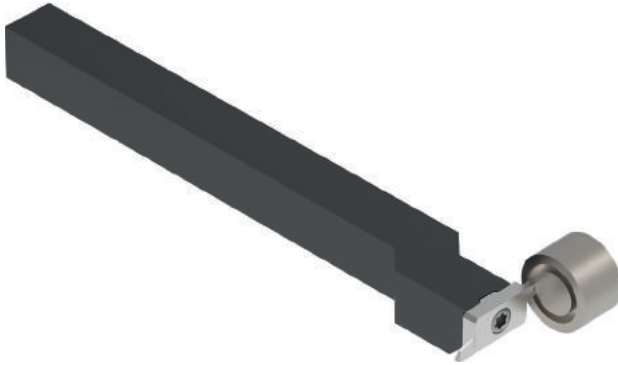
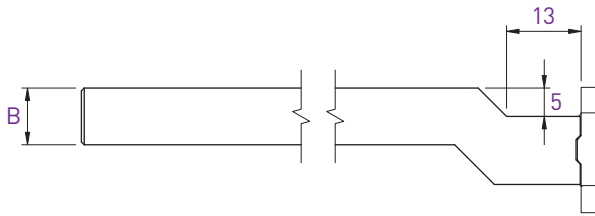
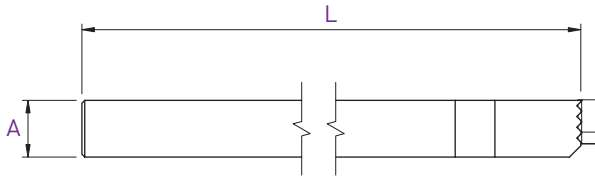

A x B	L	Art. N°
8x10	130	250RFG-0810
10x10	130	250RFG-1010
12x12	130	250RFG-1212
16x16	130	250RFG-1616

Pièces de rechange
Ersatzteile
Spare parts

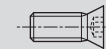

Art. N°

V-M4X9-T15



Art. N°

C-T15

Plaquettes ébauches

WSP-Rohlinge

Blank inserts

251RFG

new

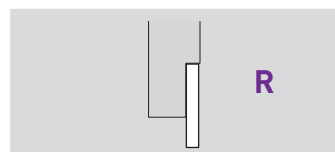
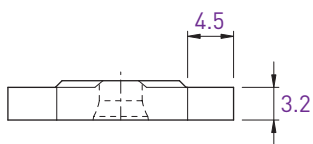
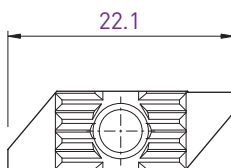

Art. N°	N (µm20)	AP302
251RFG-EP	■	■

APPLITEC

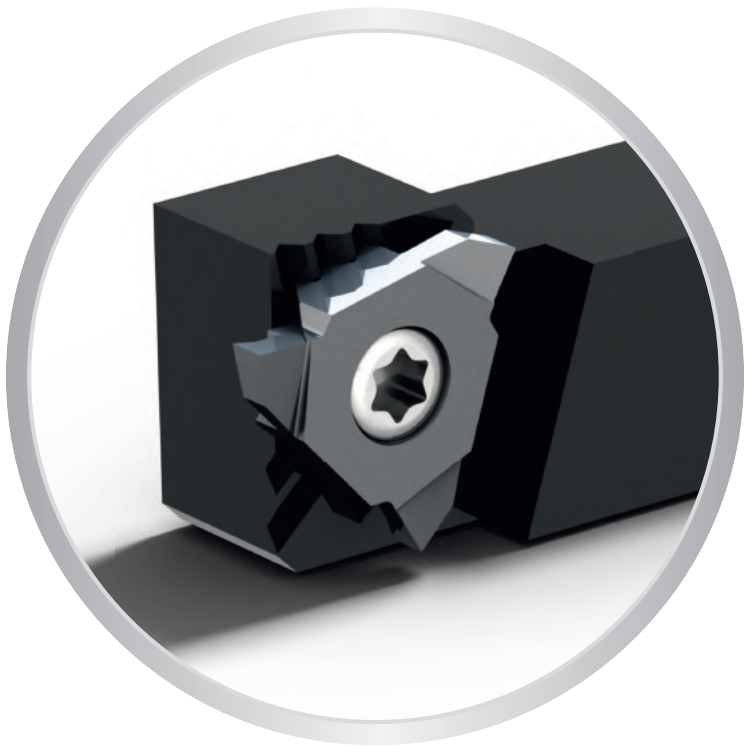

Nuances
Sorten
Grades

> 5.02

Conseils d'utilisation - Accessoires
Anwendungsempfehlungen - Zubehör
Application recommendations - Accessories



> 5.03

Porte-outils
Halter
Holders

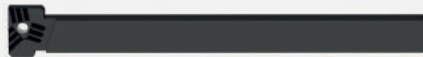

> 5.04

GX

Gorge de précision
Präzisionseinstechen
High precision grooving

DIN6799
& DIN471



> 5.05

FT

Tournage finition
Schlicht drehen
Fine turning



> 5.06

GT

Fonçage-tournage
Einstechen und drehen
Grooving and turning



> 5.07

GTX

Fonçage-tournage avec coupe positive
Einstechen und drehen mit positivem Spanwinkel
Grooving and turning with positive cut



> 5.08

EP

Plaquettes ébauches
WSP-Rohlinge
Blank inserts



> 5.09

Rigid clamping system with the famous Applitec teeth clamping

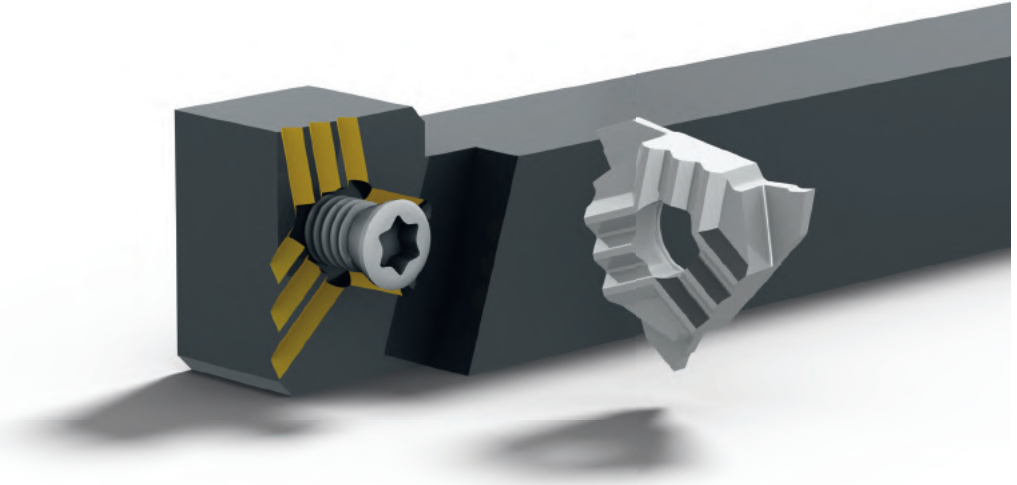

Nuances micro-grain à dureté élevée

Verschleissfeste Feinkornsorten

Wear resistant micro-grain grades

HTA

μK10 + revêtement PVD
μK10 + PVD Beschichtung
μK10 + PVD coating

- nuance très résistante à l'usure
- pour l'usinage en finition dans des conditions favorables des aciers, aciers inoxydables et alliages de titane

- sehr verschleissfeste Sorte
- für die Feinbearbeitung von Stahl, rostfreiem Stahl und Titanlegierungen bei guten Bearbeitungsbedingungen

- very wear resistant grade
- for light machining of steel, stainless steel and titanium alloys under favourable machining conditions

HN (μK10)

non revêtu
unbeschichtet
uncoated

- nuance micro-grain très résistante à l'usure
- recommandé pour l'usinage du laiton, de l'aluminium et du titane faiblement allié

- sehr verschleissfeste Feinkornsorte
- für die Bearbeitung von Messing und niedrig legiertem Aluminium und Titan empfehlenswert

- very wear resistant micro-grain grade
- suitable for the machining of brass and low alloyed aluminium and titanium

Paramètres de coupe indicatifs

Empfohlene Schnittwerte

Standard machining data

Matière Werkstoff Material	Tournage Drehen Turning		Foncer Einstechen Grooving	
	VC (m/min)	F (mm/U)	VC (m/min)	F (mm/U)
Acier de décolletage Automatenstahl Free-cutting steel	P 120 - 200	0.01 - 0.20	80 - 150	0.01 - 0.15
Acier Stahl Steel < 600 N/mm ²	P 80 - 160	0.01 - 0.18	70 - 120	0.01 - 0.12
Acier Stahl Steel < 800 N/mm ²	P 60 - 120	0.01 - 0.15	60 - 100	0.01 - 0.10
Acier Stahl Steel > 800 N/mm ²	P 50 - 100	0.01 - 0.12	40 - 80	0.01 - 0.08
Acier inoxydable Rostfreistahl Stainless steel	M 60 - 120	0.01 - 0.15	60 - 100	0.01 - 0.08
Aluminium	N 180 - 800	0.01 - 0.30	150 - 300	0.01 - 0.20
Cuivre, laiton, bronze Kupfer, Messing, Bronze Copper, brass, bronze	N 100 - 500	0.01 - 0.30	100 - 300	0.01 - 0.20
Titane Titan Titanium	S 30 - 70	0.01 - 0.12	30 - 50	0.01 - 0.06

Accessoires

Zubehöre

Accessories

Porte-outils Halter Holders			
T216-H...	V-M4X9-T15	C-T15	SET-NM-TX15

Recommandation de serrage
Drehmoment Empfehlung
Clamping recommendation

3.0 Nm

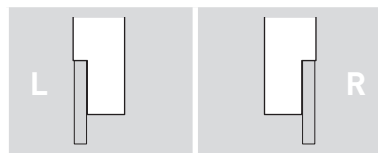
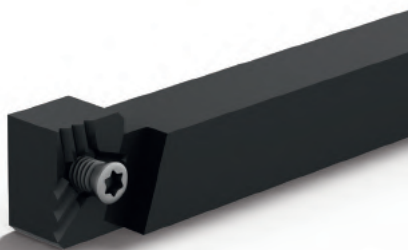
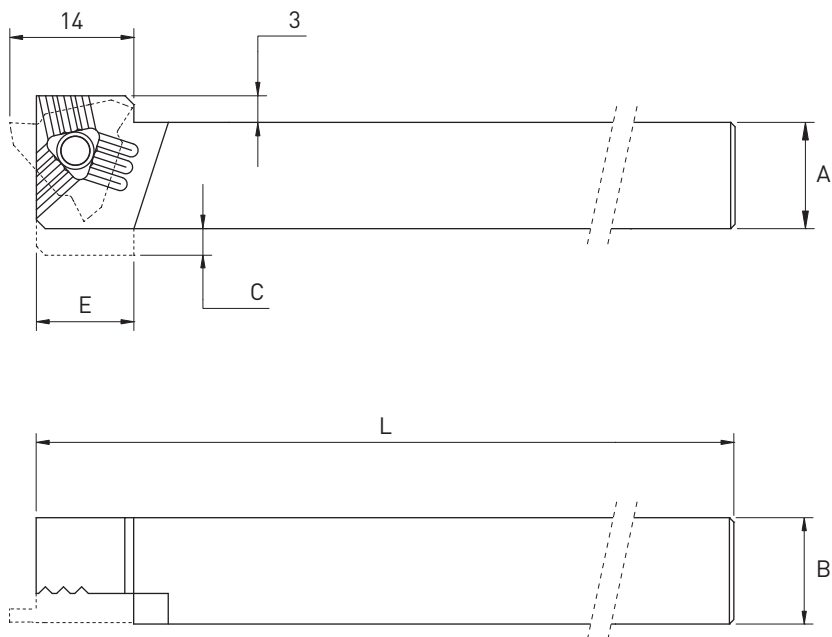

Chaque support est livré avec vis et clé.
 Jeder Halter wird mit Spannschraube(n)
 und Schlüssel geliefert.
 Screw(s) and key are included with each
 tool holder.

AxB	C	E	L	Art. N°	Art. N°
8x10	4	11	115	T216-H0810L	T216-H0810R
10x10	2	8	130	T216-H1010L	T216-H1010R
12x12	-	-	130	T216-H1212L	T216-H1212R
12x12	-	-	90	T216-H1212L-90	T216-H1212R-90
16x16	-	-	120	T216-H1616L	T216-H1616R
20x20	-	-	130	T216-H2020L	T216-H2020R

Plaquettes de gorge pour circlips

Einstechwendeplatte für Seegerring

Grooving inserts for retaining ring

GX

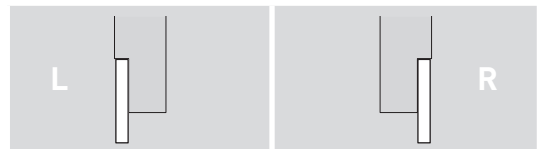
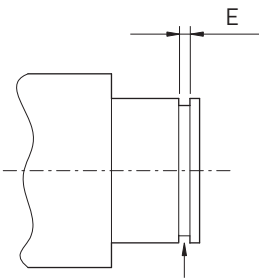
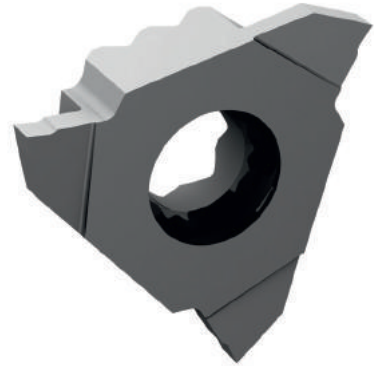
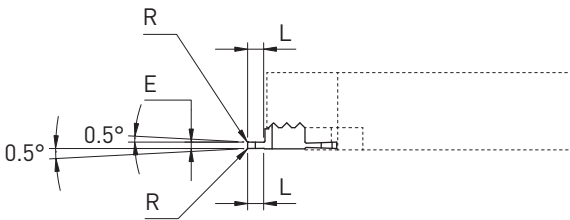
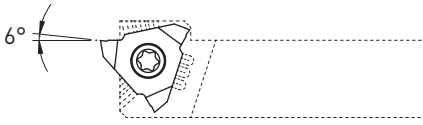

Selon DIN6799 et DIN471
Gemäss DIN6799 und DIN471
According to DIN6799 and DIN471

E ±0.01	L	R	L		R	
			Art. N°	HTA HN	Art. N°	HTA HN
0.26	0.8	0.03	T216L-GX026	■ ■	T216R-GX026	■ ■
0.36	0.8	0.03	T216L-GX036	■ ■	T216R-GX036	■ ■
0.46	0.8	0.03	T216L-GX046	■ ■	T216R-GX046	■ ■
0.50	1.5	0.03	T216L-GX050	■ ■	T216R-GX050	■ ■
0.57	1.5	0.03	T216L-GX057	■ ■	T216R-GX057	■ ■
0.67	1.5	0.03	T216L-GX067	■ ■	T216R-GX067	■ ■
0.77	2.0	0.03	T216L-GX077	■ ■	T216R-GX077	■ ■
0.87	2.0	0.03	T216L-GX087	■ ■	T216R-GX087	■ ■
0.97	2.5	0.03	T216L-GX097	■ ■	T216R-GX097	■ ■
1.00	2.5	0.03	T216L-GX100	■ ■	T216R-GX100	■ ■
1.10	2.5	0.03	T216L-GX110	■ ■	T216R-GX110	■ ■
1.20	2.5	0.03	T216L-GX120	■ ■	T216R-GX120	■ ■
1.30	2.5	0.03	T216L-GX130	■ ■	T216R-GX130	■ ■
1.50	2.5	0.03	T216L-GX150	■ ■	T216R-GX150	■ ■
1.60	2.5	0.03	T216L-GX160	■ ■	T216R-GX160	■ ■
1.85	2.5	0.03	T216L-GX185	■ ■	T216R-GX185	■ ■
2.00	2.5	0.03	T216L-GX200	■ ■	T216R-GX200	■ ■
2.50	2.5	0.03	T216L-GX250	■ ■	T216R-GX250	■ ■



TRIO-LINE

Tournage avant
Vorwärts drehen
Front turning

FT

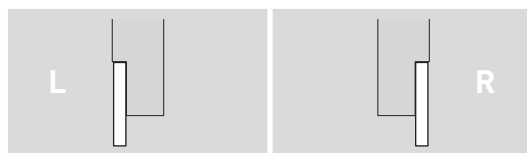
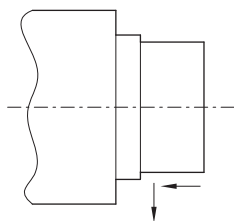
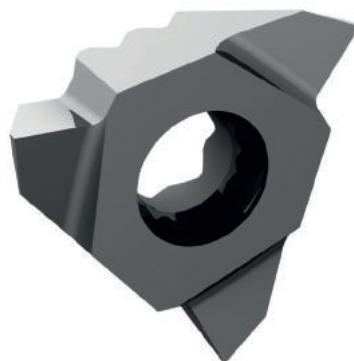
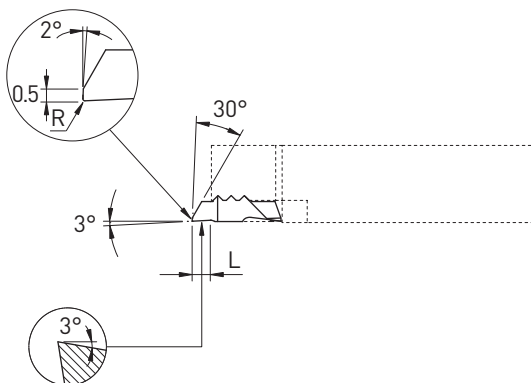
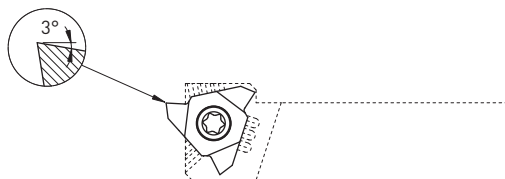

		L		R	
L	R	Art. N°	HTA HN	Art. N°	HTA HN
3.0	0.03	T216L-FT	■ ■	T216R-FT	■ ■
3.0	0.08	T216L-FT-R08	■ ■	T216R-FT-R08	■ ■

Fonçage-tournage

Einstecken und drehen

Grooving and turning

GT

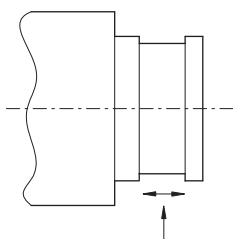
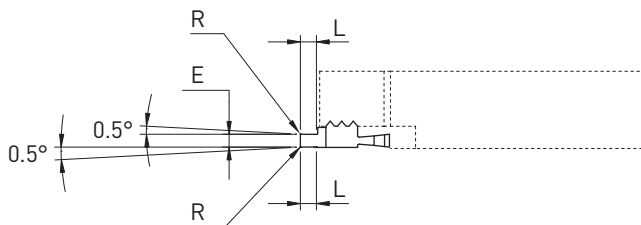
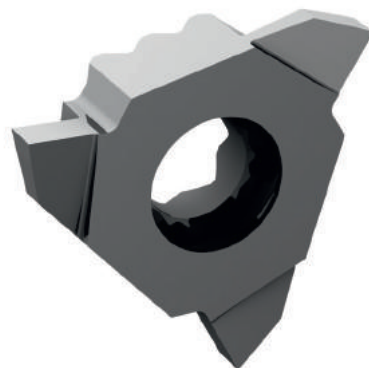
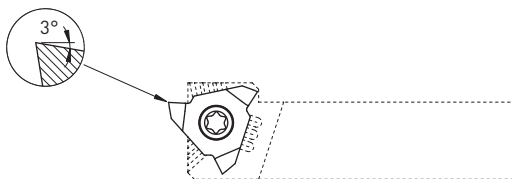

E	L	R	Art. N°	HTA		Art. N°	HN	
				■	■		■	■
0.5	1.5	0.03	T216L-GT050	■	■	T216R-GT050	■	■
1.0	2.5	0.03	T216L-GT100	■	■	T216R-GT100	■	■
1.0	2.5	0.08	T216L-GT100-R08	■	■	T216R-GT100-R08	■	■
1.5	2.5	0.03	T216L-GT150	■	■	T216R-GT150	■	■
1.5	2.5	0.08	T216L-GT150-R08	■	■	T216R-GT150-R08	■	■
1.5	2.5	0.15	T216L-GT150-R15	■	■	T216R-GT150-R15	■	■
2.0	2.5	0.03	T216L-GT200	■	■	T216R-GT200	■	■
2.0	2.5	0.08	T216L-GT200-R08	■	■	T216R-GT200-R08	■	■
2.0	2.5	0.15	T216L-GT200-R15	■	■	T216R-GT200-R15	■	■
2.5	2.5	0.15	T216L-GT250-R15	■	■	T216R-GT250-R15	■	■

TRIO-LINE

Fonçage-tournage
Einstecken und drehen
Grooving and turning

GTX

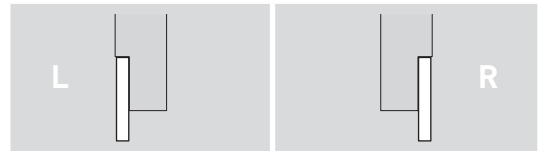
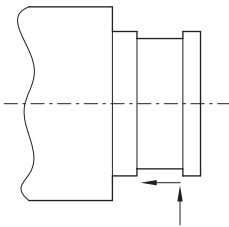
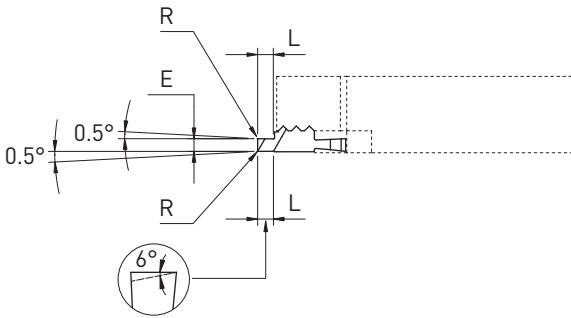
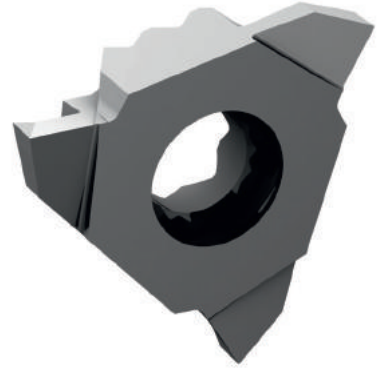
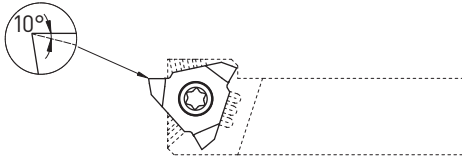

E	L	R	L		R	
			Art. N°	HTA HN	Art. N°	HTA HN
1.0	2.5	0.03	T216L-GTX100	■ ■	T216R-GTX100	■ ■
1.0	2.5	0.08	T216L-GTX100-R08	■ ■	T216R-GTX100-R08	■ ■
1.5	2.5	0.03	T216L-GTX150	■ ■	T216R-GTX150	■ ■
1.5	2.5	0.08	T216L-GTX150-R08	■ ■	T216R-GTX150-R08	■ ■
1.5	2.5	0.15	T216L-GTX150-R15	■ ■	T216R-GTX150-R15	■ ■
2.0	2.5	0.03	T216L-GTX200	■ ■	T216R-GTX200	■ ■
2.0	2.5	0.08	T216L-GTX200-R08	■ ■	T216R-GTX200-R08	■ ■
2.0	2.5	0.15	T216L-GTX200-R15	■ ■	T216R-GTX200-R15	■ ■
2.5	2.5	0.15	T216L-GTX250-R15	■ ■	T216R-GTX250-R15	■ ■

- Plaquettes ébauches
- WSP-Rohlinge
- Blank inserts

EP

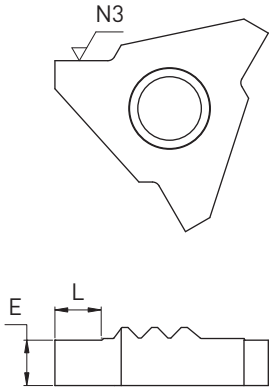

		L		R	
E	L	Art. N°	HTA HN	Art. N°	HTA HN
~3	3	T216L-EP	■	T216R-EP	■



300 Series

3 contact points

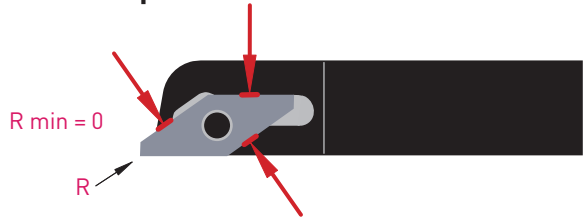

rigid clamping system

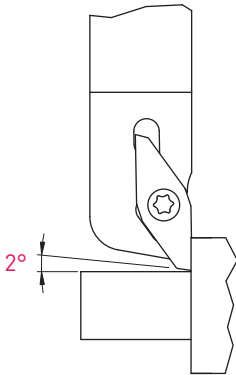

“wiper effect”

Pour un meilleur état de surface
Für eine bessere Oberflächengüte
For a better surface finish



Conseils d'utilisation et paramètres de coupe indicatifs
 Anwendungsempfehlungen und empfohlene Schnittwerte
 Application recommendations and standard machining data

> 6.02

Tournage avant
 Vorwärts drehen
 Front turning

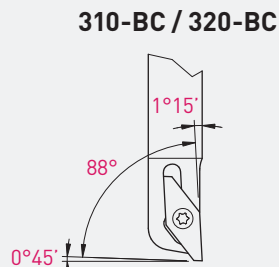
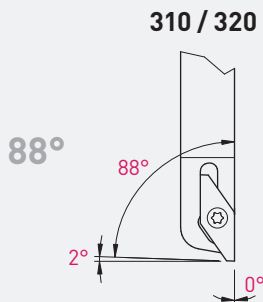

Tournage avant
 Vorwärts drehen
 Front turning

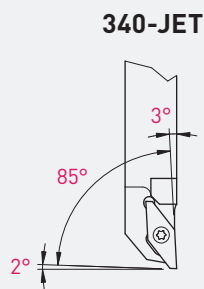
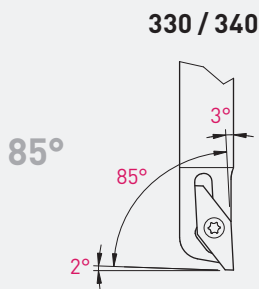







TURN-LINE

Conseils d'utilisation

Anwendungsempfehlungen

Application recommendations

Géométries de coupe Spanformgeometrien Cutting geometry		P		M		N		S		★					
		Acier de décolletage Automatenstahl Free-cutting steel		Acier Stahl Steel		Acier inoxydable Rostfreistahl Stainless steel		Aluminium		Laiton, bronze Messing, Bronze Brass, bronze		Cuivre Kupfer Copper		Titane Titane Titanium	
		★		★		★		★		★		★		Recommandé Empfohlen Recommended	
		★		★		★		★		★		★		Pour pièces fragiles de très petits diamètres Für empfindliche und sehr kleine Werkstücke For fragile and very small work pieces	
	3_7	★	★	★	★	★			★	★	Géométrie universelle, très bonne maîtrise du copeau Allgemeine Geometrie, sehr gute Spankontrolle All-round insert with efficient chip control				
	3_7-EN	☆	★	☆							Arête renforcée (augmente l'effort de coupe) Verstärkte Schneidkante (Schneidkraftehöhung) Reinforced cutting edge (increases cutting force) f min: 0.02 mm/U				
	3_8	☑	☑	☑			★				Géométrie plate classique Standard flache Geometrie Standard flat geometry				
	3_8VS	☆		☆	☑				☑	☑	Brise-copeau pour usinage léger en finition Spanbrecher für leichte Schlichtbearbeitung Chip-breaker for light finishing operation				
	3_8VX	★	★	★	★				★	★	Très bonne maîtrise du copeau Sehr gute Spankontrolle Very efficient chip control				
	3_8X	★	★	★	☆				☆	★	Coupe positive traditionnelle Standard positive Geometrie Standard positive geometry				
	3_9	☆	☆	☆			☆				Témoin plat sur la coupe pour réduire les vibrations Vibrationsreduzierung durch einer Flachfase und der Schneidkante Vibration reduction through flat ended cutting edge				

Nuances micro-grain à dureté élevée

Verschleissfeste Feinkornsorten

Wear resistant micro-grain grades

<p>P M N S</p> <h2>TiAlN</h2> <p>μK20 + revêtement PVD μK20 + PVD Beschichtung μK20 + PVD coating</p>	<p>P M N <input type="checkbox"/>S</p> <h2>TiN</h2> <p>μK20 + revêtement PVD μK20 + PVD Beschichtung μK20 + PVD coating</p>	<p>P M <input type="checkbox"/>N S</p> <h2>TiAlX</h2> <p>μK20 + revêtement PVD μK20 + PVD Beschichtung μK20 + PVD coating</p>	<p>P <input type="checkbox"/>M N S</p> <h2>N (μK20)</h2> <p>non revêtu unbeschichtet uncoated</p>
<ul style="list-style-type: none"> excellente nuance universelle 1^{er} choix pour l'usinage des aciers, aciers inoxydables et alliages de titane très bonne résistance à la température 	<ul style="list-style-type: none"> nuance pour l'usinage des matières peu résistantes qui créent des arêtes rapportées très faible coefficient de frottement à éviter pour l'usinage du titane 	<ul style="list-style-type: none"> nuance très résistante à l'usure et à la température, recommandée pour l'usinage des matières suivantes: Inox 304, 316L, 317L, 904, Phynox aciers alliés contenant: Chrome Nickel, Vanadium, Molybdène, ... 	<ul style="list-style-type: none"> supporte les coupes interrompues et autres conditions d'usinage défavorables
<ul style="list-style-type: none"> beste Universalsorte für die Bearbeitung von Stahl, rostfreiem Stahl und Titanlegierungen bestens geeignet sehr gute Warmfestigkeit 	<ul style="list-style-type: none"> Sorte für die Bearbeitung von weichen Werkstoffen mit Tendenz zur Bildung von Aufbauschneiden sehr geringer Reibwert für die Bearbeitung von Titan nicht geeignet 	<ul style="list-style-type: none"> sehr verschleissfeste und temperaturbeständige Sorte. Für folgende Materialien empfohlen: Inox 304, 316L, 317L, 904, Phynox legierter Stahl enthaltend: Chrom-Nickel, Vanadium, Molybdän, ... 	<ul style="list-style-type: none"> für unterbrochene Schnitte und andere ungünstige Bearbeitungsbedingungen geeignet
<ul style="list-style-type: none"> best universal grade first choice for steel, stainless steel and titanium alloys machining very good heat resistance 	<ul style="list-style-type: none"> grade for the machining of low resistance materials which causes edge build-up very low friction ratio not suitable for titanium machining 	<ul style="list-style-type: none"> very wear and high temperature resistant grade. Recommended for following material: Inox 304, 316L, 317L, 904, Phynox alloy steel containing: Chrome-nickel, Vanadium, Molybdenum, ... 	<ul style="list-style-type: none"> suitable for interrupted cut and other unfavourable machining conditions
<p>P M N S</p> <h2>HTA</h2> <p>μK10 + revêtement PVD μK10 + PVD Beschichtung μK10 + PVD coating</p>	<p>P M N <input type="checkbox"/>S</p> <h2>HTiN</h2> <p>μK10 + revêtement PVD μK10 + PVD Beschichtung μK10 + PVD coating</p>	<p>P M <input type="checkbox"/>N S</p> <h2>HTAX</h2> <p>μK10 + revêtement PVD μK10 + PVD Beschichtung μK10 + PVD coating</p>	<p>P <input type="checkbox"/>M N S</p> <h2>HN (μK10)</h2> <p>non revêtu unbeschichtet uncoated</p>
<ul style="list-style-type: none"> nuance très résistante à l'usure pour l'usinage en finition dans des conditions favorables des aciers, aciers inoxydables et alliages de titane 	<ul style="list-style-type: none"> nuance pour l'usinage en finition des matières peu résistantes qui créent des arêtes rapportées très faible coefficient de frottement à éviter pour l'usinage du titane 	<ul style="list-style-type: none"> nuance très résistante à l'usure et à la température, pour l'usinage en finition avec faible avance de petites pièces. Recommandée pour l'usinage des matières suivantes: Inox 304, 316L, 317L, 904, Phynox aciers alliés contenant: Chrome Nickel, Vanadium, Molybdène, ... 	<ul style="list-style-type: none"> nuance micro-grain très résistante à l'usure recommandé pour l'usinage du titane faiblement allié déconseillé en cas de coupe interrompue et autres conditions d'usinage défavorables
<ul style="list-style-type: none"> sehr verschleissfeste Sorte für die Feinbearbeitung von Stahl, rostfreiem Stahl und Titanlegierungen bei guten Bearbeitungsbedingungen 	<ul style="list-style-type: none"> Sorte für die Feinbearbeitung von weichen Werkstoffen mit Tendenz zur Bildung von Aufbauschneiden sehr geringer Reibwert für die Bearbeitung von Titan nicht geeignet 	<ul style="list-style-type: none"> sehr verschleissfeste und temperaturbeständige Sorte, für Feinbearbeitung von kleinen Teilen mit geringer Vorschub. Für folgende Materialien empfohlen: Inox 304, 316L, 317L, 904, Phynox legierter Stahl enthaltend: Chrom-Nickel, Vanadium, Molybdän, ... 	<ul style="list-style-type: none"> verschleissfeste Feinkornsorte für die Bearbeitung von niedrig legiertem Titan empfehlenswert für unterbrochene Schnitte und andere ungünstige Bearbeitungsbedingungen nicht geeignet
<ul style="list-style-type: none"> very wear resistant grade for light machining of steel, stainless steel and titanium alloys under favourable machining conditions 	<ul style="list-style-type: none"> grade for light machining of low resistance materials which causes edge build-up very low friction ratio not suitable for titanium machining 	<ul style="list-style-type: none"> very wear and high temperature resistant grade, for light machining of small parts with low cutting feed. Recommended for following material: Inox 304, 316L, 317L, 904, Phynox alloy steel containing: Chrome-nickel, Vanadium, Molybdenum, ... 	<ul style="list-style-type: none"> wear resistant micro-grain grade suitable for the machining of low alloyed titanium not suitable for interrupted cut and other unfavourable machining conditions

TURN-LINE

Paramètres de coupe indicatifs

Empfohlene Schnittwerte

Standard machining data

Matière Werkstoff Material		Tournage Drehen Turning		
		VC	Prof. de passe Schnitttiefe Depth of cut	Avance Vorschub Feed
		(m/min)	(mm)	(mm/U)
Acier de décolletage Automatenstahl Free-cutting steel	P	120 - 200	0.05 - 1.0 1.0 - 4.0	0.01 - 0.15 0.05 - 0.25
Acier Stahl Steel	< 600 N/mm ² P	80 - 160	0.05 - 1.0 1.0 - 4.0	0.01 - 0.15 0.05 - 0.25
Acier Stahl Steel	< 800 N/mm ² P	60 - 120	0.05 - 1.0 1.0 - 4.0	0.01 - 0.10 0.05 - 0.20
Acier Stahl Steel	> 800 N/mm ² P	50 - 100	0.05 - 1.0 1.0 - 3.0	0.01 - 0.08 0.05 - 0.15
Acier inoxydable Rostfreistahl Stainless steel	M	60 - 120	0.05 - 1.0 1.0 - 3.0	0.01 - 0.08 0.05 - 0.15
Aluminium Si <12%	N	200 - 1000	0.05 - 1.0 1.0 - 4.0	0.01 - 0.20 0.05 - 0.40
Aluminium Si >12%	N	180 - 800	0.05 - 1.0 1.0 - 4.0	0.01 - 0.20 0.05 - 0.40
Cuivre, laiton, bronze Kupfer, Messing, Bronze Copper, brass, bronze	N	100 - 500	0.05 - 1.0 1.0 - 4.0	0.01 - 0.20 0.05 - 0.35
Titane Titan Titanium	S	30 - 70	0.05 - 1.0 1.0 - 4.0	0.01 - 0.08 0.05 - 0.15

Indications pour premier réglage

Hinweise für die erste Einrichtung

Indications for first setting

Ébauche Schruppen Roughing	Finition Schlichten Finishing
<ul style="list-style-type: none"> • vitesse de coupe moyenne • avance élevée 	<ul style="list-style-type: none"> • vitesse de coupe élevée • avance faible
<ul style="list-style-type: none"> • durchschnittliche Schnittgeschwindigkeit • hohe Schnittgeschwindigkeit 	<ul style="list-style-type: none"> • hohe Schnittgeschwindigkeit • niedriger Vorschub
<ul style="list-style-type: none"> • average cutting feed • high cutting feed 	<ul style="list-style-type: none"> • high cutting feed • low cutting feed

Remarques importantes
Wichtige Bemerkungen
Important remarks

- en raison des limites de la machine, il n'est souvent pas possible d'atteindre les vitesses de coupe préconisées
- les outils Applitec sont spécialement développés pour permettre de hautes performances, même dans des conditions de coupe défavorables
- des applications non préconisées dans le tableau ci-contre peuvent également s'avérer efficaces

- wegen begrenzter Maschinenleistung ist es oft nicht möglich, die vorgeschlagenen Schnittgeschwindigkeiten zu erreichen
- Applitec Werkzeuge sind besonders dazu entwickelt, um sogar bei ungünstigen Schnittdaten leistungsfähig zu sein
- die in der nebenstehender Tabelle nicht erwähnten Anwendungsfälle können sich auch effizient erweisen

- in many cases, it is impossible to reach the recommended cutting speed, due to the machine limits
- Applitec tools are especially designed to be efficient even in bad cutting conditions
- applications not mentioned in the opposite table can also be efficient

TURN-LINE

Porte-outils

Halter

Holder

88°

310 / 320

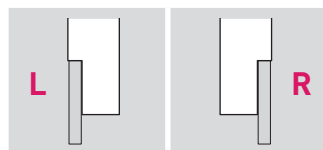
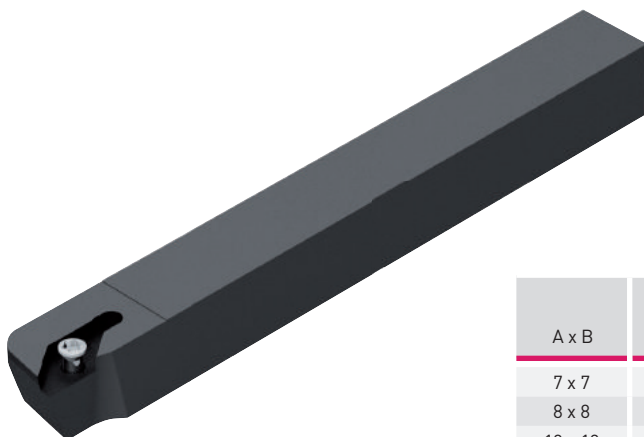
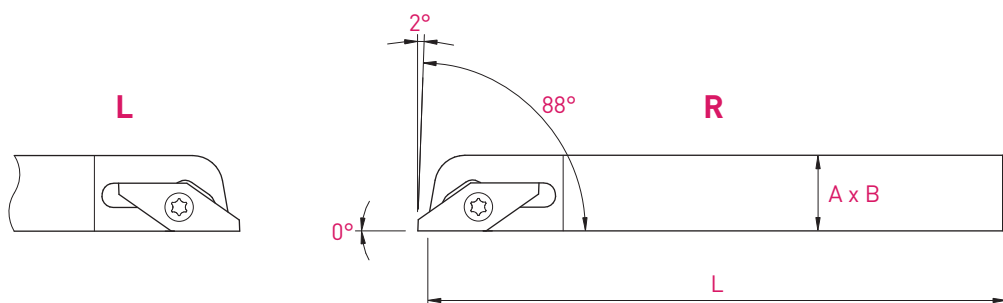

A x B	L	Art. N°	Art. N°
7 x 7	115	310-7	320-7
8 x 8	115	310-8	320-8
10 x 10	115	310-10	320-10
10 x 10	140	-	320-10-140
12 x 12	115	310-12	320-12
12 x 12	90	310-12-90	320-12-90
12 x 12	140	310-12-140	320-12-140
12.7 x 12.7	140	310-12.7	320-12.7
16 x 16	100	310-16	320-16
16 x 16	140	310-16-140	320-16-140
20 x 20	120	310-20	320-20

Porte-outils

Halter

Holder

88°

310-BC / 320-BC

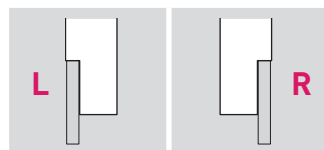
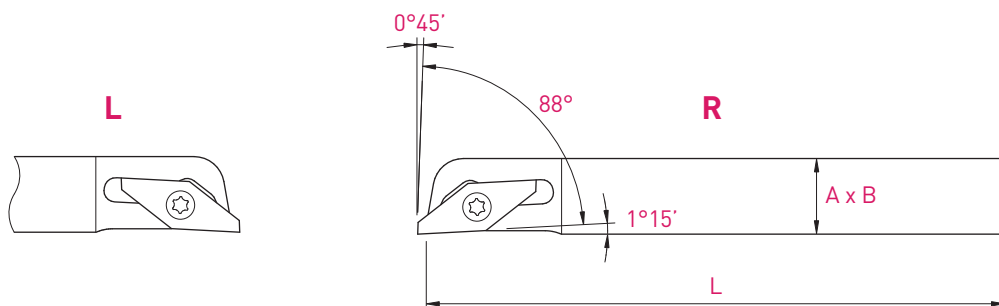

A x B	L	Art. N°	Art. N°
7 x 7	115	310-7-BC	320-7-BC
8 x 8	115	310-8-BC	320-8-BC
10 x 10	115	310-10-BC	320-10-BC
10 x 10	140	-	320-10-140-BC
12 x 12	115	310-12-BC	320-12-BC
12 x 12	90	310-12-90-BC	320-12-90-BC
12 x 12	140	310-12-140-BC	320-12-140-BC
12.7 x 12.7	140	310-12.7-BC	320-12.7-BC
16 x 16	100	310-16-BC	320-16-BC
16 x 16	140	310-16-140-BC	320-16-140-BC
20 x 20	120	310-20-BC	320-20-BC

Porte-outils Halter Holder	Serrage standard (A) Standard Spannsystem (A) Standard clamping system (A)
311 / 321	V-M2.5X6.5-T8
312 - 316	C-T8
322 - 326	

Chaque support est livré avec vis et clé.
Jeder Halter wird mit Spannschraube(n) und Schlüssel geliefert.
Screw(s) and key are included with each tool holder.

TURN-LINE

Tournage avant
Vorwärts drehen
Front turning

88°

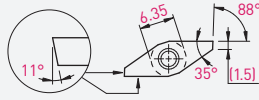

310 / 320

317 / 327

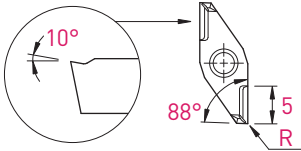

R	Art. N°	L						R						
		TiAlN	TiN	N (µk20)	HTA	HTiN	HN (µk10)	TiAlN	TiN	N (µk20)	HTA	HTiN	HN (µk10)	
0	317	■	■	■	■	■	■	327	■	■	■	■	■	■
0.03	317-R03	■	■	■	■	■	■	327-R03	■	■	■	■	■	■
0.08	317-R08	■	■	■	■	■	■	327-R08	■	■	■	■	■	■
0.10	317-R10	■	■	■	■	■	■	327-R10	■	■	■	■	■	■
0.20	317-R20	■	■	■	■	■	■	327-R20	■	■	■	■	■	■

318 / 328

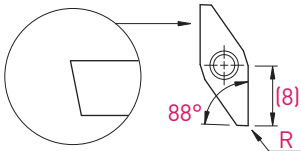

R	Art. N°	L			R			
		HTA	HTiN	HN (µk10)	HTA	HTiN	HN (µk10)	
0	318	■	■	■	328	■	■	■
0.05	318-R05	■	■	■	328-R05	■	■	■
0.10	318-R10	■	■	■	328-R10	■	■	■
0.20	318-R20	■	■	■	328-R20	■	■	■
0.40	318-R40	■	■	■	328-R40	■	■	■

318VS / 328VS

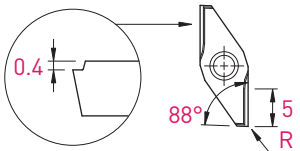

R	Art. N°	L			R			
		HTA	HTiN	HN (µk10)	HTA	HTiN	HN (µk10)	
0	318VS	■	■	■	328VS	■	■	■
0.10	318VS-R10	■	■	■	328VS-R10	■	■	■

Tournage avant
Vorwärts drehen
Front turning

88°

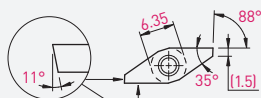

310 / 320

318VX / 328VX

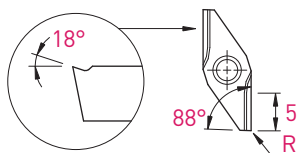

R	Art. N°	L			R		
		HTA	HTiN	HN (µk10)	HTA	HTiN	HN (µk10)
0	318VX	■	■	■	■	■	■
0.05	318VX-R05	■	■	■	■	■	■
0.10	318VX-R10	■	■	■	■	■	■
0.20	-				■	■	■
0.40	-				■	□	■

318X / 328X

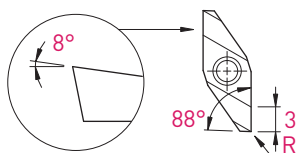

R	Art. N°	L			R		
		HTA	HTiN	HN (µk10)	HTA	HTiN	HN (µk10)
0	318X	■	■	■	■	■	■
0.10	318X-R10	■	■	■	■	■	■

319 / 329

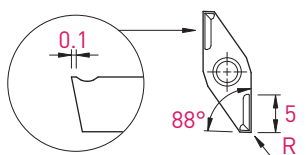

R	Art. N°	L			R		
		HTA	HTiN	HN (µk10)	HTA	HTiN	HN (µk10)
0	319	■	■	■	■	■	■
0.10	319-R10	■	■	■	■	■	■
0.20	319-R20	■	■	■	■	■	■

■ = disponible / verfügbar / available
□ = selon disponibilité du stock / jenach Lagerverfügbarkeit / depending on stock availability

TURN-LINE

Porte-outils

Halter

Holder

85°

330 / 340

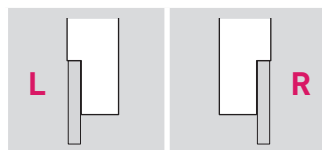
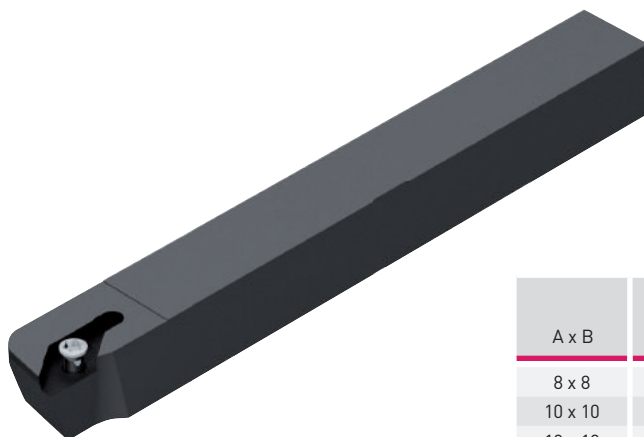
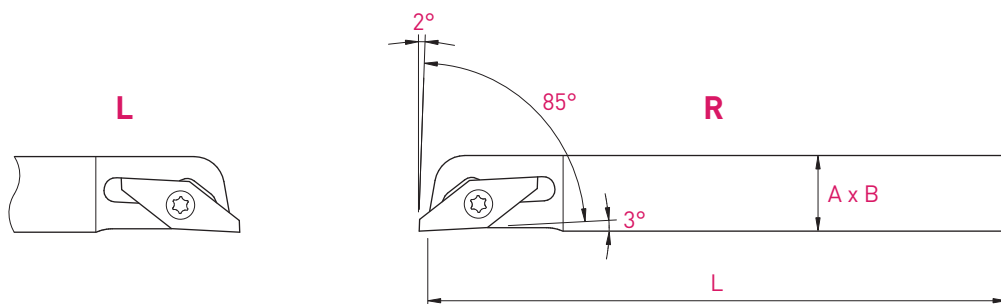

A x B	L	Art. N°	Art. N°
8 x 8	115	330-8	340-8
10 x 10	115	330-10	340-10
10 x 10	140	-	340-10-140
12 x 12	115	330-12	340-12
12 x 12	90	330-12-90	340-12-90
12 x 12	140	330-12-140	340-12-140
12.7 x 12.7	140	330-12.7	340-12.7
16 x 16	100	330-16	340-16
16 x 16	140	330-16-140	340-16-140
20 x 20	120	330-20	340-20

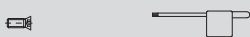
Porte-outils Halter Holder	Serrage standard (A) Standard Spannsystem (A) Standard clamping system (A) 
332 - 336 342 - 346	V-M2.5X7.8-T8 C-T8

Chaque support est livré avec vis et clé.
Jeder Halter wird mit Spannschraube(n) und Schlüssel geliefert.
Screw(s) and key are included with each tool holder.

Porte-outils avec arrosage intégré
 Halter mit integrierter Kühlmittelzufuhr
 Holders with integrated coolant supply

85°

340-JET

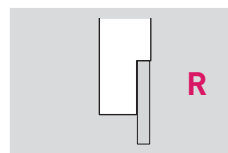
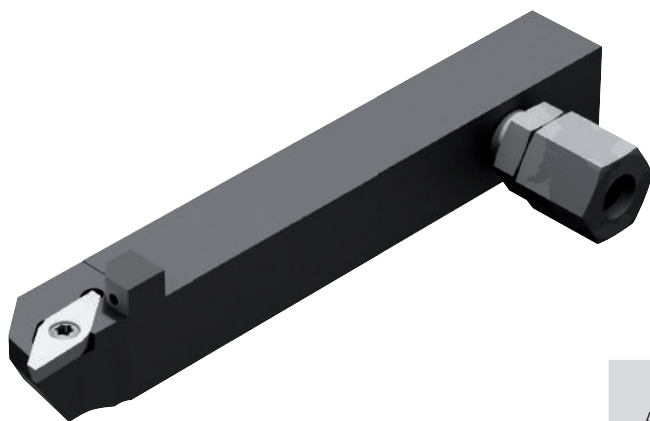
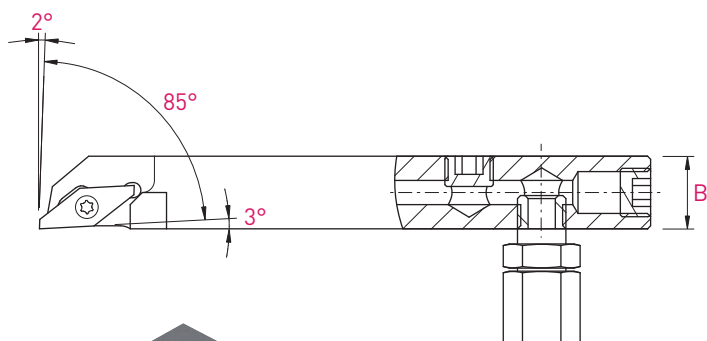
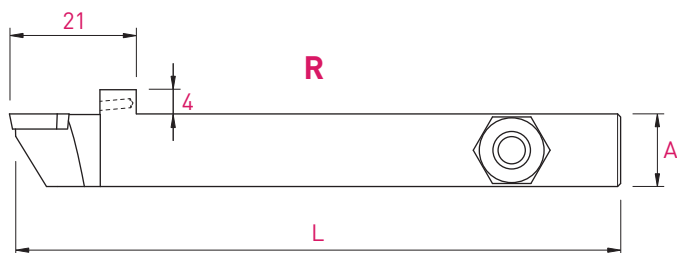

Pièces de rechange Ersatzteile Spare parts	Option		
	Art. N°	Art. N°	Art. N°
340-0810-JET	J-M5-D5	JC-M5-D5	JB-M5
340-JET	J-M8X1-D6	-	JB-M8X1

A x B	L	Art. N°
8 x 10	100	340-0810-JET
10 x 12	100	340-1012-JET
12 x 12	100	340-12-JET
12.7 x 12.7	100	340-12.7-JET
16 x 16	100	340-16-JET
20 x 20	100	340-20-JET

Chaque support est livré avec vis et clé.
 Jeder Halter wird mit Spannschraube(n) und Schlüssel geliefert.
 Screw(s) and key are included with each tool holder.

TURN-LINE

Tournage avant
Vorwärts drehen
Front turning

85°

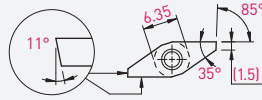

330 / 340

337 / 347

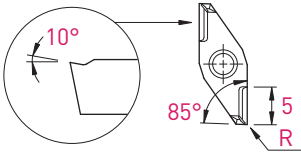

R	Art. N°	L							R							
		TiAlN	TiAlX	TiN	N [μk20]	HTA	HTiN	HN [μk10]	TiAlN	TiAlX	TiN	N [μk20]	HTA	HTiN	HN [μk10]	
0	337	■	■	■	■	■	■	■	347	■	■	■	■	■	■	■
0.03	337-R03	■	■	■	■	■	■	■	347-R03	■	■	■	■	■	■	■
0.08	337-R08	■	■	■	■	■	■	■	347-R08	■	■	■	■	■	■	■
0.10	337-R10	■	■	■	■	■	■	■	347-R10	■	■	■	■	■	■	■
0.20	337-R20	■	■	■	■	■	■	■	347-R20	■	■	■	■	■	■	■
0.35	-	■	■	■	■	■	■	■	347-R35	■	■	■	■	■	■	■
0	337-EN	■	■	■	■	■	■	■	347-EN	■	■	■	■	■	■	■
0.03	337-EN-R03	■	□	■	■	■	■	■	347-EN-R03	■	□	■	■	■	■	■
0.08	337-EN-R08	■	□	■	■	■	■	■	347-EN-R08	■	□	■	■	■	■	■
0.10	337-EN-R10	■	□	■	■	■	■	■	347-EN-R10	■	□	■	■	■	■	■
0.20	337-EN-R20	■	□	■	■	■	■	■	347-EN-R20	■	□	■	■	■	■	■
0.35	-	■	□	■	■	■	■	■	347-EN-R35	■	□	■	■	■	■	■

338 / 348

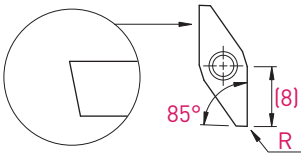

R	Art. N°	L			R			
		HTA	HTiN	HN [μk10]	HTA	HTiN	HN [μk10]	
0	338	■	■	■	348	■	■	■
0.05	338-R05	■	■	■	348-R05	■	■	■
0.10	338-R10	■	■	■	348-R10	■	■	■
0.20	338-R20	■	■	■	348-R20	■	■	■
0.40	338-R40	■	■	■	348-R40	■	■	■

338VS / 348VS

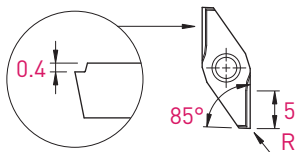

R	Art. N°	L			R			
		HTA	HTiN	HN [μk10]	HTA	HTiN	HN [μk10]	
0	338VS	■	■	■	348VS	■	■	■
0.10	338VS-R10	■	■	■	348VS-R10	■	■	■

Tournage avant
Vorwärts drehen
Front turning

85°

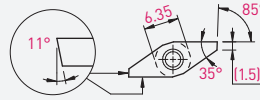

330 / 340

338VX / 348VX

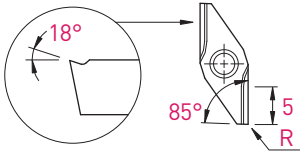

R	Art. N°	L			R		
		HTA	HTiN	HN (µk10)	HTA	HTiN	HN (µk10)
0	338VX	■	■	■	■	■	■
0.05	338VX-R05	■	■	■	■	■	■
0.10	338VX-R10	■	■	■	■	■	■

338X / 348X

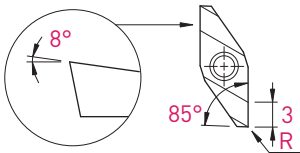

R	Art. N°	L			R		
		HTA	HTiN	HN (µk10)	HTA	HTiN	HN (µk10)
0	338X	■	■	■	■	■	■
0.10	338X-R10	■	■	■	■	■	■

339 / 349

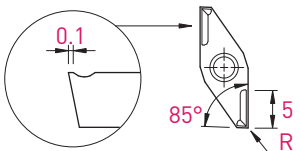

R	Art. N°	L			R		
		HTA	HTiN	HN (µk10)	HTA	HTiN	HN (µk10)
0	339	■	■	■	■	■	■
0.10	339-R10	■	■	■	■	■	■
0.20	339-R20	■	■	■	■	■	■

■ = disponible / verfügbar / available
□ = selon disponibilité du stock / jenach Lagerverfügbarkeit / depending on stock availability

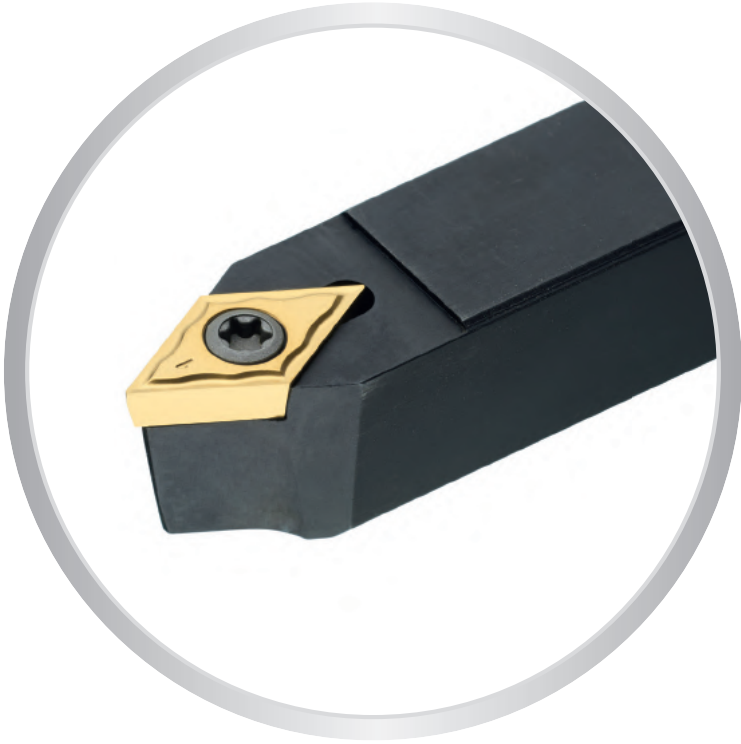

Index

Codification des outils ISO-Line
ISO-Line Bezeichnungssystem
ISO-Line designation system

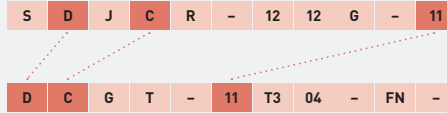

> 7.02

Géométries de coupe
Spanformgeometrien
Cutting geometries



> 7.05

Nuances
Sorten
Grades



> 7.11

Porte-outils
et plaquettes 80°
Halter und
WSP 80°
Holders and
inserts 80°

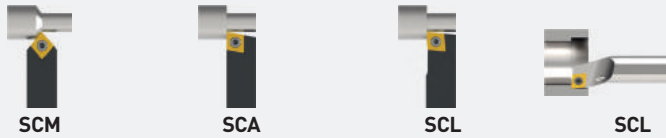

> 7.13

Porte-outils
et plaquettes 55°
Halter und
WSP 55°
Holders and
inserts 55°

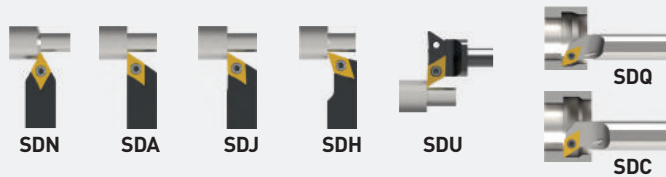

> 7.27

Porte-outils
et plaquettes 35°
Halter und
WSP 35°
Holders and
inserts 35°



> 7.45

Pièces de rechange et accessoires
Ersatzteile und Zubehör
Spare parts and accessories



> 7.61

Paramètres de coupe
Schnittwerte
Machining data

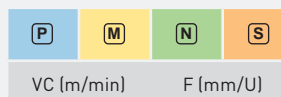

> 7.62

ISO-LINE

Codification des porte-outils ISO-Line

ISO-Line Bezeichnungssystem für Halter

ISO-Line designation system for holders

Méthode de serrage Klemmsystem Clamping system	Forme de la plaquette Plattenform Insert shape	Géométrie du porte-outil Halterform Holder geometry	Angle de dépointe de la plaquette WSP-Freiwinkel Insert clearance angle	Direction de coupe Schneidrichtung Cut direction		Hauteur du porte-outil Halter Höhe Holder height	Largeur du porte-outil Halter-Breite Holder width	Longueur du porte-outil Halter-Länge Holder length		Dimension de la plaquette (L) WSP-Größe (L) Insert size (L)
--	--	---	---	--	--	--	---	--	--	---

S D J C R - 12 12 G - 11

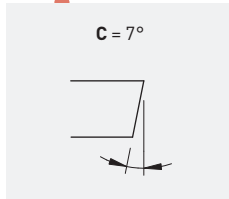
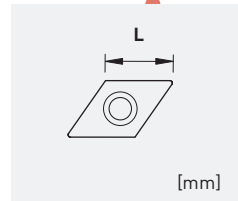
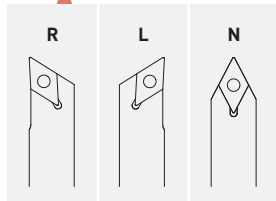

A x B (or Ø) [mm]

- 08 x 08
- 10 x 10
- 12 x 12
- 12.7 x 12.7 (1/2 in)
- 16 x 16
- 20 x 20
- Ø: D10 / D20 / D25.4 (Ø1 in)

Length: [mm]

- F = 75
- G = 90
- J = 110
- X = Special

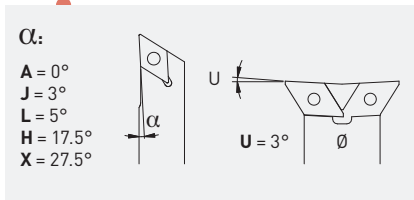

α:

- A = 0°
- J = 3°
- L = 5°
- H = 17.5°
- X = 27.5°

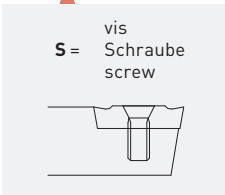
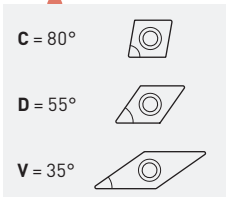

S = vis
Schraube
screw

Compatibilité porte-outil - plaquette
WSP - Halter Kompatibilität
Holder - insert compatibility

S	D	J	C	R	-	12	12	G	-	11
D	C	G	T	-	11	T3	04	-	FN	-

Codification des porte-outils ISO-Line
ISO-Line Bezeichnungssystem für Halter
ISO-Line designation system for holders

Méthode de serrage Klemmsystem Clamping system	Largeur du porte-outil Halter-Breite Holder width	Longueur du porte-outil Halter-Länge Holder length		Méthode de serrage Klemmsystem Clamping system	Forme de la plaquette Plattenform Insert shape	Géométrie du porte-outil Halterform Holder geometry	Angle de dépointe de la plaquette WSP-Freiwinkel Insert clearance angle	Direction de coupe Schneidrichtung Cut direction		Dimension de la plaquette (L) WSP Grösse (L) Insert size (L)
A	12	K	-	S	C	L	C	R	-	06

**Longueur
Länge
Length**
 F = 80
 H = 100
 J = 110
 K = 125
 M = 150
 Q = 180

**Ø queue
Schaft Ø
Shank Ø**

C = 7°

L = 95°
Q = 107.5°
U = 93°

A = acier avec lubrification
Stahl mit Kühlung
Steel with coolant

E = carbure avec lubrification
Hartmetall mit Kühlung
Carbide with coolant

C = 80°

D = 55°

V = 35°

vis
S = Schraube
screw

L

ISO-LINE

Codification des plaquettes ISO-Line

ISO-Line Bezeichnungssystem für WSP

ISO-Line designation system for inserts

Forme de la plaquette Plattenform Insert shape	Angle de dépointe de la plaquette WSP-Freiwinkel Insert clearance angle	Classe de tolérance Toleranz Klasse Tolerance class	Brise-copeau Spanbrecher Chip breaker		Dimension de la plaquette (L) WSP Größe (L) Insert size (L)	Épaisseur de la plaquette (E) WSP Dicke (E) Insert thickness (E)	Rayon de pointe de la plaquette WSP Eckenradius Insert corner radius		Exécution d'arête et direction de coupe Schneidkante Ausführung und Schneidrichtung Edge type and cutting direction		Géométrie de coupe Spanformgeometrie Cutting geometry															
D	C	G	T	-	11	T3	04	-	FN	-	X8															
		 G = ±0.025 mm M = ±0.05 mm	 T W		 L Ø d [mm]	 E	 R: 003 = 0.03 mm 005 = 0.05 mm 008 = 0.08 mm 01 = 0.1 mm 015 = 0.15 mm 02 = 0.2 mm 04 = 0.4 mm 08 = 0.8 mm				 cf.: Géométrie de coupe Spanformgeometrie Cutting geometry															
	 C = 7°								 FN EN ENP																	
	 C = 80°								 FL / FR																	
	 D = 55°								 ELP / ERP																	
	 V = 35°																									
					<table border="1"> <thead> <tr> <th>L</th> <th>Ø d [mm]</th> </tr> </thead> <tbody> <tr> <td>CC...06</td> <td></td> </tr> <tr> <td>DC...07</td> <td>6.350</td> </tr> <tr> <td>VC... 11</td> <td></td> </tr> <tr> <td>VC... 13</td> <td>7.940</td> </tr> <tr> <td>CC...09</td> <td></td> </tr> <tr> <td>DC... 11</td> <td>9.525</td> </tr> <tr> <td>VC... 16</td> <td></td> </tr> </tbody> </table>	L	Ø d [mm]	CC... 06		DC... 07	6.350	VC... 11		VC... 13	7.940	CC... 09		DC... 11	9.525	VC... 16						
L	Ø d [mm]																									
CC... 06																										
DC... 07	6.350																									
VC... 11																										
VC... 13	7.940																									
CC... 09																										
DC... 11	9.525																									
VC... 16																										



Géométries de coupe
Spanformgeometrien
Cutting geometries

G
tolerance class

Plaquettes en métal dur rectifiées
VHM geschliffene WSP
Carbide ground inserts

Finishing

FN-X8

8°

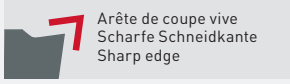

Arête de coupe vive
Scharfe Schneidkante
Sharp edge



Poli
Poliert
Polished

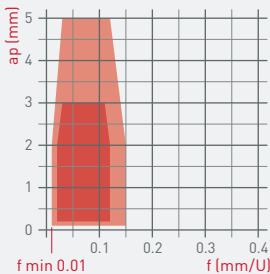



ap (mm)

f (mm/U)



f min 0.01

P	★★★★★
M	★★★★
N	★★★
S	★★★

CCGT	DCGT	VCGT
		
p. 7.19	p. 7.37	p. 7.54

Semi-finishing

ENP-X8

8°

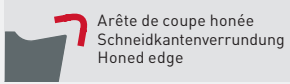

Arête de coupe honée
Schneidkantenverrundung
Honed edge

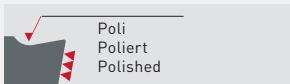

Poli
Poliert
Polished

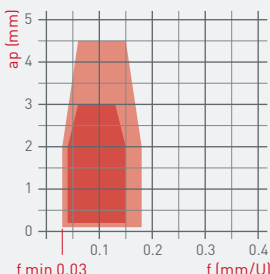



ap (mm)

f (mm/U)



f min 0.03

P	★★★★★
M	★★★
N	★★★
S	★★★

CCGT	DCGT	VCGT
		
p. 7.19	p. 7.37	p. 7.54

Finishing

FN-X17

17°

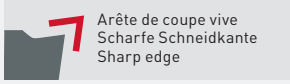

Arête de coupe vive
Scharfe Schneidkante
Sharp edge



Poli
Poliert
Polished

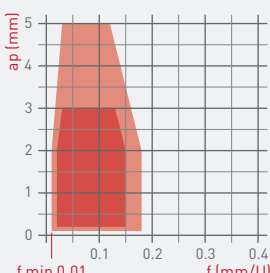



ap (mm)

f (mm/U)



f min 0.01

P	★★★
M	★★★★★
N	★★★★★
S	★★★★★

CCGT	DCGT	VCGT
		
p. 7.20	p. 7.38	p. 7.55

Semi-finishing

ENP-X17

17°

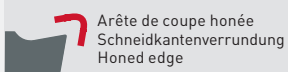

Arête de coupe honée
Schneidkantenverrundung
Honed edge

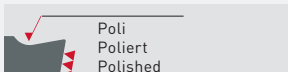

Poli
Poliert
Polished

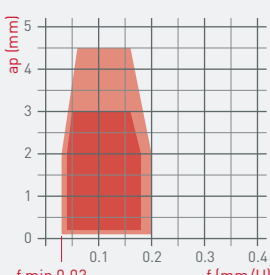



ap (mm)

f (mm/U)

f min 0.03

P	★★★
M	★★★★★
N	★★★
S	★★★★★

CCGT	DCGT	VCGT
		
p. 7.20	p. 7.38	p. 7.55

ISO-LINE

Géométries de coupe
Spanformgeometrien
Cutting geometries

G
tolerance class

Plaquettes en métal dur rectifiées
VHM geschliffene WSP
Carbide ground inserts

FN-X25

Finishing

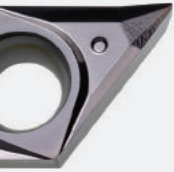

25°

Arête de coupe vive
Scharfe Schneidkante
Sharp edge

Poli
Poliert
Polished

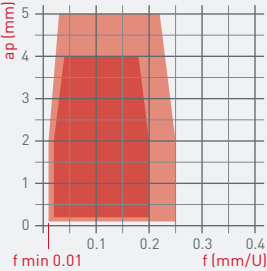

ap (mm)

f (mm/U)

f min 0.01

P	
M	★★★
N	★★★★★
S	★★★★★

CCGT DCGT VCGT



p. 7.21 p. 7.39 p. 7.56

ENP-X25

Semi-finishing



25°

Arête de coupe honée
Schneidkantenverrundung
Honed edge

Poli
Poliert
Polished

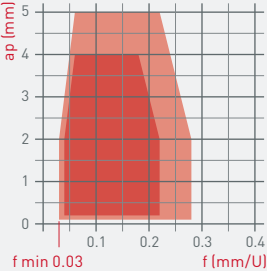

ap (mm)

f (mm/U)

f min 0.03

P	
M	★★★
N	★★★★★
S	★★★★★

CCGT DCGT VCGT



p. 7.21 p. 7.39 p. 7.56

ENP-X20

Semi-finishing



20°

Arête de coupe honée
Schneidkantenverrundung
Honed edge

Poli
Poliert
Polished

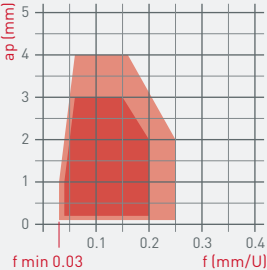

ap (mm)

f (mm/U)

f min 0.03

P	
M	★★★★★
N	★★★★★
S	★★★★★

CCGT DCGT VCGT



p. 7.22 p. 7.40 p. 7.57

Géométries de coupe
Spanformgeometrien
Cutting geometries



M
tolerance class

Plaquettes en métal dur
VHM-Wendepplatten
Carbide inserts

EN-XF3

Semi-finishing

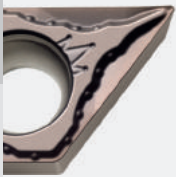
Finishing

12°

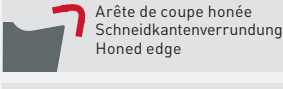

Arête de coupe honée
Schneidkantenverrundung
Honed edge



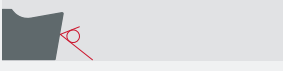
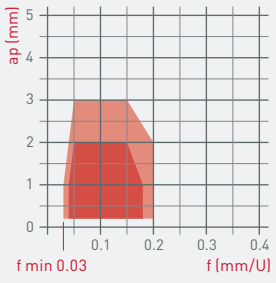



ap (mm)

f (mm/U)

f min 0.03



P	★★★★★
M	★★★★★
N	★★★
S	★★★

CCMT	DCMT	VCMT
		
p. 7.23	p. 7.41	p. 7.58

EN-XF2

Semi-finishing

Finishing

6°

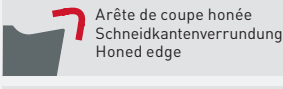

Arête de coupe honée
Schneidkantenverrundung
Honed edge



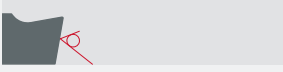
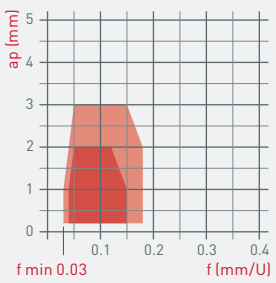



ap (mm)

f (mm/U)



f min 0.03

P	★★★★★
M	★★★
N	
S	★★★

CCMT	DCMT	VCMT
		
p. 7.23	p. 7.41	p. 7.58

EN-MF2

Semi-finishing

8°

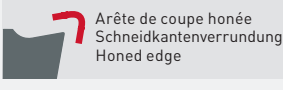

Arête de coupe honée
Schneidkantenverrundung
Honed edge



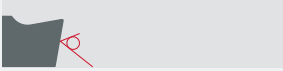
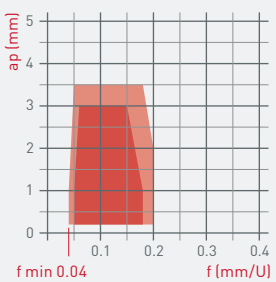

ap (mm)

f (mm/U)

f min 0.04

P	★★★★★
M	★★★★★
N	★★★
S	★★★

CCMT	DCMT
	
p. 7.23	p. 7.41

ISO-LINE

Géométries de coupe
Spanformgeometrien
Cutting geometries

M
tolerance class

Plaquettes en métal dur
VHM-Wendeplatten
Carbide inserts

EN-MF

Semi-finishing

5°

Arête de coupe honée
Schneidkantenverrundung
Honed edge

ap (mm)

f min 0.04 f (mm/U)

P	★★★★★
M	★★★
N	
S	

CCMT DCMT VCMT

p. 7.24 p. 7.42 p. 7.59

EN-HF3

Roughing

Semi-finishing

10°

Arête de coupe honée
Schneidkantenverrundung
Honed edge

ap (mm)

f min 0.06 f (mm/U)

P	★★★★★
M	★★★★★
N	
S	★★★

CCMT DCMT

p. 7.24 p. 7.42

EN-HF

Roughing

Semi-finishing

12°

Arête de coupe honée
Schneidkantenverrundung
Honed edge

ap (mm)

f min 0.08 f (mm/U)

P	★★★★★
M	★★★★★
N	
S	

CCMT DCMT VCMT

p. 7.24 p. 7.42 p. 7.59

Géométries de coupe
Spanformgeometrien
Cutting geometries

G
tolerance class

Plaquettes en métal dur rectifiées
VHM geschliffene WSP
Carbide ground inserts

Super-finishing
FL/FR-X10



10°



Arête de coupe vive
Scharfe Schneidkante
Sharp edge

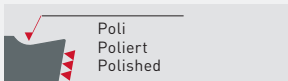

Poli
Poliert
Polished

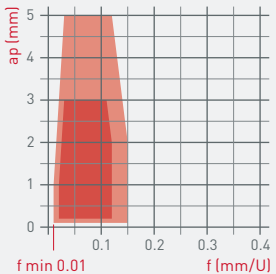

ap (mm)

f min 0.01 f (mm/U)

P	★★★★★
M	★★★★★
N	★★★★★
S	★★★★★

VCGT



p. 752

Semi-finishing
ELP/ERP-X10



10°

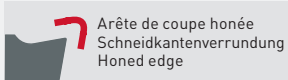

Arête de coupe honée
Schneidkantenverrundung
Honed edge

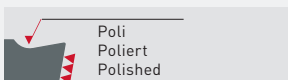

Poli
Poliert
Polished

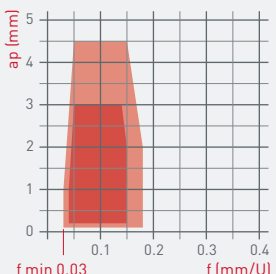

ap (mm)

f min 0.03 f (mm/U)

P	★★★★★
M	★★★★★
N	★★★★
S	★★★★

VCGT



p. 752

Super-finishing
FN-K18



18°

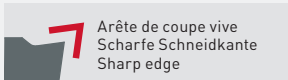

Arête de coupe vive
Scharfe Schneidkante
Sharp edge

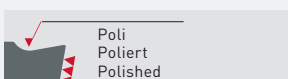

Poli
Poliert
Polished

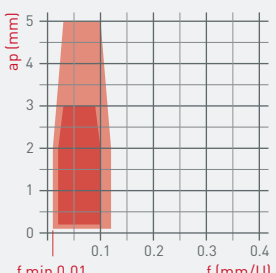

ap (mm)

f min 0.01 f (mm/U)

P	★★★★★
M	★★★★★
N	★★★★★
S	★★★★★

VCGT



p. 753

Finishing
FN-0

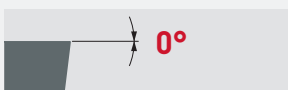

0°

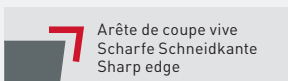

Arête de coupe vive
Scharfe Schneidkante
Sharp edge

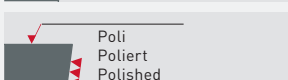

Poli
Poliert
Polished

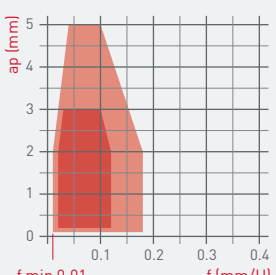

ap (mm)

f min 0.01 f (mm/U)

P	★★★
M	
N	★★★
S	

VCGW



p. 753

Finishing

FN-X8 CERMET



8°

Arête de coupe vive
Scharfe Schneidkante
Sharp edge

Poli
Poliert
Polished

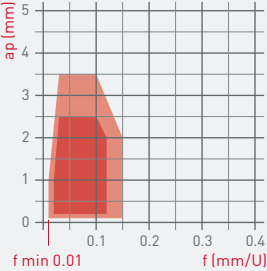

ap (mm)

f (mm/U)

f min 0.01

P	★★★★★
M	★★★
N	
S	

CCGT DCGT VCGT

p. 7.25 p. 7.43 p. 7.60

Semi-finishing

ENP-KX CERMET



8°

Arête de coupe honée
Schneidkantenverrundung
Honed edge

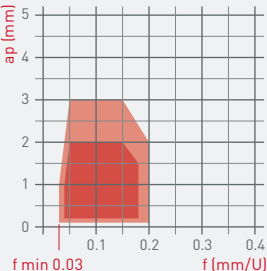

ap (mm)

f (mm/U)

f min 0.03

P	★★★★★
M	★★★
N	
S	

CCGT DCGT

p. 7.25 p. 7.43

Semi-finishing

EN-KM CERMET

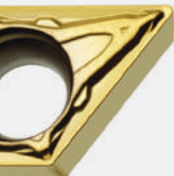

8°

Arête de coupe honée
Schneidkantenverrundung
Honed edge

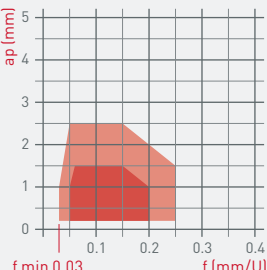

ap (mm)

f (mm/U)

f min 0.03

P	★★★★★
M	★★★
N	
S	

CCMT DCMT

p. 7.26 p. 7.44

Nuances

Sorten

Grades

Nuances Sorten Grades	Domaine d'application Anwendungsbereich Application area	Finishing / light machining	Semi-finishing / medium cut	Roughing / heavy machining	Géométries de coupe disponibles Verfügbare Spanformgeometrien Available cutting geometries	Résistance à l'usure Verschleißfestigkeit Wear resistance	Ténacité, résistance à la rupture Zähigkeit, Bruchwiderstand Toughness, crack resistance	Résistance à la température Bearbeitungswarmfestigkeit Machining heat resistance	Revêtement et couleur Beschichtung und Farbe Coating and colour	Recommandations spéciales Sonder-Empfehlungen Special recommendations
Carbide + PVD										
TiAlN	★★★★★ ★★★★★ ★★★★★ ★★★★	■	■	■	FN/ENP-X8 FN/ENP-X17 FN/ENP-X25 L/R-X10	■■■■■□	■■■■■□	■■■■■□	PVD	
HTA	★★★★★ ★★★★★ ★★★★★ ★★★★	■			FN-X8 FN-X17 FN-X25 L/R-X10 FN-K18 FN-0	■■■■■	■■■■■□	■■■■■□	PVD	
TiN	★★★★ ★★★★ ★★★★★	■	■	■	FN/ENP-X8 FN/ENP-X17 FN/ENP-X25 L/R-X10	■■■■□□	■■■■■□	■■■■□□	PVD	High resistance to edge build up
HTiN	★★★★ ★★★★ ★★★★★	■			FN-K18 FN-0	■■■■■□	■■■■■□	■■■■□□	PVD	High resistance to edge build up
TAC	★★★★★ ★★★★★ ★★★★★ ★★★★	■	■	■	EN-XF3 EN-XF2 EN-MF2 EN-HF	■■■■■□	■■■■■□	■■■■■□	PVD	
HTAC	★★★★★ ★★★★★ ★★★★★ ★★★★	■	■		EN-XF3 EN-XF2 EN-MF2	■■■■■	■■■■■□	■■■■■□	PVD	
TiX	★★★★★ ★★★★★ ★★★			■	EN-HF3	■■■■□□	■■■■■□	■■■■□□	PVD	Easy wear out control with TiN top layer
HTiX	★★★★★ ★★★★★ ★★★★★ ★★★	■	■		ENP-X20 EN-HF3	■■■■■□	■■■■■□	■■■■□□	PVD	Easy wear out control with TiN top layer
Tmax	★★★★★ ★★★★★ ★★★★★ ★★★★	■	■		EN-MF EN-HF	■■■■■□	■■■■■□	■■■■■□	PVD	
ZTA	★★★★★ ★★★★★ ★★★★★	■	■		ENP-X20	■■■■■□	■■■■■□	■■■■■□	PVD	perfect for titanium alloys & superalloys
TiAlX	★★★★★ ★★★★★ ★★★★★	■	■		X8 R-X10 X17 X25	■■■■■□	■■■■■□	■■■■■□	PVD	perfect for titanium alloys & superalloys
HTAX	★★★★★ ★★★★★ ★★★★★	■			X8 R-X10 X17 X25	■■■■■	■■■■■□	■■■■■□	PVD	perfect for titanium alloys & superalloys

ISO-LINE

Nuances

Sorten

Grades

Nuances Sorten Grades	Domaine d'application Anwendungsbereich Application area	Finishing / light machining	Semi-finishing / medium cut	Roughing / heavy machining	Géométries de coupe disponibles Verfügbare Spanformgeometrien Available cutting geometries	Résistance à l'usure Verschleißfestigkeit Wear resistance	Ténacité, résistance à la rupture Zähigkeit, Bruchwiderstand Toughness, crack resistance	Résistance à la température Bearbeitungswarmfestigkeit Machining heat resistance	Revêtement et couleur Beschichtung und Farbe Coating and colour	Recommandations spéciales Sonder-Empfehlungen Special recommendations
Carbide + CVD										
Ti4	★★★★★ ★★★		■	■	EN-MF EN-HF3 EN-HF	■■■■■□	■■■■■□	■■■■■	CVD	
Ti5	★★★★★ ★★★		■	■	EN-MF2 EN-HF	■■■■■□	■■■■■□	■■■■■	CVD	Easy wear out control with TiN top layer
HTi5	★★★★★ ★★★		■	■	EN-XF2 EN-MF2 EN-HF	■■■■■	■■■■□□	■■■■■	CVD	Easy wear out control with TiN top layer
Ti6	★★★ ★★★★★ ★★★★★		■	■	EN-HF3	■■■■■□	■■■■■□	■■■■■	CVD	
Carbide uncoated										
K10	★★★ ★★★		■		FN-X8 FN-X17 FN-X25 ELP-X10/ERP-X10 FN-K18 FN-0	■■■■□□	■■■■□□	■■■■□□	uncoated	
K20	★★ ★★		■		FN/ENP-X8 FN/ENP-X17 FN/ENP-X25 ELP-X10/ERP-X10	■■■■□□	■■■■□□	■■■■□□	uncoated	
CERMET										
CTA	★★★★★ ★★★		■		FN-X8	■■■■■□	■■■■■□	■■■■■	CERMET +PVD	
CT7	★★★★★ ★★★		■	■	ENP-KX EN-KM	■■■■■□	■■■■■□	■■■■■	CERMET + PVD	Easy wear out control with TiN top layer
HCT7	★★★★★ ★★★		■	■	ENP-KX EN-KM	■■■■■	■■■■□□	■■■■■	CERMET + PVD	Easy wear out control with TiN top layer
CN6	★★★★		■		FN-X8 ENP-KX EN-KM	■■■■□□	■■■■■□	■■■■■□	CERMET uncoated	

Porte-outils

Halter

Holders

80°

SCM



SCM

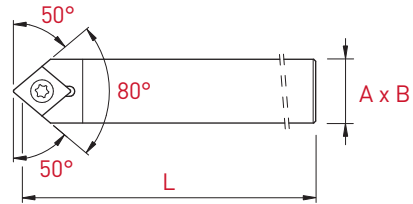

Plaquettes WSP Inserts	A x B	L	Art. N°
CC...-0602..	8 x 8	115	SCMCN-0808X-06
	10 x 10	115	SCMCN-1010X-06
	12 x 12	130	SCMCN-1212X-06
	12 x 12	90	SCMCN-1212G-06
	12.7 x 12.7	130	SCMCN-12.7X-06
	16 x 16	130	SCMCN-1616X-06
	16 x 16	75	SCMCN-1616F-06
CC...-09T3..	12 x 12	130	SCMCN-1212X-09
	12 x 12	90	SCMCN-1212G-09
	12.7 x 12.7	130	SCMCN-12.7X-09
	16 x 16	130	SCMCN-1616X-09
	16 x 16	75	SCMCN-1616F-09
	20 x 20	120	SCMCN-2020X-09



SCA

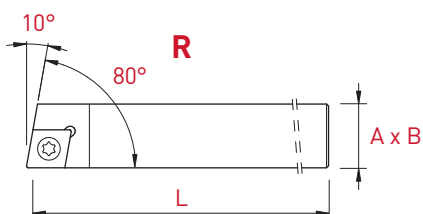

Plaquettes WSP Inserts	A x B	L	Art. N°	Art. N°
CC..-0602..	8 x 8	115	SCACL-0808X-06	SCACR-0808X-06
	10 x 10	115	SCACL-1010X-06	SCACR-1010X-06
	12 x 12	130	SCACL-1212X-06	SCACR-1212X-06
	12 x 12	90	SCACL-1212G-06	SCACR-1212G-06
	12.7 x 12.7	130	SCACL-12.7X-06	SCACR-12.7X-06
	16 x 16	130	SCACL-1616X-06	SCACR-1616X-06
	16 x 16	75	SCACL-1616F-06	SCACR-1616F-06
CC..-09T3..	12 x 12	130	SCACL-1212X-09	SCACR-1212X-09
	12 x 12	90	SCACL-1212G-09	SCACR-1212G-09
	12.7 x 12.7	130	SCACL-12.7X-09	SCACR-12.7X-09
	16 x 16	130	SCACL-1616X-09	SCACR-1616X-09
	16 x 16	75	SCACL-1616F-09	SCACR-1616F-09
	20 x 20	120	SCACL-2020X-09	SCACR-2020X-09

Porte-outils

Halter

Holders

80°

SCL



SCL

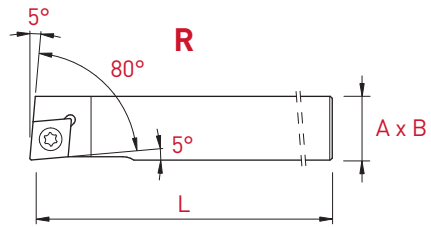

Plaquettes WSP Inserts	A x B	L	Art. N°	Art. N°
CC..-0602..	8 x 8	115	SCLCL-0808X-06	SCLCR-0808X-06
	10 x 10	115	SCLCL-1010X-06	SCLCR-1010X-06
	12 x 12	130	SCLCL-1212X-06	SCLCR-1212X-06
	12 x 12	90	SCLCL-1212G-06	SCLCR-1212G-06
	12.7 x 12.7	130	SCLCL-12.7X-06	SCLCR-12.7X-06
	16 x 16	130	SCLCL-1616X-06	SCLCR-1616X-06
	16 x 16	75	SCLCL-1616F-06	SCLCR-1616F-06
CC..-09T3..	12 x 12	130	SCLCL-1212X-09	SCLCR-1212X-09
	12 x 12	90	SCLCL-1212G-09	SCLCR-1212G-09
	12.7 x 12.7	130	SCLCL-12.7X-09	SCLCR-12.7X-09
	16 x 16	130	SCLCL-1616X-09	SCLCR-1616X-09
	16 x 16	75	SCLCL-1616F-09	SCLCR-1616F-09
	20 x 20	120	SCLCL-2020X-09	SCLCR-2020X-09

ISO-LINE

Porte-outils avec arrosage intégré
 Halter mit integrierter Kühlmittelzufuhr
 Holders with integrated coolant supply

80°

SCL-JET

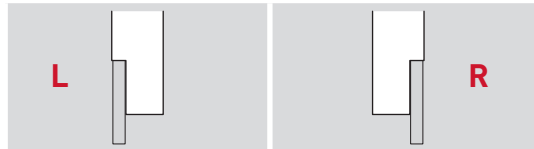
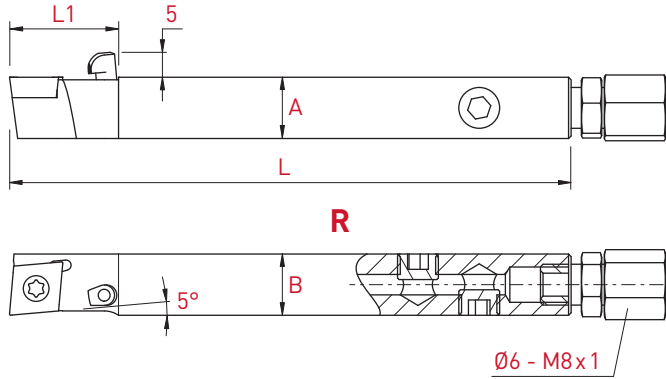

Plaquettes WSP Inserts	A x B	L	L1	Art. N°	Art. N°
CC...-0602..	10 x 10	110	21	SCLCL-1010J-06-JET	SCLCR-1010J-06-JET
	12 x 12	110	21	SCLCL-1212J-06-JET	SCLCR-1212J-06-JET
	12.7 x 12.7	110	21	SCLCL-12.7J-06-JET	SCLCR-12.7J-06-JET
	16 x 16	110	21	SCLCL-1616J-06-JET	SCLCR-1616J-06-JET
CC...-09T3..	12 x 12	110	21	SCLCL-1212J-09-JET	SCLCR-1212J-09-JET
	12.7 x 12.7	110	21	SCLCL-12.7J-09-JET	SCLCR-12.7J-09-JET
	16 x 16	110	21	SCLCL-1616J-09-JET	SCLCR-1616J-09-JET
	20 x 20	110	21	SCLCL-2020J-09-JET	SCLCR-2020J-09-JET

Porte-outils intérieurs amincis

Verjüngte Innenhalter

Thinned internal holders

80°

A-SCLCR/L

new

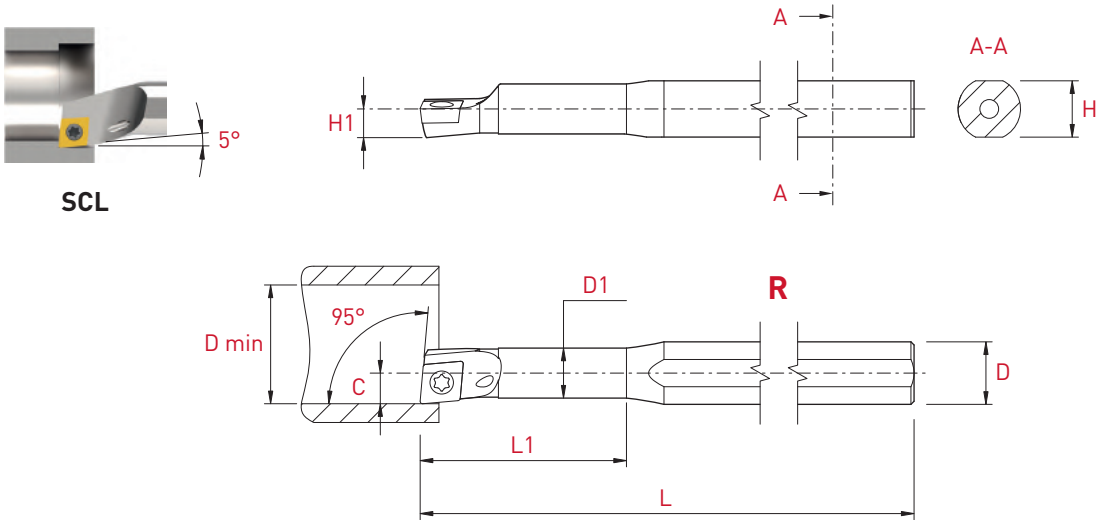

		Acier / Stahl / Steel							L	R
Plaquettes WSP Inserts	D	D min	D1	C	H1	L	L1	H	Art. N°	Art. N°
CC...-0602..	8	8	6	4	4	100	25	7	A0608H-SCLCL-06	A0608H-SCLCR-06
	10	12	8	6	5	110	32	9	A0810J-SCLCL-06	A0810J-SCLCR-06
	12	14	10	7	6	125	38	11	A1012K-SCLCL-06	A1012K-SCLCR-06

Pour barres d'alésage For boring bar Für Borstange	Pièces de rechange Ersatzteile Spare parts	
	Art. N°	Art. N°
A0608H_ / A0810J_	V-M2.5X4.8-T8	C-T8
A1012K_	V-M2.5X5.8-T8	

new

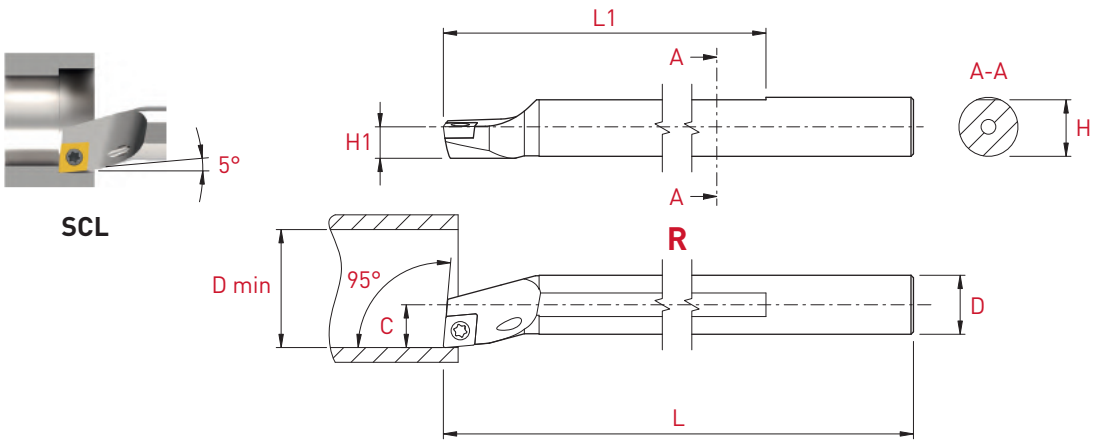

Acier / Stahl / Steel								L	R
-----------------------	--	--	--	--	--	--	--	---	---

Plaquettes WSP Inserts	D	D min	C	H1	L	L1	H	Art. N°	Art. N°
	CC...-0602	8	11	5	4	80	74	7.5	A08F-SCLCL-06
10		13	7	5	100	85	9.5	A10H-SCLCL-06	A10H-SCLCR-06
12		16	9	6	125	95	11.5	A12K-SCLCL-06	A12K-SCLCR-06
CC...-09T3	16	20	11	8	150	117	15.5	A16M-SCLCL-09	A16M-SCLCR-09

Carbure de tungstène / Hartmetall / Solid carbide								Art. N°	Art. N°
---	--	--	--	--	--	--	--	---------	---------

CC...-0602	D	D min	C	H1	L	L1	H	Art. N°	Art. N°
	8	9	5	4	125	-	7.5	E08K-SCLCL 06	E08K-SCLCR 06
10	11	6	5	125	-	9.5	E10K-SCLCL-06	E10K-SCLCR 06	
12	13	8	6	150	-	11.5	E12M-SCLCL 06	E12M-SCLCR 06	

Pour barres d'alésage For boring bar Für Borstange	Pièces de rechange Ersatzteile Spare parts	
	Art. N°	Art. N°
	A08F_ / E08K_ A10H_ / E10H_ A16M_	V-M2.5X4.8-T8 V-M2.5X5.8-T8 V-M3.5X7.2-T15-ISO C-T8 C-T8 C-T15

Plaquettes en métal dur

VHM-Wendeplatten

Solid carbide inserts

80°

CCGT-X8



CCGT
FN-X8

R	Art. N°	PVD			non revêtu unbeschichtet uncoated	
		TiAlN	HTA	TiN	K10	K20
		P M N S	P M N S	P M N		
0.05	CCGT-0602005-FN-X8	■	■	■	■	■
0.1	CCGT-060201-FN-X8	■	■	■	■	■
0.2	CCGT-060202-FN-X8	■	■	■	■	■
0.4	CCGT-060204-FN-X8	■	■	■	■	■
0.05	CCGT-09T3005-FN-X8	■	■	■	■	■
0.1	CCGT-09T301-FN-X8	■	■	■	■	■
0.2	CCGT-09T302-FN-X8	■	■	■	■	■
0.4	CCGT-09T304-FN-X8	■	■	■	■	■



CCGT
ENP-X8

R	Art. N°	PVD		non revêtu unbeschichtet uncoated
		TiAlN	TiN	K20
		P M N S	P M N	N
0.05	CCGT-0602005-ENP-X8	■	■	■
0.1	CCGT-060201-ENP-X8	■	■	■
0.2	CCGT-060202-ENP-X8	■	■	■
0.4	CCGT-060204-ENP-X8	■	■	■
0.05	CCGT-09T3005-ENP-X8	■	■	■
0.1	CCGT-09T301-ENP-X8	■	■	■
0.2	CCGT-09T302-ENP-X8	■	■	■
0.4	CCGT-09T304-ENP-X8	■	■	■





CCGT
FN-X17

R	Art. N°	PVD			non revêtu unbeschichtet uncoated	
		TiAlN	HTA	TiN	K10	K20
		P M N S	P M N S	P M N	<input type="checkbox"/>	<input type="checkbox"/>
0.05	CCGT-0602005-FN-X17	<input checked="" type="checkbox"/>	<input checked="" type="checkbox"/>	<input checked="" type="checkbox"/>	<input checked="" type="checkbox"/>	<input checked="" type="checkbox"/>
0.1	CCGT-060201-FN-X17	<input checked="" type="checkbox"/>	<input checked="" type="checkbox"/>	<input checked="" type="checkbox"/>	<input checked="" type="checkbox"/>	<input checked="" type="checkbox"/>
0.2	CCGT-060202-FN-X17	<input checked="" type="checkbox"/>	<input checked="" type="checkbox"/>	<input checked="" type="checkbox"/>	<input checked="" type="checkbox"/>	<input checked="" type="checkbox"/>
0.4	CCGT-060204-FN-X17	<input checked="" type="checkbox"/>	<input checked="" type="checkbox"/>	<input checked="" type="checkbox"/>	<input checked="" type="checkbox"/>	<input checked="" type="checkbox"/>
0.05	CCGT-09T3005-FN-X17	<input checked="" type="checkbox"/>	<input checked="" type="checkbox"/>	<input checked="" type="checkbox"/>	<input checked="" type="checkbox"/>	<input checked="" type="checkbox"/>
0.1	CCGT-09T301-FN-X17	<input checked="" type="checkbox"/>	<input checked="" type="checkbox"/>	<input checked="" type="checkbox"/>	<input checked="" type="checkbox"/>	<input checked="" type="checkbox"/>
0.2	CCGT-09T302-FN-X17	<input checked="" type="checkbox"/>	<input checked="" type="checkbox"/>	<input checked="" type="checkbox"/>	<input checked="" type="checkbox"/>	<input checked="" type="checkbox"/>
0.4	CCGT-09T304-FN-X17	<input checked="" type="checkbox"/>	<input checked="" type="checkbox"/>	<input checked="" type="checkbox"/>	<input checked="" type="checkbox"/>	<input checked="" type="checkbox"/>
0.8	CCGT-09T308-FN-X17	<input checked="" type="checkbox"/>	<input checked="" type="checkbox"/>	<input checked="" type="checkbox"/>	<input checked="" type="checkbox"/>	<input checked="" type="checkbox"/>

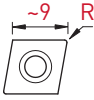

CCGT
ENP-X17

R	Art. N°	PVD		non revêtu unbeschichtet uncoated
		TiAlN	TiN	K20
		P M N S	P M N	<input type="checkbox"/> <input type="checkbox"/> <input checked="" type="checkbox"/>
0.05	CCGT-0602005-ENP-X17	<input checked="" type="checkbox"/>	<input checked="" type="checkbox"/>	<input checked="" type="checkbox"/>
0.1	CCGT-060201-ENP-X17	<input checked="" type="checkbox"/>	<input checked="" type="checkbox"/>	<input checked="" type="checkbox"/>
0.2	CCGT-060202-ENP-X17	<input checked="" type="checkbox"/>	<input checked="" type="checkbox"/>	<input checked="" type="checkbox"/>
0.4	CCGT-060204-ENP-X17	<input checked="" type="checkbox"/>	<input checked="" type="checkbox"/>	<input checked="" type="checkbox"/>
0.05	CCGT-09T3005-ENP-X17	<input checked="" type="checkbox"/>	<input checked="" type="checkbox"/>	<input checked="" type="checkbox"/>
0.1	CCGT-09T301-ENP-X17	<input checked="" type="checkbox"/>	<input checked="" type="checkbox"/>	<input checked="" type="checkbox"/>
0.2	CCGT-09T302-ENP-X17	<input checked="" type="checkbox"/>	<input checked="" type="checkbox"/>	<input checked="" type="checkbox"/>
0.4	CCGT-09T304-ENP-X17	<input checked="" type="checkbox"/>	<input checked="" type="checkbox"/>	<input checked="" type="checkbox"/>
0.8	CCGT-09T308-ENP-X17	<input checked="" type="checkbox"/>	<input checked="" type="checkbox"/>	<input checked="" type="checkbox"/>

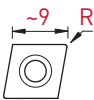

Plaquettes en métal dur
VHM-Wendeplatten
Solid carbide inserts

80°

CCGT-X25

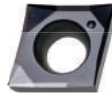

CCGT
FN-X25

R	Art. N°	PVD			non revêtu unbeschichtet uncoated	
		TiAlN	HTA	TiN	K10	K20
		P M N S	P M N S	P M N	<input type="checkbox"/>	<input type="checkbox"/>
0.05	CCGT-0602005-FN-X25	■	■	■	■	■
0.1	CCGT-060201-FN-X25	■	■	■	■	■
0.2	CCGT-060202-FN-X25	■	■	■	■	■
0.4	CCGT-060204-FN-X25	■	■	■	■	■
0.05	CCGT-09T3005-FN-X25	■	■	■	■	■
0.1	CCGT-09T301-FN-X25	■	■	■	■	■
0.2	CCGT-09T302-FN-X25	■	■	■	■	■
0.4	CCGT-09T304-FN-X25	■	■	■	■	■
0.8	CCGT-09T308-FN-X25	■	■	■	■	■

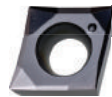
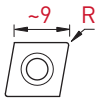

CCGT
ENP-X25

R	Art. N°	PVD		non revêtu unbeschichtet uncoated
		TiAlN	TiN	K20
		P M N S	P M N	<input type="checkbox"/> <input type="checkbox"/> N
0.05	CCGT-0602005-ENP-X25	■	■	■
0.1	CCGT-060201-ENP-X25	■	■	■
0.2	CCGT-060202-ENP-X25	■	■	■
0.4	CCGT-060204-ENP-X25	■	■	■
0.05	CCGT-09T3005-ENP-X25	■	■	■
0.1	CCGT-09T301-ENP-X25	■	■	■
0.2	CCGT-09T302-ENP-X25	■	■	■
0.4	CCGT-09T304-ENP-X25	■	■	■
0.8	CCGT-09T308-ENP-X25	■	■	■



Plaquettes en métal dur

VHM-Wendeplatten

Solid carbide inserts

80°

CCGT-X20



**CCGT
ENP-X20**

PVD



R	H	Art. N°	ZTA	HTiX
<p>~6 R</p>	0.1	CCGT-060201-ENP-X20	■	
	0.2	CCGT-060202-ENP-X20	■	■
	0.4	CCGT-060204-ENP-X20	■	■
<p>~9 R</p>	0.1	CCGT-09T301-ENP-X20	■	
	0.2	CCGT-09T302-ENP-X20	■	■
	0.4	CCGT-09T304-ENP-X20	■	■
	0.8	CCGT-09T308-ENP-X20	■	■

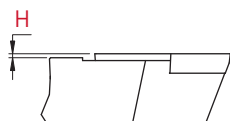

Plaquettes en métal dur

VHM-Wendeplatten

Solid carbide inserts

80°

CCMT-XF3

CCMT-XF2

CCMT-MF2

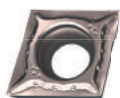

CCMT
EN-XF3

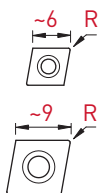

R	Art. N°	PVD	
		TAC	HTAC
0.2	CCMT-060202-EN-XF3	■	■
0.4	CCMT-060204-EN-XF3	■	■
0.2	CCMT-09T302-EN-XF3	■	■
0.4	CCMT-09T304-EN-XF3	■	■

PVD	
P	P
M	M
N	N
S	S
TAC	HTAC



CCMT
EN-XF2

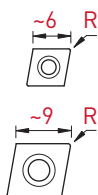

R	Art. N°	PVD		CVD
		TAC	HTAC	HTi5
0.2	CCMT-060202-EN-XF2	■	■	■
0.4	CCMT-060204-EN-XF2	■	■	■
0.2	CCMT-09T302-EN-XF2	■	■	■
0.4	CCMT-09T304-EN-XF2	■	■	■

PVD		CVD
P	P	P
M	M	M
N	N	
S	S	
TAC	HTAC	HTi5

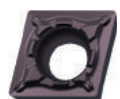

CCMT
EN-MF2

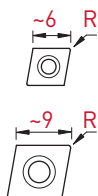

R	Art. N°	PVD		CVD	
		TAC	HTAC	Ti5	HTi5
0.2	CCMT-060202-EN-MF2	■	■	■	■
0.4	CCMT-060204-EN-MF2	■	■	■	■
0.2	CCMT-09T302-EN-MF2	■	■	■	■
0.4	CCMT-09T304-EN-MF2	■	■	■	■
0.8	CCMT-09T308-EN-MF2	■	■	■	■

PVD		CVD	
P	P	P	P
M	M	M	M
N	N		
S	S		
TAC	HTAC	Ti5	HTi5

Plaquettes en métal dur
VHM-Wendeplatten
Solid carbide inserts

80°

CCMT-MF
CCMT-HF3
CCMT-HF



**CCMT
EN-MF**

R	Art. N°	PVD		CVD	
		Tmax	Ti4	Ti4	Ti4
0.2	CCMT-060202-EN-MF	■	■	■	■
0.4	CCMT-060204-EN-MF	■	■	■	■
0.2	CCMT-09T302-EN-MF	■	■	■	■
0.4	CCMT-09T304-EN-MF	■	■	■	■

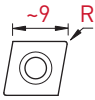

**CCMT
EN-HF3**

R	Art. N°	PVD		CVD	
		TiX	HTiX	Ti6	Ti6
0.2	CCMT-060202-EN-HF3	■	■	■	■
0.4	CCMT-060204-EN-HF3	■	■	■	■
0.2	CCMT-09T302-EN-HF3	■	■	■	■
0.4	CCMT-09T304-EN-HF3	■	■	■	■
0.8	CCMT-09T308-EN-HF3	■	■	■	■



**CCMT
EN-HF**

R	Art. N°	PVD		CVD		
		Tmax	TAC	Ti4	Ti5	HTi5
0.2	CCMT-060202-EN-HF	■	■	■	■	■
0.4	CCMT-060204-EN-HF	■	■	■	■	■
0.8	CCMT-060208-EN-HF	■	■	■	■	■
0.2	CCMT-09T302-EN-HF	■	■	■	■	■
0.4	CCMT-09T304-EN-HF	■	■	■	■	■
0.8	CCMT-09T308-EN-HF	■	■	■	■	■

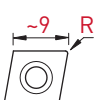

Plaquettes CERMET
 CERMET-Wendeplatten
 CERMET inserts

80°

CCGT-X8
 CCGT-KX



CCGT
 FN-X8

		CERMET	
		PVD	non revêtu unbeschichtet uncoated
		<input checked="" type="checkbox"/> P <input checked="" type="checkbox"/> M <input type="checkbox"/> <input type="checkbox"/>	<input checked="" type="checkbox"/> P <input type="checkbox"/> <input type="checkbox"/> <input type="checkbox"/>
R	Art. N°	CTA	CN6
~6 R	0.05	CCGT-0602005-FN-X8	<input checked="" type="checkbox"/> <input checked="" type="checkbox"/>
	0.1	CCGT-060201-FN-X8	<input checked="" type="checkbox"/> <input checked="" type="checkbox"/>
	0.2	CCGT-060202-FN-X8	<input checked="" type="checkbox"/> <input checked="" type="checkbox"/>
~9 R	0.05	CCGT-09T3005-FN-X8	<input checked="" type="checkbox"/> <input checked="" type="checkbox"/>
	0.1	CCGT-09T301-FN-X8	<input checked="" type="checkbox"/> <input checked="" type="checkbox"/>
	0.2	CCGT-09T302-FN-X8	<input checked="" type="checkbox"/> <input checked="" type="checkbox"/>
	0.4	CCGT-09T304-FN-X8	<input checked="" type="checkbox"/> <input checked="" type="checkbox"/>



CCGT
 ENP-KX

		CERMET		
		PVD		non revêtu unbeschichtet uncoated
		<input checked="" type="checkbox"/> P <input checked="" type="checkbox"/> M <input type="checkbox"/> <input type="checkbox"/>	<input checked="" type="checkbox"/> P <input checked="" type="checkbox"/> M <input type="checkbox"/> <input type="checkbox"/>	<input checked="" type="checkbox"/> P <input type="checkbox"/> <input type="checkbox"/> <input type="checkbox"/>
R	Art. N°	CT7	HCT7	CN6
~6 R	0.1	CCGT-060201-ENP-KX	<input checked="" type="checkbox"/> <input checked="" type="checkbox"/>	<input checked="" type="checkbox"/>
	0.2	CCGT-060202-ENP-KX	<input checked="" type="checkbox"/> <input checked="" type="checkbox"/>	<input checked="" type="checkbox"/>
	0.4	CCGT-060204-ENP-KX	<input checked="" type="checkbox"/> <input checked="" type="checkbox"/>	<input checked="" type="checkbox"/>
~9 R	0.1	CCGT-09T301-ENP-KX	<input checked="" type="checkbox"/> <input checked="" type="checkbox"/>	<input checked="" type="checkbox"/>
	0.2	CCGT-09T302-ENP-KX	<input checked="" type="checkbox"/> <input checked="" type="checkbox"/>	<input checked="" type="checkbox"/>
	0.4	CCGT-09T304-ENP-KX	<input checked="" type="checkbox"/> <input checked="" type="checkbox"/>	<input checked="" type="checkbox"/>





CCMT
 EN-KM

		CERMET		
		PVD		non revêtu unbeschichtet uncoated
		P	P	P
		M	M	
		CT7	HCT7	CN6
R	Art. N°			
0.2	CCMT-060202-EN-KM	■	■	■
0.4	CCMT-060204-EN-KM	■	■	■
0.2	CCMT-09T302-EN-KM	■	■	■
0.4	CCMT-09T304-EN-KM	■	■	■
0.8	CCMT-09T308-EN-KM	■	■	■

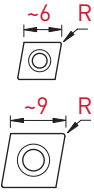

Porte-outils

Halter

Holders

55°

SDN



SDN

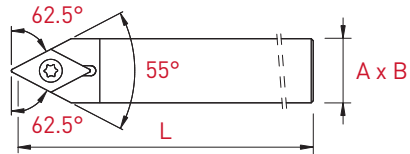

Plaquettes WSP Inserts	A x B	L	Art. N°
DC...-0702..	8 x 8	115	SDNCN-0808X-07
	10 x 10	115	SDNCN-1010X-07
	12 x 12	130	SDNCN-1212X-07
	12 x 12	90	SDNCN-1212G-07
	12.7 x 12.7	130	SDNCN-12.7X-07
	16 x 16	130	SDNCN-1616X-07
	16 x 16	75	SDNCN-1616F-07
DC...-11T3..	12 x 12	130	SDNCN-1212X-11
	12 x 12	90	SDNCN-1212G-11
	12.7 x 12.7	130	SDNCN-12.7X-11
	16 x 16	130	SDNCN-1616X-11
	16 x 16	75	SDNCN-1616F-11
	20 x 20	120	SDNCN-2020X-11



SDA

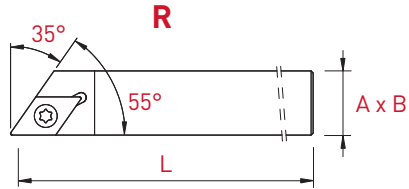

Plaquettes WSP Inserts	A x B	L	Art. N°	Art. N°
DC..-0702..	8 x 8	115	SDACL-0808X-07	SDACR-0808X-07
	10 x 10	115	SDACL-1010X-07	SDACR-1010X-07
	12 x 12	130	SDACL-1212X-07	SDACR-1212X-07
	12 x 12	90	SDACL-1212G-07	SDACR-1212G-07
	12.7 x 12.7	130	SDACL-12.7X-07	SDACR-12.7X-07
	16 x 16	130	SDACL-1616X-07	SDACR-1616X-07
	16 x 16	75	SDACL-1616F-07	SDACR-1616F-07
DC..-11T3..	12 x 12	130	SDACL-1212X-11	SDACR-1212X-11
	12 x 12	90	SDACL-1212G-11	SDACR-1212G-11
	12.7 x 12.7	130	SDACL-12.7X-11	SDACR-12.7X-11
	16 x 16	130	SDACL-1616X-11	SDACR-1616X-11
	16 x 16	75	SDACL-1616F-11	SDACR-1616F-11
	20 x 20	120	SDACL-2020X-11	SDACR-2020X-11

Porte-outils

Halter

Holders

55°

SDJ



SDJ

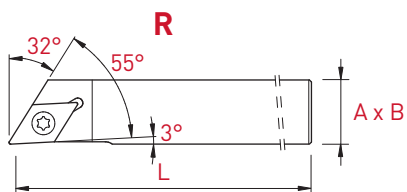

L

R

Plaquettes WSP Inserts	A x B	L	Art. N°	Art. N°
DC...-0702..	8 x 8	115	SDJCL-0808X-07	SDJCR-0808X-07
	10 x 10	115	SDJCL-1010X-07	SDJCR-1010X-07
	12 x 12	130	SDJCL-1212X-07	SDJCR-1212X-07
	12 x 12	90	SDJCL-1212G-07	SDJCR-1212G-07
	12.7 x 12.7	130	SDJCL-12.7X-07	SDJCR-12.7X-07
	16 x 16	130	SDJCL-1616X-07	SDJCR-1616X-07
	16 x 16	75	SDJCL-1616F-07	SDJCR-1616F-07
	20 x 20	120	SDJCL-2020X-07	SDJCR-2020X-07
DC...-11T3..	12 x 12	130	SDJCL-1212X-11	SDJCR-1212X-11
	12 x 12	90	SDJCL-1212G-11	SDJCR-1212G-11
	12.7 x 12.7	130	SDJCL-12.7X-11	SDJCR-12.7X-11
	16 x 16	130	SDJCL-1616X-11	SDJCR-1616X-11
	16 x 16	75	SDJCL-1616F-11	SDJCR-1616F-11
	20 x 20	120	SDJCL-2020X-11	SDJCR-2020X-11

ISO-LINE

Porte-outils avec arrosage intégré
 Halter mit integrierter Kühlmittelzufuhr
 Holders with integrated coolant supply

55°

SDJ-JET

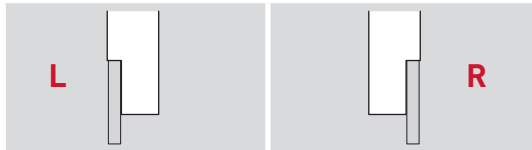
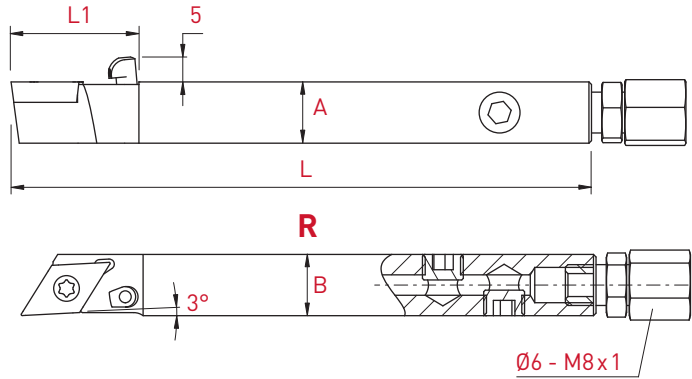

Plaquettes WSP Inserts	A x B	L	L1	Art. N°	Art. N°
DC...-0702..	10 x 10	110	20	SDJCL-1010J-07-JET	SDJCR-1010J-07-JET
	12 x 12	110	20	SDJCL-1212J-07-JET	SDJCR-1212J-07-JET
	12.7 x 12.7	110	20	SDJCL-12.7J-07-JET	SDJCR-12.7J-07-JET
	16 x 16	110	20	SDJCL-1616J-07-JET	SDJCR-1616J-07-JET
	20 x 20	110	20	SDJCL-2020J-07-JET	SDJCR-2020J-07-JET
DC...-11T3..	12 x 12	110	23	SDJCL-1212J-11-JET	SDJCR-1212J-11-JET
	12.7 x 12.7	110	23	SDJCL-12.7J-11-JET	SDJCR-12.7J-11-JET
	16 x 16	110	23	SDJCL-1616J-11-JET	SDJCR-1616J-11-JET
	20 x 20	110	23	SDJCL-2020J-11-JET	SDJCR-2020J-11-JET

Porte-outils

Halter

Holders

55°

SDH



SDH

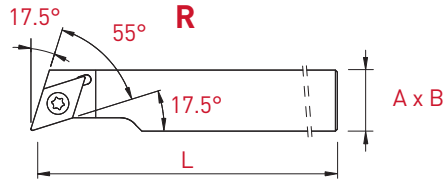

Plaquettes WSP Inserts	A x B	L	Art. N°	Art. N°
DC...-0702..	10 x 10	115	SDHCL-1010X-07	SDHCR-1010X-07
	12 x 12	130	SDHCL-1212X-07	SDHCR-1212X-07
	12 x 12	90	SDHCL-1212G-07	SDHCR-1212G-07
	12.7 x 12.7	130	SDHCL-12.7X-07	SDHCR-12.7X-07
	16 x 16	130	SDHCL-1616X-07	SDHCR-1616X-07
	16 x 16	75	SDHCL-1616F-07	SDHCR-1616F-07
DC...-11T3..	16 x 16	130	SDHCL-1616X-11	SDHCR-1616X-11
	16 x 16	75	SDHCL-1616F-11	SDHCR-1616F-11
	20 x 20	120	SDHCL-2020X-11	SDHCR-2020X-11

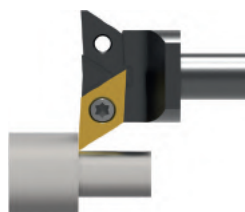

SDU

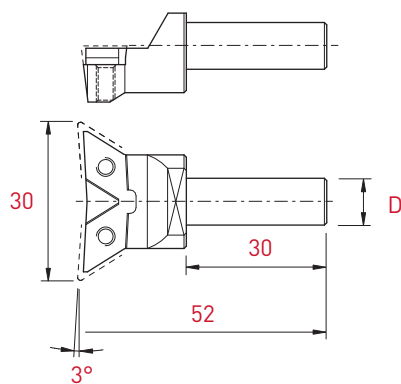

Plaquettes WSP Inserts	D	Art. N°
DC..-11T3..	10	SDUC-D10X-11

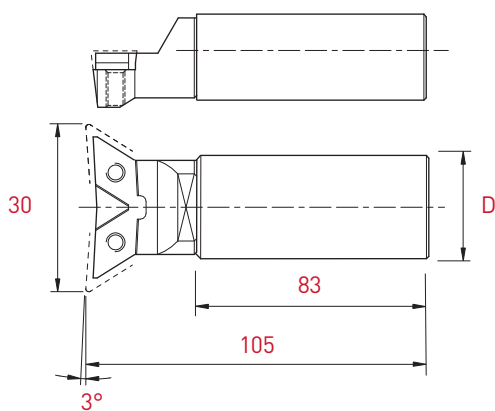

Plaquettes WSP Inserts	D	Art. N°
DC..-11T3..	20	SDUC-D20X-11
	25.4	SDUC-D25.4X-11

Porte-outils intérieurs amincis

Verjüngte Innenhalter

Thinned internal holders

55°

A-SDQCR/L

new

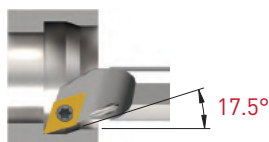

SDQ

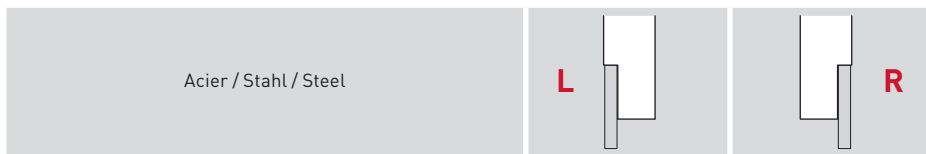
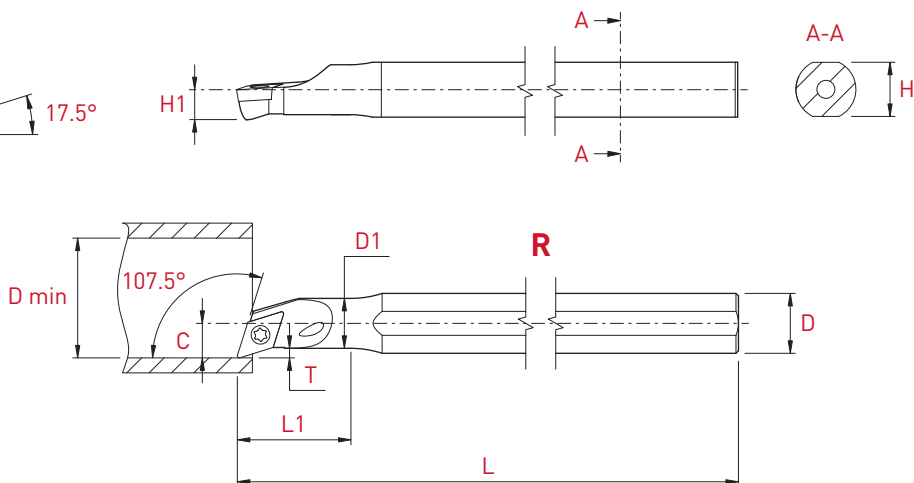

Plaquettes WSP Inserts	Acier / Stahl / Steel										L R	
	D	D min	D1	T	C	H1	L	L1	H	Art. N°	Art. N°	
DC...-0702	10	12.5	8	2.4	7	5	100	22	9	A0810H-SDQCL-07	A0810H-SDQCR-07	
	12	15.5	10	2.9	9	6	125	28	11	A1012K-SDQCL-07	A1012K-SDQCR-07	

Pour barres d'alésage For boring bar Für Borstange	Pièces de rechange Ersatzteile Spare parts	
	Art. N°	Art. N°
A0810H_	V-M2.5X4.8-T8	C-T8
A1012K_	V-M2.5X5.8-T8	

new

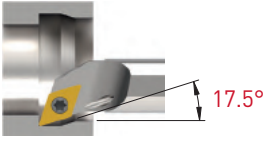

SDQ

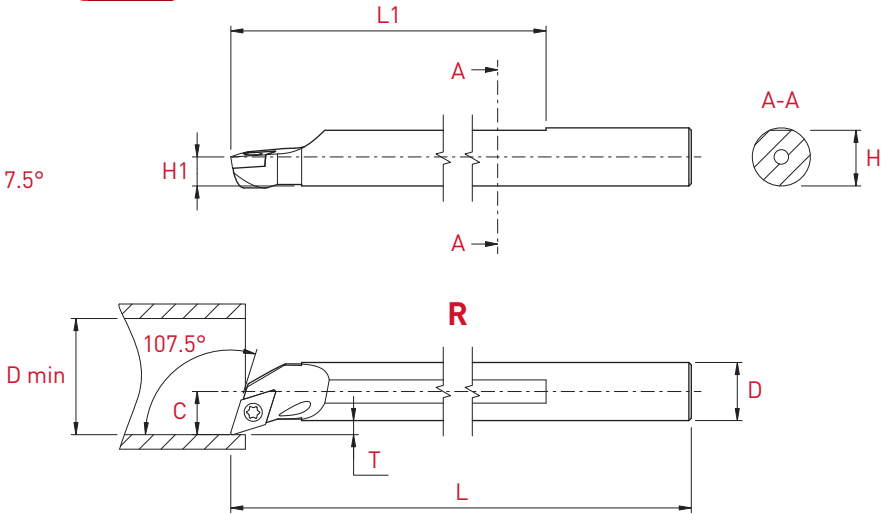

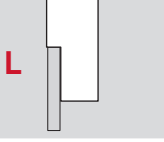
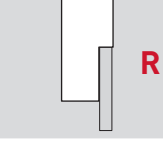
Acier / Stahl / Steel										
Plaquettes WSP Inserts	D	D min	T	C	H1	L	L1	H	Art. N°	Art. N°
DC...-0702	10	14	2.4	7	4.5	100	85	9	A10H-SDQCL-07	A10H-SDQCR-07
	12	17	2.9	9	6	125	95	11.5	A12K-SDQCL-07	A12K-SDQCR-07
	16	21	2.9	11	8	150	117	15.5	A16M-SDQCL-07	A16M-SDQCR-07

Carbure de tungstène / Hartmetall / Solid carbide										
	D	D min	T	C	H1	L	L1	H	Art. N°	Art. N°
DC...-0702	10	13	2.4	7.5	5	125	-	9.5	E10K-SDQCL-07	E10K-SDQCR-07
	12	17	2.9	9	6	150	-	11.5	E12M-SDQCL-07	E12M-SDQCR-07

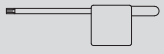
Pièces de rechange Ersatzteile Spare parts	
	
Art. N°	Art. N°
V-M2.5X5.8-T8	C-T8

Porte-outils intérieurs amincis

Verjüngte Innenhalter

Thinned internal holders

55°

A-SDUCR/L

new

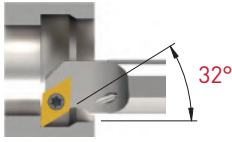

SDU

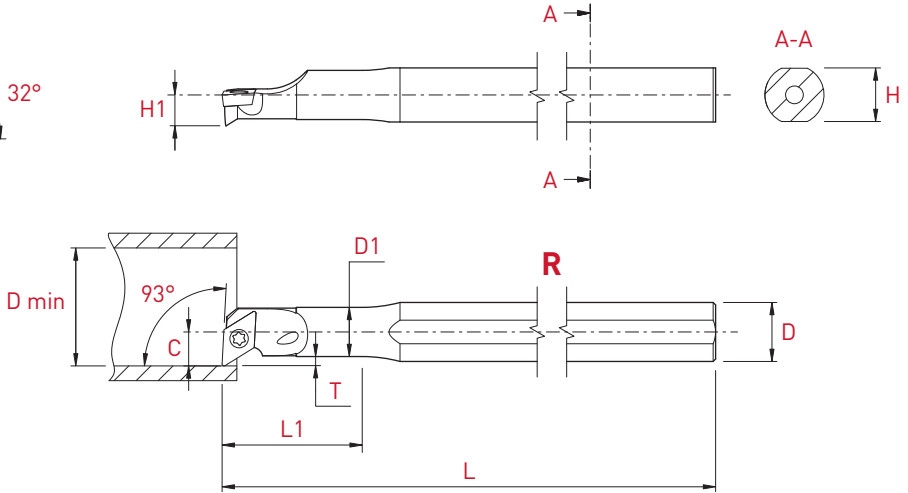

Acier / Stahl / Steel

L

R

Plaquettes WSP Inserts	D	D min	D1	T	C	H1	L	H	Art. N°	Art. N°
	DC...0702	10	12.5	7	1.9	5	100	22	9	A0810H-SDUCL-07
	12	15.5	9	2.9	6	125	28	11	A1012K-SDUCL-07	A1012K-SDUCR-07

Pour barres d'alésage
For boring bar
Für Borstange

Pièces de rechange
Ersatzteile
Spare parts

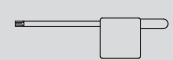
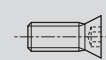

Art. N°

Art. N°

A0810H_

V-M2.5X4.8-T8

C-T8

A1012K_

V-M2.5X5.8-T8

new

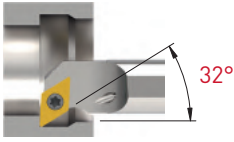

SDU

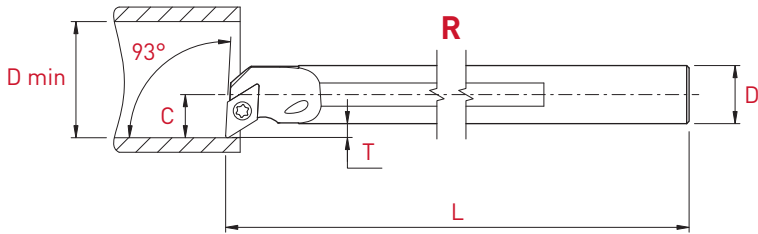
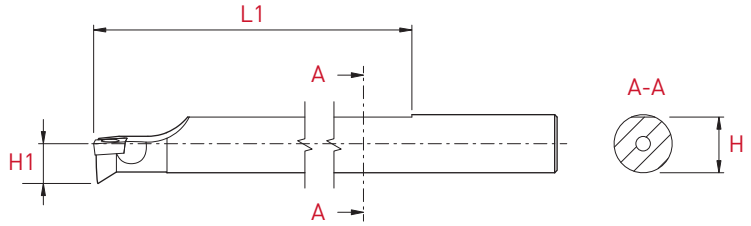

Acier / Stahl / Steel										
-----------------------	--	--	--	--	--	--	--	--	--	--

Plaquettes WSP Inserts	D	D min	T	C	H1	L	L1	H	Art. N°	Art. N°
	DC...-0702	10	14	1.9	7	5	100	85	9.5	A10H-SDUCL-07
12		17	2.9	9	6	125	95	11.5	A12K-SDUCL-07	A12K-SDUCR-07
16		21	2.9	11	8	150	117	15.5	A16M-SDUCL-07	A16M-SDUCR-07

Carbure de tungstène / Hartmetall / Solid carbide									Art. N°	Art. N°
D	D min	T	C	H1	L	L1	H	Art. N°	Art. N°	
DC...-0702	10	14	1.9	7	5	125	-	9.5	E10K-SDUCL-07	E10K-SDUCR-07
	12	17	2.9	9	6	150	-	11.5	E12M-SDUCL-07	E12M-SDUCR-07

Pièces de rechange Ersatzteile Spare parts	
Art. N°	Art. N°
V-M2.5X5.8-T8	C-T8

Plaquettes en métal dur
VHM-Wendepplatten
Solid carbide inserts

55°

DCGT-X8



DCGT
FN-X8

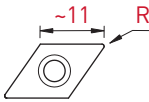
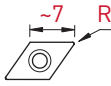

R	Art. N°	PVD					non revêtu unbeschichtet uncoated	
		TiAlN	HTA	TiAlX	HTAX	TiN	K10	K20
		<input type="checkbox"/> P <input type="checkbox"/> M <input type="checkbox"/> N <input type="checkbox"/> S	<input type="checkbox"/> P <input type="checkbox"/> M <input type="checkbox"/> N <input type="checkbox"/> S	<input type="checkbox"/> P <input type="checkbox"/> M <input type="checkbox"/> N <input type="checkbox"/> S	<input type="checkbox"/> P <input type="checkbox"/> M <input type="checkbox"/> N <input type="checkbox"/> S	<input type="checkbox"/> P <input type="checkbox"/> M <input type="checkbox"/> N	<input type="checkbox"/> <input type="checkbox"/>	<input type="checkbox"/> <input type="checkbox"/>
0.05	DCGT-0702005-FN-X8	■	■	■	■	■	■	■
0.08	DCGT-0702008-FN-X8	■	■	■	■	■	■	■
0.1	DCGT-070201-FN-X8	■	■	■	■	■	■	■
0.15	DCGT-0702015-FN-X8	■	■	■	■	■	■	■
0.2	DCGT-070202-FN-X8	■	■	■	■	■	■	■
0.4	DCGT-070204-FN-X8	■	■	■	■	■	■	■
0.05	DCGT-11T3005-FN-X8	■	■	■	■	■	■	■
0.08	DCGT-11T3008-FN-X8	■	■	■	■	■	■	■
0.1	DCGT-11T301-FN-X8	■	■	■	■	■	■	■
0.15	DCGT-11T3015-FN-X8	■	■	■	■	■	■	■
0.2	DCGT-11T302-FN-X8	■	■	■	■	■	■	■
0.4	DCGT-11T304-FN-X8	■	■	■	■	■	■	■



DCGT
ENP-X8

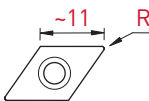
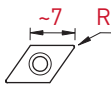

R	Art. N°	PVD		non revêtu unbeschichtet uncoated
		TiAlN	TiN	K20
		<input type="checkbox"/> P <input type="checkbox"/> M <input type="checkbox"/> N <input type="checkbox"/> S	<input type="checkbox"/> P <input type="checkbox"/> M <input type="checkbox"/> N	<input type="checkbox"/> <input type="checkbox"/>
0.05	DCGT-0702005-ENP-X8	■	■	■
0.08	DCGT-0702008-ENP-X8	■	■	■
0.1	DCGT-070201-ENP-X8	■	■	■
0.15	DCGT-0702015-ENP-X8	■	■	■
0.2	DCGT-070202-ENP-X8	■	■	■
0.4	DCGT-070204-ENP-X8	■	■	■
0.05	DCGT-11T3005-ENP-X8	■	■	■
0.08	DCGT-11T3008-ENP-X8	■	■	■
0.1	DCGT-11T301-ENP-X8	■	■	■
0.15	DCGT-11T3015-ENP-X8	■	■	■
0.2	DCGT-11T302-ENP-X8	■	■	■
0.4	DCGT-11T304-ENP-X8	■	■	■



DCGT
FN-X17

R	Art. N°	PVD					non revêtu unbeschichtet uncoated	
		TiAlN	HTA	TiAlX	HTAX	TiN	K10	K20
0.05	DCGT-0702005-FN-X17	<input checked="" type="checkbox"/>	<input checked="" type="checkbox"/>	<input checked="" type="checkbox"/>	<input checked="" type="checkbox"/>	<input checked="" type="checkbox"/>	<input type="checkbox"/>	<input type="checkbox"/>
0.08	DCGT-0702008-FN-X17	<input checked="" type="checkbox"/>	<input checked="" type="checkbox"/>	<input checked="" type="checkbox"/>	<input checked="" type="checkbox"/>	<input checked="" type="checkbox"/>	<input type="checkbox"/>	<input type="checkbox"/>
0.1	DCGT-070201-FN-X17	<input checked="" type="checkbox"/>	<input checked="" type="checkbox"/>	<input checked="" type="checkbox"/>	<input checked="" type="checkbox"/>	<input checked="" type="checkbox"/>	<input type="checkbox"/>	<input type="checkbox"/>
0.15	DCGT-0702015-FN-X17	<input checked="" type="checkbox"/>	<input checked="" type="checkbox"/>	<input checked="" type="checkbox"/>	<input checked="" type="checkbox"/>	<input checked="" type="checkbox"/>	<input type="checkbox"/>	<input type="checkbox"/>
0.2	DCGT-070202-FN-X17	<input checked="" type="checkbox"/>	<input checked="" type="checkbox"/>	<input checked="" type="checkbox"/>	<input checked="" type="checkbox"/>	<input checked="" type="checkbox"/>	<input type="checkbox"/>	<input type="checkbox"/>
0.4	DCGT-070204-FN-X17	<input checked="" type="checkbox"/>	<input checked="" type="checkbox"/>	<input checked="" type="checkbox"/>	<input checked="" type="checkbox"/>	<input checked="" type="checkbox"/>	<input type="checkbox"/>	<input type="checkbox"/>
0.05	DCGT-11T3005-FN-X17	<input checked="" type="checkbox"/>	<input checked="" type="checkbox"/>	<input checked="" type="checkbox"/>	<input checked="" type="checkbox"/>	<input checked="" type="checkbox"/>	<input type="checkbox"/>	<input type="checkbox"/>
0.08	DCGT-11T3008-FN-X17	<input checked="" type="checkbox"/>	<input checked="" type="checkbox"/>	<input checked="" type="checkbox"/>	<input checked="" type="checkbox"/>	<input checked="" type="checkbox"/>	<input type="checkbox"/>	<input type="checkbox"/>
0.1	DCGT-11T301-FN-X17	<input checked="" type="checkbox"/>	<input checked="" type="checkbox"/>	<input checked="" type="checkbox"/>	<input checked="" type="checkbox"/>	<input checked="" type="checkbox"/>	<input type="checkbox"/>	<input type="checkbox"/>
0.15	DCGT-11T3015-FN-X17	<input checked="" type="checkbox"/>	<input checked="" type="checkbox"/>	<input checked="" type="checkbox"/>	<input checked="" type="checkbox"/>	<input checked="" type="checkbox"/>	<input type="checkbox"/>	<input type="checkbox"/>
0.2	DCGT-11T302-FN-X17	<input checked="" type="checkbox"/>	<input checked="" type="checkbox"/>	<input checked="" type="checkbox"/>	<input checked="" type="checkbox"/>	<input checked="" type="checkbox"/>	<input type="checkbox"/>	<input type="checkbox"/>
0.4	DCGT-11T304-FN-X17	<input checked="" type="checkbox"/>	<input checked="" type="checkbox"/>	<input checked="" type="checkbox"/>	<input checked="" type="checkbox"/>	<input checked="" type="checkbox"/>	<input type="checkbox"/>	<input type="checkbox"/>
0.8	DCGT-11T308-FN-X17	<input checked="" type="checkbox"/>	<input checked="" type="checkbox"/>	<input checked="" type="checkbox"/>	<input checked="" type="checkbox"/>	<input checked="" type="checkbox"/>	<input type="checkbox"/>	<input type="checkbox"/>

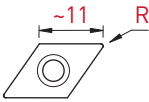
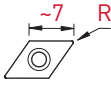

DCGT
ENP-X17

R	Art. N°	PVD		non revêtu unbeschichtet uncoated
		TiAlN	TiN	K20
0.05	DCGT-0702005-ENP-X17	<input checked="" type="checkbox"/>	<input checked="" type="checkbox"/>	<input type="checkbox"/>
0.08	DCGT-0702008-ENP-X17	<input checked="" type="checkbox"/>	<input checked="" type="checkbox"/>	<input type="checkbox"/>
0.1	DCGT-070201-ENP-X17	<input checked="" type="checkbox"/>	<input checked="" type="checkbox"/>	<input type="checkbox"/>
0.15	DCGT-0702015-ENP-X17	<input checked="" type="checkbox"/>	<input checked="" type="checkbox"/>	<input type="checkbox"/>
0.2	DCGT-070202-ENP-X17	<input checked="" type="checkbox"/>	<input checked="" type="checkbox"/>	<input type="checkbox"/>
0.4	DCGT-070204-ENP-X17	<input checked="" type="checkbox"/>	<input checked="" type="checkbox"/>	<input type="checkbox"/>
0.05	DCGT-11T3005-ENP-X17	<input checked="" type="checkbox"/>	<input checked="" type="checkbox"/>	<input type="checkbox"/>
0.08	DCGT-11T3008-ENP-X17	<input checked="" type="checkbox"/>	<input checked="" type="checkbox"/>	<input type="checkbox"/>
0.1	DCGT-11T301-ENP-X17	<input checked="" type="checkbox"/>	<input checked="" type="checkbox"/>	<input type="checkbox"/>
0.15	DCGT-11T3015-ENP-X17	<input checked="" type="checkbox"/>	<input checked="" type="checkbox"/>	<input type="checkbox"/>
0.2	DCGT-11T302-ENP-X17	<input checked="" type="checkbox"/>	<input checked="" type="checkbox"/>	<input type="checkbox"/>
0.4	DCGT-11T304-ENP-X17	<input checked="" type="checkbox"/>	<input checked="" type="checkbox"/>	<input type="checkbox"/>
0.8	DCGT-11T308-ENP-X17	<input checked="" type="checkbox"/>	<input checked="" type="checkbox"/>	<input type="checkbox"/>

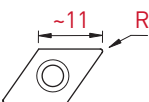
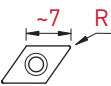

Plaquettes en métal dur

VHM-Wendeplatten

Solid carbide inserts

55°

DCGT-X25



DCGT
FN-X25

R	Art. N°	PVD			non revêtu unbeschichtet uncoated	
		TiAlN	HTA	TiN	K10	K20
		<input type="checkbox"/>	<input type="checkbox"/>	<input type="checkbox"/>	<input type="checkbox"/>	<input type="checkbox"/>
		<input type="checkbox"/>	<input type="checkbox"/>	<input type="checkbox"/>	<input type="checkbox"/>	<input type="checkbox"/>
		<input type="checkbox"/>	<input type="checkbox"/>	<input type="checkbox"/>	<input type="checkbox"/>	<input type="checkbox"/>
		<input type="checkbox"/>	<input type="checkbox"/>	<input type="checkbox"/>	<input type="checkbox"/>	<input type="checkbox"/>
0.05	DCGT-0702005-FN-X25	<input checked="" type="checkbox"/>	<input checked="" type="checkbox"/>	<input checked="" type="checkbox"/>	<input checked="" type="checkbox"/>	<input checked="" type="checkbox"/>
0.1	DCGT-070201-FN-X25	<input checked="" type="checkbox"/>	<input checked="" type="checkbox"/>	<input checked="" type="checkbox"/>	<input checked="" type="checkbox"/>	<input checked="" type="checkbox"/>
0.2	DCGT-070202-FN-X25	<input checked="" type="checkbox"/>	<input checked="" type="checkbox"/>	<input checked="" type="checkbox"/>	<input checked="" type="checkbox"/>	<input checked="" type="checkbox"/>
0.4	DCGT-070204-FN-X25	<input checked="" type="checkbox"/>	<input checked="" type="checkbox"/>	<input checked="" type="checkbox"/>	<input checked="" type="checkbox"/>	<input checked="" type="checkbox"/>
0.05	DCGT-11T3005-FN-X25	<input checked="" type="checkbox"/>	<input checked="" type="checkbox"/>	<input checked="" type="checkbox"/>	<input checked="" type="checkbox"/>	<input checked="" type="checkbox"/>
0.1	DCGT-11T301-FN-X25	<input checked="" type="checkbox"/>	<input checked="" type="checkbox"/>	<input checked="" type="checkbox"/>	<input checked="" type="checkbox"/>	<input checked="" type="checkbox"/>
0.2	DCGT-11T302-FN-X25	<input checked="" type="checkbox"/>	<input checked="" type="checkbox"/>	<input checked="" type="checkbox"/>	<input checked="" type="checkbox"/>	<input checked="" type="checkbox"/>
0.4	DCGT-11T304-FN-X25	<input checked="" type="checkbox"/>	<input checked="" type="checkbox"/>	<input checked="" type="checkbox"/>	<input checked="" type="checkbox"/>	<input checked="" type="checkbox"/>
0.8	DCGT-11T308-FN-X25	<input checked="" type="checkbox"/>	<input checked="" type="checkbox"/>	<input checked="" type="checkbox"/>	<input checked="" type="checkbox"/>	<input checked="" type="checkbox"/>

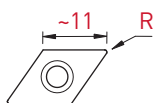
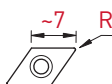

DCGT
ENP-X25

R	Art. N°	PVD			non revêtu unbeschichtet uncoated
		TiAlN	TiAlX	TiN	K20
		<input type="checkbox"/>	<input type="checkbox"/>	<input type="checkbox"/>	<input type="checkbox"/>
		<input type="checkbox"/>	<input type="checkbox"/>	<input type="checkbox"/>	<input type="checkbox"/>
		<input type="checkbox"/>	<input type="checkbox"/>	<input type="checkbox"/>	<input type="checkbox"/>
		<input type="checkbox"/>	<input type="checkbox"/>	<input type="checkbox"/>	<input type="checkbox"/>
0.05	DCGT-0702005-ENP-X25	<input checked="" type="checkbox"/>	<input checked="" type="checkbox"/>	<input checked="" type="checkbox"/>	<input checked="" type="checkbox"/>
0.1	DCGT-070201-ENP-X25	<input checked="" type="checkbox"/>	<input checked="" type="checkbox"/>	<input checked="" type="checkbox"/>	<input checked="" type="checkbox"/>
0.2	DCGT-070202-ENP-X25	<input checked="" type="checkbox"/>	<input checked="" type="checkbox"/>	<input checked="" type="checkbox"/>	<input checked="" type="checkbox"/>
0.4	DCGT-070204-ENP-X25	<input checked="" type="checkbox"/>	<input checked="" type="checkbox"/>	<input checked="" type="checkbox"/>	<input checked="" type="checkbox"/>
0.05	DCGT-11T3005-ENP-X25	<input checked="" type="checkbox"/>	<input checked="" type="checkbox"/>	<input checked="" type="checkbox"/>	<input checked="" type="checkbox"/>
0.1	DCGT-11T301-ENP-X25	<input checked="" type="checkbox"/>	<input checked="" type="checkbox"/>	<input checked="" type="checkbox"/>	<input checked="" type="checkbox"/>
0.2	DCGT-11T302-ENP-X25	<input checked="" type="checkbox"/>	<input checked="" type="checkbox"/>	<input checked="" type="checkbox"/>	<input checked="" type="checkbox"/>
0.4	DCGT-11T304-ENP-X25	<input checked="" type="checkbox"/>	<input checked="" type="checkbox"/>	<input checked="" type="checkbox"/>	<input checked="" type="checkbox"/>
0.8	DCGT-11T308-ENP-X25	<input checked="" type="checkbox"/>	<input checked="" type="checkbox"/>	<input checked="" type="checkbox"/>	<input checked="" type="checkbox"/>

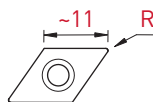
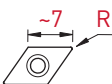



DCCT
ENP-X20

PVD	
<input type="checkbox"/>	<input type="checkbox"/>
<input checked="" type="checkbox"/> M	<input checked="" type="checkbox"/> M
<input checked="" type="checkbox"/> N	<input checked="" type="checkbox"/> N
<input checked="" type="checkbox"/> S	<input checked="" type="checkbox"/> S
ZTA	HTiX

R	H	Art. N°	ZTA	HTiX
0.1	0.2	DCCT-070201-ENP-X20	■	
0.2	0.2	DCCT-070202-ENP-X20	■	■
0.4	0.2	DCCT-070204-ENP-X20	■	■
0.1	0.25	DCCT-11T301-ENP-X20	■	
0.2	0.25	DCCT-11T302-ENP-X20	■	■
0.4	0.25	DCCT-11T304-ENP-X20	■	■
0.8	0.25	DCCT-11T308-ENP-X20	■	■

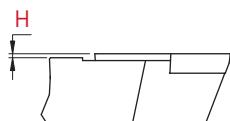
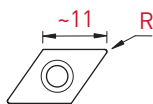
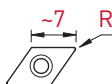

Plaquettes en métal dur

VHM-Wendepplatten

Solid carbide inserts

55°

DCMT-XF3

DCMT-XF2

DCMT-MF2

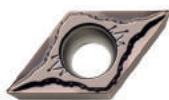

DCMT
EN-XF3

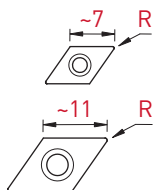

R	Art. N°	PVD	
		TAC	HTAC
0.2	DCMT-070202-EN-XF3	<input checked="" type="checkbox"/>	<input checked="" type="checkbox"/>
0.4	DCMT-070204-EN-XF3	<input checked="" type="checkbox"/>	<input checked="" type="checkbox"/>
0.2	DCMT-11T302-EN-XF3	<input checked="" type="checkbox"/>	<input checked="" type="checkbox"/>
0.4	DCMT-11T304-EN-XF3	<input checked="" type="checkbox"/>	<input checked="" type="checkbox"/>

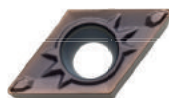

DCMT
EN-XF2

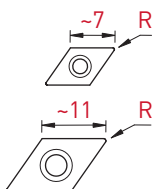

R	Art. N°	PVD		CVD
		TAC	HTAC	HT15
0.2	DCMT-070202-EN-XF2	<input checked="" type="checkbox"/>	<input checked="" type="checkbox"/>	<input checked="" type="checkbox"/>
0.4	DCMT-070204-EN-XF2	<input checked="" type="checkbox"/>	<input checked="" type="checkbox"/>	<input checked="" type="checkbox"/>
0.2	DCMT-11T302-EN-XF2	<input checked="" type="checkbox"/>	<input checked="" type="checkbox"/>	<input checked="" type="checkbox"/>
0.4	DCMT-11T304-EN-XF2	<input checked="" type="checkbox"/>	<input checked="" type="checkbox"/>	<input checked="" type="checkbox"/>



DCMT
EN-MF2

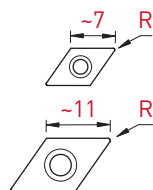

R	Art. N°	PVD		CVD	
		TAC	HTAC	Ti5	HT15
0.2	DCMT-070202-EN-MF2	<input checked="" type="checkbox"/>	<input checked="" type="checkbox"/>	<input checked="" type="checkbox"/>	<input checked="" type="checkbox"/>
0.4	DCMT-070204-EN-MF2	<input checked="" type="checkbox"/>	<input checked="" type="checkbox"/>	<input checked="" type="checkbox"/>	<input checked="" type="checkbox"/>
0.2	DCMT-11T302-EN-MF2	<input checked="" type="checkbox"/>	<input checked="" type="checkbox"/>	<input checked="" type="checkbox"/>	<input checked="" type="checkbox"/>
0.4	DCMT-11T304-EN-MF2	<input checked="" type="checkbox"/>	<input checked="" type="checkbox"/>	<input checked="" type="checkbox"/>	<input checked="" type="checkbox"/>
0.8	DCMT-11T308-EN-MF2	<input checked="" type="checkbox"/>	<input checked="" type="checkbox"/>	<input checked="" type="checkbox"/>	<input checked="" type="checkbox"/>

ISO-LINE

Plaquettes en métal dur
VHM-Wendplatten
Solid carbide inserts

55°

DCMT-MF
DCMT-HF3
DCMT-HF



**DCMT
EN-MF**

R	Art. N°	PVD		CVD	
		Tmax	Ti4	Ti4	Ti4
0.2	DCMT-070202-EN-MF	■	■	■	■
0.4	DCMT-070204-EN-MF	■	■	■	■
0.2	DCMT-11T302-EN-MF	■	■	■	■
0.4	DCMT-11T304-EN-MF	■	■	■	■

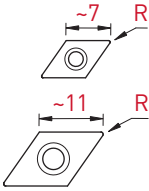

**DCMT
EN-HF3**

R	Art. N°	PVD		CVD	
		TiX	HTiX	Ti6	Ti6
0.2	DCMT-070202-EN-HF3	■	■	■	■
0.4	DCMT-070204-EN-HF3	■	■	■	■
0.2	DCMT-11T302-EN-HF3	■	■	■	■
0.4	DCMT-11T304-EN-HF3	■	■	■	■
0.8	DCMT-11T308-EN-HF3	■	■	■	■

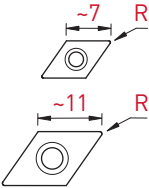

**DCMT
EN-HF**

R	Art. N°	PVD		CVD		
		Tmax	TAC	Ti4	Ti5	HTi5
0.2	DCMT-070202-EN-HF	■	■	■	■	■
0.4	DCMT-070204-EN-HF	■	■	■	■	■
0.8	DCMT-070208-EN-HF	■	■	■	■	■
0.2	DCMT-11T302-EN-HF	■	■	■	■	■
0.4	DCMT-11T304-EN-HF	■	■	■	■	■
0.8	DCMT-11T308-EN-HF	■	■	■	■	■

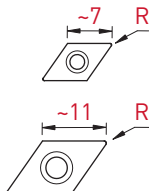

Plaquettes CERMET
 CERMET-Wendeplatten
 CERMET inserts

55°

DCGT-X8
 DCGT-KX



DCGT
 FN-X8

		CERMET	
		PVD	non revêtu unbeschichtet uncoated
		<input checked="" type="checkbox"/> P <input checked="" type="checkbox"/> M <input type="checkbox"/>	<input checked="" type="checkbox"/> P <input type="checkbox"/> <input type="checkbox"/>
		<input type="checkbox"/>	<input type="checkbox"/>
		<input type="checkbox"/>	<input type="checkbox"/>
R	Art. N°	CTA	CN6
0.05	DCGT-0702005-FN-X8	<input checked="" type="checkbox"/>	<input checked="" type="checkbox"/>
0.1	DCGT-070201-FN-X8	<input checked="" type="checkbox"/>	<input checked="" type="checkbox"/>
0.2	DCGT-070202-FN-X8	<input checked="" type="checkbox"/>	<input checked="" type="checkbox"/>
0.05	DCGT-11T3005-FN-X8	<input checked="" type="checkbox"/>	<input checked="" type="checkbox"/>
0.1	DCGT-11T301-FN-X8	<input checked="" type="checkbox"/>	<input checked="" type="checkbox"/>
0.2	DCGT-11T302-FN-X8	<input checked="" type="checkbox"/>	<input checked="" type="checkbox"/>
0.4	DCGT-11T304-FN-X8	<input checked="" type="checkbox"/>	<input checked="" type="checkbox"/>

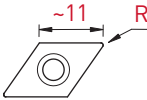
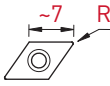

DCGT
 ENP-KX

		CERMET	
		PVD	non revêtu unbeschichtet uncoated
		<input checked="" type="checkbox"/> P <input checked="" type="checkbox"/> M <input type="checkbox"/>	<input checked="" type="checkbox"/> P <input type="checkbox"/> <input type="checkbox"/>
		<input type="checkbox"/>	<input type="checkbox"/>
		<input type="checkbox"/>	<input type="checkbox"/>
R	Art. N°	CT7	HCT7
0.1	DCGT-070201-ENP-KX	<input checked="" type="checkbox"/>	<input checked="" type="checkbox"/>
0.2	DCGT-070202-ENP-KX	<input checked="" type="checkbox"/>	<input checked="" type="checkbox"/>
0.4	DCGT-070204-ENP-KX	<input checked="" type="checkbox"/>	<input checked="" type="checkbox"/>
0.1	DCGT-11T301-ENP-KX	<input checked="" type="checkbox"/>	<input checked="" type="checkbox"/>
0.2	DCGT-11T302-ENP-KX	<input checked="" type="checkbox"/>	<input checked="" type="checkbox"/>
0.4	DCGT-11T304-ENP-KX	<input checked="" type="checkbox"/>	<input checked="" type="checkbox"/>

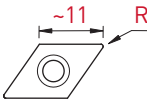
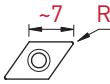

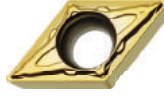

DCMT
 EN-KM

		CERMET		
		PVD		non revêtu unbeschichtet uncoated
		P M	P M	P
		<input type="checkbox"/>	<input type="checkbox"/>	<input type="checkbox"/>
		<input type="checkbox"/>	<input type="checkbox"/>	<input type="checkbox"/>
		CT7	HCT7	CN6
R	Art. N°	<input type="checkbox"/>	<input type="checkbox"/>	<input type="checkbox"/>
0.2	DCMT-070202-EN-KM	<input checked="" type="checkbox"/>	<input checked="" type="checkbox"/>	<input checked="" type="checkbox"/>
0.4	DCMT-070204-EN-KM	<input checked="" type="checkbox"/>	<input checked="" type="checkbox"/>	<input checked="" type="checkbox"/>
0.2	DCMT-11T302-EN-KM	<input checked="" type="checkbox"/>	<input checked="" type="checkbox"/>	<input checked="" type="checkbox"/>
0.4	DCMT-11T304-EN-KM	<input checked="" type="checkbox"/>	<input checked="" type="checkbox"/>	<input checked="" type="checkbox"/>
0.8	DCMT-11T308-EN-KM	<input checked="" type="checkbox"/>	<input checked="" type="checkbox"/>	<input checked="" type="checkbox"/>

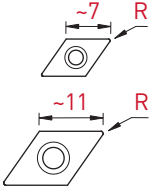

Porte-outils

Halter

Holders

35°

SVV



SVV

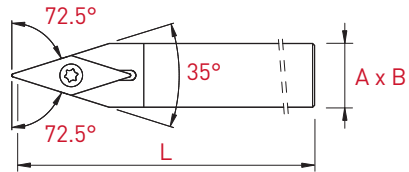

Plaquettes WSP Inserts	A x B	L	Art. N°
VC...1103..	8 x 8	115	SVVCN-0808X-11
	10 x 10	115	SVVCN-1010X-11
	12 x 12	130	SVVCN-1212X-11
	12 x 12	90	SVVCN-1212G-11
	12.7 x 12.7	130	SVVCN-12.7X-11
	16 x 16	130	SVVCN-1616X-11
	16 x 16	75	SVVCN-1616F-11
	20 x 20	120	SVVCN-2020X-11
VC...1303..	8 x 10	115	SVVCN-0810X-13
	10 x 10	115	SVVCN-1010X-13
	12 x 12	130	SVVCN-1212X-13
	12 x 12	90	SVVCN-1212G-13
	12.7 x 12.7	130	SVVCN-12.7X-13
	16 x 16	130	SVVCN-1616X-13
	16 x 16	75	SVVCN-1616F-13
	20 x 20	120	SVVCN-2020X-13
VC...1604..	12 x 12	130	SVVCN-1212X-16
	12 x 12	90	SVVCN-1212G-16
	12.7 x 12.7	130	SVVCN-12.7X-16
	16 x 16	130	SVVCN-1616X-16
	16 x 16	75	SVVCN-1616F-16
	20 x 20	120	SVVCN-2020X-16



SVA

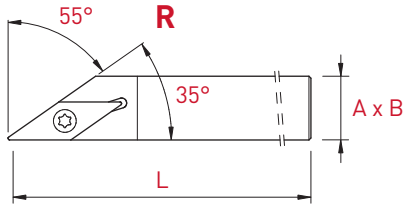

Plaquettes WSP Inserts	A x B	L	Art. N°	Art. N°
VC...1103..	8 x 8	115	SVACL-0808X-11	SVACR-0808X-11
	10 x 10	115	SVACL-1010X-11	SVACR-1010X-11
	12 x 12	130	SVACL-1212X-11	SVACR-1212X-11
	12 x 12	90	SVACL-1212G-11	SVACR-1212G-11
	12.7 x 12.7	130	SVACL-12.7X-11	SVACR-12.7X-11
	16 x 16	130	SVACL-1616X-11	SVACR-1616X-11
	16 x 16	75	SVACL-1616F-11	SVACR-1616F-11
	20 x 20	120	SVACL-2020X-11	SVACR-2020X-11
VC...1604..	12 x 12	130	SVACL-1212X-16	SVACR-1212X-16
	12 x 12	90	SVACL-1212G-16	SVACR-1212G-16
	12.7 x 12.7	130	SVACL-12.7X-16	SVACR-12.7X-16
	16 x 16	130	SVACL-1616X-16	SVACR-1616X-16
	16 x 16	75	SVACL-1616F-16	SVACR-1616F-16
	20 x 20	120	SVACL-2020X-16	SVACR-2020X-16

Porte-outils

Halter

Holders

35°

SVJ



SVJ

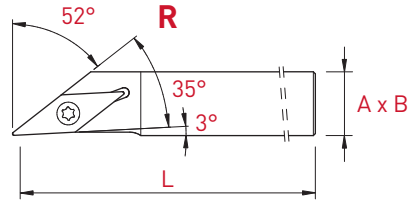

Plaquettes WSP Inserts	A x B	L	Art. N°	Art. N°
VC...1103..	8 x 8	115	SVJCL-0808X-11	SVJCR-0808X-11
	10 x 10	115	SVJCL-1010X-11	SVJCR-1010X-11
	12 x 12	130	SVJCL-1212X-11	SVJCR-1212X-11
	12 x 12	90	SVJCL-1212G-11	SVJCR-1212G-11
	12.7 x 12.7	130	SVJCL-12.7X-11	SVJCR-12.7X-11
	16 x 16	130	SVJCL-1616X-11	SVJCR-1616X-11
	16 x 16	75	SVJCL-1616F-11	SVJCR-1616F-11
	20 x 20	120	SVJCL-2020X-11	SVJCR-2020X-11
VC...1303..	8 x 10	115	SVJCL-0810X-13	SVJCR-0810X-13
	10 x 10	115	SVJCL-1010X-13	SVJCR-1010X-13
	12 x 12	130	SVJCL-1212X-13	SVJCR-1212X-13
	12 x 12	90	SVJCL-1212G-13	SVJCR-1212G-13
	12.7 x 12.7	130	SVJCL-12.7X-13	SVJCR-12.7X-13
	16 x 16	130	SVJCL-1616X-13	SVJCR-1616X-13
	16 x 16	75	SVJCL-1616F-13	SVJCR-1616F-13
	20 x 20	120	SVJCL-2020X-13	SVJCR-2020X-13
VC...1604..	12 x 12	130	SVJCL-1212X-16	SVJCR-1212X-16
	12 x 12	90	SVJCL-1212G-16	SVJCR-1212G-16
	12.7 x 12.7	130	SVJCL-12.7X-16	SVJCR-12.7X-16
	16 x 16	130	SVJCL-1616X-16	SVJCR-1616X-16
	16 x 16	75	SVJCL-1616F-16	SVJCR-1616F-16
	20 x 20	120	SVJCL-2020X-16	SVJCR-2020X-16

ISO-LINE

Porte-outils avec arrosage intégré
 Halter mit integrierter Kühlmittelzufuhr
 Holders with integrated coolant supply

35°

SVJ-JET



SVJ

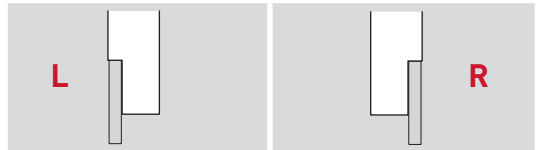
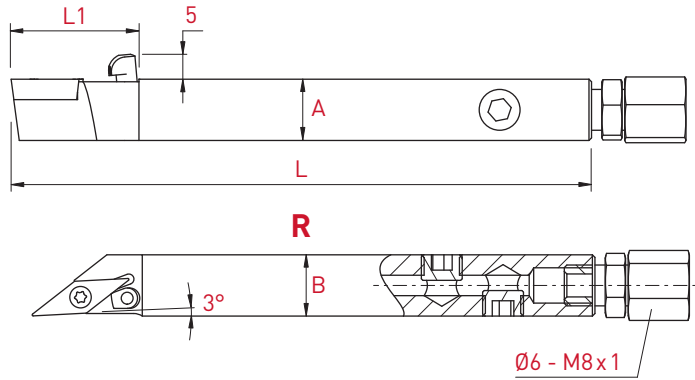

Plaquettes WSP Inserts	A x B	L	L1	Orientation	
				Art. N°	Art. N°
VC...-1103..	10 x 10	110	21	SVJCL-1010J-11-JET	SVJCR-1010J-11-JET
	12 x 12	110	21	SVJCL-1212J-11-JET	SVJCR-1212J-11-JET
	12.7 x 12.7	110	21	SVJCL-12.7J-11-JET	SVJCR-12.7J-11-JET
	16 x 16	110	21	SVJCL-1616J-11-JET	SVJCR-1616J-11-JET
	20 x 20	110	21	SVJCL-2020J-11-JET	SVJCR-2020J-11-JET
VC...-1303..	10 x 10	110	26	SVJCL-1010J-13-JET	SVJCR-1010J-13-JET
	12 x 12	110	26	SVJCL-1212J-13-JET	SVJCR-1212J-13-JET
	12.7 x 12.7	110	26	SVJCL-12.7J-13-JET	SVJCR-12.7J-13-JET
	16 x 16	110	26	SVJCL-1616J-13-JET	SVJCR-1616J-13-JET
	20 x 20	110	26	SVJCL-2020J-13-JET	SVJCR-2020J-13-JET
VC...-1604..	12 x 12	110	30	SVJCL-1212J-16-JET	SVJCR-1212J-16-JET
	12.7 x 12.7	110	30	SVJCL-12.7J-16-JET	SVJCR-12.7J-16-JET
	16 x 16	110	30	SVJCL-1616J-16-JET	SVJCR-1616J-16-JET
	20 x 20	110	30	SVJCL-2020J-16-JET	SVJCR-2020J-16-JET

Porte-outils

Halter

Holders

35°

SVX



SVX

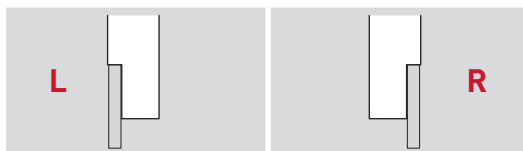
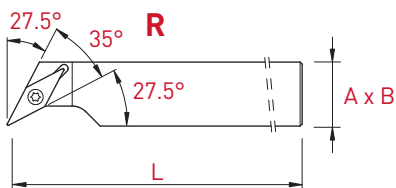

Plaquettes WSP Inserts	A x B	L	Art. N°	Art. N°
VC...-1103..	16 x 16	130	SVXCL-1616X-11	SVXCR-1616X-11
	16 x 16	75	SVXCL-1616F-11	SVXCR-1616F-11
	20 x 20	120	SVXCL-2020X-11	SVXCR-2020X-11

Porte-outils

Halter

Holders

35°

SV-CL/R



SV-CL/R

tournage arrière
rückwärts drehen
back turning

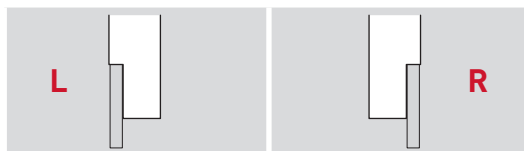
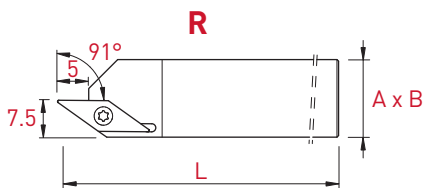

Plaquettes WSP Inserts	A x B	L	Art. N°	Art. N°
VCG...-1103..	12 x 12	130	SV-CL-1212X-11	SV-CR-1212X-11
	12 x 12	90	SV-CL-1212G-11	SV-CR-1212G-11
	12.7 x 12.7	130	SV-CL-12.7X-11	SV-CR-12.7X-11
	16 x 16	130	SV-CL-1616X-11	SV-CR-1616X-11
	16 x 16	75	SV-CL-1616F-11	SV-CR-1616F-11
	20 x 20	120	SV-CL-2020X-11	SV-CR-2020X-11

ISO-LINE

Porte-outils compatibles avec plaquettes VCGT ELP/ERP-FL/FR-X10°

Passende Halter zu den Wendplatten VCGT ELP/ERP-FL/FR-X10°

Holder compatible with inserts VCGT ELP/ERP-FL/FR-X10°

35°

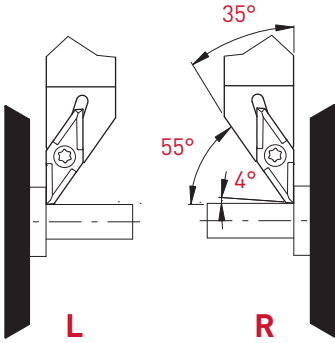

	Art. N°
R	SVACR-...-11
L	SVACL-...-11

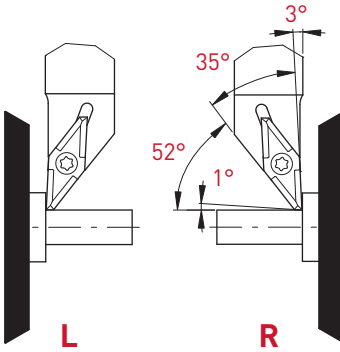

	Art. N°
R	SVJCR-...-11
L	SVJCL-...-11

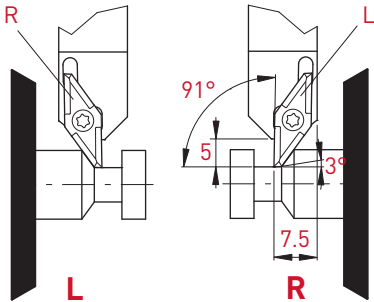

	Art. N°
R	SV-CR-...-11
L	SV-CL-...-11

Porte-outils intérieurs

Innenhalter

Internal holders

35°

A-SVUCR/L

new

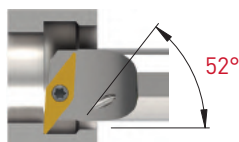

SVU

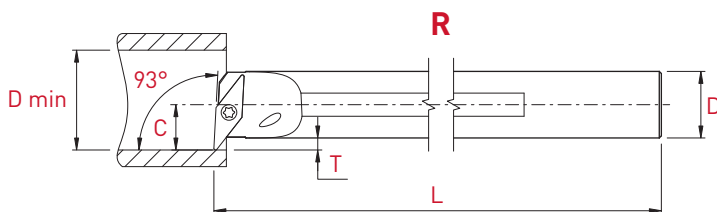
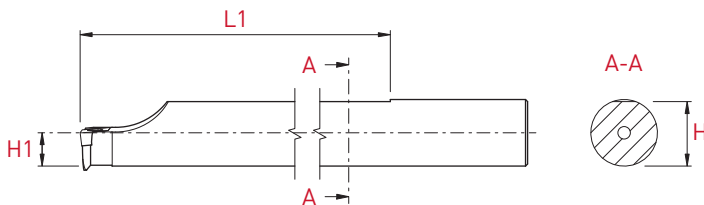

Acier / Stahl / Steel

L

R

Plaquettes WSP Inserts	D	Dmin	T	C	H1	L	L1	H	Art. N°	Art. N°
VC..-1103	16	21	3.1	11	8	150	118	15.5	A16M-SVUCL-11	A16M-SVUCR-11

Pièces de rechange
Ersatzteile
Spare parts



Art. N°

V-M2.5X5.8-T8



Art. N°

C-T8

Plaquettes en métal dur
VHM-Wendepplatten
Solid carbide inserts

35°

VCGT-L/R-X10



**VCGT
FL / FR-X10**

R		Art. N°	PVD					non revêtu unbeschichtet uncoated	
			TiAlN	HTA	TiAlX	HTAX	TiN	K10	K20
0.03		VCGT-1103003-FL-X10	■	■			■	■	■
0.08		VCGT-1103008-FL-X10	■	■			■	■	■
0.1		VCGT-110301-FL-X10	■	■			■	■	■
0.2		VCGT-110302-FL-X10	■	■			■	■	■
0.03		VCGT-1103003-FR-X10	■	■	■	■	■	■	■
0.08		VCGT-1103008-FR-X10	■	■	■	■	■	■	■
0.1		VCGT-110301-FR-X10	■	■	■	■	■	■	■
0.2		VCGT-110302-FR-X10	■	■	■	■	■	■	■

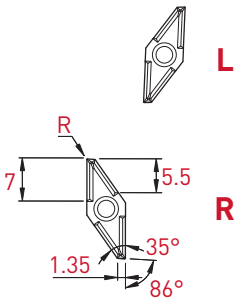

**VCGT
ELP/ERP-X10**

R		Art. N°	PVD					non revêtu unbeschichtet uncoated	
			TiAlN	HTA	TiAlX	HTAX	TiN	K10	K20
0.03		VCGT-1103003-ELP-X10	■	■			■	■	■
0.08		VCGT-1103008-ELP-X10	■	■			■	■	■
0.1		VCGT-110301-ELP-X10	■	■			■	■	■
0.2		VCGT-110302-ELP-X10	■	■			■	■	■
0.03		VCGT-1103003-ERP-X10	■	■	■	■	■	■	■
0.08		VCGT-1103008-ERP-X10	■	■	■	■	■	■	■
0.1		VCGT-110301-ERP-X10	■	■	■	■	■	■	■
0.2		VCGT-110302-ERP-X10	■	■	■	■	■	■	■

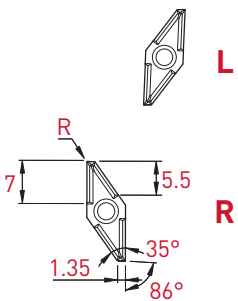

Plaquettes en métal dur

VHM-Wendeplatten

Solid carbide inserts

35°

VCGT-K18

VCGW-0



VCGT
FN-K18

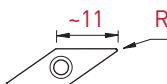

R	Art. N°	PVD		non revêtu unbeschichtet uncoated
		HTA	HTiN	K10
0.05	VCGT-1103005-FN-K18	■	■	■
0.1	VCGT-110301-FN-K18	■	■	■
0.2	VCGT-110302-FN-K18	■	■	■
0.4	VCGT-110304-FN-K18	■	■	■



VCGW
FN-0

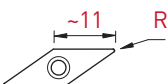

R	Art. N°	PVD		non revêtu unbeschichtet uncoated
		HTA	HTiN	K10
0.05	VCGW-1103005-FN-0	■	■	■
0.1	VCGW-110301-FN-0	■	■	■
0.2	VCGW-110302-FN-0	■	■	■
0.4	VCGW-110304-FN-0	■	■	■



VCGT FN-X8

R	Art. N°	PVD					non revêtu unbeschichtet uncoated	
		TiAlN	HTA	TiAlX	HTAX	TiN	K10	K20
0.05	VCGT-1103005-FN-X8	■	■	■	■	■	■	■
0.08	VCGT-1103008-FN-X8	■	■	■	■	■	■	■
0.1	VCGT-110301-FN-X8	■	■	■	■	■	■	■
0.15	VCGT-1103015-FN-X8	■	■	■	■	■	■	■
0.2	VCGT-110302-FN-X8	■	■	■	■	■	■	■
0.4	VCGT-110304-FN-X8	■	■	■	■	■	■	■
0.05	VCGT-1303005-FN-X8	■	■	■	■	■	■	■
0.1	VCGT-130301-FN-X8	■	■	■	■	■	■	■
0.2	VCGT-130302-FN-X8	■	■	■	■	■	■	■
0.4	VCGT-130304-FN-X8	■	■	■	■	■	■	■
0.05	VCGT-1604005-FN-X8	■	■	■	■	■	■	■
0.1	VCGT-160401-FN-X8	■	■	■	■	■	■	■
0.2	VCGT-160402-FN-X8	■	■	■	■	■	■	■
0.4	VCGT-160404-FN-X8	■	■	■	■	■	■	■

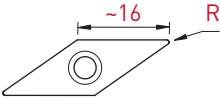
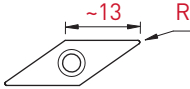
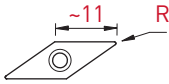

VCGT ENP-X8

R	Art. N°	PVD		non revêtu unbeschichtet uncoated
		TiAlN	TiN	K20
0.05	VCGT-1103005-ENP-X8	■	■	■
0.08	VCGT-1103008-ENP-X8	■	■	■
0.1	VCGT-110301-ENP-X8	■	■	■
0.15	VCGT-1103015-ENP-X8	■	■	■
0.2	VCGT-110302-ENP-X8	■	■	■
0.4	VCGT-110304-ENP-X8	■	■	■
0.05	VCGT-1303005-ENP-X8	■	■	■
0.1	VCGT-130301-ENP-X8	■	■	■
0.2	VCGT-130302-ENP-X8	■	■	■
0.4	VCGT-130304-ENP-X8	■	■	■
0.05	VCGT-1604005-ENP-X8	■	■	■
0.1	VCGT-160401-ENP-X8	■	■	■
0.2	VCGT-160402-ENP-X8	■	■	■
0.4	VCGT-160404-ENP-X8	■	■	■

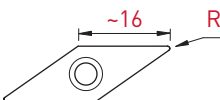
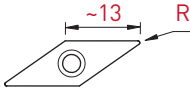
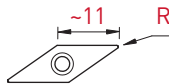

Plaquettes en métal dur

VHM-Wendeplatten

Solid carbide inserts

35°

VCGT-X17

VCGT
FN-X17

R	Art. N°	PVD				non revêtu unbeschichtet uncoated	
		TiAlN	HTA	HTAX	TiN	K10	K20
		P M N S	P M N S	P M S	P M N	<input type="checkbox"/>	<input type="checkbox"/>
				new		<input type="checkbox"/>	<input type="checkbox"/>
0.05	VCGT-1103005-FN-X17	■	■	■	■	■	■
0.08	VCGT-1103008-FN-X17	■	■	■	■	■	■
0.1	VCGT-110301-FN-X17	■	■	■	■	■	■
0.15	VCGT-1103015-FN-X17	■	■	■	■	■	■
0.2	VCGT-110302-FN-X17	■	■	■	■	■	■
0.4	VCGT-110304-FN-X17	■	■	■	■	■	■
0.05	VCGT-1303005-FN-X17	■	■	■	■	■	■
0.1	VCGT-130301-FN-X17	■	■	■	■	■	■
0.2	VCGT-130302-FN-X17	■	■	■	■	■	■
0.4	VCGT-130304-FN-X17	■	■	■	■	■	■
0.05	VCGT-1604005-FN-X17	■	■	■	■	■	■
0.1	VCGT-160401-FN-X17	■	■	■	■	■	■
0.2	VCGT-160402-FN-X17	■	■	■	■	■	■
0.4	VCGT-160404-FN-X17	■	■	■	■	■	■
0.8	VCGT-160408-FN-X17	■	■	■	■	■	■

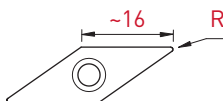
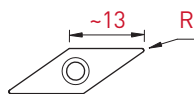
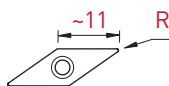
VCGT
ENP-X17

R	Art. N°	PVD		non revêtu unbeschichtet uncoated
		TiAlN	TiN	K20
		P M N S	P M N	<input type="checkbox"/> <input type="checkbox"/> <input checked="" type="checkbox"/> <input type="checkbox"/>
0.05	VCGT-1103005-ENP-X17	■	■	■
0.08	VCGT-1103008-ENP-X17	■	■	■
0.1	VCGT-110301-ENP-X17	■	■	■
0.15	VCGT-1103015-ENP-X17	■	■	■
0.2	VCGT-110302-ENP-X17	■	■	■
0.4	VCGT-110304-ENP-X17	■	■	■
0.05	VCGT-1303005-ENP-X17	■	■	■
0.1	VCGT-130301-ENP-X17	■	■	■
0.2	VCGT-130302-ENP-X17	■	■	■
0.4	VCGT-130304-ENP-X17	■	■	■
0.05	VCGT-1604005-ENP-X17	■	■	■
0.1	VCGT-160401-ENP-X17	■	■	■
0.2	VCGT-160402-ENP-X17	■	■	■
0.4	VCGT-160404-ENP-X17	■	■	■
0.8	VCGT-160408-ENP-X17	■	■	■

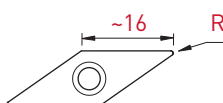
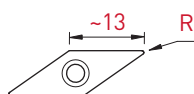
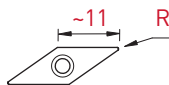

Plaquettes en métal dur

VHM-Wendeplatten

Solid carbide inserts

35°

VCGT-X20



VCGT
ENP-X20

PVD	
<input type="checkbox"/>	<input type="checkbox"/>
<input checked="" type="checkbox"/> M	<input checked="" type="checkbox"/> M
<input checked="" type="checkbox"/> N	<input checked="" type="checkbox"/> N
<input checked="" type="checkbox"/> S	<input checked="" type="checkbox"/> S
ZTA	HTIX

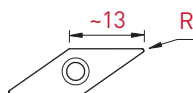

R	H	Art. N°	ZTA	HTIX
0.2	0.25	VCGT-130302-ENP-X20	■	■
0.4	0.25	VCGT-130304-ENP-X20	■	■
0.8	0.25	VCGT-130308-ENP-X20	■	■

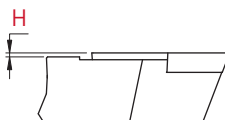

ISO-LINE

Plaquettes en métal dur
 VHM-Wendeplatten
 Solid carbide inserts

35°

VCMT-XF3
 VCMT-XF2



**VCMT
 EN-XF3**

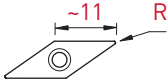

R	Art. N°	PVD	
		TAC	HTAC
0.2	VCMT-110302-EN-XF3	■	■
0.4	VCMT-110304-EN-XF3	■	■

PVD	
P	P
M	M
N	N
S	S
TAC	HTAC



**VCMT
 EN-XF2**

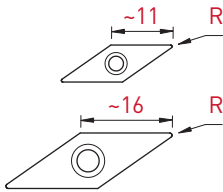

R	Art. N°	PVD		CVD
		TAC	HTAC	HTi5
0.2	VCMT-110302-EN-XF2	■	■	■
0.4	VCMT-110304-EN-XF2	■	■	■
0.4	VCMT-160404-EN-XF2	■	■	■

PVD		CVD
P	P	P
M	M	M
N	N	
S	S	
TAC	HTAC	HTi5

Plaquettes en métal dur

VHM-Wendeplatten

Solid carbide inserts

35°

VCMT-MF

VCMT-HF



VCMT
EN-MF

R	Art. N°	PVD	CVD
		<input checked="" type="checkbox"/> P <input checked="" type="checkbox"/> M <input type="checkbox"/> <input type="checkbox"/> Tmax	<input checked="" type="checkbox"/> P <input checked="" type="checkbox"/> M <input type="checkbox"/> <input type="checkbox"/> Ti4
0.2	VCMT-110302-EN-MF	■	■
0.4	VCMT-110304-EN-MF	■	■
0.4	VCMT-160404-EN-MF	■	■

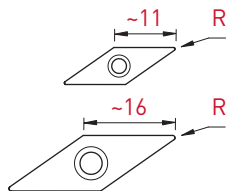

VCMT
EN-HF

R	Art. N°	PVD	CVD
		<input checked="" type="checkbox"/> P <input checked="" type="checkbox"/> M <input type="checkbox"/> <input type="checkbox"/> Tmax	<input checked="" type="checkbox"/> P <input checked="" type="checkbox"/> M <input type="checkbox"/> <input type="checkbox"/> Ti4
0.4	VCMT-110304-EN-HF	■	■
0.8	VCMT-110308-EN-HF	■	■
0.4	VCMT-160404-EN-HF	■	■
0.8	VCMT-160408-EN-HF	■	■

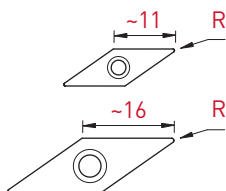



VCGT
 FN-X8



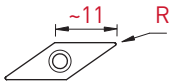

		CERMET	
		PVD	non revêtu unbeschichtet uncoated
		<input checked="" type="checkbox"/> P <input checked="" type="checkbox"/> M <input type="checkbox"/> <input type="checkbox"/>	<input checked="" type="checkbox"/> P <input type="checkbox"/> <input type="checkbox"/> <input type="checkbox"/>
R	Art. N°	CTA	CN6
0.05	VCGT-1103005-FN-X8	<input checked="" type="checkbox"/>	<input checked="" type="checkbox"/>
0.1	VCGT-110301-FN-X8	<input checked="" type="checkbox"/>	<input checked="" type="checkbox"/>
0.2	VCGT-110302-FN-X8	<input checked="" type="checkbox"/>	<input checked="" type="checkbox"/>
0.4	VCGT-110304-FN-X8	<input checked="" type="checkbox"/>	<input checked="" type="checkbox"/>







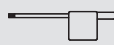

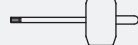
Pièces de rechange et accessoires

Ersatzteile und Zubehör

Spare parts and accessories

Vis et clés de rechange Ersatzschrauben und Schlüssel Spare screws and keys	Porte-outils Halter Holders	Vis Schrauben Screw	Clé Schlüssel Key		
				Option	Serrage Drehmoment Torque
	Series SC...-06 Series SD...-07 Series SV...-11	V-M2.5X7.8-T8 	C-T8 	SET-NM-TX8	1.3 Nm
	Series SV...-13	V-M3X7.3-T8-ISO 			2.0 Nm
	Series SC...-09 Series SD...-11 Series SV...-16	V-M4X9-T15-ISO 	C-T15 	SET-NM-TX15	3.0 Nm

Pièces de rechange JET Ersatzteile JET Spare parts JET	L Pour réf. For ref. Für Ref	 *	 *	 *
		Art. N°	Art. N°	Art. N°
	S...L-10...-JET	JJL-4X12-D1.5		
	S...L-12...-JET S...L-12.7...-JET	JJL-4X14-D1.5	J-M8X1-D6	JB-M8X1
	S...L-16...-JET S...L-20...-JET	JJL-4X17-D1.5		
	R Pour réf. For ref. Für Ref	 *	 *	 *
		Art. N°	Art. N°	Art. N°
	S...R-10...-JET	JJR-4X12-D1.5		
	S...R-12...-JET S...R-12.7...-JET	JJR-4X14-D1.5	J-M8X1-D6	JB-M8X1
	S...R-16...-JET S...R-20...-JET	JJR-4X17-D1.5		

* livré avec chaque porte-outil
mit jedem Halter geliefert
delivered with each holder

Paramètres de coupe indicatifs

Empfohlene Schnittwerte

Standard machining data

ISO-Line	Tough grade, for normal to difficult machining conditions	Wear resistant grade, for finishing and light machining	Acier Stahl Steel						Inox Rostfreistahl Stainless steel			
			Acier de décolletage Automatenstahl Free-cutting steel		Acier faiblement allié Leicht legierter Stahl Low alloyed steel		Acier fortement allié Hochlegierter Stahl High alloyed steel		Austénitique Austenitisch Austenitic		Martensitique Martensitisch Martensitic	
			VC (m/min)	F (mm/U)	VC (m/min)	F (mm/U)	VC (m/min)	F (mm/U)	VC (m/min)	F (mm/U)	VC (m/min)	F (mm/U)
FN-X8	TiAlN	HTA	80-180	0.01-0.12	60-150	0.01-0.10	50-120	0.01-0.08	60-140	0.01-0.12	60-140	0.01-0.12
	TiAlX	HTAX	80-180	0.01-0.12	60-150	0.01-0.10	50-120	0.01-0.08	60-140	0.01-0.12	60-140	0.01-0.12
	TiN		80-170	0.01-0.12	60-140	0.01-0.10			60-120	0.01-0.12	60-120	0.01-0.12
	N	HN										
ENP-X8	TiAlN	HTA	80-180	0.03-0.15	60-160	0.03-0.12	50-120	0.03-0.10	60-140	0.03-0.12	60-140	0.03-0.15
	TiN		80-170	0.03-0.15	60-150	0.03-0.12			60-120	0.03-0.12	60-120	0.03-0.15
	N	HN										
FN-X17	TiAlN	HTA	80-180	0.01-0.12	60-150	0.01-0.10			60-140	0.01-0.15	60-140	0.01-0.15
	TiAlX	HTAX	80-180	0.01-0.12	60-150	0.01-0.10	50-120	0.01-0.08	60-140	0.01-0.12	60-140	0.01-0.12
	TiN		80-170	0.01-0.12					60-120	0.01-0.15	60-120	0.01-0.15
	N	HN										
ENP-X17	TiAlN	HTA	80-180	0.03-0.15	60-160	0.03-0.12	50-120	0.03-0.10	60-140	0.03-0.15	60-140	0.03-0.18
	TiAlX	HTAX	80-180	0.01-0.12	60-150	0.01-0.10	50-120	0.01-0.08	60-140	0.01-0.12	60-140	0.01-0.12
	TiN		80-170	0.03-0.15	60-150	0.03-0.12			60-120	0.01-0.15	60-120	0.03-0.18
	N	HN										
FN-X25	TiAlN	HTA							60-140	0.01-0.12		
	TiN								60-120	0.01-0.12		
	N	HN										
ENP-X25	TiAlN	HTA							60-140	0.03-0.12	60-140	0.03-0.15
	TiAlX		80-180	0.01-0.12	60-150	0.01-0.10	50-120	0.01-0.08	60-140	0.01-0.12	60-140	0.01-0.12
	TiN								60-120	0.03-0.12	60-120	0.03-0.15
	N	HN										
ENP-X20	ZTA								60-140	0.03-0.18	60-140	0.03-0.18
	HTiX								60-140	0.03-0.18	60-140	0.03-0.18

G tolerance class		Special 35° VC...11										
FL / FR-X10	TiAlN	HTA	80-180	0.01-0.12	60-150	0.01-0.10	50-120	0.01-0.08	60-140	0.01-0.12	60-140	0.01-0.12
	TiAlX	HTAX	80-180	0.01-0.12	60-150	0.01-0.10	50-120	0.01-0.08	60-140	0.01-0.12	60-140	0.01-0.12
	TiN		80-170	0.01-0.12	60-140	0.01-0.10			60-120	0.01-0.12	60-120	0.01-0.12
	N	HN										
ELP/ERP-X10	TiAlN	HTA	80-180	0.03-0.15	60-160	0.03-0.12	50-120	0.03-0.10	60-140	0.03-0.12	60-140	0.03-0.15
	TiAlX	HTAX	80-180	0.03-0.15	60-160	0.03-0.12	50-120	0.03-0.10	60-140	0.03-0.12	60-140	0.03-0.15
	TiN		80-170	0.03-0.15	60-150	0.03-0.12			60-120	0.03-0.12	60-120	0.03-0.15
	N	HN										
FN-K18		HTA	80-180	0.01-0.10	60-150	0.01-0.10			60-140	0.01-0.10	60-140	0.01-0.10
		HTiN	80-170	0.01-0.10	60-140	0.01-0.10			60-120	0.01-0.10	60-120	0.01-0.10
		HN										
FN-0		HTA	80-150	0.01-0.10								
		HTiN	80-140	0.01-0.10								
		HN										



N Alliage d'aluminium et non ferreux Aluminium- und Nichteisenlegierungen Aluminium and non-ferrous alloys								S Titane et superalliages Titan und Superlegierungen Titanium and superalloys					
Aluminium		Al-Si		Cuivre Kupfer Copper		Laiton & bronze Messing & Bronze Brass & bronze		Ti grade 1 - 3		Ti grade 4 - 6		Superalliages Superlegierungen Superalloys	
VC (m/min)	F (mm/U)	VC (m/min)	F (mm/U)	VC (m/min)	F (mm/U)	VC (m/min)	F (mm/U)	VC (m/min)	F (mm/U)	VC (m/min)	F (mm/U)	VC (m/min)	F (mm/U)
		150-1600	0.01-0.15	80-300	0.01-0.12	100-400	0.01-0.15			30-60	0.01-0.12	40-70	0.01-0.10
								30-70	0.01-0.12	30-60	0.01-0.12	40-70	0.01-0.10
120-2200	0.01-0.18	150-1600	0.01-0.15	80-300	0.01-0.12	100-400	0.01-0.15						
120-2000	0.01-0.18	150-1500	0.01-0.15	80-250	0.01-0.12	100-300	0.01-0.15	30-70	0.01-0.12				
		150-800	0.03-0.18	80-300	0.03-0.15					30-60	0.03-0.12	40-70	0.03-0.10
		150-800	0.03-0.18	80-300	0.03-0.15								
		150-800	0.03-0.18	80-250	0.03-0.15								
		150-1600	0.01-0.18	80-300	0.01-0.15	100-400	0.01-0.18			30-70	0.01-0.15	40-80	0.01-0.12
								30-70	0.01-0.12	30-60	0.01-0.12	40-70	0.01-0.10
120-2200	0.01-0.25	150-1600	0.01-0.18	80-300	0.01-0.15	100-400	0.01-0.18						
120-2000	0.01-0.25	150-1500	0.01-0.18	80-250	0.01-0.15	100-300	0.01-0.18	40-80	0.01-0.15				
		150-800	0.03-0.20	80-300	0.03-0.18					30-70	0.03-0.15	40-80	0.03-0.12
								30-70	0.01-0.12	30-60	0.01-0.12	40-70	0.01-0.10
		150-800	0.03-0.20	80-300	0.03-0.18								
		150-800	0.03-0.20	80-250	0.03-0.18								
		150-1600	0.01-0.22	80-300	0.01-0.18					30-60	0.01-0.12	40-70	0.01-0.10
120-2200	0.01-0.30	150-1600	0.01-0.22	80-300	0.01-0.18								
120-2000	0.01-0.30	150-1500	0.01-0.22	80-250	0.01-0.18			30-70	0.01-0.12				
		150-800	0.03-0.25	80-300	0.03-0.20					30-60	0.03-0.12	40-70	0.03-0.10
								30-70	0.01-0.12	30-60	0.01-0.12	40-70	0.01-0.10
		150-800	0.03-0.25	80-300	0.03-0.20								
		150-800	0.03-0.25	80-250	0.03-0.20								
		150-800	0.03-0.25	80-300	0.03-0.20					40-90	0.03-0.15	40-100	0.03-0.15
		150-800	0.03-0.25	80-300	0.03-0.20					40-80	0.03-0.15	40-90	0.03-0.15

		150-1600	0.01-0.18	80-300	0.01-0.15	100-400	0.01-0.18			30-60	0.01-0.12	40-70	0.01-0.10
								30-70	0.01-0.12	30-60	0.01-0.12	40-70	0.01-0.10
120-2200	0.01-0.20	150-1600	0.01-0.18	80-300	0.01-0.15	100-400	0.01-0.18						
120-2000	0.01-0.20	150-1500	0.01-0.18	80-250	0.01-0.15	100-300	0.01-0.18	30-70	0.01-0.12				
		150-1600	0.03-0.20	80-300	0.03-0.18					30-60	0.03-0.12	40-70	0.03-0.10
										30-60	0.03-0.12	40-70	0.03-0.10
		150-1600	0.03-0.20	80-300	0.01-0.18								
		150-1500	0.03-0.20	80-250	0.01-0.18								
		150-1600	0.01-0.12	80-300	0.01-0.10					30-70	0.01-0.10	40-80	0.01-0.10
120-2200	0.01-0.15	150-1600	0.01-0.12	80-300	0.01-0.10								
120-2000	0.01-0.15	150-1500	0.01-0.12	80-250	0.01-0.10			40-80	0.01-0.10				
						100-400	0.01-0.18						
						100-400	0.01-0.18						
						100-300	0.01-0.18						

Paramètres de coupe indicatifs

Empfohlene Schnittwerte

Standard machining data

ISO-Line	M tolerance class	Tough grade, for normal to difficult machining conditions	Wear resistant grade, for finishing and light machining	Acier Stahl Steel						Inox Rostfreistahl Stainless steel			
				Acier de décolletage Automatenstahl Free-cutting steel		Acier faiblement allié Leicht legierter Stahl Low alloyed steel		Acier fortement allié Hochlegierter Stahl High alloyed steel		Austénitique Austenitisch Austenitic		Martensitique Martensitisch Martensitic	
				VC (m/min)	F (mm/U)	VC (m/min)	F (mm/U)	VC (m/min)	F (mm/U)	VC (m/min)	F (mm/U)	VC (m/min)	F (mm/U)
EN-XF3	TAC	HTAC		100-200	0.03-0.15	80-160	0.03-0.12	50-120	0.03-0.10	60-140	0.03-0.12	60-140	0.03-0.15
EN-XF2	TAC	HTAC		100-200	0.03-0.15	80-160	0.03-0.12	50-120	0.03-0.10	60-140	0.03-0.12	60-140	0.03-0.15
		HTI5		100-250	0.03-0.15	80-220	0.03-0.12	50-180	0.03-0.10	80-200	0.03-0.12	80-200	0.03-0.15
EN-MF2	TAC	HTAC		100-200	0.04-0.15	80-160	0.04-0.12	50-120	0.04-0.10	60-140	0.04-0.12	60-140	0.04-0.15
		HTI5		100-250	0.04-0.15	80-220	0.04-0.12	50-180	0.04-0.10	80-200	0.04-0.12	80-200	0.04-0.15
EN-MF	Tmax			100-220	0.04-0.30	80-180	0.04-0.25	50-150	0.04-0.20	60-150	0.04-0.25	60-150	0.04-0.25
		Ti4		100-250	0.05-0.30	80-220	0.05-0.25	50-180	0.05-0.20	80-200	0.05-0.25	80-200	0.05-0.25
EN-HF3	TiX	HTiX		100-220	0.06-0.35	80-180	0.06-0.30	50-150	0.06-0.25	60-150	0.06-0.25	60-150	0.06-0.25
		Ti6		100-250	0.06-0.35	80-220	0.06-0.30	50-180	0.06-0.25	80-200	0.06-0.25	80-200	0.06-0.25
EN-HF	Tmax			100-220	0.08-0.40	80-180	0.08-0.35	50-150	0.08-0.30	60-150	0.08-0.30	60-150	0.08-0.30
		TAC		100-200	0.08-0.40	80-160	0.08-0.35	50-140	0.08-0.30	60-140	0.08-0.30	60-140	0.08-0.30
		Ti4		100-250	0.08-0.40	80-220	0.08-0.35	50-180	0.08-0.30	80-200	0.08-0.30	80-200	0.08-0.30
		Ti5	HTi5		100-280	0.08-0.40	80-250	0.08-0.35	50-200	0.08-0.30	80-220	0.08-0.30	80-220

ISO-Line CERMET													
FN-X8 CERMET	CTA			100-350	0.01-0.12	80-300	0.01-0.10	70-250	0.01-0.08	80-250	0.01-0.12	80-250	0.01-0.12
		CN6		100-300	0.01-0.12	80-250	0.01-0.10	70-200	0.01-0.08				
ENP-KX CERMET	CT7	HCT7		100-350	0.03-0.20	80-300	0.03-0.18	70-250	0.03-0.15	80-250	0.03-0.18	80-250	0.03-0.18
		CN6		100-300	0.03-0.20	80-250	0.03-0.18	70-200	0.03-0.15				
EN-KM CERMET	CT7	HCT7		100-350	0.03-0.25	80-300	0.03-0.20	70-250	0.03-0.18	80-250	0.03-0.20	80-250	0.03-0.20
		CN6		100-300	0.03-0.25	80-250	0.03-0.20	70-200	0.03-0.18				



N Alliages d'aluminium et non ferreux Aluminium- und Nichteisenlegierungen Aluminium and non-ferrous alloys								S Titane et superalliages Titan und Superlegierungen Titanium and superalloys					
Aluminium		Al-Si		Cuivre Kupfer Copper		Laiton & bronze Messing & Bronze Brass & bronze		Ti grade 1 - 3		Ti grade 4 - 6		Superalliages Superlegierungen Superalloys	
VC (m/min)	F (mm/U)	VC (m/min)	F (mm/U)	VC (m/min)	F (mm/U)	VC (m/min)	F (mm/U)	VC (m/min)	F (mm/U)	VC (m/min)	F (mm/U)	VC (m/min)	F (mm/U)
		120-1500	0.03-0.20	80-300	0.03-0.15	100-400	0.03-0.18			30-70	0.03-0.15	40-80	0.03-0.12
						100-400	0.03-0.18			30-70	0.03-0.15	40-80	0.03-0.12
		120-1500	0.04-0.20	80-300	0.04-0.15	100-400	0.04-0.18			30-70	0.04-0.15	40-80	0.04-0.12
										30-70	0.06-0.20	40-80	0.06-0.20

Conseils d'utilisation

Anwendungsempfehlungen

Application recommendations

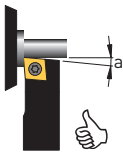

• pour un meilleur état de surface et une meilleure stabilité d'usinage, choisir une géométrie d'outil permettant un angle "a" le plus petit possible

• für bessere Oberflächegüte und Bearbeitungsstabilität, muss die Werkzeuggeometrie mit kleinstmöglichem Winkel "a" ausgewählt werden

• for a better surface finish and better machining stability, choose a tool geometry with angle "a" as small as possible

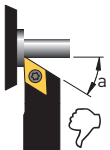

rapport hauteur de passe / rayon d'outil
Verhältnis zwischen Spantiefe und Werkzeugradius
machining depth / tool radius ratio

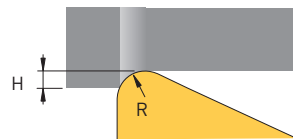

H min = 0.7 X R
R max = 1.4 X H

Porte-outils / Halter / Holders

H

Système de serrage monobloc
Einteiliges Klemmsystem
Monobloc top clamp system

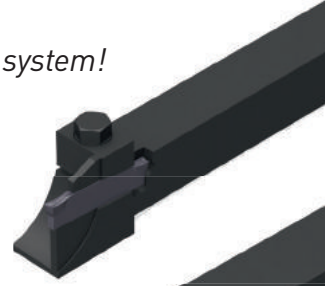

H JET

Porte-outils avec arrosage intégré
Halter mit integrierter Kühlmittelzufuhr
Holders with integrated coolant supply

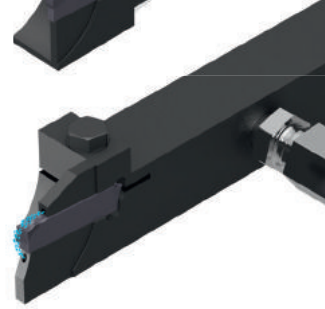

H-HM-JET
GWS-HM
MS-HM

Porte-lames avec arrosage
Halter für Stechklinge mit Kühlung
Holder for parting-off blades with coolant

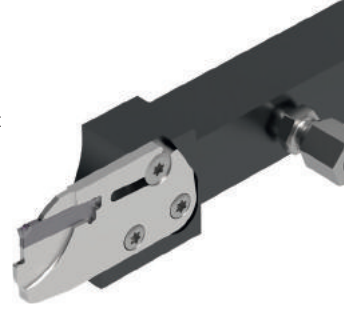

HM
HK
HUK

Lames
Stechklinge
Parting-off blades

Plaquettes / WSP / Inserts

ET 15

=

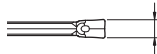

1.5 mm

Ø max 32 mm

ET 20

=

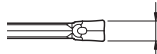

2.0 mm

ET 25

=

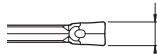

2.5 mm

ET 30

=

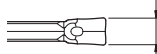

3.0 mm

Ø max 44 mm



U



J



T



A

Very rigid clamping system!

Index

Informations techniques
Technisches Informationen
Technical information > **8.02**

Géométries de coupe
Spanformgeometrie
Cutting geometries > **8.04**

Nuances
Sorten
Grades > **8.05**

H Series sans arrosage
ohne Kühlung
without coolant > **8.06**

H JET Series avec arrosage
mit Kühlung
with coolant > **8.07**

Porte-outils
Halter
Holders **H-HM-JET Series** avec arrosage
mit Kühlung
with coolant > **8.08** **new**

GWS Series Göltenbodt > **8.09** **new**

MS Series Index > **8.13** **new**

Lames
Stecklingen
Blades **HM-HK-HUK Series** > **8.14**

U Series > **8.20**

Plaquettes de tronçonnage
Abstechwendeplatten
Cut off inserts **J Series** > **8.22**

T Series > **8.24**

A Series > **8.26**

Paramètres de coupe indicatifs
Empfohlene Schnittwerte
Standard machining data > **8.28**

Compact: seulement 20 mm
pour les machines courantes

Kompakt: nur 20 mm für
übliche Maschinen

Compact: only 20 mm for
current machines

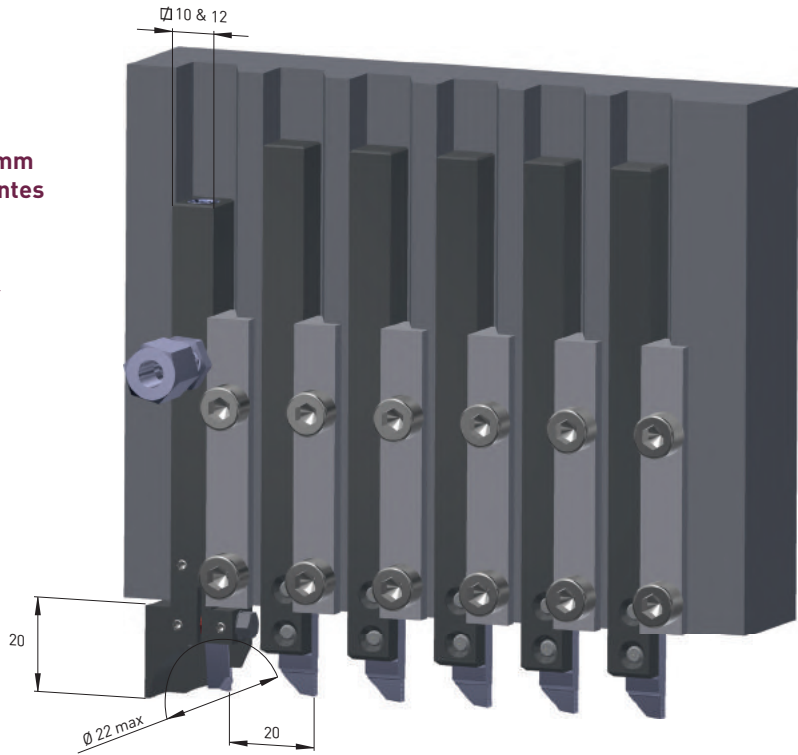

Facilité d'accès

Zugangseichtigkeit

Excellent accessibility

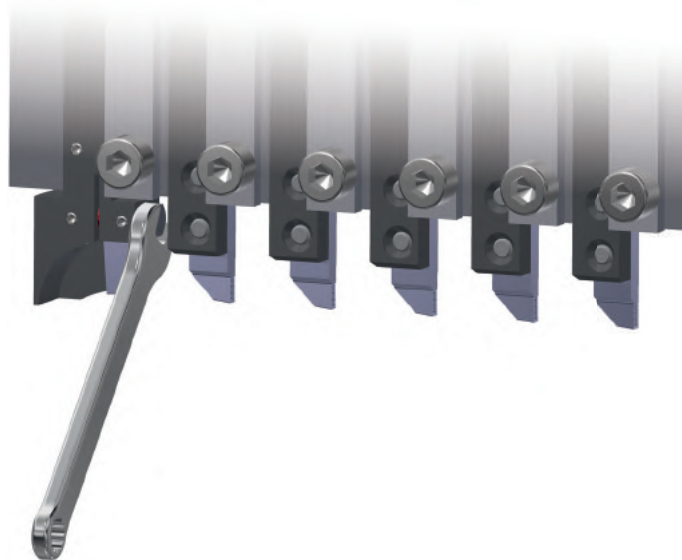

Changement de la plaque
sans démontage

Veränderung der Platte
ohne Zerlegung

Change of insert
without disassembly

Butée de serrage
Spannungs-Anschlag
Clamping stop

Distance de serrage
 Anschlagabstand
 Distance clamping

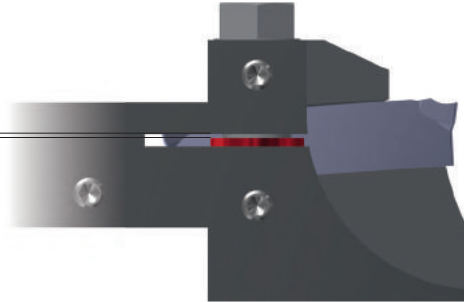

Recommendations de serrage:
 n'utiliser que la clé fournie
Spannungsempfehlungen:
 nur den gelieferten Schlüssel benutzen
Tightening recommendation:
 only use the delivered key

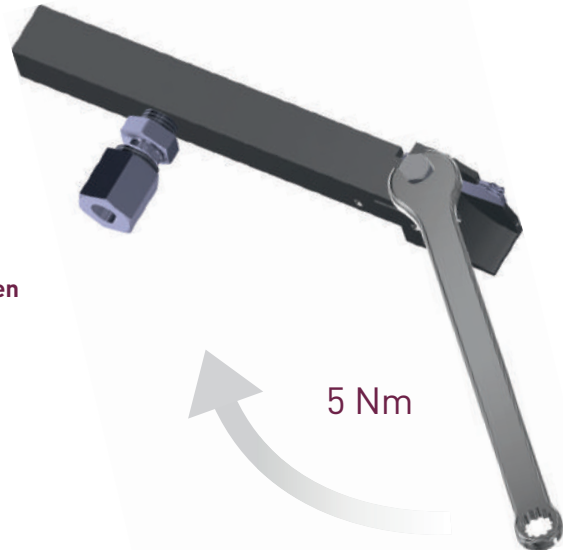

Support JET à double lubrification
JET Halter mit doppeltem Schmierung
Jet holder with double lubrication

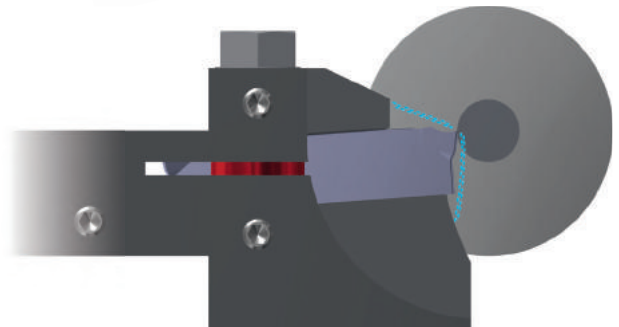

EVOCUT-LINE

Géométries de coupe

Spanformgeometrie

Cutting geometries

UN

UL
UR

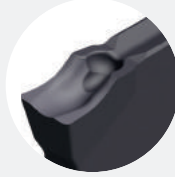

- géométrie positive universelle, faibles efforts de coupe
- bonne maîtrise du copeau
- 1^{er} choix pour l'inox

- allgemeine Geometrie, geringe Schnittkräfte
- gute Spankontrolle
- 1. Wahl für rostfreiem Stahl

- all-round geometry, low cutting forces
- efficient chip control
- 1st choice for stainless steel

JN

JR



- géométrie universelle
- excellent rétrécissement du copeau pour un meilleur contrôle
- conseillé pour le tronçonnage de pièces à parois minces
- pour acier et inox

- allgemeine Geometrie
- ausgezeichnete Spanversmalerung für eine bessere Spankontrolle
- für abstechen von dünnwandigen Teilen empfohlen
- für Stahl und rostfreiem Stahl

- all-round geometry
- very efficient arrow for a better chip control
- recommended for parting off of thin-walled parts
- for steel and stainless steel

TN

TR



- géométrie négative
- utilisation dans des conditions de rigidité optimale
- pour les matières à haute ténacité
- universel pour les aciers et inox

- negative Geometrie
- bei stabilen Verhältnissen einsetzbar
- für hohe widerstandsfähige Rohstoffe
- allgemein für Stahl und rostfreiem Stahl

- negative geometry
- use in solid cutting conditions
- for high toughness material
- universal for steel and stainless steel

AN

AR



- géométrie fortement positive
- roule-copeau poli avec arêtes de coupe vives
- 1^{er} choix pour aluminium et matériaux non ferreux

- stark positive Geometrie
- geschliffene Spanrolle mit scharfe Schneidkanten
- 1. Wahl für Aluminium und Nichteisenmetalle

- very positive geometry
- polished chip roller with sharp cutting edge
- 1st choice for aluminium and non-ferrous materials

Nuances

Sorten

Grades

<p>P M N S</p> <p>TiAlN revêtement PVD PVD Beschichtung PVD coating</p>	<p>P M <input type="checkbox"/> <input type="checkbox"/></p> <p>Tmax revêtement PVD PVD Beschichtung PVD coating</p>	<p>P M <input type="checkbox"/> <input type="checkbox"/></p> <p>Zmax revêtement PVD PVD Beschichtung PVD coating</p>
<ul style="list-style-type: none"> pour l'usinage des aciers, aciers inoxydables et alliages de titane 1^{er} choix pour les avances faibles à modérées 	<ul style="list-style-type: none"> nuance pour usinage moyen à lourd des aciers, aciers alliés et inoxydables bonne résistance aux températures d'usinage élevées 1^{er} choix pour le tronçonnage des aciers au carbone et des aciers fortement alliés 	<ul style="list-style-type: none"> pour l'usinage des aciers, aciers inoxydables et alliages de titane en conditions défavorables bonne résistance aux chocs à des vitesses de coupe moyenne à faible 1^{er} choix pour le tronçonnage en coupe interrompue
<ul style="list-style-type: none"> für die Bearbeitung von Stahl, rostfreiem Stahl und Titanlegierungen beste Wahl für niedrige bis mittlere Vorschübe 	<ul style="list-style-type: none"> Sorte für mittlere bis hohe Belastung in Stahl und legierter Stahlbearbeitung gute Bearbeitungswarmfestigkeit für die Bearbeitung von legiertem Kohlenstahl und hoch legiertem Stahl bestens geeignet 	<ul style="list-style-type: none"> für die Bearbeitung von Stahl, rostfreiem Stahl und Titanlegierungen in schwierige Bearbeitungsfälle gute Bruchfestigkeit mit durchschnittliche bis niedrige Schnittgeschwindigkeit für die Bearbeitung in unterbrochenen Schnitte bestens geeignet
<ul style="list-style-type: none"> for machining of steel, stainless steel and titanium alloys first choice for low to average cutting speed 	<ul style="list-style-type: none"> grade for medium to heavy machining of steel, stainless steel and alloyed steel high machining heat resistance first choice for the machining of carbon steel and high alloyed steel 	<ul style="list-style-type: none"> for machining of steel, stainless steel and titanium alloys in unfavourable machining conditions good impact resistance with average to low cutting speed first choice for machining in interrupted cut
<p>P M <input type="checkbox"/> <input type="checkbox"/></p> <p>ZTi6 revêtement CVD CVD Beschichtung CVD coating</p>	<p><input type="checkbox"/> <input type="checkbox"/> N S</p> <p>AS revêtement PVD PVD Beschichtung PVD coating</p>	<p><input type="checkbox"/> <input type="checkbox"/> N S</p> <p>N non-revêtu unbeschichtet uncoated</p>
<ul style="list-style-type: none"> nuance très tenace grande résistance à la température 1^{er} choix pour les aciers «haute température» secondairement pour les aciers inox 	<ul style="list-style-type: none"> nuance pour métaux non ferreux très faible coefficient de frottement 1^{er} choix pour l'usinage des aluminiums jusqu'à 5% Si, des cuivres et titanes faiblement alliés 	<ul style="list-style-type: none"> nuance non revêtu recommandé pour l'usinage des matières non-ferreuses titane, laiton, cuivre, aluminium sans silicium, plastique
<ul style="list-style-type: none"> sehr zähe Sorte hohe Bearbeitungswarmfestigkeit 1. Wahl für „hohe Temperatur“ Stähle sekundär für rostfreie Stähle 	<ul style="list-style-type: none"> Sorte für Nichteisenmetalle sehr geringer Reibwert für die Bearbeitung von Aluminium bis 5% Si, Kupfer und niedriglegiertem Titan bestens geeignet 	<ul style="list-style-type: none"> unbeschichtete Sorte für die Bearbeitung von Nichteisenmetalle empfohlen Titan, Messing, Kupfer, Silicium freies Aluminium, Kunststoff
<ul style="list-style-type: none"> very strong grade good wear resistance 1st choice for "high temperature" steels secondarily for stainless steels 	<ul style="list-style-type: none"> grade for non-ferrous materials very low friction ratio first choice for aluminium up to 5% Si, copper and low alloyed titanium 	<ul style="list-style-type: none"> uncoated grade recommended for machining of non-ferrous materials titanium, brass, bronze, aluminium without silicium, plastic

EVOCUT-LINE

Porte-outils
Halter
Holders

Ø max 44 mm

H Series

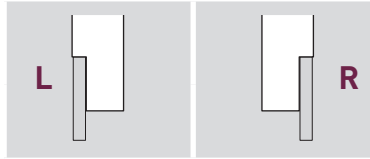
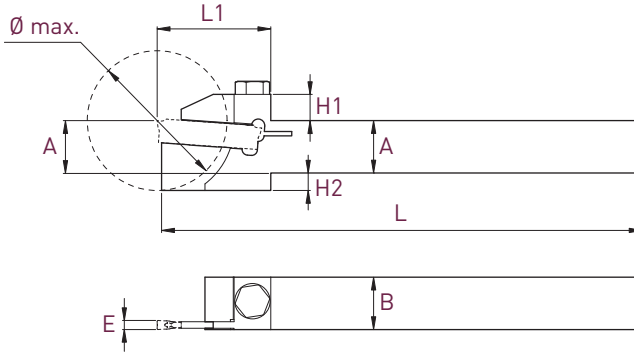

Plaquettes WSP Inserts	A x B	L	Ø max.	L1	H1	H2	Art. N°		Pièces de rechange Ersatzteile Spare parts	
							Art. N°	Art. N°	Art. N°	Art. N°
E 1.5	10x12	110	22	20	5	6	ET15-H1012L-D22	ET15-H1012R-D22	V-M5X20-6P6	C-6PEX-6.0
	12x12	110	22	20	5	4	ET15-H1212L-D22	ET15-H1212R-D22		
	12.7x12.7	110	22	20	5	3	ET15-H12.7L-D22	ET15-H12.7R-D22		
Type ET15	12x12	110	32	26	6	4	ET15-H1212L-D32	ET15-H1212R-D32	V-M5X21-6P7	C-6PEX-7.0
	12.7x12.7	110	32	26	6	3	ET15-H12.7L-D32	ET15-H12.7R-D32		
	16x16	110	32	26	6	-	ET15-H1616L-D32	ET15-H1616R-D32		
E 2.0	10x12	110	22	20	5	6	ET20-H1012L-D22	ET20-H1012R-D22	V-M5X20-6P6	C-6PEX-6.0
	12x12	110	22	20	5	4	ET20-H1212L-D22	ET20-H1212R-D22		
	12.7x12.7	110	22	20	5	3	ET20-H12.7L-D22	ET20-H12.7R-D22		
Type ET20	12x12	110	32	26	6	4	ET20-H1212L-D32	ET20-H1212R-D32	V-M5X21-6P7	C-6PEX-7.0
	12.7x12.7	110	32	26	6	3	ET20-H12.7L-D32	ET20-H12.7R-D32		
	16x16	110	32	26	6	-	ET20-H1616L-D32	ET20-H1616R-D32		
E 2.5	10x12	110	22	20	5	6	ET25-H1012L-D22	ET25-H1012R-D22	V-M5X20-6P6	C-6PEX-6.0
	12x12	110	22	20	5	4	ET25-H1212L-D22	ET25-H1212R-D22		
	12.7x12.7	110	22	20	5	3	ET25-H12.7L-D22	ET25-H12.7R-D22		
Type ET25	12x12	110	32	26	6	4	ET25-H1212L-D32	ET25-H1212R-D32	V-M5X21-6P7	C-6PEX-7.0
	12.7x12.7	110	32	26	6	3	ET25-H12.7L-D32	ET25-H12.7R-D32		
	16x16	110	32	26	6	-	ET25-H1616L-D32	ET25-H1616R-D32		
E 3.0	16x16	130	44	35	8	4	ET30-H1616L-D44	ET30-H1616R-D44	V-M5X27-6P7	C-6PEX-7.0
	20x20	130	44	35	8	-	ET30-H2020L-D44	ET30-H2020R-D44		
	25x25	140	44	35	8	-	ET30-H2525L-D44	ET30-H2525R-D44		
Type ET30	16x16	130	44	35	8	4	ET30-H1616L-D44	ET30-H1616R-D44	V-M5X27-6P7	C-6PEX-7.0
	20x20	130	44	35	8	-	ET30-H2020L-D44	ET30-H2020R-D44		
	25x25	140	44	35	8	-	ET30-H2525L-D44	ET30-H2525R-D44		

* livré avec chaque porte-outil
mit jedem Halter geliefert
delivered with each holder

Porte-outils avec arrosage intégré

Halter mit integrierter Kühlmittelzufuhr

Holder with integrated coolant supply

Ø max 44 mm

H JET Series

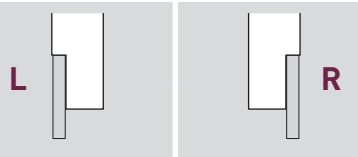
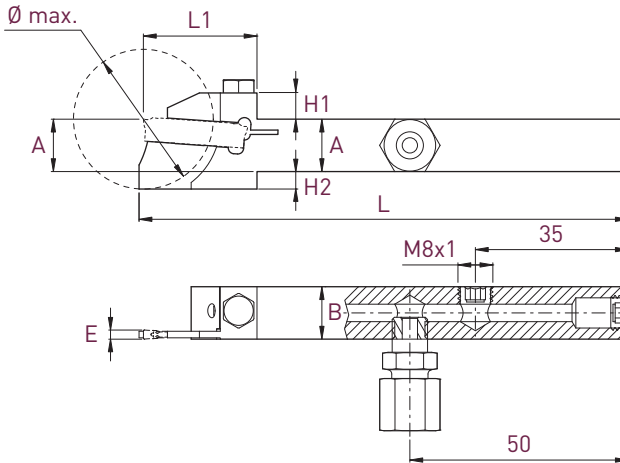

Pièces de rechange
Ersatzteile
Spare parts



Plaquettes WSP Inserts	A x B	L	Ø max.	L1	H1	H2	Art. N°	
							L	R
E 2.0 Type ET20	10x12	110	22	20	5	6	ET20-H1012L-JET22	ET20-H1012R-JET22
	12x12	110	22	20	5	4	ET20-H1212L-JET22	ET20-H1212R-JET22
	12.7x12.7	110	22	20	5	3	ET20-H12.7L-JET22	ET20-H12.7R-JET22
	12x12	110	32	26	6	4	ET20-H1212L-JET32	ET20-H1212R-JET32
	12.7x12.7	110	32	26	6	3	ET20-H12.7L-JET32	ET20-H12.7R-JET32
	16x16	110	32	26	6	-	ET20-H1616L-JET32	ET20-H1616R-JET32
	16x16	130	44	35	8	4	ET20-H1616L-JET44	ET20-H1616R-JET44
20x20	130	44	35	8	-	ET20-H2020L-JET44	ET20-H2020R-JET44	
E 2.5 Type ET25	10x12	110	22	20	5	6	ET25-H1012L-JET22	ET25-H1012R-JET22
	12x12	110	22	20	5	4	ET25-H1212L-JET22	ET25-H1212R-JET22
	12.7x12.7	110	22	20	5	3	ET25-H12.7L-JET22	ET25-H12.7R-JET22
	12x12	110	32	26	6	4	ET25-H1212L-JET32	ET25-H1212R-JET32
	12.7x12.7	110	32	26	6	3	ET25-H12.7L-JET32	ET25-H12.7R-JET32
	16x16	110	32	26	6	-	ET25-H1616L-JET32	ET25-H1616R-JET32
	16x16	130	44	35	8	4	ET25-H1616L-JET44	ET25-H1616R-JET44
20x20	130	44	35	8	-	ET25-H2020L-JET44	ET25-H2020R-JET44	
E 3.0 Type ET30	16x16	110	32	26	6	-	ET30-H1616L-JET32	ET30-H1616R-JET32
	16x16	130	44	35	8	4	ET30-H1616L-JET44	ET30-H1616R-JET44
	20x20	130	44	35	8	-	ET30-H2020L-JET44	ET30-H2020R-JET44
	25x25	140	44	35	8	-	ET30-H2525L-JET44	ET30-H2525R-JET44

Art. N°	Art. N°
V-M5X20-6P6-J	C-6PEX-6.0
V-M5X21-6P7-J	C-6PEX-7.0
V-M5X27-6P7-J	C-6PEX-7.0
V-M5X20-6P6-J	C-6PEX-6.0
V-M5X21-6P7-J	C-6PEX-7.0
V-M5X27-6P7-J	C-6PEX-7.0
V-M5X21-6P7-J	C-6PEX-7.0
V-M5X27-6P7-J	C-6PEX-7.0

Pièces de rechange
Ersatzteile
Spare parts



Art. N°

Art. N°

J-M8X1-D6

JB-M8X1

* Livré avec chaque porte-outil
mit jedem Halter geliefert
delivered with each holder

EVOCUT-LINE

Porte-lames avec arrosage

Halter für Stechklinge mit Kühlung

Holder for parting-off blades with coolant

H-HM-JET Series

new

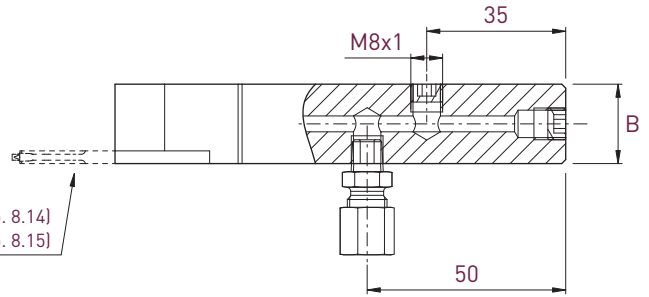
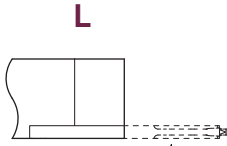
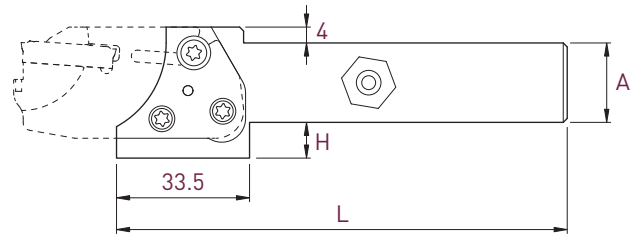

HM-IN (p. 8.14)
HM-IL-JET (p. 8.15)

HM-IN (p. 8.14)
HM-IR-JET (p. 8.15)





A x B	L	H	Art. N°	Art. N°
16x16	113.5	13	H1616L-HM-JET	H1616R-HM-JET
20x20	113.5	9	H2020L-HM-JET	H2020R-HM-JET
25x25	138.5	4	H2525L-HM-JET	H2525R-HM-JET

Pièces de rechange Ersatzteile Spare parts					
	Art. N°	Art. N°	Art. N°	Art. N°	Art. N°
	V-M5X10-T20IP	V-M6X10-T20IP	J-M8X1-D6	JB-M8X1	C-T20IP

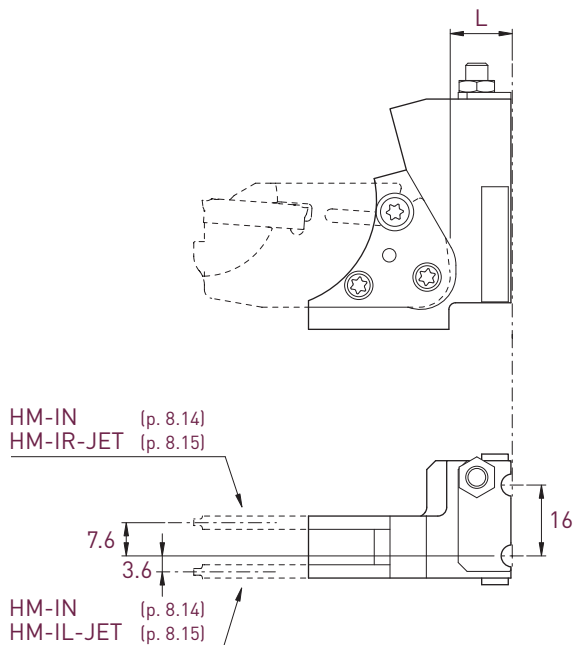
new

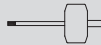

Pièces de rechange
Ersatzteile
Spare parts

Interface	Machine compatibility	L	Art. N°	Pièces de rechange Ersatzteile Spare parts		
				Art. N°	Art. N°	Art. N°
GWS02	AS14	14	GWS02R-02001-HM-JET			
	SAS16					
	SBS20					
	Others	22	GWS02R-02002-HM-JET			

new

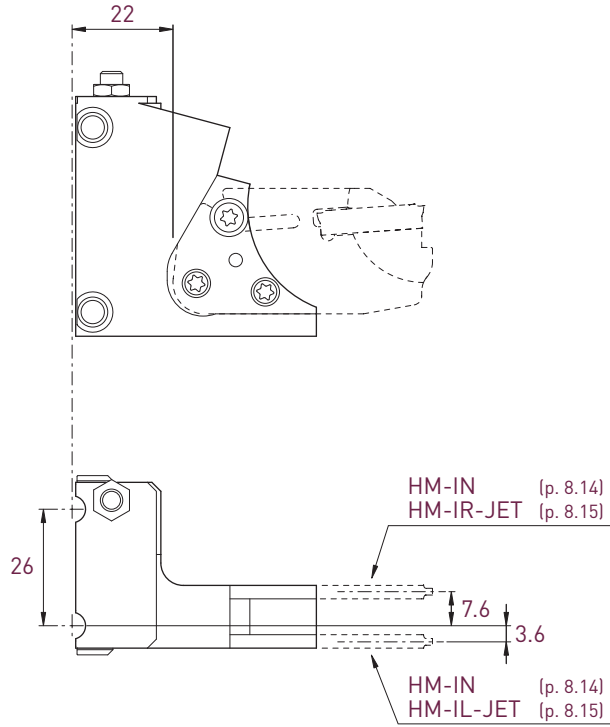

Pièces de rechange
Ersatzteile
Spare parts

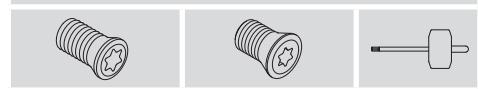

Interface	Machine compatibility	Art. N°	Art. N°	Art. N°	Art. N°
GWS41	MultiSwiss 6X16	GWS41L-41001-HM-JET	V-M5X10-T20IP	V-M6X10-T20IP	C-T20IP
	MultiDeco 20X6				
	MultiDeco 20X8				
	MultiDeco 26X6				
	MultiDeco 32X6				
	MultiAlpha 20X8				
	MultiSigma 24X8				

new

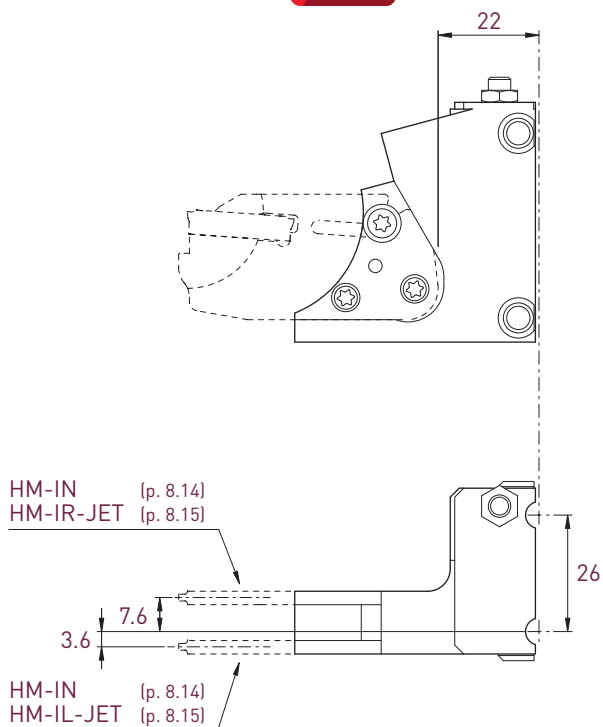



Pièces de rechange
Ersatzteile
Spare parts

Interface	Machine compatibility	Art. N°	Pièces de rechange Ersatzteile Spare parts		
			Art. N°	Art. N°	Art. N°
GWS41	MultiSwiss 6X16	GWS41R-41001-HM-JET	V-M5X10-T20IP	V-M6X10-T20IP	C-T20IP
	MultiDeco 20X6				
	MultiDeco 20X8				
	MultiDeco 26X6				
	MultiDeco 32X6				
	MultiAlpha 20X8				
	MultiSigma 24X8				

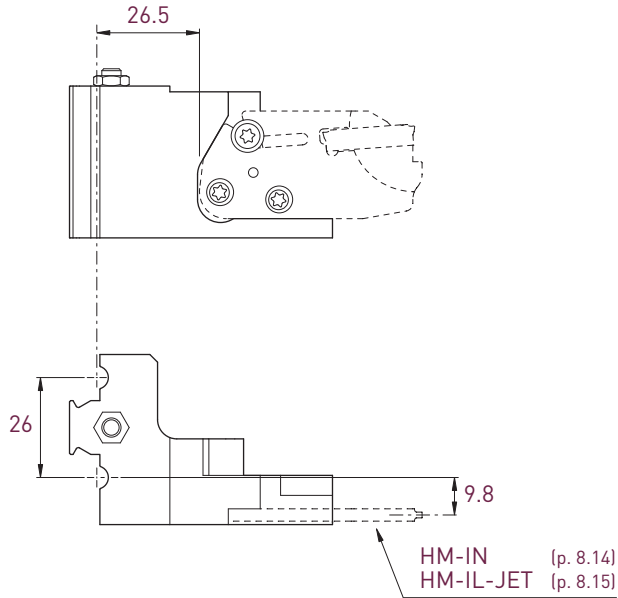
new

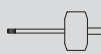

		Pièces de rechange Ersatzteile Spare parts			
Interface	Machine compatibility	Art. N°	 Art. N°	 Art. N°	 Art. N°
GWS202	MultiSwiss 6X32	GWS202L-202001-HM-JET	V-M5X10-T20IP	V-M6X10-T20IP	C-T20IP
	MultiSwiss 8X26				

new

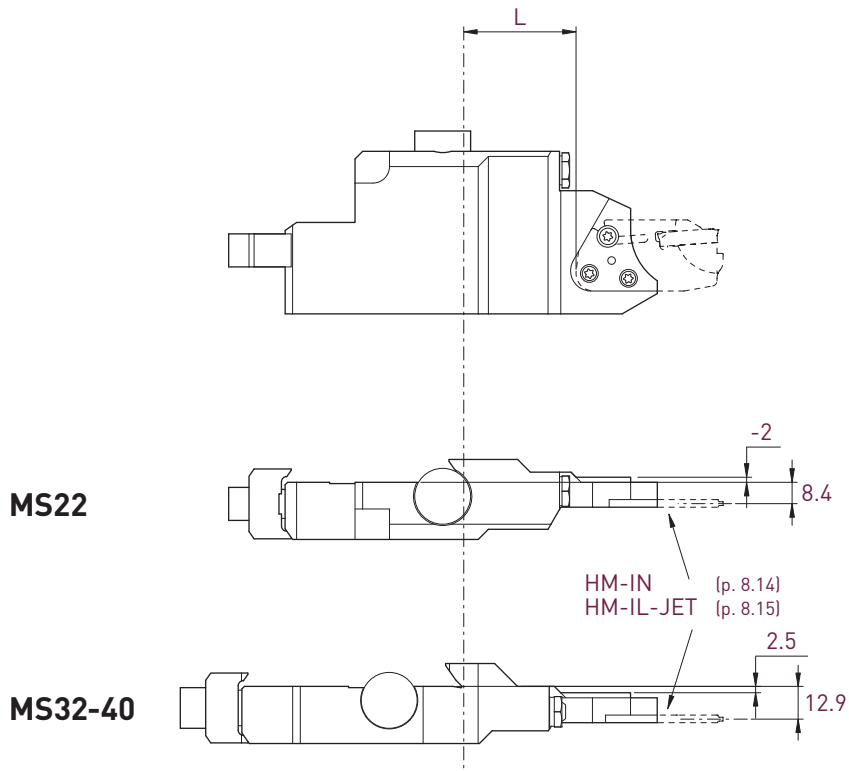

Pièces de rechange
Ersatzteile
Spare parts

Machine compatibility	L	Art. N°	Pièces de rechange Ersatzteile Spare parts		
			Art. N°	Art. N°	Art. N°
MS22	44.2	MS22-W5190231-HM-JET	V-M5X10-T20IP	V-M6X10-T20IP	C-T20IP
MS32-40	45.5	MS32-40-W5190233-HM-JET			

EVO CUT-LINE

Lames pour système modulaire
 Stechklinge für modulares System
 Parting-off blades for modular system

HM Series

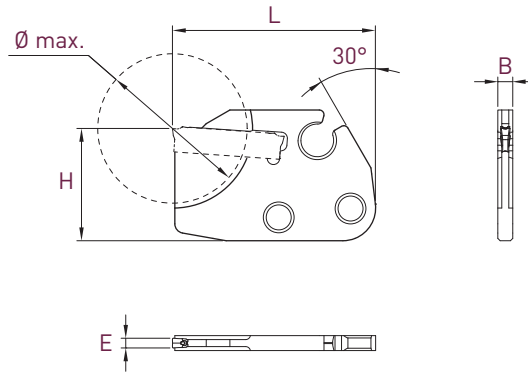

N

Plaquettes WSP Inserts	Ø max.	B	L	H	Art. N°
E 1.5 Type ET15	20	3.2	43.5	24	ET15-HM-IN-43-D20
	32	3.2	43.5	24	ET15-HM-IN-43-D32
E 2.0 Type ET20	20	3.2	43.5	24	ET20-HM-IN-43-D20
	26	3.2	43.5	24	ET20-HM-IN-43-D26
	26	3.2	54	24	ET20-HM-IN-54-D26
	32	3.2	43.5	24	ET20-HM-IN-43-D32
E 3.0 Type ET30	32	3.2	43.5	24	ET30-HM-IN-43-D32

Lames avec arrosage intégré

Steckklinge mit integrierter Kühlmittelzufuhr

Parting-off blades with integrated coolant supply

HM-JET Series

new

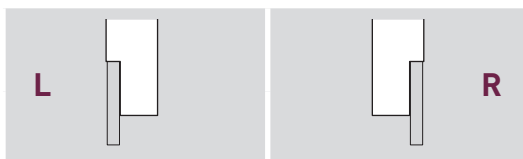
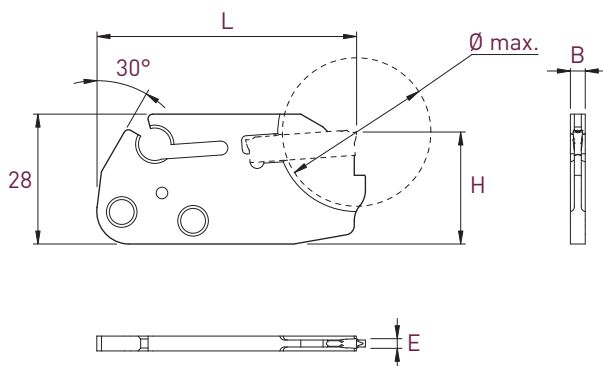

Plaquettes WSP Inserts	Ø max.	B	L	H	Art. N°	Art. N°
E 2.0 Type ET20	20	3.2	48.5	24	ET20-HM-IL-48.5-JET20	ET20-HM-IR-48.5-JET20
	24		48.5		ET20-HM-IL-48.5-JET24	ET20-HM-IR-48.5-JET24
	32		45.5		ET20-HM-IL-45.5-JET32	ET20-HM-IR-45.5-JET32
	32		56		ET20-HM-IL-56-JET32	ET20-HM-IR-56-JET32
	42		48.5		ET20-HM-IL-48.5-JET42	ET20-HM-IR-48.5-JET42
E 3.0 Type ET30	32	3.2	45.5	24	ET30-HM-IL-45.5-JET32	ET30-HM-IR-45.5-JET32
	44		48.5		ET30-HM-IL-48.5-JET42	ET30-HM-IR-48.5-JET42

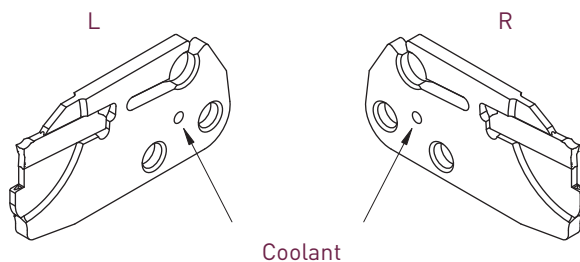

EVOCUT-LINE

Lames de tronçonnage



Stechklinge

Parting-off blades

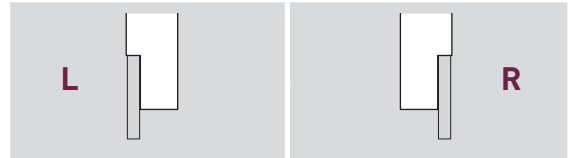
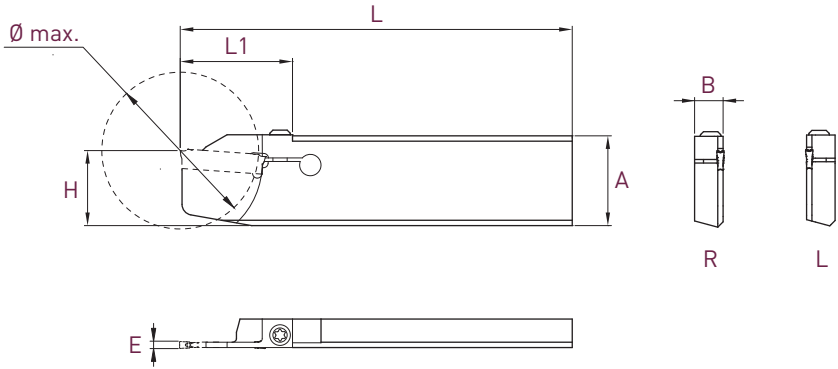
HK Series



Plaquettes WSP Inserts	A x B	L	Ø max.	L1	H	Art. N°	Art. N°
E 1.5 Type ET15	26x8	110	20	19.5	21	ET15-HK-2608L-110-D20	ET15-HK-2608R-110-D20
	26x8	110	32	25.5	21	ET15-HK-2608L-110-D32	ET15-HK-2608R-110-D32
E 2.0 Type ET20	26x8	110	32	25.5	21	ET20-HK-2608L-110-D32	ET20-HK-2608R-110-D32
	26x8	110	44	31.5	21	ET20-HK-2608L-110-D44	ET20-HK-2608R-110-D44

Pièces de rechange Ersatzteile Spare parts	 *	 *
	Art. N°	Art. N°
	V-M4X14.5-T15-EVOCUT	C-T15

* livré avec chaque lame
mit jedem Stechkling geliefert
delivered with each blade

Lames de tronçonnage avec dégagement pour accès contre-broche

Stecklinge mit Aussparung für Gegenspindel Zugriff

Parting-off blades with recess for subspindle access

HK-RS Series

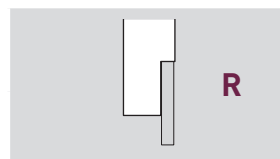
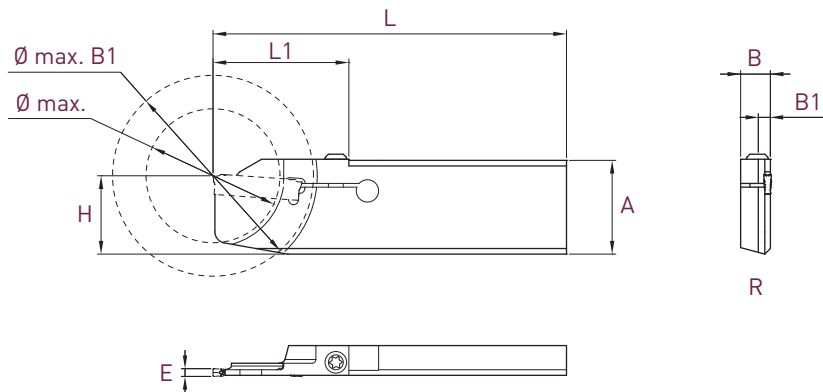

Plaquettes WSP Inserts	A x B	L	Ø max.	Ø max. B1	B1	L1	H	Art. N°
E 1.5 Type ET15	26x8	95	36	54	3.25	36.5	21	ET15-HK-2608RS-95-D36
E 2.0 Type ET20	26x8	95	36	54	3.25	36.5	21	ET20-HK-2608RS-95-D36

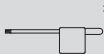
Pièces de rechange Ersatzteile Spare parts	 *	 *
	Art. N°	Art. N°
	V-M4X14.5-T15-EVOCUT	C-T15

* livré avec chaque lame
mit jedem Steckling geliefert
delivered with each blade

EVOCUT-LINE

Lames de tronçonnage inversées
 Überkopf Stechklinge
 Upside down parting-off blades

HUK Series

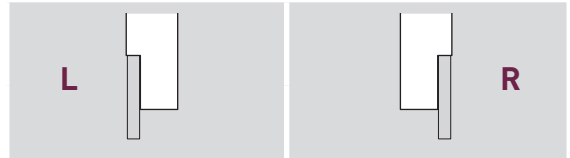
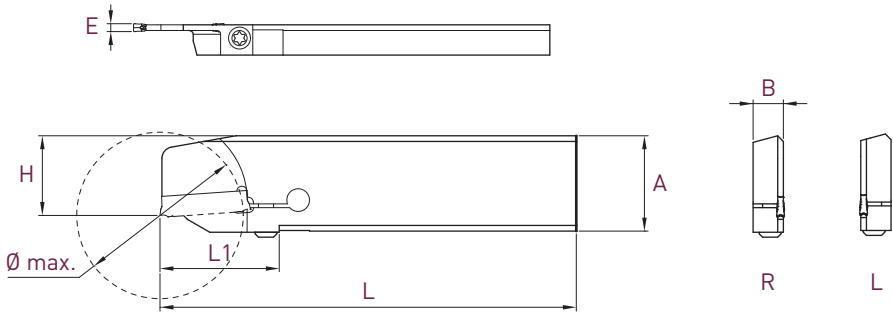

Plaquettes WSP Inserts	A x B	L	Ø max.	L1	H	Art. N°	Art. N°
E 1.5 Type ET15	26x8	110	20	19.5	21	ET15-HUK-2608L-110-D20	ET15-HUK-2608R-110-D20
	26x8	110	32	25.5	21	ET15-HUK-2608L-110-D32	ET15-HUK-2608R-110-D32
E 2.0 Type ET20	26x8	110	32	25.5	21	ET20-HUK-2608L-110-D32	ET20-HUK-2608R-110-D32
	26x8	110	44	31.5	21	ET20-HUK-2608L-110-D44	ET20-HUK-2608R-110-D44

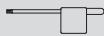
Pièces de rechange Ersatzteile Spare parts	 *	 *
	Art. N°	Art. N°
	V-M4X14.5-T15-EVOCUT	C-T15

* livré avec chaque lame
 mit jedem Steckling geliefert
 delivered with each blade

SWITCH-LINE



NEW

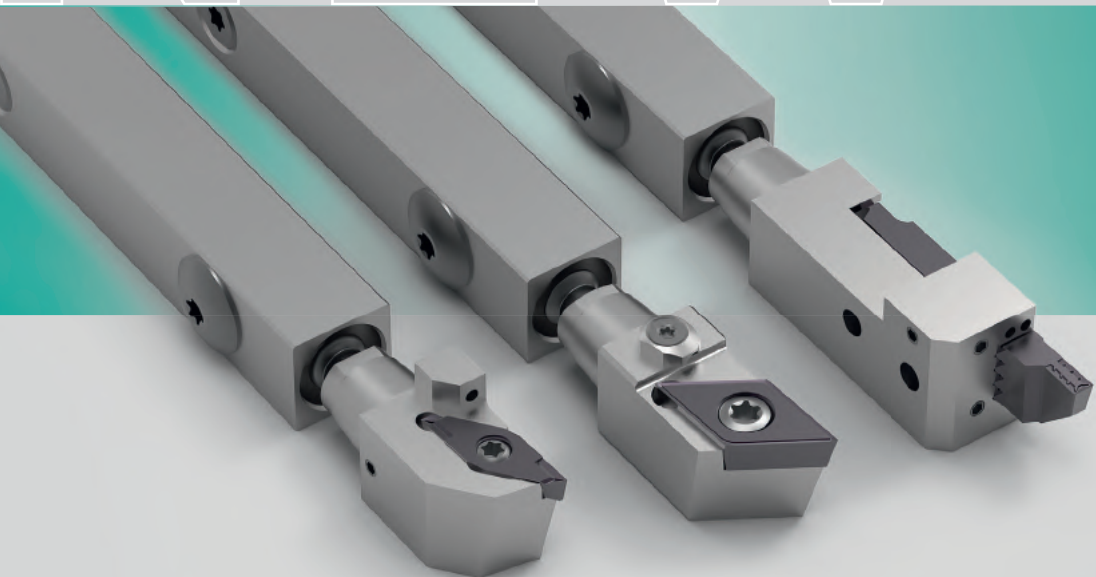



DISCOVER THE RANGE SWITCH-LINE IN CHAPTER 11!

EVOCUT-LINE

Plaquettes de tronçonnage
 Abstechwendeplatten
 Cut off inserts

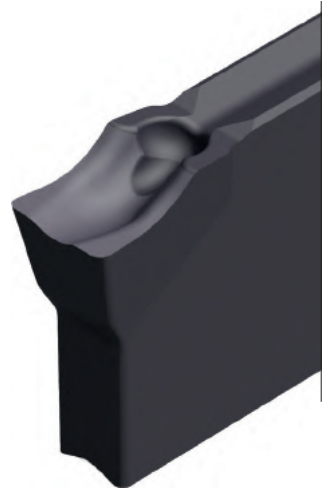
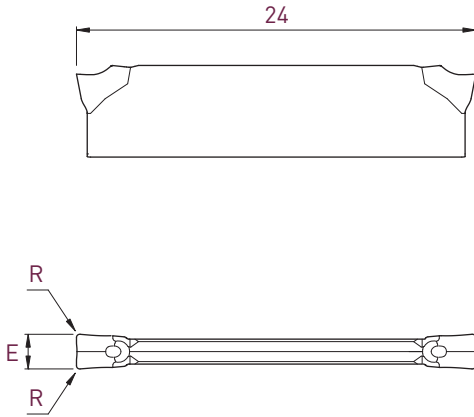
UN Series



			UN 				
Type	$E_{\pm 0.05}$	R	Art. N°	T:AIN 	Tmax 	Zmax 	ZTi6
ET15	1.35	0	ET15-UN-000F	■			
	1.5	0.2	ET15-UN-002	■	■	■	
ET20	1.85	0	ET20-UN-000F	■			
	2.0	0.2	ET20-UN-002	■	■	■	■
ET25	2.35	0	ET25-UN-000F	■			
	2.5	0.3	ET25-UN-003	■	■	■	■
ET30	2.85	0	ET30-UN-000F	■			
	3.0	0.3	ET30-UN-003	■	■	■	■

Plaquettes de tronçonnage

Abstechwendeplatten

Cut off inserts

UL-UR Series

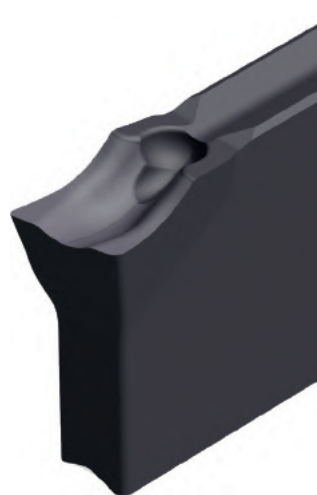
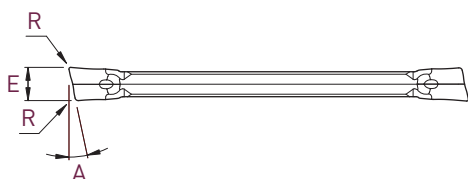
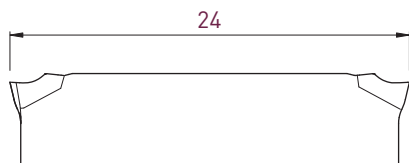

Type	E ±0.05	A	R	UL			UR				
				Art. N°	TiAIN	Tmax	Zmax	Art. N°	TiAIN	Tmax	Zmax
ET15	1.5	6°	0.2	-	<input type="checkbox"/>	<input type="checkbox"/>	<input type="checkbox"/>	ET15-UR-602	<input type="checkbox"/>	<input type="checkbox"/>	<input type="checkbox"/>
	1.35	8°	0	-	<input type="checkbox"/>	<input type="checkbox"/>	<input type="checkbox"/>	ET15-UR-800F	<input type="checkbox"/>	<input type="checkbox"/>	<input type="checkbox"/>
	1.5	12°	0.1	-	<input type="checkbox"/>	<input type="checkbox"/>	<input type="checkbox"/>	ET15-UR-1201	<input type="checkbox"/>	<input type="checkbox"/>	<input type="checkbox"/>
	1.35	15°	0	ET15-UL-1500F	<input checked="" type="checkbox"/>	<input type="checkbox"/>	<input type="checkbox"/>	ET15-UR-1500F	<input checked="" type="checkbox"/>	<input type="checkbox"/>	<input type="checkbox"/>
ET20	2.0	6°	0.2	-	<input type="checkbox"/>	<input type="checkbox"/>	<input type="checkbox"/>	ET20-UR-602	<input type="checkbox"/>	<input type="checkbox"/>	<input type="checkbox"/>
	1.85	8°	0	-	<input type="checkbox"/>	<input type="checkbox"/>	<input type="checkbox"/>	ET20-UR-800F	<input type="checkbox"/>	<input type="checkbox"/>	<input type="checkbox"/>
	2.0	12°	0.1	-	<input type="checkbox"/>	<input type="checkbox"/>	<input type="checkbox"/>	ET20-UR-1201	<input type="checkbox"/>	<input type="checkbox"/>	<input type="checkbox"/>
	1.85	15°	0	ET20-UL-1500F	<input checked="" type="checkbox"/>	<input type="checkbox"/>	<input type="checkbox"/>	ET20-UR-1500F	<input checked="" type="checkbox"/>	<input type="checkbox"/>	<input type="checkbox"/>
ET25	2.5	6°	0.2	-	<input type="checkbox"/>	<input type="checkbox"/>	<input type="checkbox"/>	ET25-UR-602	<input type="checkbox"/>	<input type="checkbox"/>	<input type="checkbox"/>
	2.35	8°	0	-	<input type="checkbox"/>	<input type="checkbox"/>	<input type="checkbox"/>	ET25-UR-800F	<input type="checkbox"/>	<input type="checkbox"/>	<input type="checkbox"/>
	2.5	12°	0.1	-	<input type="checkbox"/>	<input type="checkbox"/>	<input type="checkbox"/>	ET25-UR-1201	<input type="checkbox"/>	<input type="checkbox"/>	<input type="checkbox"/>
	2.35	15°	0	ET25-UL-1500F	<input checked="" type="checkbox"/>	<input type="checkbox"/>	<input type="checkbox"/>	ET25-UR-1500F	<input checked="" type="checkbox"/>	<input type="checkbox"/>	<input type="checkbox"/>
ET30	3.0	6°	0.3	-	<input type="checkbox"/>	<input type="checkbox"/>	<input type="checkbox"/>	ET30-UR-603	<input type="checkbox"/>	<input type="checkbox"/>	<input type="checkbox"/>
	2.85	8°	0	-	<input type="checkbox"/>	<input type="checkbox"/>	<input type="checkbox"/>	ET30-UR-800F	<input type="checkbox"/>	<input type="checkbox"/>	<input type="checkbox"/>
	3.0	12°	0.2	-	<input type="checkbox"/>	<input type="checkbox"/>	<input type="checkbox"/>	ET30-UR-1202	<input type="checkbox"/>	<input type="checkbox"/>	<input type="checkbox"/>
	2.85	15°	0	ET30-UL-1500F	<input checked="" type="checkbox"/>	<input type="checkbox"/>	<input type="checkbox"/>	ET30-UR-1500F	<input checked="" type="checkbox"/>	<input type="checkbox"/>	<input type="checkbox"/>

EVOCUT-LINE

Plaquettes de tronçonnage
 Abstechwendeplatten
 Cut off inserts

JN Series

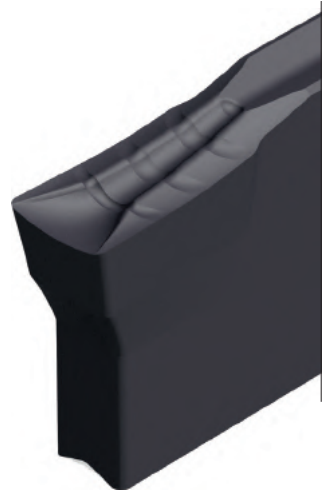
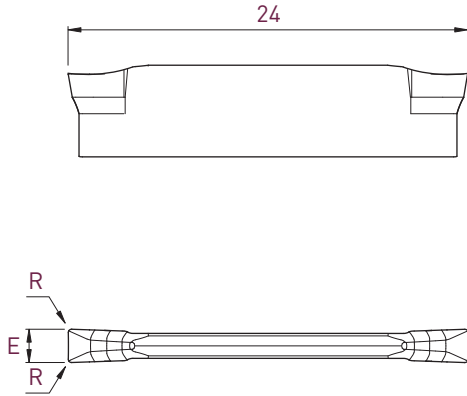

			JN				
Type	E ±0.05	R	Art. N°	TiAlN	Tmax	Zmax	ZTi6
ET15	1.5	0.2	ET15-JN-002	■	■	■	■
ET20	2.0	0.2	ET20-JN-002	■	■	■	■
ET25	2.5	0.3	ET25-JN-003	■	■	■	■
ET30	3.0	0.3	ET30-JN-003	■	■	■	■

Plaquettes de tronçonnage

Abstechwendeplatten

Cut off inserts

JR Series

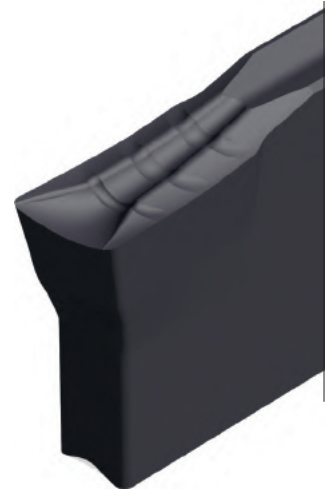
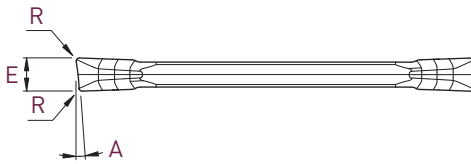
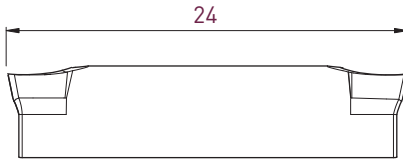

				JR			
Type	E ± 0.05	A	R	Art. N°	TiAlN	Tmax	Zmax
ET15	1.5	6°	0.2	ET15-JR-602	■	■	■
ET20	2.0	6°	0.2	ET20-JR-602	■	■	■
ET25	2.5	6°	0.2	ET25-JR-602	■	■	■
ET30	3.0	6°	0.3	ET30-JR-603	■	■	■

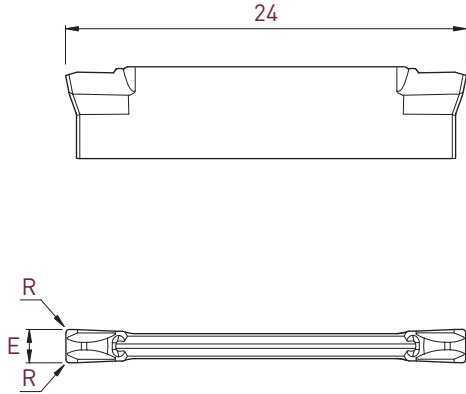

			TN 				
Type	E ±0.05	R	Art. N°	TiAlN <input type="checkbox"/>	Tmax <input type="checkbox"/>	Zmax <input type="checkbox"/>	ZTi6 <input type="checkbox"/>
ET20	2.0	0.2	ET20-TN-002	<input checked="" type="checkbox"/>	<input checked="" type="checkbox"/>	<input checked="" type="checkbox"/>	<input checked="" type="checkbox"/>
ET25	2.5	0.3	ET25-TN-003	<input checked="" type="checkbox"/>	<input checked="" type="checkbox"/>	<input checked="" type="checkbox"/>	<input checked="" type="checkbox"/>
ET30	3.0	0.3	ET30-TN-003	<input checked="" type="checkbox"/>	<input checked="" type="checkbox"/>	<input checked="" type="checkbox"/>	<input checked="" type="checkbox"/>

Plaquettes de tronçonnage

Abstechwendeplatten

Cut off inserts

Negative geometry

TR Series

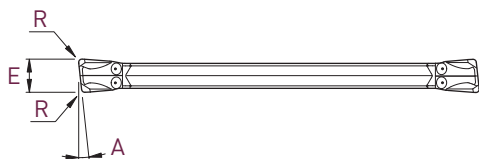
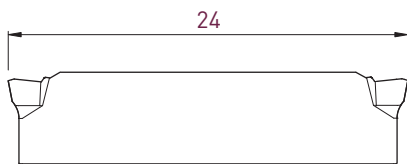

				TR																	
Type	E ±0.05	A	R	Art. N°	<table border="1"> <tr> <td><input type="checkbox"/></td><td><input type="checkbox"/></td><td><input type="checkbox"/></td><td><input type="checkbox"/></td> </tr> <tr> <td><input type="checkbox"/></td><td><input type="checkbox"/></td><td><input type="checkbox"/></td><td><input type="checkbox"/></td> </tr> <tr> <td><input type="checkbox"/></td><td><input type="checkbox"/></td><td><input type="checkbox"/></td><td><input type="checkbox"/></td> </tr> <tr> <td><input type="checkbox"/></td><td><input type="checkbox"/></td><td><input type="checkbox"/></td><td><input type="checkbox"/></td> </tr> </table>	<input type="checkbox"/>	<input type="checkbox"/>	<input type="checkbox"/>	<input type="checkbox"/>	<input type="checkbox"/>	<input type="checkbox"/>	<input type="checkbox"/>	<input type="checkbox"/>	<input type="checkbox"/>	<input type="checkbox"/>	<input type="checkbox"/>	<input type="checkbox"/>	<input type="checkbox"/>	<input type="checkbox"/>	<input type="checkbox"/>	<input type="checkbox"/>
<input type="checkbox"/>	<input type="checkbox"/>	<input type="checkbox"/>	<input type="checkbox"/>																		
<input type="checkbox"/>	<input type="checkbox"/>	<input type="checkbox"/>	<input type="checkbox"/>																		
<input type="checkbox"/>	<input type="checkbox"/>	<input type="checkbox"/>	<input type="checkbox"/>																		
<input type="checkbox"/>	<input type="checkbox"/>	<input type="checkbox"/>	<input type="checkbox"/>																		
ET20	2.0	6°	0.2	ET20-TR-602	■ ■ ■																
ET25	2.5	6°	0.2	ET25-TR-602	■ ■ ■																
ET30	3.0	6°	0.3	ET30-TR-603	■ ■ ■ ■																

EVOCUT-LINE

Plaquettes de tronçonnage
 Abstechwendeplatten
 Cut off inserts

AN Series

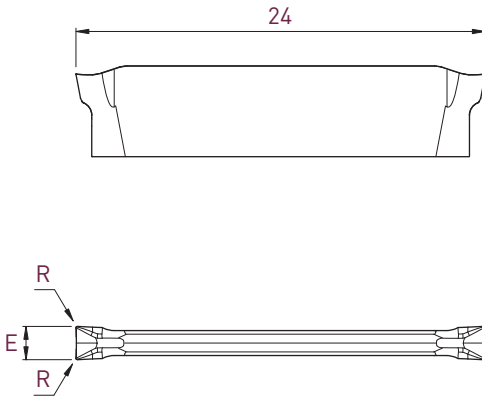

				AN		
Type	E ±0.05	R	Art. N°	T	A	N
ET20	2.0	0.2	ET20-AN-002F	■	■	■
ET30	3.0	0.3	ET30-AN-003F	■	■	■



Plaquettes de tronçonnage

Abstechwendeplatten

Cut off inserts

AR Series

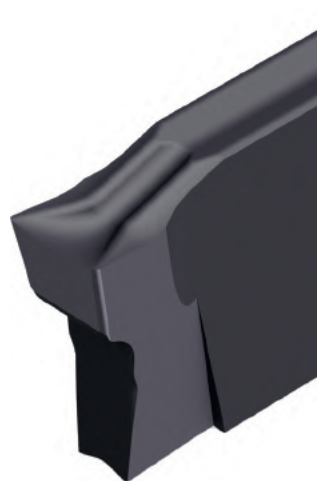
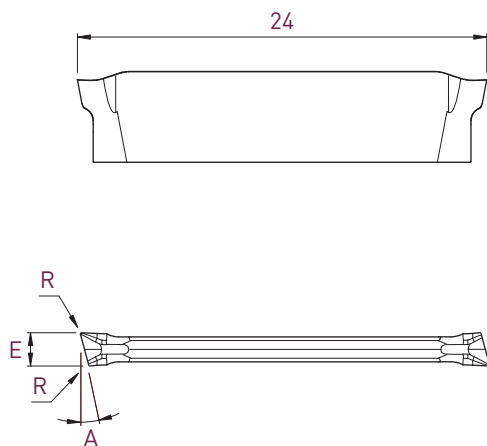









				AR			
Type	E ± 0.05	A	R	Art. N°	TiAIN	AS	N
ET20	2.0	15°	0.1	ET20-AR-1501F	■	■	■
ET30	3.0	15°	0.2	ET30-AR-1502F	■	■	■

EVOCUT-LINE

Paramètres de coupe indicatifs

Empfohlene Schnittwerte

Standard machining data

						P Acier Stahl Steel						M Inox Rostfreistahl Stainless steel		
						Acier de décolletage Automatenstahl Free-cutting steel		Acier faiblement allié Leicht legierter Stahl Low alloyed steel		Acier fortement allié Legierter Stahl High alloyed steel		Austenitique et martensitique Austenitic and martensitic		
		ET15	ET20	ET25	ET30	VC (m/min)	F (mm/U)	VC (m/min)	F (mm/U)	VC (m/min)	F (mm/U)	VC (m/min)	F (mm/U)	
Avance standard Standard Vorschub Standard feed rate	UN 	TiAlN	■	■	■	■	90-140	0.04-0.08	60-120	0.04-0.08	50-100	0.04-0.08	50-120	0.04-0.08
		Tmax	■	■	■	■	100-170	0.04-0.08	70-150	0.04-0.08	60-120	0.04-0.08	60-150	0.04-0.08
		Zmax	■	■	■	■	80-130*	0.04-0.10	50-110*	0.04-0.10	50-90*	0.04-0.10	50-120*	0.04-0.10
		ZTi6	■	■	■	■	110-200	0.04-0.08	80-160	0.04-0.08	70-140	0.04-0.08	70-160	0.04-0.08
	UR 	TiAlN	■	■	■	■	90-140	0.04-0.08	60-120	0.04-0.08	50-100	0.04-0.08	50-120	0.04-0.08
		Tmax	■	■	■	■	100-170	0.04-0.08	70-150	0.04-0.08	60-120	0.04-0.08	60-150	0.04-0.08
		Zmax	■	■	■	■	80-130*	0.04-0.10	50-110*	0.04-0.10	50-90*	0.04-0.10	50-120*	0.04-0.10
		ZTi6	■	■	■	■	110-200	0.04-0.08	80-160	0.04-0.08	70-140	0.04-0.08	70-160	0.04-0.08
	JN 	TiAlN	■	■	■	■	90-140	0.04-0.08	60-120	0.04-0.08	50-100	0.04-0.08	50-120	0.04-0.08
		Tmax	■	■	■	■	100-170	0.04-0.08	70-150	0.04-0.08	60-120	0.04-0.08	60-150	0.04-0.08
		Zmax	■	■	■	■	80-130*	0.04-0.10	50-110*	0.04-0.10	50-90*	0.04-0.10	50-120*	0.04-0.10
		ZTi6	■	■	■	■	110-200	0.04-0.08	80-160	0.04-0.08	70-140	0.04-0.08	70-160	0.04-0.08
	JR 	TiAlN	■	■	■	■	90-140	0.04-0.08	60-120	0.04-0.08	50-100	0.04-0.08	50-120	0.04-0.08
		Tmax	■	■	■	■	100-170	0.04-0.08	70-150	0.04-0.08	60-120	0.04-0.08	60-150	0.04-0.08
		Zmax	■	■	■	■	80-130*	0.04-0.10	50-110*	0.04-0.10	50-90*	0.04-0.10	50-120*	0.04-0.10
		ZTi6	■	■	■	■	110-200	0.04-0.08	80-160	0.04-0.08	70-140	0.04-0.08	70-160	0.04-0.08
	TN 	TiAlN	■	■	■	■	90-150	0.08-0.18	70-130	0.08-0.18	50-100	0.08-0.15	50-120	0.08-0.20
		Tmax	■	■	■	■	100-170	0.08-0.18	70-150	0.08-0.18	60-120	0.08-0.15	60-150	0.08-0.20
		Zmax	■	■	■	■	80-130*	0.08-0.18	50-110*	0.08-0.18	50-90*	0.08-0.15	50-120*	0.08-0.20
		ZTi6	■	■	■	■	110-200	0.08-0.18	80-160	0.08-0.18	70-140	0.08-0.15	70-160	0.08-0.20
	TR 	TiAlN	■	■	■	■	90-150	0.08-0.18	70-130	0.08-0.18	50-100	0.08-0.15	50-120	0.08-0.20
		Tmax	■	■	■	■	100-170	0.08-0.18	70-150	0.08-0.18	60-120	0.08-0.15	60-150	0.08-0.20
		Zmax	■	■	■	■	80-130*	0.08-0.18	50-110*	0.08-0.18	50-90*	0.08-0.15	50-120*	0.08-0.20
		ZTi6	■	■	■	■	110-200	0.08-0.18	80-160	0.08-0.18	70-140	0.08-0.15	70-160	0.08-0.20
Avance modérée Niedriger Vorschub Low feed rate	UN-000F 	TiAlN	■	■	■	■	80-120	0.02-0.05	50-100	0.02-0.05	40-80	0.02-0.05	40-100	0.02-0.05
		UR/ULF	TiAlN	■	■	■	■	80-120	0.02-0.05	50-100	0.02-0.05	40-80	0.02-0.05	40-100
	ANF 	N	■	■	■	■								
		TiAlN	■	■	■	■							40-80	0.02-0.05
	ARF 	N	■	■	■	■								
		TiAlN	■	■	■	■							40-80	0.02-0.05
		AS	■	■	■	■								

* premier choix en cas de coupe interrompue

** arête de coupe vive

* beste Basis für unterbrochene Schnitte

** scharfe Schneidkante

* first choice for interrupted cut

** sharp cutting edge

N Alliage d'aluminium et non ferreux Aluminium- und Nichteisenlegierungen Aluminium and non-ferrous alloys								S Titane Titan Titanium			
Aluminium		Alu silicium max. 5% Aluminiumsilicium max. 5% Aluminium silicon max. 5%		Cuivre Kupfer Copper		Laiton & bronze Messing & Bronze Brass & bronze		Gr. 1 - 3		Gr. 4 - 5	
VC (m/min)	F (mm/U)	VC (m/min)	F (mm/U)	VC (m/min)	F (mm/U)	VC (m/min)	F (mm/U)	VC (m/min)	F (mm/U)	VC (m/min)	F (mm/U)
100-250	0.03-0.10	100-250	0.03-0.10	100-300	0.03-0.10	100-300	0.03-0.10			50-100	0.04-0.08
100-250	0.03-0.10	100-250	0.03-0.10	100-300	0.03-0.10	100-300	0.03-0.10			50-100	0.04-0.08
100-250	0.03-0.10	100-250	0.03-0.10	100-300	0.03-0.10	100-300	0.03-0.10			50-100	0.04-0.08
100-250	0.03-0.10	100-250	0.03-0.10	100-300	0.03-0.10	100-300	0.03-0.10			50-100	0.04-0.08
100-300	0.02-0.06	100-200	0.01-0.05	100-250	0.01-0.05	100-300	0.02-0.06			50-100	0.01-0.06
100-300	0.02-0.06	100-200	0.01-0.05	100-250	0.01-0.05	100-300	0.02-0.06			50-100	0.01-0.06
80-200	0.02-0.06			80-200	0.01-0.05	80-200	0.02-0.06	50-100	0.01-0.06	50-100	0.01-0.06
100-250	0.02-0.06	80-150	0.01-0.05	100-200	0.01-0.05	80-200	0.02-0.06			30-80	0.01-0.06
100-300	0.02-0.06	100-200	0.01-0.05	100-250	0.01-0.05	100-300	0.02-0.06	50-120	0.01-0.06	50-120	0.01-0.06
80-200	0.02-0.06			80-200	0.01-0.05	80-200	0.02-0.06	50-100	0.01-0.06	50-100	0.01-0.06
100-250	0.02-0.06	80-150	0.01-0.05	100-200	0.01-0.05	80-200	0.02-0.06			30-80	0.01-0.06
100-300	0.02-0.06	100-200	0.01-0.05	100-250	0.01-0.05	100-300	0.02-0.06	50-120	0.01-0.06	50-120	0.01-0.06



CUT-LINE

APPLITEC

Porte-outils / Halter / Holders

H Système de serrage à bride, version courte
Spannbrücke Klemmsystem, kurze Ausführung
Independent top clamp system, short version

HX Système de serrage à bride, version longue
Spannbrücke Klemmsystem, lange Ausführung
Independent top clamp system, long version

HZ Porte-outils de grande capacité
Klemmhalter für grössere Durchmesser
High capacity tool holders

Very rigid clamping system!

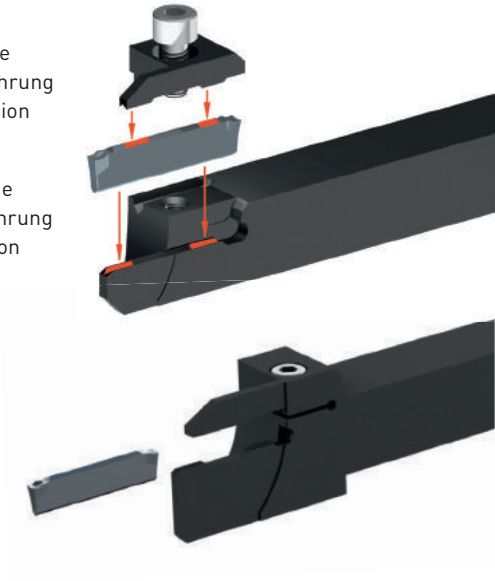

Plaquettes / WSP / Inserts

CUT 16 =  1.6 mm Ø max 20 mm

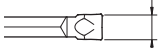
CUT 22 =  2.2 mm Ø max 42 mm

CUT 31 =  3.1 mm Ø max 65 mm



U



P



T



G

Nuances et géométries
Sorten und Geometrien
Grades and types of geometries > **9.02**

CUT 16 Ø max 20 mm > **9.04**

Paramètres de coupe indicatifs
Empfohlene Schnittwerte
Standard machining data > **9.06**

CUT 31 Ø max 65 mm > **9.08**

H Series > **9.10**

Porte-outils
Halter
Holders > **9.11**

HZ Series > **9.12**

Porte-outils avec arrosage intégré
Halter mit integrierter Kühlmittelzufuhr
Holders with integrated coolant supply > **9.13**

U Series > **9.14**

Plaquettes de tronçonnage
Abstechwendeplatten
Cut off inserts > **9.16**

T Series > **9.20**

Plaquettes de fonçage, tournage et tronçonnage
WSP zum einstecken, drehen und abstechen
Inserts for grooving, turning and cut off > **9.21**

<h3>TiAlN</h3> <p>revêtement PVD PVD Beschichtung PVD coating</p>	<h3>Tmax</h3> <p>revêtement PVD PVD Beschichtung PVD coating</p>	<h3>Zmax</h3> <p>revêtement PVD PVD Beschichtung PVD coating</p>
<ul style="list-style-type: none"> pour l'usinage des aciers, aciers inoxydables et alliages de titane 1^{er} choix pour les avances faibles à modérées 	<ul style="list-style-type: none"> nuance pour usinage moyen à lourd des aciers, aciers alliés et inoxydables bonne résistance aux températures d'usinage élevées 1^{er} choix pour le tronçonnage des aciers au carbone et des aciers fortement alliés 	<ul style="list-style-type: none"> pour l'usinage des aciers, aciers inoxydables et alliages de titane en conditions défavorables bonne résistance aux chocs à des vitesses de coupe moyenne à faible 1^{er} choix pour le tronçonnage en coupe interrompue
<ul style="list-style-type: none"> für die Bearbeitung von Stahl, rostfreiem Stahl und Titanlegierungen beste Wahl für niedrige bis mittlere Vorschübe 	<ul style="list-style-type: none"> Sorte für mittlere bis hohe Belastung in Stahl und legierter Stahlbearbeitung gute Bearbeitungswarmfestigkeit für die Bearbeitung von legiertem Kohlenstahl und hoch legiertem Stahl bestens geeignet 	<ul style="list-style-type: none"> für die Bearbeitung von Stahl, rostfreiem Stahl und Titanlegierungen in schwierige Bearbeitungsfälle gute Bruchfestigkeit mit durchschnittliche bis niedrige Schnittgeschwindigkeit für die Bearbeitung in unterbrochenen Schnitte bestens geeignet
<ul style="list-style-type: none"> for machining of steel, stainless steel and titanium alloys first choice for low to average cutting speed 	<ul style="list-style-type: none"> grade for medium to heavy machining of steel, stainless steel and alloyed steel high machining heat resistance first choice for the machining of carbon steel and high alloyed steel 	<ul style="list-style-type: none"> for machining of steel, stainless steel and titanium alloys in unfavourable machining conditions good impact resistance with average to low cutting speed first choice for machining in interrupted cut
<h3>HTA</h3> <p>revêtement PVD PVD Beschichtung PVD coating</p>	<h3>AS</h3> <p>revêtement PVD PVD Beschichtung PVD coating</p>	<h3>N</h3> <p>non revêtu unbeschichtet uncoated</p>
<ul style="list-style-type: none"> très bonne résistance à l'usure pour le tronçonnage des aciers, aciers inoxydables et alliages de titane déconseillé en coupe interrompue 	<ul style="list-style-type: none"> nuance pour métaux non ferreux très faible coefficient de frottement 1^{er} choix pour l'usinage des aluminiums jusqu'à 5% Si, des cuivres et titanes faiblement alliés 	<ul style="list-style-type: none"> nuance pour les laitons, pour la géométrie PNW et PRW
<ul style="list-style-type: none"> sehr gute Verschleissfestigkeit für die Bearbeitung von Stahl, rostfreiem Stahl und Titanlegierung bestens geeignet für unterbrochene Schnitte ungeeignet 	<ul style="list-style-type: none"> Sorte für Nichteisenmetalle sehr geringer Reibwert für die Bearbeitung von Aluminium bis 5% Si, Kupfer und niedriglegiertem Titan bestens geeignet 	<ul style="list-style-type: none"> Sorte für Messing, für PNW und PRW Geometrie
<ul style="list-style-type: none"> very good wear resistance first choice for steel, stainless steel and titanium alloys machining not suitable for interrupted cut 	<ul style="list-style-type: none"> grade for non-ferrous materials very low friction ratio first choice for Aluminium up to 5% Si, copper and low alloyed titanium 	<ul style="list-style-type: none"> grade for brass, for PNW and PRW geometry

Géométries de coupe

Spanformgeometrie

Cutting geometries

UN

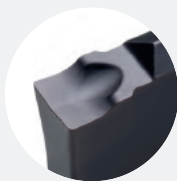
UR
UL

- géométrie positive universelle, bonne maîtrise du copeau
- allgemeine Geometrie, sehr gute Spankontrolle
- all-round insert with efficient chip control

PN

PR

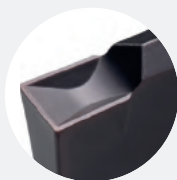

- géométrie légèrement positive pour les aciers, aciers au carbone, aciers alliés
- leicht positive Geometrie für Stahl, Kohlenstoffstahl, legiertem Stahl
- slightly positive geometry for steel, carbon steel, alloyed steel

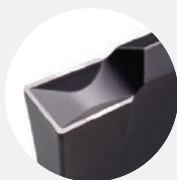
PNW
PRW

- géométrie neutre pour les laitons
- neutrale Geometrie für Messing
- neutral geometry for brasses

TN



- géométrie négative pour de fortes avances dans des conditions de rigidité favorable
- negative Geometrie für hohe Vorschübe in guten Stabilitätsfällen
- negative geometry for high feed rate in case of good stability

GN



- géométrie universelle pour fonçage-tournage, peut également être utilisée en tronçonnage
- allgemeine Geometrie zum einstecken-langdrehen, kann auch zum abstechen verwendet werden
- all-round insert for grooving and turning, can also be used for parting off







CUT-LINE

Paramètres de coupe indicatifs

Empfohlene Schnittwerte

Standard machining data

CUT 16

		P Acier Stahl Steel						M Inox Rostfreistahl Stainless steel		
		Acier de décolletage Automatenstahl Free-cutting steel		Acier faiblement allié Leicht legierter Stahl Low alloyed steel		Acier fortement allié Legierter Stahl High alloyed steel		Austénitique et martensitique Austenitisch und martensitisch Austenitic and martensitic		
		VC (m/min)	F (mm/U)	VC (m/min)	F (mm/U)	VC (m/min)	F (mm/U)	VC (m/min)	F (mm/U)	
Avance standard Standard Vorschub Standard feed rate	CUT16-UN-001 	TiAlN	90-140	0.03-0.07	60-120	0.03-0.07	50-100	0.04-0.08	50-120	0.03-0.07
		Tmax	100-170	0.03-0.07	70-150	0.03-0.07	60-120	0.04-0.08	60-150	0.03-0.07
		Zmax	80-130*	0.04-0.10	50-110*	0.04-0.10	50-90*	0.04-0.08	50-120*	0.04-0.10
		HTA	70-120	0.03-0.05	60-100	0.03-0.05	50-90	0.03-0.05	50-100	0.03-0.06
		AS								
	CUT16-PR-801 	TiAlN	90-140	0.03-0.07	60-120	0.03-0.07	50-100	0.03-0.07	50-120	0.03-0.07
Tmax	100-170	0.03-0.07	70-150	0.03-0.07	60-120	0.03-0.07	60-150	0.03-0.07		
CUT16-PRW-801 	N									
Avance modérée Niedriger Vorschub Low feed rate	CUT16-UN-000F 	TiAlN	80-130	0.02-0.05	50-110	0.02-0.05	50-90	0.02-0.05	50-80	0.02-0.05
		HTA	60-100	0.01-0.04	50-90	0.01-0.04	50-80	0.02-0.05	50-80	0.02-0.05
		AS								
	CUT16-UL/R-800F 	TiAlN	80-130	0.02-0.05	50-110	0.02-0.05	50-90	0.02-0.05	50-80	0.02-0.05
		HTA	60-100	0.01-0.04	50-90	0.01-0.04	50-80	0.02-0.05	50-80	0.02-0.05
		AS								
	CUT16-UL/R-1500F 	TiAlN	80-130	0.02-0.05	50-110	0.02-0.05	50-90	0.02-0.05	50-80	0.02-0.05
		HTA	60-100	0.01-0.04	50-90	0.01-0.04	50-80	0.02-0.05	50-80	0.02-0.05
		AS								

** arête de coupe vive

** scharfe Schneidkante

** sharp cutting edge

N Alliage d'aluminium et non ferreux Aluminium- und Nichteisenlegierungen Aluminium and non-ferrous alloys								S Titane Titan Titanium			
Aluminium		Alu silicium max. 5% Aluminiumsilicium max. 5% Aluminium silicon max. 5%		Cuivre Kupfer Copper		Laiton & bronze Messing & Bronze Brass & bronze		Gr. 1 - 3		Gr. 4 - 5	
VC (m/min)	F (mm/U)	VC (m/min)	F (mm/U)	VC (m/min)	F (mm/U)	VC (m/min)	F (mm/U)	VC (m/min)	F (mm/U)	VC (m/min)	F (mm/U)
100-250	0.03-0.10	100-250	0.03-0.10	100-300	0.03-0.10	100-300	0.03-0.10			30-60	0.04-0.08
100-300	0.04-0.10	100-250	0.04-0.10	100-300	0.03-0.08	150-300	0.03-0.08			30-60	0.04-0.08
150-300	0.04-0.15	100-300	0.04-0.10	100-300	0.04-0.10	150-300	0.02-0.08	30-60	0.04-0.08	30-60	0.04-0.08
						150-300	0.03-0.10				
						100-500	0.02-0.10				
100-300	0.02-0.05	100-250	0.01-0.04	100-250	0.01-0.04	100-300	0.02-0.05			30-60	0.01-0.04
100-300	0.02-0.05	100-250	0.02-0.05	100-250	0.02-0.05	100-300	0.02-0.05			30-60	0.02-0.06
100-300	0.02-0.05	100-250	0.02-0.05	100-250	0.02-0.05	100-300	0.02-0.05	30-60	0.02-0.06	30-60	0.02-0.06
100-300	0.02-0.05	100-250	0.01-0.04	100-250	0.01-0.04	100-300	0.02-0.05			30-60	0.01-0.04
100-300	0.02-0.05	100-250	0.02-0.05	100-250	0.02-0.05	100-300	0.02-0.05			30-60	0.02-0.06
100-300	0.02-0.05	100-250	0.02-0.05	100-250	0.02-0.05	100-300	0.02-0.05	30-60	0.02-0.06	30-60	0.02-0.06
100-300	0.02-0.05	100-250	0.01-0.04	100-250	0.01-0.04	100-300	0.02-0.05			30-60	0.01-0.04
100-300	0.02-0.05	100-250	0.02-0.05	100-250	0.02-0.05	100-300	0.02-0.05			30-60	0.02-0.06
100-300	0.02-0.05	100-250	0.02-0.05	100-250	0.02-0.05	100-300	0.02-0.05	30-60	0.02-0.06	30-60	0.02-0.06









CUT-LINE

Paramètres de coupe indicatifs

Empfohlene Schnittwerte

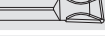
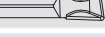
Standard machining data

CUT 22

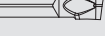
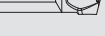
			P Acier Stahl Steel						M Inox Rostfreistahl Stainless steel	
			Acier de décolletage Automatenstahl Free-cutting steel		Acier faiblement allié Leicht legierter Stahl Low alloyed steel		Acier fortement allié Legierter Stahl High alloyed steel		Austénitique et martensitique Austenitisch und martensitisch Austenitic and martensitic	
			VC (m/min)	F (mm/U)	VC (m/min)	F (mm/U)	VC (m/min)	F (mm/U)	VC (m/min)	F (mm/U)
Avance standard Standard Vorschub Standard feed rate	CUT22-UN-002 CUT22-UR-802 	TiAlN	90-140	0.04-0.08	60-120	0.04-0.08	50-100	0.04-0.08	50-120	0.04-0.08
		Tmax	100-170	0.04-0.08	70-150	0.04-0.08	60-120	0.04-0.08	60-150	0.04-0.08
		Zmax	80-130*	0.04-0.10	50-110*	0.04-0.10	50-90*	0.04-0.08	50-120*	0.04-0.10
		HTA	70-120	0.04-0.06	60-100	0.04-0.06	50-90	0.04-0.06	50-100	0.04-0.06
		AS								
	CUT22-PN-002 	TiAlN	90-140	0.04-0.10	60-120	0.04-0.08	50-100	0.04-0.08		
	Tmax	100-170	0.04-0.10	70-150	0.04-0.10	60-120	0.04-0.10			
	CUT22-PNW-002 	N								
	CUT22-PR-002 	TiAlN	90-140	0.04-0.08	60-120	0.04-0.08	50-100	0.04-0.08	50-120	0.04-0.08
	Tmax	100-170	0.04-0.08	70-150	0.04-0.08	60-120	0.04-0.08	60-150	0.04-0.08	
CUT22-PRW-002 	N									
CUT22-TN-002 	TiAlN	90-140	0.08-0.18	60-120	0.08-0.18	50-100	0.08-0.15	50-120	0.08-0.20	
Tmax	100-170	0.08-0.18	70-150	0.08-0.18	60-120	0.08-0.15	60-150	0.08-0.20		
Zmax	80-130*	0.08-0.18	50-110*	0.08-0.18	50-90*	0.08-0.15				
CUT22-GN-002 *** 	TiAlN	90-140	0.03-0.12	60-120	0.03-0.12	50-100	0.03-0.10	50-120	0.03-0.08	
Tmax	100-170	0.03-0.12	70-150	0.03-0.12	60-120	0.03-0.10	70-120	0.03-0.08		
AS										
Avance modérée Niedriger Vorschub Low feed rate	CUT22-UN-000F 	TiAlN	80-130	0.02-0.05	50-110	0.02-0.05	50-90	0.02-0.05	50-80	0.02-0.05
		HTA	60-100	0.01-0.04	50-90	0.01-0.04	50-80	0.02-0.05	50-80	0.02-0.05
		AS								
	CUT22-UL/R-800F 	TiAlN	80-130	0.02-0.05	50-110	0.02-0.05	50-90	0.02-0.05	50-80	0.02-0.05
		HTA	60-100	0.01-0.04	50-90	0.01-0.04	50-80	0.02-0.05	50-80	0.02-0.05
		AS								
	CUT22-UL/R-802F 	TiAlN	80-130	0.02-0.05	50-110	0.02-0.05	50-90	0.02-0.05	50-80	0.02-0.05
		HTA	60-100	0.01-0.04	50-90	0.01-0.04	50-80	0.02-0.05	50-80	0.02-0.05
		AS								
	CUT22-UL/R-1500F 	TiAlN	80-130	0.02-0.05	50-110	0.02-0.05	50-90	0.02-0.05	50-80	0.02-0.05
		HTA	60-100	0.01-0.04	50-90	0.01-0.04	50-80	0.02-0.05	50-80	0.02-0.05
		AS								

* premier choix en cas de coupe interrompue

** arête de coupe vive

*** géométrie fonçage-tournage (évent. tronçonnage)

* beste Basis für unterbrochene Schnitte

** scharfe Schneidkante

*** Geometrie zum einstechen und drehen (event. abstechen)

* first choice for interrupted cut

** sharp cutting edge

*** geometry for grooving and turning (event. parting off)

N Allages d'aluminium et non ferreux Aluminium- und Nichteisenlegierungen Aluminium and non-ferrous alloys								S Titane Titan Titanium			
Aluminium		Alu silicium max. 5% Aluminiumsilicium max. 5% Aluminium silicium max. 5%		Cuivre Kupfer Copper		Laiton & bronze Messing & Bronze Brass & bronze		Gr. 1 - 3		Gr. 4 - 5	
VC (m/min)	F (mm/U)	VC (m/min)	F (mm/U)	VC (m/min)	F (mm/U)	VC (m/min)	F (mm/U)	VC (m/min)	F (mm/U)	VC (m/min)	F (mm/U)
100-250	0.03-0.10	100-250	0.03-0.10	100-300	0.03-0.10	100-300	0.03-0.10			30-60	0.04-0.08
100-300	0.04-0.10	100-250	0.04-0.10	100-300	0.03-0.08	150-300	0.03-0.08			30-60	0.04-0.08
150-300	0.04-0.15	100-300	0.04-0.10	100-300	0.04-0.10	150-300	0.02-0.08	30-60	0.04-0.08	30-60	0.04-0.08
						150-300	0.03-0.10				
						100-500	0.02-0.10				
						150-300	0.03-0.10				
						100-500	0.02-0.10				
						150-300	0.05-0.20				
100-300	0.03-0.12	100-200	0.03-0.10	100-200	0.03-0.10	100-300	0.03-0.12			30-60	0.04-0.08
						100-300	0.03-0.12				
100-300	0.03-0.12	100-200	0.03-0.10	100-200	0.03-0.10	100-300	0.03-0.12	30-60	0.04-0.08	30-60	0.04-0.08
100-300	0.02-0.05	100-250	0.01-0.04	100-250	0.01-0.04	100-300	0.02-0.05			30-60	0.01-0.04
100-300	0.02-0.05	100-250	0.02-0.05	100-250	0.02-0.05	100-300	0.02-0.05			30-60	0.02-0.06
100-300	0.02-0.05	100-250	0.02-0.05	100-250	0.02-0.05	100-300	0.02-0.05	30-60	0.02-0.06	30-60	0.02-0.06
100-300	0.02-0.05	100-250	0.01-0.04	100-250	0.01-0.04	100-300	0.02-0.05			30-60	0.01-0.04
100-300	0.02-0.05	100-250	0.02-0.05	100-250	0.02-0.05	100-300	0.02-0.05			30-60	0.02-0.06
100-300	0.02-0.05	100-250	0.02-0.05	100-250	0.02-0.05	100-300	0.02-0.05	30-60	0.02-0.06	30-60	0.02-0.06
100-300	0.02-0.05	100-250	0.01-0.04	100-250	0.01-0.04	100-300	0.02-0.05			30-60	0.01-0.04
100-300	0.02-0.05	100-250	0.02-0.05	100-250	0.02-0.05	100-300	0.02-0.05			30-60	0.02-0.06
100-300	0.02-0.05	100-250	0.02-0.05	100-250	0.02-0.05	100-300	0.02-0.05	30-60	0.02-0.06	30-60	0.02-0.06
100-300	0.02-0.05	100-250	0.01-0.04	100-250	0.01-0.04	100-300	0.02-0.05			30-60	0.01-0.04
100-300	0.02-0.05	100-250	0.02-0.05	100-250	0.02-0.05	100-300	0.02-0.05			30-60	0.02-0.06
100-300	0.02-0.05	100-250	0.02-0.05	100-250	0.02-0.05	100-300	0.02-0.05	30-60	0.02-0.06	30-60	0.02-0.06









CUT-LINE

Paramètres de coupe indicatifs

Empfohlene Schnittwerte

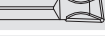
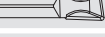
Standard machining data

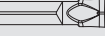
CUT 31

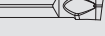
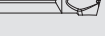
		P Acier Stahl Steel						M Inox Rostfreistahl Stainless steel		
		Acier de décolletage Automatenstahl Free-cutting steel		Acier faiblement allié Leicht legierter Stahl Low alloyed steel		Acier fortement allié Legierter Stahl High alloyed steel		Austénitique et martensitique Austenitisch und martensitisch Austenitic and martensitic		
		VC (m/min)	F (mm/U)	VC (m/min)	F (mm/U)	VC (m/min)	F (mm/U)	VC (m/min)	F (mm/U)	
Avance standard Standard Vorschub Standard feed rate	CUT31-UN-002 	TiAlN	90-140	0.04-0.08	60-120	0.04-0.08	50-100	0.04-0.08	50-120	0.04-0.10
		Tmax	100-170	0.04-0.08	70-150	0.04-0.08	60-120	0.04-0.08	60-150	0.04-0.10
		Zmax	80-130*	0.04-0.10	50-110*	0.04-0.10	50-90*	0.04-0.08	50-120*	0.04-0.10
		HTA	70-120	0.04-0.06	60-100	0.04-0.06	50-90	0.04-0.06	50-100	0.04-0.06
		AS								
	CUT31-PN-002 	TiAlN	90-140	0.04-0.10	60-120	0.04-0.08	50-100	0.04-0.08		
		Tmax	100-170	0.04-0.10	70-150	0.04-0.10	60-120	0.04-0.10		
	CUT31-PNW-002 	N								
	CUT31-PR-802 	TiAlN	90-140	0.04-0.08	60-120	0.04-0.08	50-100	0.04-0.08	50-120	0.04-0.08
		Tmax	100-170	0.04-0.08	70-150	0.04-0.08	60-120	0.04-0.08	60-150	0.04-0.08
CUT31-PRW-802 	N									
CUT31-TN-002 	TiAlN	90-140	0.08-0.20	60-120	0.08-0.20	50-100	0.08-0.15	50-120	0.08-0.20	
	Tmax	100-170	0.08-0.20	70-150	0.08-0.20	60-120	0.08-0.15	60-150	0.08-0.20	
	Zmax	80-130*	0.08-0.20	50-110*	0.08-0.20	50-90*	0.08-0.15			
CUT31-GN-002 *** 	TiAlN	90-140	0.04-0.15	60-120	0.04-0.15	50-100	0.04-0.10	50-120	0.04-0.10	
	Tmax	100-170	0.04-0.15	70-150	0.04-0.15	60-120	0.04-0.10	70-120	0.04-0.10	
	AS									
Avance modérée Niedriger Vorschub Low feed rate	CUT31-UN-000F 	TiAlN	80-130	0.02-0.05	50-110	0.02-0.05	50-90	0.02-0.05	50-80	0.02-0.05
		HTA	60-100	0.01-0.04	50-90	0.01-0.04	50-80	0.02-0.05	50-80	0.02-0.05
		AS								
	CUT31-UL/R-800F 	TiAlN	80-130	0.02-0.05	50-110	0.02-0.05	50-90	0.02-0.05	50-80	0.02-0.05
		HTA	60-100	0.01-0.04	50-90	0.01-0.04	50-80	0.02-0.05	50-80	0.02-0.05
		AS								
	CUT31-UL/R-802F 	TiAlN	80-130	0.02-0.05	50-110	0.02-0.05	50-90	0.02-0.05	50-80	0.02-0.05
		HTA	60-100	0.01-0.04	50-90	0.01-0.04	50-80	0.02-0.05	50-80	0.02-0.05
		AS								
	CUT31-UL/R-1500F 	TiAlN	80-130	0.02-0.05	50-110	0.02-0.05	50-90	0.02-0.05	50-80	0.02-0.05
		HTA	60-100	0.01-0.04	50-90	0.01-0.04	50-80	0.02-0.05	50-80	0.02-0.05
		AS								

* premier choix en cas de coupe interrompue

** arête de coupe vive

*** géométrie fonçage-tournage (évent. tronçonnage)

* beste Basis für unterbrochene Schnitte

** scharfe Schneidkante

*** Geometrie zum einstechen und drehen (event. abstechen)

* first choice for interrupted cut

** sharp cutting edge

*** geometry for grooving and turning (event. parting off)

N Allages d'aluminium et non ferreux Aluminium- und Nichteisenlegierungen Aluminium and non-ferrous alloys								S Titane Titan Titanium			
Aluminium		Alu silicium max. 5% Aluminiumsilicium max. 5% Aluminium silicium max. 5%		Cuivre Kupfer Copper		Laiton & bronze Messing & Bronze Brass & Bronze		Gr. 1 - 3		Gr. 4 - 5	
VC (m/min)	F (mm/U)	VC (m/min)	F (mm/U)	VC (m/min)	F (mm/U)	VC (m/min)	F (mm/U)	VC (m/min)	F (mm/U)	VC (m/min)	F (mm/U)
100-250	0.03-0.10	100-250	0.03-0.10	100-300	0.03-0.10	100-300	0.03-0.10			30-60	0.04-0.08
100-300	0.04-0.10	100-250	0.04-0.10	100-300	0.03-0.08	150-300	0.03-0.08			30-60	0.04-0.08
150-300	0.04-0.15	100-300	0.04-0.10	100-300	0.04-0.10	150-300	0.02-0.08	30-60	0.04-0.08	30-60	0.04-0.08
						150-300	0.03-0.10				
						100-500	0.02-0.15				
						150-300	0.03-0.10				
						100-500	0.02-0.15				
						150-300	0.05-0.20				
100-300	0.04-0.15	100-200	0.04-0.10	100-200	0.04-0.10	100-300	0.04-0.15			30-60	0.04-0.08
						100-300	0.04-0.15				
100-300	0.04-0.15	100-200	0.04-0.10	100-200	0.04-0.10	100-300	0.04-0.15	30-60	0.04-0.08	30-60	0.04-0.08
100-300	0.02-0.05	100-250	0.01-0.04	100-250	0.01-0.04	100-300	0.02-0.05			30-60	0.01-0.04
100-300	0.02-0.05	100-250	0.02-0.05	100-250	0.02-0.05	100-300	0.02-0.05			30-60	0.02-0.06
100-300	0.02-0.05	100-250	0.02-0.05	100-250	0.02-0.05	100-300	0.02-0.05	30-60	0.02-0.06	30-60	0.02-0.06
100-300	0.02-0.05	100-250	0.01-0.04	100-250	0.01-0.04	100-300	0.02-0.05			30-60	0.01-0.04
100-300	0.02-0.05	100-250	0.02-0.05	100-250	0.02-0.05	100-300	0.02-0.05			30-60	0.02-0.06
100-300	0.02-0.05	100-250	0.02-0.05	100-250	0.02-0.05	100-300	0.02-0.05	30-60	0.02-0.06	30-60	0.02-0.06
100-300	0.02-0.05	100-250	0.01-0.04	100-250	0.01-0.04	100-300	0.02-0.05			30-60	0.01-0.04
100-300	0.02-0.05	100-250	0.02-0.05	100-250	0.02-0.05	100-300	0.02-0.05			30-60	0.02-0.06
100-300	0.02-0.05	100-250	0.02-0.05	100-250	0.02-0.05	100-300	0.02-0.05	30-60	0.02-0.06	30-60	0.02-0.06
100-300	0.02-0.05	100-250	0.01-0.04	100-250	0.01-0.04	100-300	0.02-0.05			30-60	0.01-0.04
100-300	0.02-0.05	100-250	0.02-0.05	100-250	0.02-0.05	100-300	0.02-0.05			30-60	0.02-0.06
100-300	0.02-0.05	100-250	0.02-0.05	100-250	0.02-0.05	100-300	0.02-0.05	30-60	0.02-0.06	30-60	0.02-0.06



CUT-LINE

Porte-outils

Halter

Holders

Ø max 34 mm

H Series

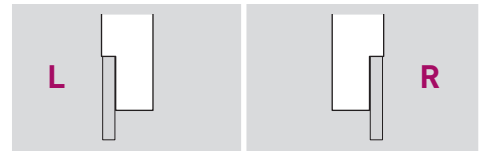
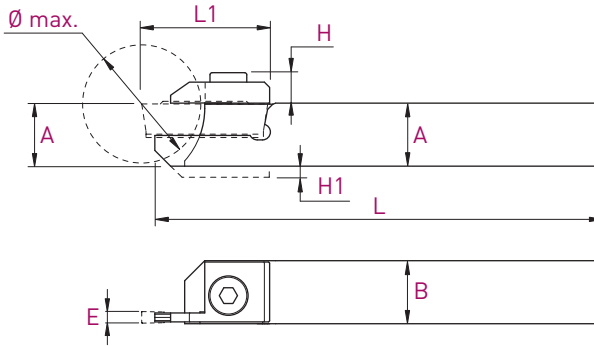

Plaquettes WSP Inserts	A x B	L	Ø max.	L1	H	H1	Art. N°	Art. N°
E 1.6 mm Type CUT16	8 x 10	115	16	19.5	6.2	2	CUT16-H0810L	CUT16-H0810R
	10 x 10	115	16	19.5	6.2	-	CUT16-H1010L	CUT16-H1010R
	12 x 12	130	16	19.5	6.2	-	CUT16-H1212L	CUT16-H1212R
	12 x 12	90	16	19.5	6.2	-	CUT16-H1212L-90	CUT16-H1212R-90
	12.7 x 12.7	130	16	19.5	6.2	-	CUT16-H127127L	CUT16-H127127R
	16 x 16	130	16	19.5	6.2	-	CUT16-H1616L	CUT16-H1616R
20 x 20	120	16	19.5	6.2	-	CUT16-H2020L	CUT16-H2020R	
E 2.2 mm Type CUT22	10 x 12	115	20	24	6.4	-	CUT22-H1012L	CUT22-H1012R
	12 x 12	130	20	24	6.4	-	CUT22-H1212L	CUT22-H1212R
	12 x 12	90	20	24	6.4	-	CUT22-H1212L-90	CUT22-H1212R-90
	12.7 x 12.7	130	20	24	6.4	-	CUT22-H127127L	CUT22-H127127R
	16 x 16	130	20	24	6.4	-	CUT22-H1616L	CUT22-H1616R
	20 x 20	120	20	24	6.4	-	CUT22-H2020L	CUT22-H2020R
E 3.1 mm Type CUT31	16 x 16	130	34	35	7.8	-	CUT31-H1616L	CUT31-H1616R
	20 x 20	120	34	35	7.8	-	CUT31-H2020L	CUT31-H2020R
	25 x 25	140	34	35	7.8	-	CUT31-H2525L	CUT31-H2525R

Pièces de rechange Ersatzteile Spare parts	L	R	Serrage Anzug Torque	
	Art. N°	Art. N°		Art. N°
CUT 16	CUT16L-SET	CUT16R-SET	V-M4X10-BN7	3.5 Nm
CUT 22	CUT22L-SET	CUT22R-SET	V-M4X10-BN7	3.5 Nm
CUT 31	CUT31L-SET	CUT31R-SET	V-M5X10-BN7	4.5 Nm

Porte-outils

Halter

Holders

Ø max 42 mm

HX Series

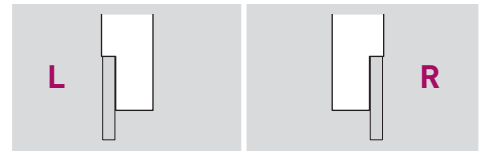
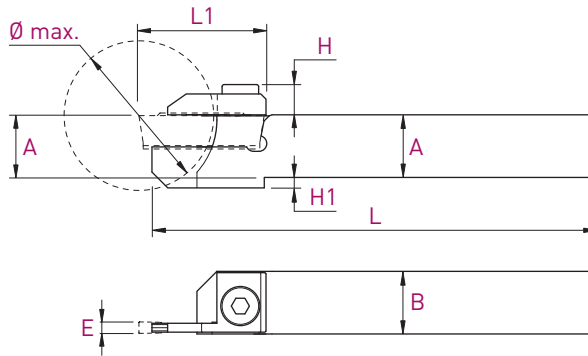

Plaquettes WSP Inserts	A x B	L	Ø max.	L1	H	H1	Art. N°	Art. N°
E 1.6 mm Type CUT16	10 x 12	115	20	21	6.2	2	CUT16-H1012LX	CUT16-H1012RX
	12 x 12	130	20	21	6.2	-	CUT16-H1212LX	CUT16-H1212RX
	12 x 12	90	20	21	6.2	-	CUT16-H1212LX-90	CUT16-H1212RX-90
	12.7 x 12.7	130	20	21	6.2	-	CUT16-H127127LX	CUT16-H127127RX
	16 x 16	130	20	21	6.2	-	CUT16-H1616LX	CUT16-H1616RX
	20 x 20	120	20	21	6.2	-	CUT16-H2020LX	CUT16-H2020RX
E 2.2 mm Type CUT22	10 x 12	115	26	25	6.4	4	CUT22-H1012LX	CUT22-H1012RX
	12 x 12	130	26	25	6.4	2	CUT22-H1212LX	CUT22-H1212RX
	12 x 12	90	26	25	6.4	2	CUT22-H1212LX-90	CUT22-H1212RX-90
	12.7 x 12.7	130	26	25	6.4	-	CUT22-H127127LX	CUT22-H127127RX
	16 x 16	130	26	25	6.4	-	CUT22-H1616LX	CUT22-H1616RX
	20 x 20	120	26	25	6.4	-	CUT22-H2020LX	CUT22-H2020RX
E 3.1 mm Type CUT31	16 x 16	120	42	37	7.8	4	CUT31-H1616LX	CUT31-H1616RX
	20 x 20	120	42	37	7.8	-	CUT31-H2020LX	CUT31-H2020RX
	25 x 25	140	42	37	7.8	-	CUT31-H2525LX	CUT31-H2525RX

Pièces de rechange Ersatzteile Spare parts	L	R		Serrage Anzug Torque
	Art. N°	Art. N°	Art. N°	
CUT 16	CUT16LX-SET	CUT16RX-SET	V-M4X10-BN7	3.5 Nm
CUT 22	CUT22LX-SET	CUT22RX-SET	V-M4X10-BN7	3.5 Nm
CUT 31	CUT31LX-SET	CUT31RX-SET	V-M5X10-BN7	4.5 Nm

CUT-LINE

Porte-outils

Halter

Holder

Ø max 65 mm

HZ Series

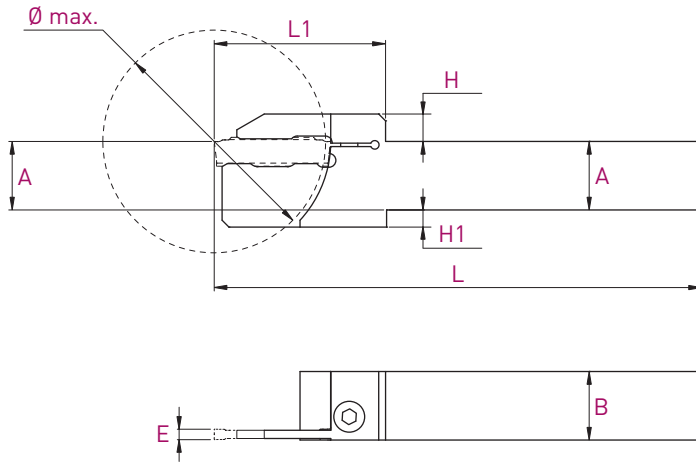

Plaquettes WSP Inserts	A x B	L	Ø max.	L1	H	H1	Art. N°	Art. N°
E 2.2 mm	16 x 16	130	32	30	7	-	CUT22-H1616LZ-D32	CUT22-H1616RZ-D32
	20 x 20	130	32	30	7	-	CUT22-H2020LZ-D32	CUT22-H2020RZ-D32
Type CUT22	16 x 16	130	42	35	7	4	CUT22-H1616LZ-D42	CUT22-H1616RZ-D42
	20 x 20	130	42	35	7	-	CUT22-H2020LZ-D42	CUT22-H2020RZ-D42
E 3.1 mm	20 x 20	140	52	44	8	5	CUT31-H2020LZ-D52	CUT31-H2020RZ-D52
	25 x 25	140	52	44	8	-	CUT31-H2525LZ-D52	CUT31-H2525RZ-D52
Type CUT31	20 x 20	140	65	50	8	5	CUT31-H2020LZ-D65	CUT31-H2020RZ-D65
	25 x 25	140	65	50	8	-	CUT31-H2525LZ-D65	CUT31-H2525RZ-D65

Pièces de rechange Ersatzteile Spare parts		Serrage Anzug Torque
	Art. N°	
CUT 22	V-M4X10-BN7	3.5 Nm
CUT 31	V-M5X10-BN7	4.5 Nm

Porte-outils avec arrosage intégré
 Halter mit integrierter Kühlmittelzufuhr
 Holders with integrated coolant supply

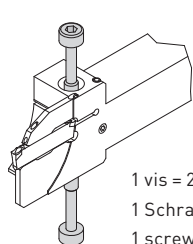
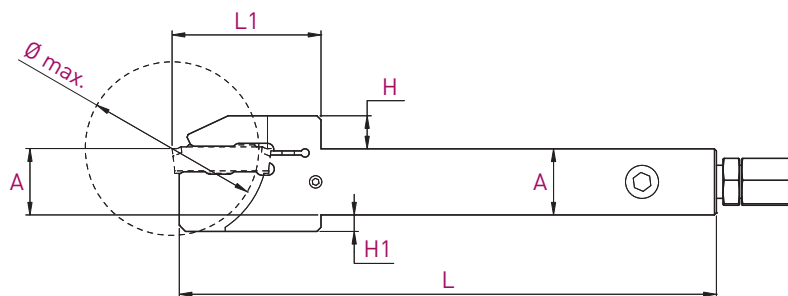

HZ-JET Series

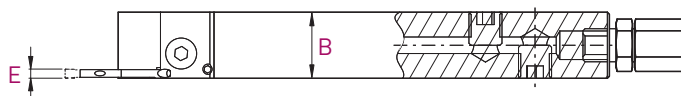

1 vis = 2 possibilités de serrage
 1 Schraube = 2 Spannmöglichkeiten
 1 screw = 2 clamp possibilities

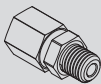

Plaquettes WSP Inserts	A x B	L	Ø max.	L1	H	H1	Art. N°	Art. N°
E 2.2 mm	16 x 16	130	42	36	8	4	CUT22-H1616LZ-JET42	CUT22-H1616RZ-JET42
Type CUT22	20 x 20	130	42	36	8	-	CUT22-H2020LZ-JET42	CUT22-H2020RZ-JET42
E 3.1 mm	16 x 16	140	65	49	9	9	CUT31-H1616LZ-JET65	CUT31-H1616RZ-JET65
Type CUT31	20 x 20	140	65	51	9	5	CUT31-H2020LZ-JET65	CUT31-H2020RZ-JET65
	25 x 25	140	65	51	9	-	CUT31-H2525LZ-JET65	CUT31-H2525RZ-JET65

Pièces de rechange Ersatzteile Spare parts		Serrage Anzug Torque		
	Art. N°		Art. N°	Art. N°
CUT 22	V-M4X22-CUT	3.5 Nm	J-M8X1-D6	JB-M8X1
CUT 31	V-M5X25-CUT	4.5 Nm	J-M8X1-D6	JB-M8X1

CUT-LINE

Plaquettes de tronçonnage
 Abstechwendeplatten
 Cut off inserts

UN Series

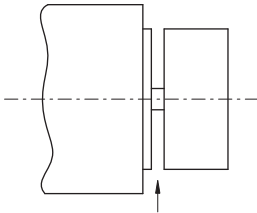
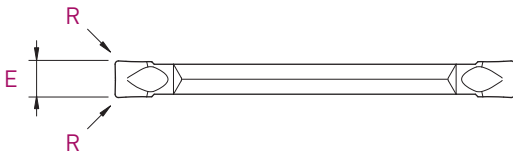
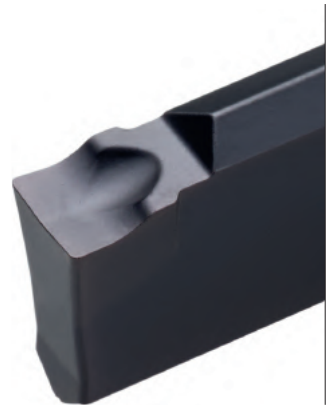
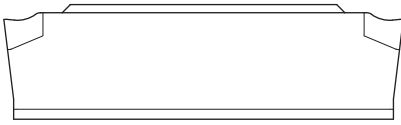

Type	E \pm 0.1	R	Art. N°	TiAlN	Tmax	Zmax	HTA	AS
CUT16	1.6	0.02	CUT16-UN-000F	■			■	■
	1.6	0.10	CUT16-UN-001	■	■	■	■	■
CUT22	2.2	0.02	CUT22-UN-000F	■			■	■
	2.2	0.20	CUT22-UN-002	■	■	■	■	■
CUT31	3.1	0.02	CUT31-UN-000F	■			■	■
	3.1	0.20	CUT31-UN-002	■	■	■	■	■

Plaquettes de tronçonnage

Abstechwendeplatten

Cut off inserts

UL-UR Series

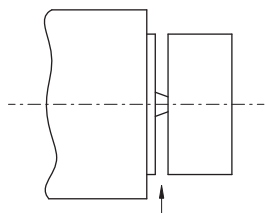
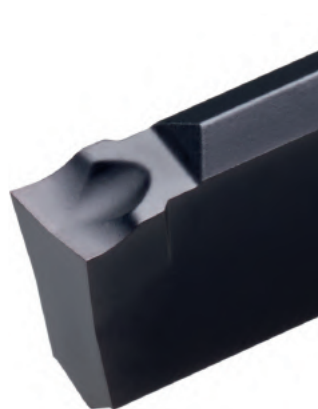
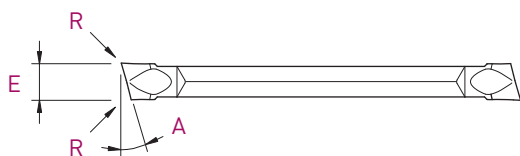
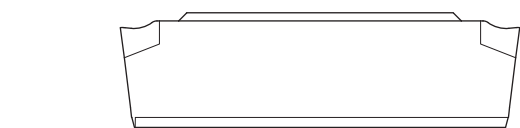

				UL			UR						
Type	E ±0.1	A	R	Art. N°	TiAlN	HTA	AS	Art. N°	TiAlN	Tmax	Zmax	HTA	AS
CUT16	1.6	8°	0.02	CUT16-UL-800F	■	■	■	CUT16-UR-800F	■			■	■
	1.6	15°	0.02	CUT16-UL-1500F	■	■	■	CUT16-UR-1500F	■			■	■
CUT22	2.2	8°	0.02	CUT22-UL-800F	■	■	■	CUT22-UR-800F	■			■	■
	2.2	8°	0.20	-				CUT22-UR-802		■	■		
	2.2	8°	0.20	CUT22-UL-802F	■	■	■	CUT22-UR-802F	■			■	■
	2.2	15°	0.02	CUT22-UL-1500F	■	■	■	CUT22-UR-1500F	■			■	■
CUT31	3.1	8°	0.02	CUT31-UL-800F	■	■	■	CUT31-UR-800F	■			■	■
	3.1	8°	0.20	CUT31-UL-802F	■	■	■	CUT31-UR-802F	■			■	■
	3.1	15°	0.02	CUT31-UL-1500F	■	■	■	CUT31-UR-1500F	■			■	■

CUT-LINE

Plaquettes de tronçonnage

Abstechwendeplatten

Cut off inserts

PN Series

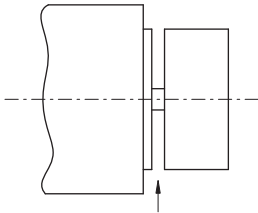
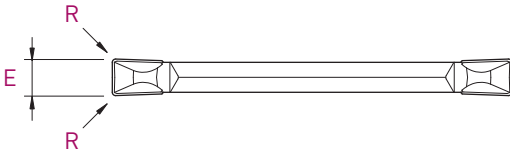
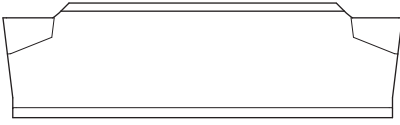

Type	E ±0.1	R	Art. N°	Trial	Tmax
CUT22	2.2	0.20	CUT22-PN-002	■	■
CUT31	3.1	0.20	CUT31-PN-002	■	■

Plaquettes de tronçonnage

Abstechwendeplatten

Cut off inserts

PR Series

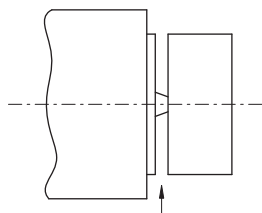
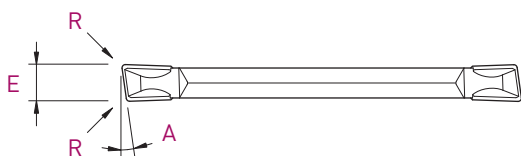
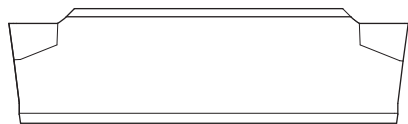

Type	E ±0.1	A	R	Art. N°	TiAlN	Tmax
CUT16	1.6	8°	0.10	CUT16-PR-801	■	■
CUT22	2.2	8°	0.20	CUT22-PR-802	■	■
CUT31	3.1	8°	0.20	CUT31-PR-802	■	■

CUT-LINE

Plaquettes de tronçonnage
 Abstechwendeplatten
 Cut off inserts

PNW Series

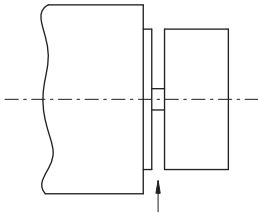
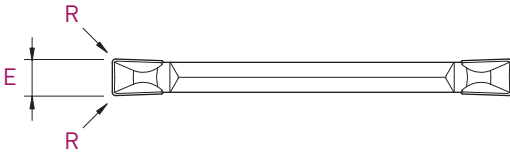
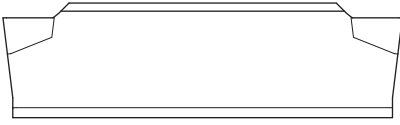

Type	E ± 0.1	R	Art. N°	Z
CUT22	2.2	0.20	CUT22-PNW-002	■
CUT31	3.1	0.20	CUT31-PNW-002	■

Plaquettes de tronçonnage

Abstechwendeplatten

Cut off inserts

PRW Series

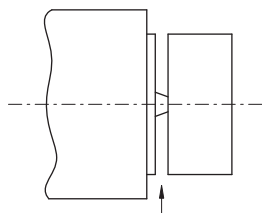
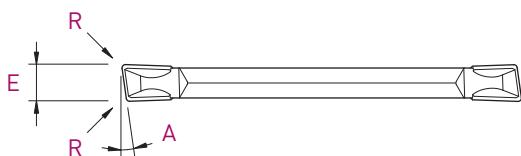
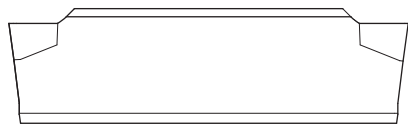

PRW



Type	E ±0.1	A	R	Art. N°	z
CUT16	1.6	8°	0.10	CUT16-PRW-801	■
CUT22	2.2	8°	0.20	CUT22-PRW-802	■
CUT31	3.1	8°	0.20	CUT31-PRW-802	■

CUT-LINE

Plaquettes de tronçonnage
 Abstechwendeplatten
 Cut off inserts

Negative geometry

TN Series

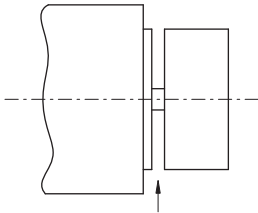
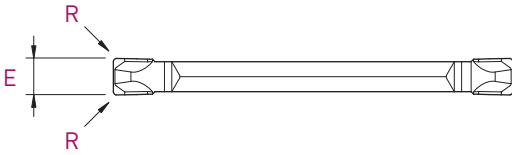
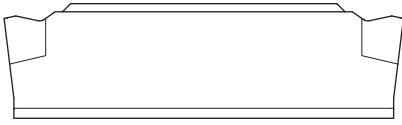

Type	E ±0.1	R	Art. N°	TiAlN	Tmax	Zmax
CUT22	2.2	0.20	CUT22-TN-002	■	■	■
CUT31	3.1	0.20	CUT31-TN-002	■	■	■

Plaquettes de fonçage, tournage et tronçonnage
 WSP zum einstecken, drehen und abstechen
 Solid carbide inserts for grooving, turning and cut off

GN Series

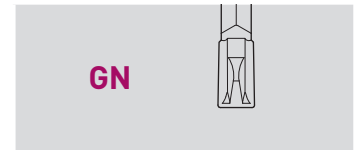
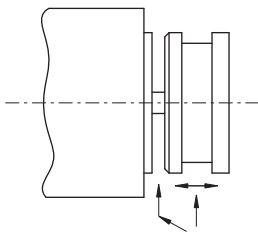
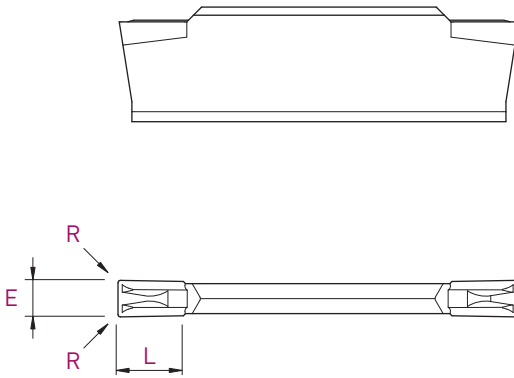

Type	E ±0.1	L	R	Art. N°	TiAlN	Tmax	AS
CUT22	2.2	3.5	0.15	CUT22-GN-002	■	■	■
CUT31	3.1	5.0	0.15	CUT31-GN-002	■	■	■

Conseils d'utilisation pour plaquettes type GN
 Anwendungsempfehlungen für GN-Wendeleplatten
 Application recommendations for GN inserts

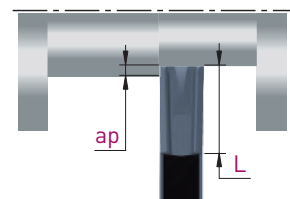
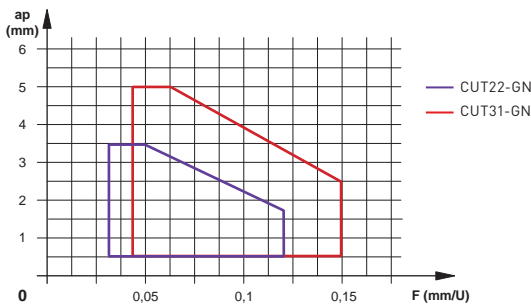

$a_p \text{ max} = T$ dans matière à bonne usinabilité
 $a_p \text{ max} = T$ in Werkstoffe mit gute Zerspanbarkeit
 $a_p \text{ max} = T$ in material with good machinability

BH

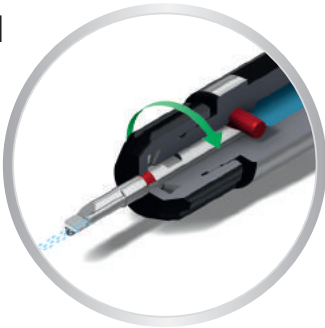

BHS

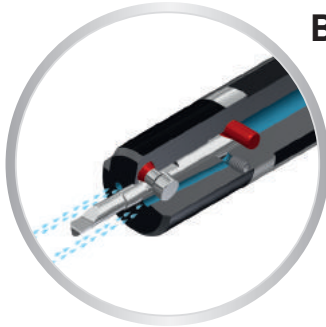

BHY

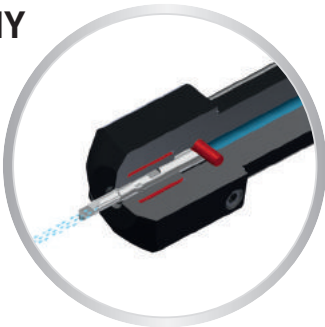

BHK

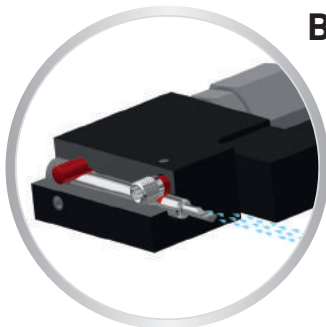

Système de désignation
Bezeichnungssystem
Designation system **Info** > **10.02**

Nuances & paramètres de coupe
Sorten & Schnittwerte
Grades & machining data > **10.08**

Porte-outils
Halter
Holders **BH / BHS / BHY / BHK** > **10.10**

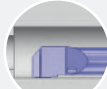
Alésage
Ausbohren
Boring **BA / BAX**  > **10.20**

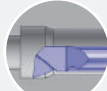

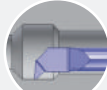
Alésage-copiage
Ausbohren-kopieren
Boring chambering **BCX**  > **10.24**

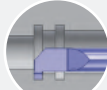
Copiage
Kopieren
Chambering **C45 / C45X**  > **10.26**

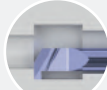
Gorge
Einstechen
Grooving **GX**  > **10.30**

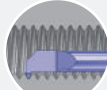
Fonçage-tournage
Einstechen und drehen
Grooving and turning **GTX**  > **10.32**

Filetage
Gewindedrehen
Threading **TP60° / TP55° / TM**  > **10.34**

Gorge frontale
Axiales Stechen
Axial grooving **FEG / FIG**   > **10.40**

Ébauches / Jauges d'alignement / Adaptations machines / Accessoires
Rohlinge / Richtplatten / Maschinenanpassungen / Zubehöre
Blanks / Adjusting tools / Machines adapters / Accessories > **10.42**

Système de désignation des porte-outils

Halter Bezeichnungssystem

Holders designation system

BHK

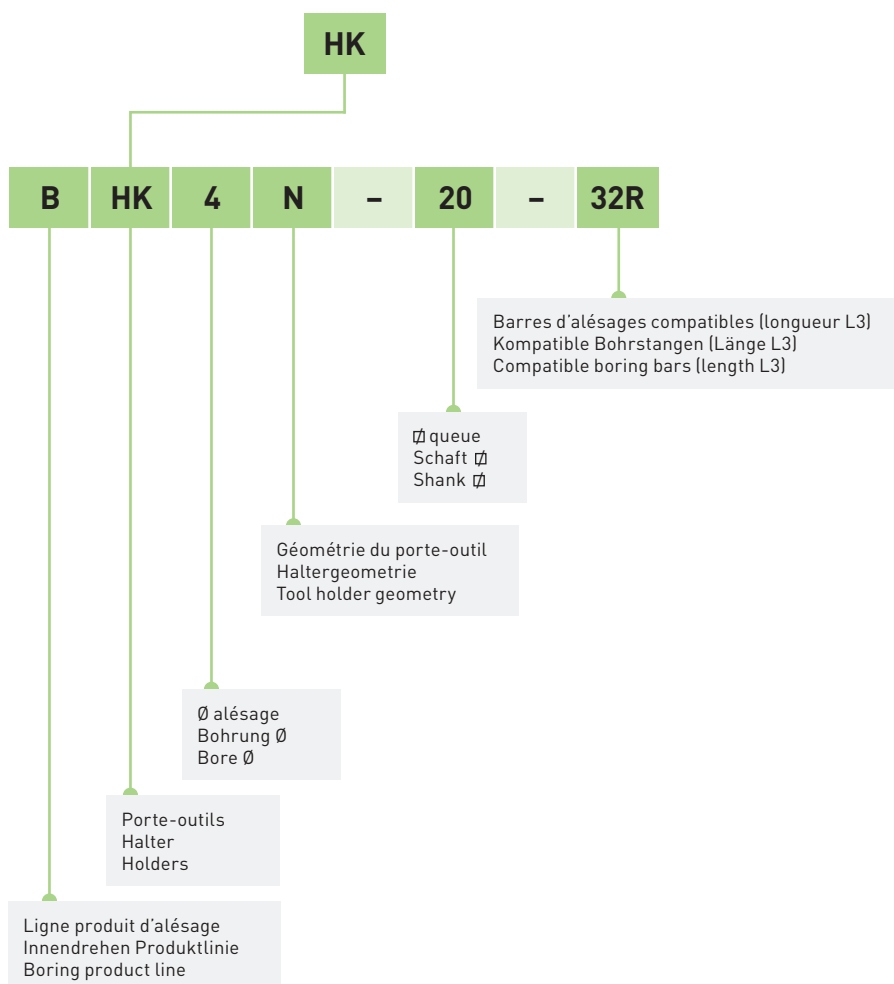
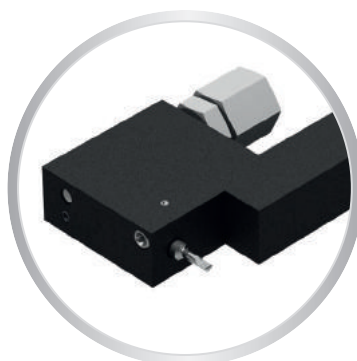

Système de désignation des barres d'alésage

Bohrstangen Bezeichnungssystem

Boring bars designation system

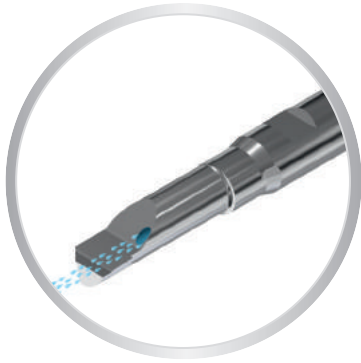

B

F

B B 4 R - 25 - 75 - BAX - R05 - ZN

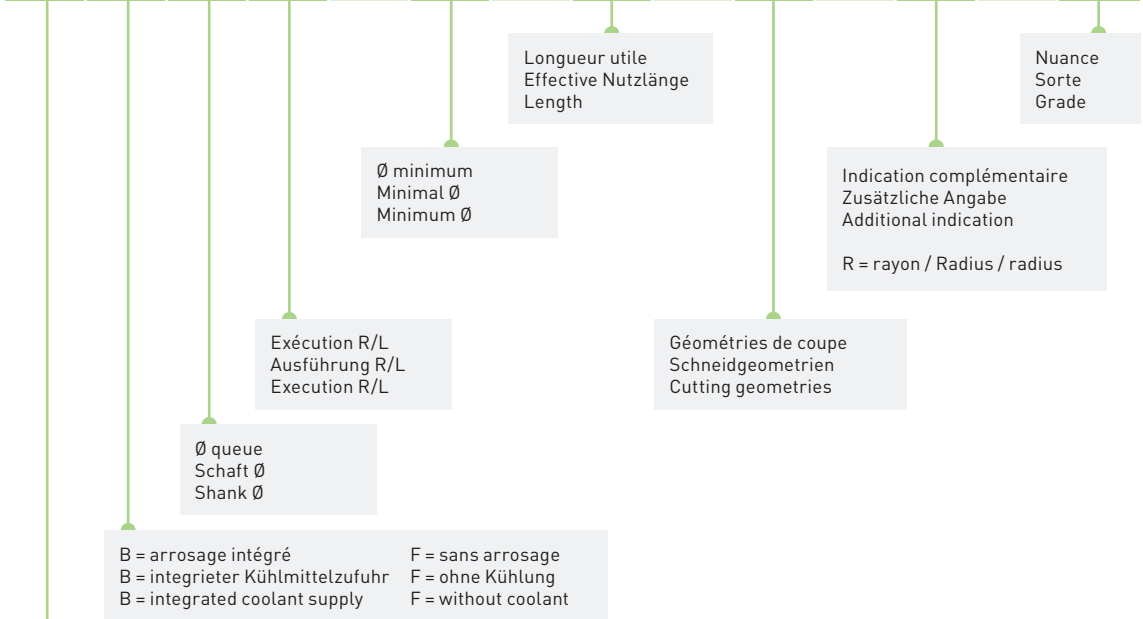

Porte-outils avec écrou de serrage

Halter mit Spannmutter

Tool holders with clamping nut

BH-D

Arrosage par la barre d'alésage

Kühlung durch die Bohrstange

Cooling through the boring bar

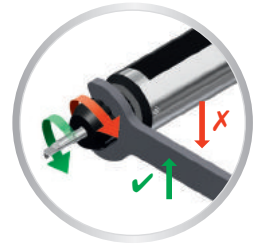
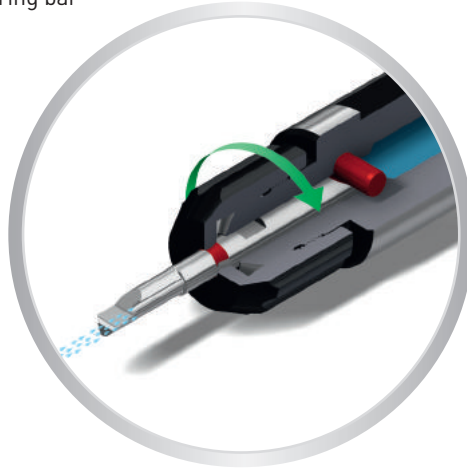

Porte-outils avec arrosage multiple

Halter mit mehrfaches Kühlungssystem

Tool holders with multiple coolant system

BHS-D

Système de serrage à vis transversale

Querverschraubungssystem

Clamping system with transverse screw

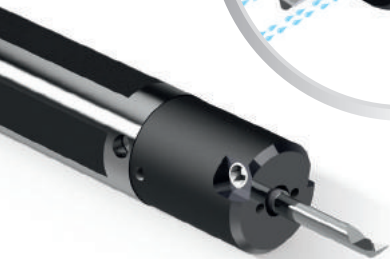
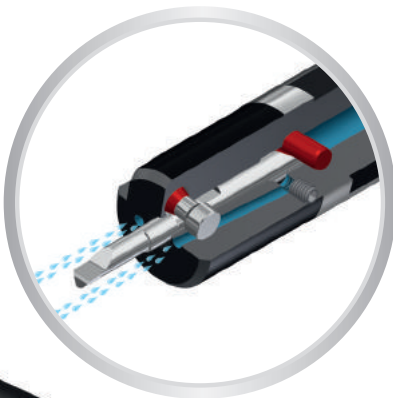

Arrosage sur l'arête de coupe

Kühlung auf der Schneidkante

Cooling on the cutting edge

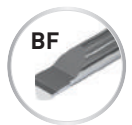
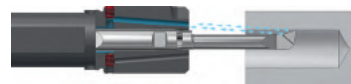

Arrosage favorisant l'évacuation des copeaux

Spanabfuhr fördernde Kühlung

Cooling for better chip outflow

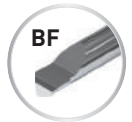
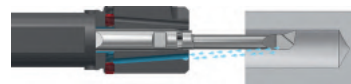

Arrosage par le centre de l'outil

Zentrale Kühlmittelzufuhr

Cooling through the center of the tool

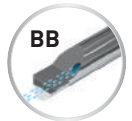

IN-LINE

- Porte-outils à serrage hydraulique
- Halter mit Hydro-Dehnspann-System
- Tool holders with hydraulic clamping system

BHY



Excellente absorption des vibrations!
Ausgezeichnete Schwingungsdämpfung!
Excellent vibration absorbtion!

Arrosage par la barre d'alésage
Kühlung durch die Bohrstange
Cooling through the boring bar

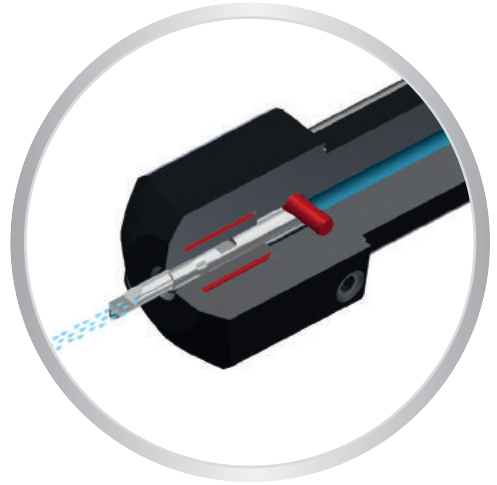

- Porte-outils coudés
- Gekröpfte Halter
- Cranked tool holders

BHK

Système de serrage à vis transversale
Querverschraubungssystem
Clamping system with transverse screw

Arrosage par la barre d'alésage
Kühlung durch die Bohrstange
Cooling through the boring bar

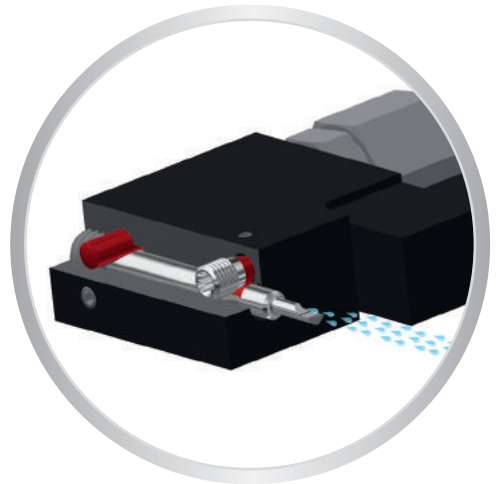
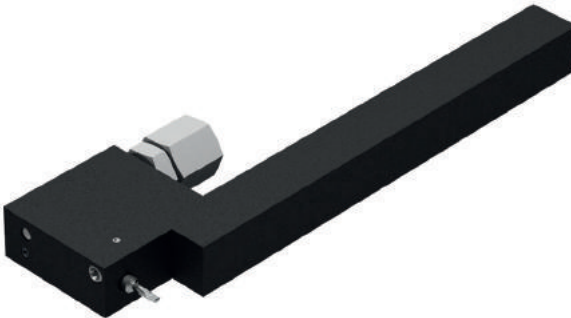

Accessoires de serrage

Spannzubehöre

Clamping accessories

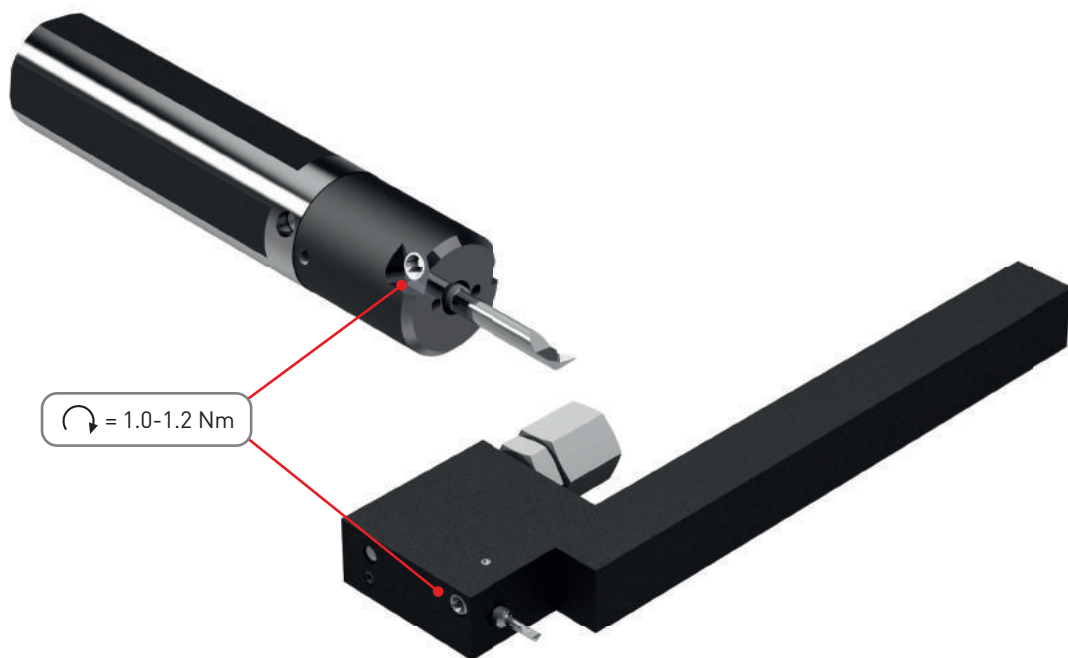

Nous recommandons le serrage des porte-outils types BHS et BHK avec ce type de tournevis dynamométrique.

Wir empfehlen für das Anziehen der Halter Typ BHS und BHK diese Art von Drehmomentschraubendreher.

For holders type BHS and BHK clamping, we recommend this kind of torque screwdriver.



Art. N°

SET-NM1.2-TX8

Nuances

Sorten

Grades

P

M

N

S

ZTAF

ZN + revêtement PVD
ZN + PVD Beschichtung
ZN + PVD coating

- nuance universelle pour l'usinage des aciers, aciers inoxydables, aciers alliés, alliage de titane
- bonne résistance à la température

- Universalsorte für die Bearbeitung von Stahl, rostfreiem Stahl, Stahllegierung, Titanlegierung
- gute Warmfestigkeit

- universal grade for steel, stainless steel, alloyed steel, titanium alloys
- good heat resistance

P

M

S

ZTAXF

ZN + revêtement PVD
ZN + PVD Beschichtung
ZN + PVD coating

- nuance très résistante à l'usure et à la température, recommandée pour l'usinage des matières suivantes: Inox 304, 316L, 317L, 904, Phynox
- aciers alliés contenant: Chrome Nickel, Vanadium, Molybdène, ...

- sehr verschleissfeste und temperaturbeständige Sorte. Für folgende Materialien empfohlen: Inox 304, 316L, 317L, 904, Phynox
- legierter Stahl enthaltend: Chrom-Nickel, Vanadium, Molybdän, ...

- very wear and high temperature resistant grade. Recommended for following material: Inox 304, 316L, 317L, 904, Phynox
- alloy steel containing: Chrome-nickel, Vanadium, Molybdenum, ...

P

N

S

ZN

non revêtu
unbeschichtet
uncoated

- nuance de base micro-grain tenace
- 1^{er} choix pour l'usinage des métaux non ferreux

- zähe Basis Feinkornsorte
- beste Wahl für die Bearbeitung von Nichteisenmetalle

- tough base micro-grain grade
- first choice for non-ferrous materials

Paramètres de coupe

Schnittwerte

Machining data

Matière Werkstoff Material	VC (m/min)	Ø barre d'alésage Bohrstange Ø boring bar Ø		
		Ø1.0 - Ø2.0 (mm/U)	Ø2.5 - Ø4.0 (mm/U)	Ø4.5 - Ø5.5 (mm/U)
Acier de décolletage Automatenstahl Free-cutting steel (P)	60-100	0.02-0.03	0.02-0.08	0.03-0.10
Acier faiblement allié Leicht legierter Stahl Low alloyed steel (P)	50-80	0.01-0.03	0.02-0.05	0.03-0.06
Acier fortement allié Legierter Stahl High alloyed steel (P)	40-60	0.01-0.02	0.02-0.04	0.02-0.06
Acier inoxydable Rostfreistahl Stainless steel (M)	40-90	0.01-0.03	0.02-0.05	0.03-0.08
Aluminium (N)	60-150	0.01-0.03	0.02-0.06	0.03-0.10
Cuivre, laiton, bronze Kupfer, Messing, Bronze Copper, brass, bronze (N)	60-150	0.01-0.03	0.02-0.05	0.03-0.08
Titane Titan Titanium (S)	30-70	0.01-0.03	0.02-0.05	0.03-0.10

Porte-outils avec écrou de serrage

Halter mit Spannmutter

Tool holders with clamping nut

BH4-D



> page 10.05

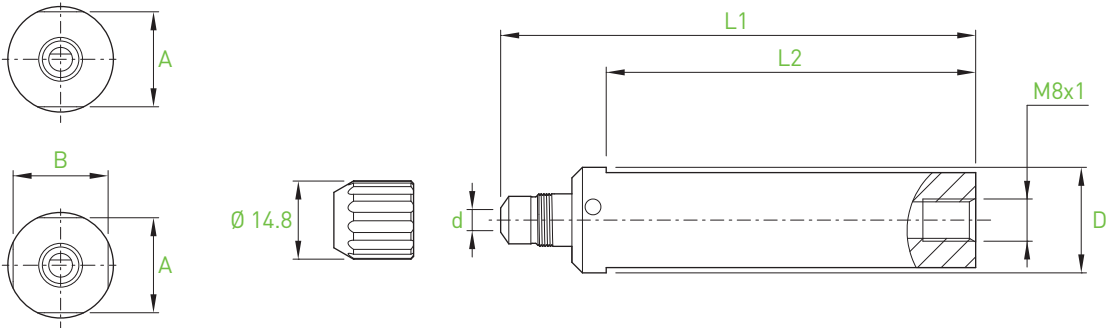

d	Bars	D	L1	L2	A x B	2 flats	4 flats	Art. N°
4	BB4... BF4...	10	75	55	8.8x8.8	■		BH4-D10-75
		12	75	55	11.2x11.2	■		BH4-D12-75
		12.7	75	55	11.2x11.2	■		BH4-D12.7-75
		15.87	75	55	14x14	■		BH4-D15.87-75
		16	75	55	14x14	■		BH4-D16-75
		16	75	55	14x14		■	BH4-D16-75-F4
		19.05	90	70	17x17	■		BH4-D19.05-90
		20	90	70	18x18	■		BH4-D20-90
		20	90	70	18x18		■	BH4-D20-90-F4
		20	160	140	18x18		■	BH4-D20-160-F4
		22	90	70	20x20	■		BH4-D22-90
		22	90	70	20x20		■	BH4-D22-90-F4
		22	130	110	20x20		■	BH4-D22-130-F4
		25	100	80	23x23	■		BH4-D25-100
		25	100	80	23x23		■	BH4-D25-100-F4
		25	170	150	23x23		■	BH4-D25-170-F4
25.4	100	80	23.4x23.4	■		BH4-D25.4-100		
28	100	80	26x26	■		BH4-D28-100		

Pièces de rechange
Ersatzteile
Spare parts



Art. N°



Art. N°

BH4...

BH4-M10

C-BH4-M10

Option

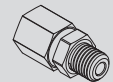

Art. N°

BH4...

J-M8X1-D6

more option
see JET-Line

Porte-outils avec écrou de serrage

Halter mit Spannmutter

Tool holders with clamping nut

BH6-D



> page 10.05

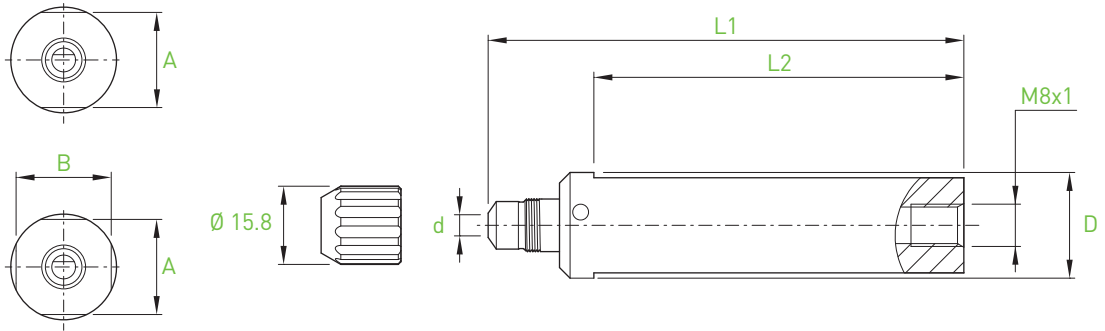

d	Bars	D	L1	L2	A x B	2 flats	4 flats	Art. N°
6	BB6... BF6...	12	75	55	11.2x11.2	■		BH6-D12-75
		12.7	75	55	11.2x11.2	■		BH6-D12.7-75
		15.87	75	55	14x14	■		BH6-D15.87-75
		16	75	55	14x14	■		BH6-D16-75
		19.05	90	70	17x17	■		BH6-D19.05-90
		20	90	70	18x18	■		BH6-D20-90
		20	90	70	18x18		■	BH6-D20-90-F4
		20	160	140	18x18		■	BH6-D20-160-F4
		22	90	70	20x20	■		BH6-D22-90
		22	90	70	20x20		■	BH6-D22-90-F4
		22	130	110	20x20		■	BH6-D22-130-F4
		25	100	80	23x23	■		BH6-D25-100
		25	100	80	23x23		■	BH6-D25-100-F4
		25	170	150	23x23		■	BH6-D25-170-F4
		25.4	100	80	23.4x23.4	■		BH6-D25.4-100
28	100	80	26x26	■		BH6-D28-100		

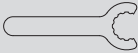
Pièces de rechange Ersatzteile Spare parts	 Art. N°	 Art. N°
BH6...	BH6-M12	C-BH6-M12

Option	 Art. N°
BH6...	J-M8X1-D6 <small>more option see JET-Line</small>

■ = disponible / verfügbar / available
□ = selon disponibilité du stock / jenach Lagerverfügbarkeit / depending the stock availability

Porte-outils avec arrosage multiple
 Halter mit mehrfaches Kühlungssystem
 Tool holders with multiple coolant system

BHS4-D

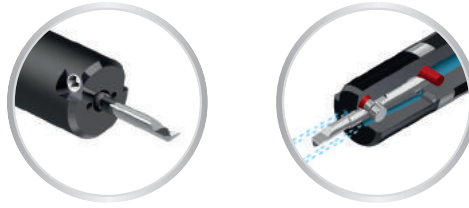

> page 10.05/10.07

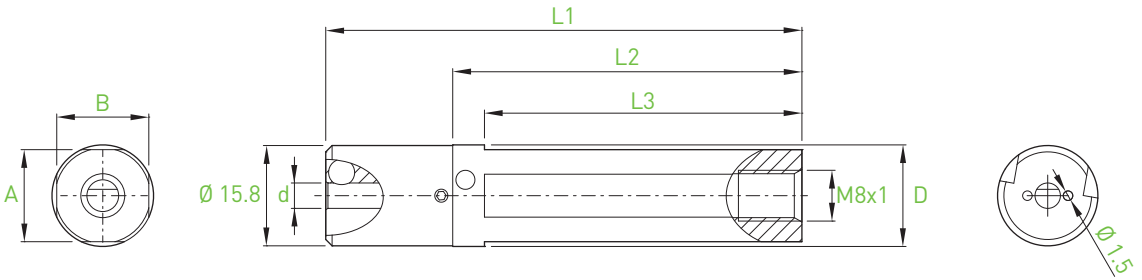

d	Bars	D	L1	L2	L3	A x B	Art. N°
4	BB4... BF4...	10	75	55	50	9.2x9.2	BHS4-D10-75-F4
		12	75	55	50	11x11	BHS4-D12-75-F4
		12.7	75	55	50	11.7x11.7	BHS4-D12.7-75-F4
		15.87	75	55	50	14.5x14.5	BHS4-D15.87-75-F4
		16	75	55	50	14.5x14.5	BHS4-D16-75-F4
		16	110	90	85	14.5x14.5	BHS4-D16-110-F4
		19.05	90	70	65	17x17	BHS4-D19.05-90-F4
		20	90	70	65	18x18	BHS4-D20-90-F4
		20	160	140	135	18x18	BHS4-D20-160-F4
		22	90	70	65	20x20	BHS4-D22-90-F4
		22	130	110	105	20x20	BHS4-D22-130-F4
		25	100	80	75	23x23	BHS4-D25-100-F4
		25	170	150	145	23x23	BHS4-D25-170-F4
		25.4	100	80	75	23x23	BHS4-D25.4-100-F4
28	100	80	75	26x26	BHS4-D28-100-F4		

Pièces de rechange
Ersatzteile
Spare parts

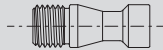

Art. N°

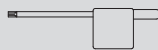

Art. N°

BHS4...

V-BHS-M4X0.5-T8

C-T8

Option

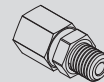

Art. N°



Art. N°

BHS4...

J-M8X1-D6

SET-NM1.2-TX8

more option
see JET-Line

Porte-outils avec arrosage multiple
 Halter mit mehrfaches Kühlungssystem
 Tool holders with multiple coolant system

BHS6-D

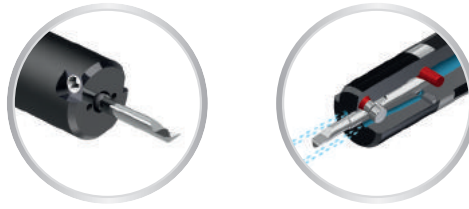

> page 10.05/10.07

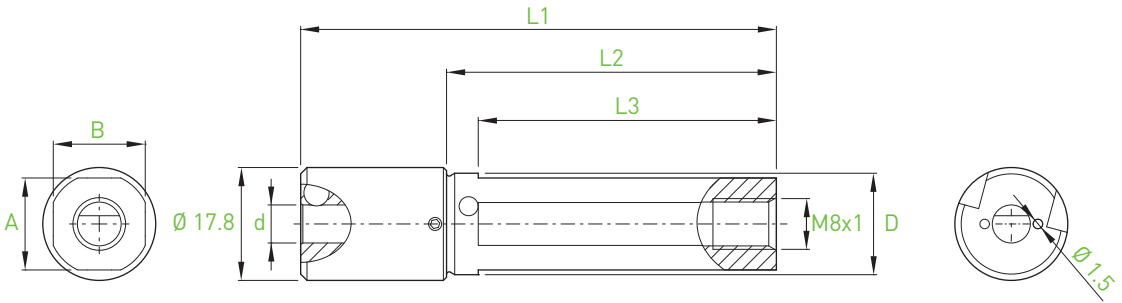

d	Bars	D	L1	L2	L3	A x B	Art. N°
6	BB6... BF6...	12	75	52	47	11x11	BHS6-D12-75-F4
		12.7	75	52	47	11.7x11.7	BHS6-D12.7-75-F4
		15.87	75	52	47	14.5x14.5	BHS6-D15.87-75-F4
		16	75	52	47	14.5x14.5	BHS6-D16-75-F4
		16	110	87	82	14.5x14.5	BHS6-D16-110-F4
		19.05	90	67	62	17x17	BHS6-D19.05-90-F4
		20	90	67	62	18x18	BHS6-D20-90-F4
		20	160	137	132	18x18	BHS6-D20-160-F4
		22	90	67	62	20x20	BHS6-D22-90-F4
		22	130	107	102	20x20	BHS6-D22-130-F4
		25	100	77	72	23x23	BHS6-D25-100-F4
		25	170	147	142	23x23	BHS6-D25-170-F4
		25.4	100	77	72	23x23	BHS6-D25.4-100-F4
28	100	77	72	26x26	BHS6-D28-100-F4		

Pièces de rechange
 Ersatzteile
 Spare parts

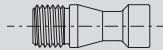

Art. N°

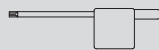

Art. N°

BHS6...

V-BHS-M4X0.5-T8

C-T8

Option

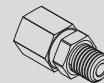

Art. N°



Art. N°

BHS6...

J-M8X1-D6

SET-NM1.2-TX8

more option
 see JET-Line

Porte-outils à serrage hydraulique
 Halter mit Hydro-Dehnspann-System
 Tool holders with hydraulic clamping system

BHY4-D



> page 10.06

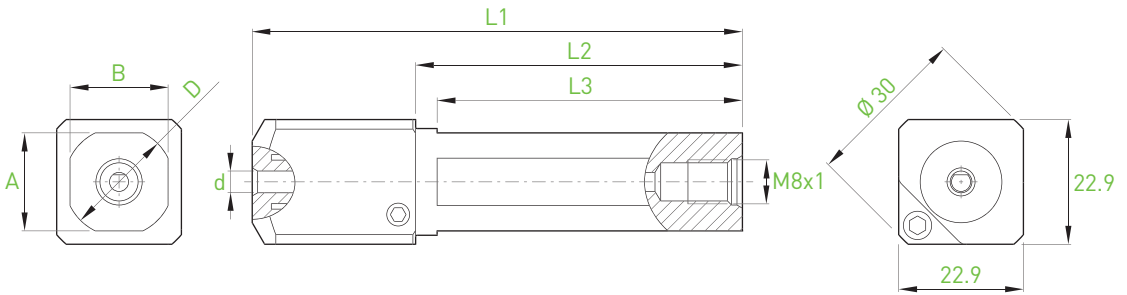

d	Bars	D	L1	L2	L3	A x B	Art. N°
4	BB4... BF4...	12	90	60	55	11.2x11.2	BHY4-D12-90-F4
		16	90	60	55	14.5x14.5	BHY4-D16-90-F4
		19.05	90	60	55	17x17	BHY4-D19.05-90-F4
		20	90	60	55	18x18	BHY4-D20-90-F4
		22	90	60	55	20x20	BHY4-D22-90-F4
		25	100	70	65	23x23	BHY4-D25-100-F4

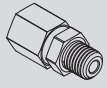
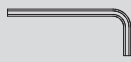
Pièces de rechange Ersatzteile Spare parts	 Art. N°	 Art. N°
BHY4...	J-M8X1-D6 more option see JET-Line	C-6P-3.0

Porte-outils à serrage hydraulique
 Halter mit Hydro-Dehnspann-System
 Tool holders with hydraulic clamping system

BHY6-D



> page 10.06

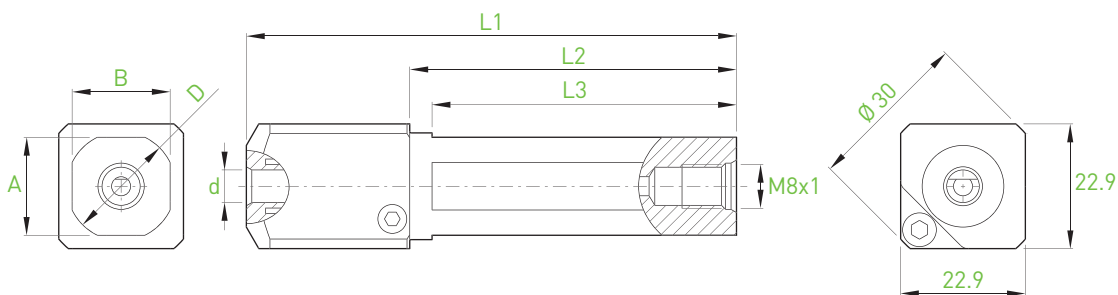

d	Bars	D	L1	L2	L3	A x B	Art. N°
6	BB6... BF6...	12	90	60	55	11.2x11.2	BHY6-D12-90-F4
		16	90	60	55	14.5x14.5	BHY6-D16-90-F4
		19.05	90	60	55	17x17	BHY6-D19.05-90-F4
		20	90	60	55	18x18	BHY6-D20-90-F4
		22	90	60	55	20x20	BHY6-D22-90-F4
		25	100	70	65	23x23	BHY6-D25-100-F4

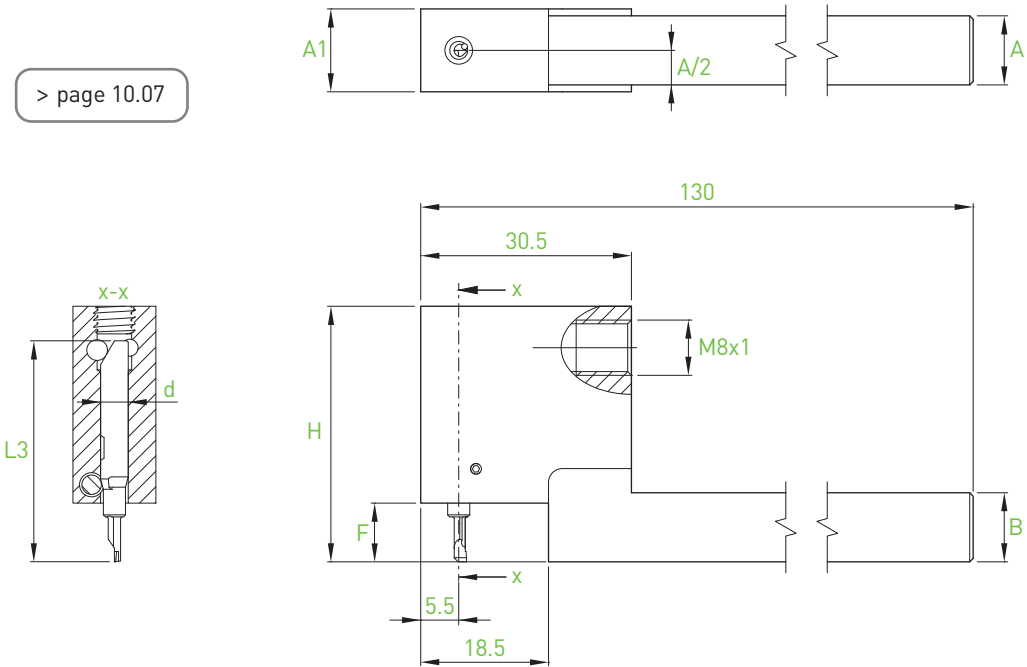

Pièces de rechange Ersatzteile Spare parts		
	Art. N°	Art. N°
BHY6...	J-M8X1-D6 more option see JET-Line	C-6P-3.0

> page 10.07

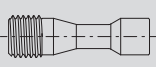
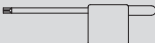

d	Bars	L3	A x B	F	H	A1	Art. N°
4	BB4R... BF4R...	32	8x8	8.5	37	12	BHK4N-0808X-32R
			10x10	8.5	37	12	BHK4N-1010X-32R
			12x12	8.5	37	12	BHK4N-1212X-32R
			16x16	8.5	37	16	BHK4N-1616X-32R
		37	8x8	13.5	42	12	BHK4N-0808X-37R
			10x10	13.5	42	12	BHK4N-1010X-37R
			12x12	13.5	42	12	BHK4N-1212X-37R
			16x16	13.5	42	16	BHK4N-1616X-37R
		42	10x10	18.5	47	12	BHK4N-1010X-42R
			12x12	18.5	47	12	BHK4N-1212X-42R
			16x16	18.5	47	16	BHK4N-1616X-42R

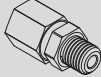
Pièces de rechange Ersatzteile Spare parts		
	Art. N°	Art. N°
BHK4N...	V-BHK-M4X0.5-T8	C-T8

Option		
	Art. N°	Art. N°
BHK4N...	J-M8X1-D6	SET-NM1.2-TX8
	more option see JET-Line	

Porte-outils coudés
 Kröpfhalter
 Cranked tool holders

BHK6N

> page 10.07

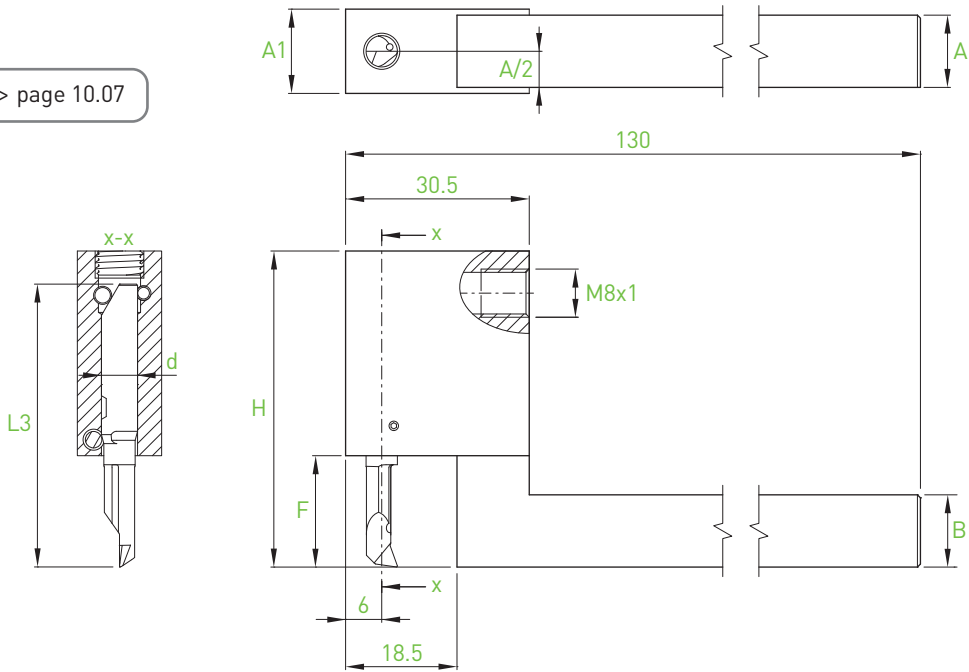

d	Bars	L3	A x B	F	H	A1	Art. N°
6	BB6R... BF6R...	47	10x10	18.5	52.5	12	BHK6N-1010X-47R
			12x12	18.5	52.5	12	BHK6N-1212X-47R
			16x16	18.5	52.5	16	BHK6N-1616X-47R
		57	10x10	28.5	62.5	12	BHK6N-1010X-57R
			12x12	28.5	62.5	12	BHK6N-1212X-57R
			16x16	28.5	62.5	16	BHK6N-1616X-57R

Pièces de rechange Ersatzteile Spare parts	Art. N°	Art. N°
BHK6N...	V-BHK-M4X0.5-T8	C-T8

Option	Art. N°	Art. N°
BHK6N...	J-M8X1-D6 <small>more option see JET-Line</small>	SET-NM1.2-TX8

IN-LINE

Porte-outils section carrée
 Viereckige Halter
 Square holders

BHS4

new

> page 10.07

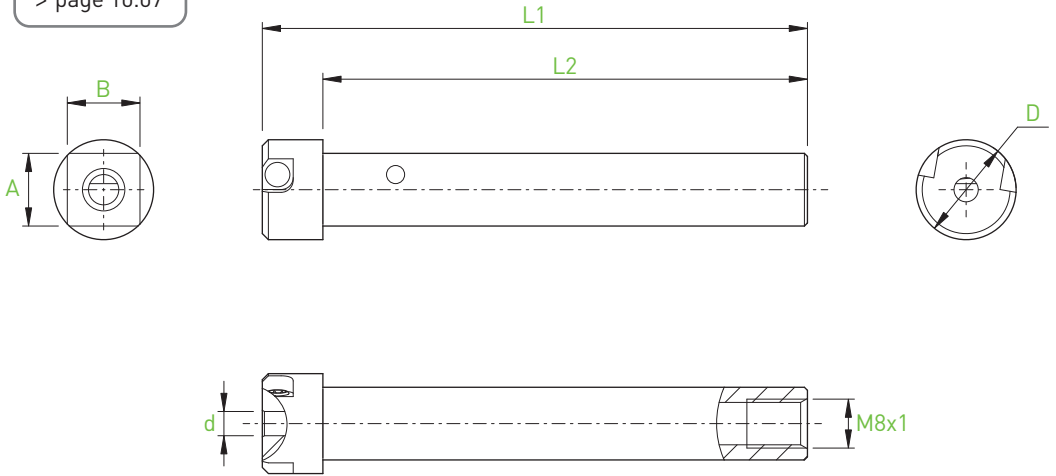

d	Bars	A x B	L1	L2	D	Art. N°
4	BB4... BF4...	12x12	90	80	16.5	BHS4-1212-90
		16x16	100	90	15.5	BHS4-1616-90

Pièces de rechange
 Ersatzteile
 Spare parts

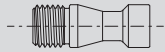

Art. N°

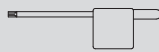

Art. N°

BHS4...

V-BHS-M4X0.5-T8

C-T8

Option

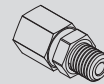

Art. N°



Art. N°

BHS4...

J-M8X1-D6

SET-NM1.2-TX8

more option
 see JET-Line

Porte-outils section carrée

Viereckige Halter

Square holders

BHS6

new

> page 10.05

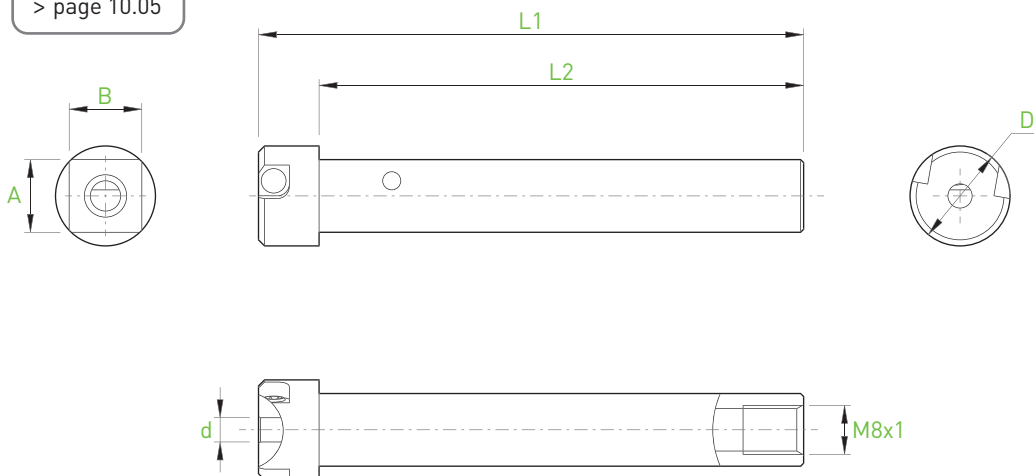

d	Bars	A x B	L1	L2	D	Art. N°
6	BB6... BF6...	12x12 16x16	90 100	80 -	17.5 -	BHS6-1212-90 BHS6-1616-90

Pièces de rechange
Ersatzteile
Spare parts

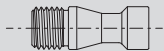

Art. N°

BHS6...

V-BHS-M4X0.5-T8

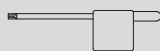

Art. N°

C-T8

Option

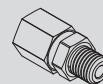

Art. N°

BHS6...

J-M8X1-D6

more option
see JET-Line



Art. N°

SET-NM1.2-TX8

IN-LINE

Alésage
Ausbohren
Boring

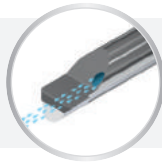

BB4...

BA

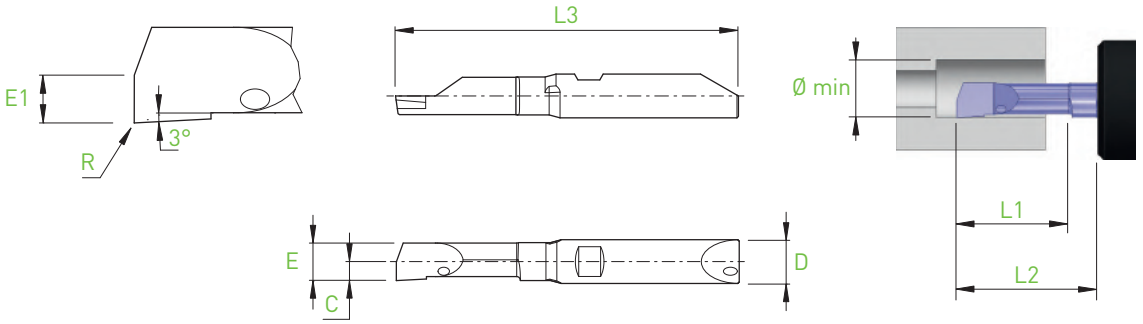

D h5	Holder	Ø min	L1	L2 BH4... BHY4...	L2 BHS4... BHK4...	E	E1	C	R	L3	Art. N°	R			L		
												ZTAF	ZTAXF	ZN	ZTAF	ZTAXF	ZN
4	BH4... BHS4... BHY4... BHK4...	0.3	0.9	10	8.5	0.27	0.13	0.15	0	32	BB4R/L-0309-BA	■	■	■	□	□	□
		0.4	1.2	10	8.5	0.36	0.18	0.20	0	32	BB4R/L-0412-BA	■	■	■	□	□	□
		0.5	1.5	10	8.5	0.45	0.22	0.25	0	32	BB4R/L-0515-BA	■	■	■	□	□	□
		0.6	1.8	10	8.5	0.54	0.27	0.30	0	32	BB4R/L-0618-BA	■	■	■	□	□	new
		0.7	2.1	10	8.5	0.63	0.31	0.35	0	32	BB4R/L-0721-BA	■	■	■	□	□	new
		0.8	2.4	10	8.5	0.72	0.36	0.40	0	32	BB4R/L-0824-BA	■	■	■	□	□	new
		0.9	2.7	10	8.5	0.81	0.40	0.45	0	32	BB4R/L-0927-BA	■	■	■	□	□	new
		1.0	3.0	10	8.5	0.90	0.45	0.60	0.02	32	BB4R/L-1030-BA-R02	■	■	■	□	□	
		1.2	3.6	10	8.5	1.08	0.54	0.60	0.02	32	BB4R/L-1236-BA-R02	■	■	■	□	□	new
		1.5	4.5	10	8.5	1.35	0.67	0.65	0.02	32	BB4R/L-1545-BA-R02	■	■	■	□	□	
		2.0	6.0	10	8.5	1.80	0.90	1.15	0.02	32	BB4R/L-2060-BA-R02	■	■	■	□	□	
		2.5	7.5	10	8.5	2.25	1.13	1.30	0.02	32	BB4R/L-2575-BA-R02	■	■	■	□	□	
		3.0	9.0	15	13.5	2.70	1.35	1.35	0.05	37	BB4R/L-3090-BA-R05	■	■	■	□	□	
3.5	10.5	15	13.5	3.15	1.58	1.60	0.05	37	BB4R/L-35105-BA-R05	■	■	■	□	□			

Alésage
Ausbohren
Boring



BF4...

BA

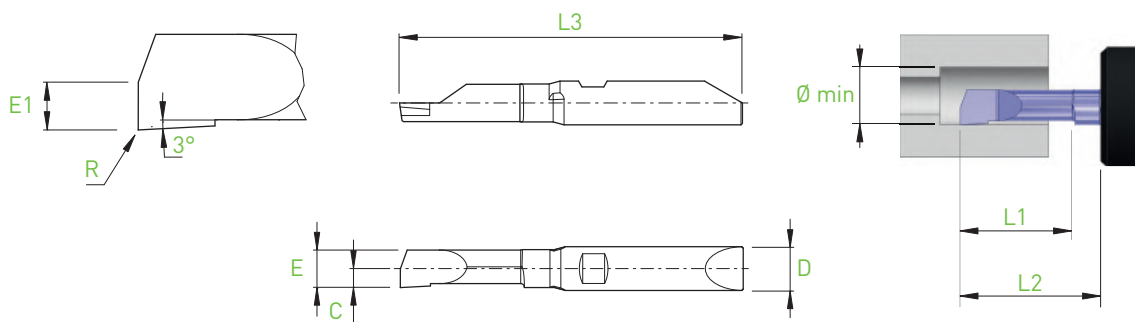

D h5	Holder	Ø min	L1	L2 BH4... BHY4...	L2 BHS4... BHK4...	E	E1	C	R	L3	Art. N°	R			L		
												ZTAF	ZTAXF	ZN	ZTAF	ZN	
4	BH4... BHS4... BHY4... BHK4...	0.3	0.9	10	8.5	0.27	0.13	0.15	0	32	BF4R/L-0309-BA	■	■	■	□	□	
		0.4	1.2	10	8.5	0.36	0.18	0.20	0	32	BF4R/L-0412-BA	■	■	■	□	□	
		0.5	1.5	10	8.5	0.45	0.22	0.25	0	32	BF4R/L-0515-BA	■	■	■	□	□	
		0.6	1.8	10	8.5	0.54	0.27	0.30	0	32	BF4R/L-0618-BA	■	■	■	□	□ new	
		0.7	2.1	10	8.5	0.63	0.31	0.35	0	32	BF4R/L-0721-BA	■	■	■	□	□ new	
		0.8	2.4	10	8.5	0.72	0.36	0.40	0	32	BF4R/L-0824-BA	■	■	■	□	□ new	
		0.9	2.7	10	8.5	0.81	0.40	0.45	0	32	BF4R/L-0927-BA	■	■	■	□	□ new	
		1.0	3.0	10	8.5	0.90	0.45	0.60	0.02	32	BF4R/L-1030-BA-R02	■	■	■	□	□	
		1.2	3.6	10	8.5	1.08	0.54	0.60	0.02	32	BF4R/L-1236-BA-R02	■	■	■	□	□ new	
		1.5	4.5	10	8.5	1.35	0.67	0.65	0.02	32	BF4R/L-1545-BA-R02	■	■	■	□	□	
		2.0	6.0	10	8.5	1.80	0.90	1.15	0.02	32	BF4R/L-2060-BA-R02	■	■	■	□	□	
		2.5	7.5	10	8.5	2.25	1.13	1.30	0.02	32	BF4R/L-2575-BA-R02	■	■	■	□	□	
		3.0	9.0	15	13.5	2.70	1.35	1.35	0.05	37	BF4R/L-3090-BA-R05	■	■	■	□	□	
3.5	10.5	15	13.5	3.15	1.58	1.60	0.05	37	BF4R/L-35105-BA-R05	■	■	■	□	□			

■ = disponible / verfügbar / available
□ = selon disponibilité du stock / jenach Lagerverfügbarkeit / depending the stock availability

IN-LINE

Alésage
Ausbohren
Boring

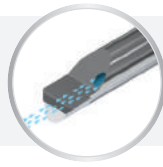

BB4... / BB6...

BAX

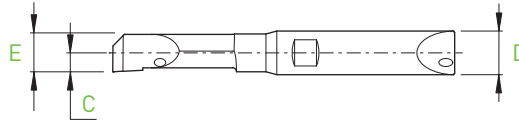
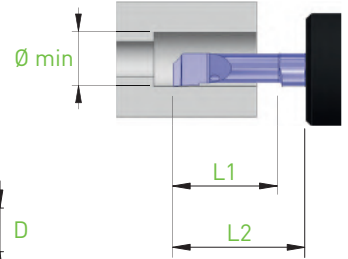
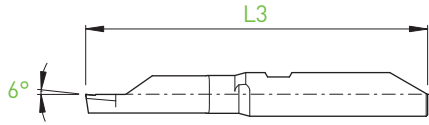
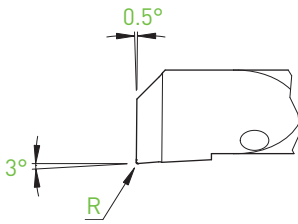

D _{h5}	Holder	Ø min	L1	L2 BH4... BHY4...	L2 BHS4... BHK4...	E	C	R	L3	Art. N°	R			L		
											ZTAF	ZTAXF	ZN	ZTAF	ZN	
4	BH4... BHS4... BHY4... BHK4...	0.5	1.5	10	8.5	0.45	0.25	0	32	BB4R/L-0515-BAX	■	■	■	□	□	
		0.6	1.8	10	8.5	0.54	0.30	0	32	BB4R/L-0618-BAX	■	■	■	□	□	
		0.7	2.1	10	8.5	0.63	0.35	0	32	BB4R/L-0721-BAX	■	■	■	□	□	
		0.8	2.4	10	8.5	0.72	0.40	0	32	BB4R/L-0824-BAX	■	■	■	□	□	
		0.9	2.7	10	8.5	0.81	0.45	0	32	BB4R/L-0927-BAX	■	■	■	□	□	
		1.0	3.0	10	8.5	0.90	0.60	0.02	32	BB4R/L-1030-BAX-R02	■	■	■	□	□	
			5.0	10	8.5	0.90	0.60	0.02	32	BB4R/L-1050-BAX-R02	■	■	■	□	□	
		1.5	4.5	10	8.5	1.35	0.65	0.02	32	BB4R/L-1545-BAX-R02	■	■	■	□	□	
			7.5	10	8.5	1.35	0.65	0.02	32	BB4R/L-1575-BAX-R02	■	■	■	□	□	
		2.0	6.0	10	8.5	1.80	1.15	0.02	32	BB4R/L-2060-BAX-R02	■	■	■	□	□	
			10.0	15	13.5	1.80	1.15	0.02	37	BB4R/L-20100-BAX-R02	■	■	■	□	□	
		2.5	7.5	10	8.5	2.25	1.30	0.05	32	BB4R/L-2575-BAX-R05	■	■	■	□	□	
			12.5	15	13.5	2.25	1.30	0.05	37	BB4R/L-25125-BAX-R05	■	■	■	□	□	
		3.0	9.0	15	13.5	2.70	1.35	0.05	37	BB4R/L-3090-BAX-R05	■	■	■	□	□	
			15.0	20	18.5	2.70	1.35	0.05	42	BB4R/L-30150-BAX-R05	■	■	■	□	□	
		3.5	10.5	15	13.5	3.15	1.60	0.05	37	BB4R/L-35105-BAX-R05	■	■	■	□	□	
17.5	20		18.5	3.15	1.60	0.05	42	BB4R/L-35175-BAX-R05	■	■	■	□	□			
6	BH6... BHS6... BHY6... BHK6...	4.0	12.0	20	18.5	3.80	2.20	0.05	47	BB6R/L-40120-BAX-R05	■	■	■	□	□	
			20.0	30	28.5	3.80	2.20	0.05	57	BB6R/L-40200-BAX-R05	■	■	■	□	□	
		4.5	13.5	20	18.5	4.28	2.30	0.05	47	BB6R/L-45135-BAX-R05	■	■	■	□	□	
			22.5	30	28.5	4.28	2.30	0.05	57	BB6R/L-45225-BAX-R05	■	■	■	□	□	
		5.0	15.0	20	18.5	4.75	2.40	0.05	47	BB6R/L-50150-BAX-R05	■	■	■	□	□	
			25.0	30	28.5	4.75	2.40	0.05	57	BB6R/L-50250-BAX-R05	■	■	■	□	□	
		5.5	16.5	20	18.5	5.15	2.60	0.05	47	BB6R/L-55165-BAX-R05	■	■	■	□	□	
			27.5	30	28.5	5.15	2.60	0.05	57	BB6R/L-55275-BAX-R05	■	■	■	□	□	

Alésage
Ausbohren
Boring



BF4... / BF6...

BAX

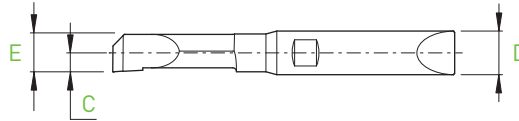
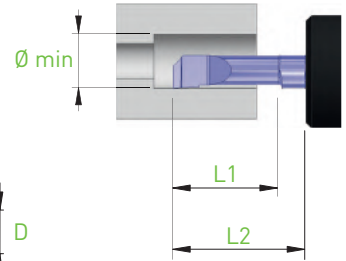
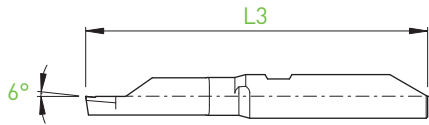
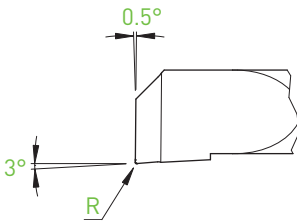

D h5	Holder	Ø min	L1	L2 BH4... BHY4...	L2 BHS4... BHK4...	E	C	R	L3	Art. N°	R			L		
											ZTAF	ZTAXF	ZN	ZTAF	ZN	
4	BH4... BHS4... BHY4... BHK4...	0.5	1.5	10	8.5	0.45	0.25	0	32	BF4R/L-0515-BAX	■	■	■	□	□	
		0.6	1.8	10	8.5	0.54	0.30	0	32	BF4R/L-0618-BAX	■	■	■	□	□	
		0.7	2.1	10	8.5	0.63	0.35	0	32	BF4R/L-0721-BAX	■	■	■	□	□	
		0.8	2.4	10	8.5	0.72	0.40	0	32	BF4R/L-0824-BAX	■	■	■	□	□	
		0.9	2.7	10	8.5	0.81	0.45	0	32	BF4R/L-0927-BAX	■	■	■	□	□	
		1.0	3.0	10	8.5	0.90	0.60	0.02	32	BF4R/L-1030-BAX-R02	■	■	■	□	□	
			5.0	10	8.5	0.90	0.60	0.02	32	BF4R/L-1050-BAX-R02	■	■	■	□	□	
		1.5	4.5	10	8.5	1.35	0.65	0.02	32	BF4R/L-1545-BAX-R02	■	■	■	□	□	
			7.5	10	8.5	1.35	0.65	0.02	32	BF4R/L-1575-BAX-R02	■	■	■	□	□	
		2.0	6.0	10	8.5	1.80	1.15	0.02	32	BF4R/L-2060-BAX-R02	■	■	■	□	□	
			10.0	15	13.5	1.80	1.15	0.02	37	BF4R/L-20100-BAX-R02	■	■	■	□	□	
		2.5	7.5	10	8.5	2.25	1.30	0.05	32	BF4R/L-2575-BAX-R05	■	■	■	□	□	
			12.5	15	13.5	2.25	1.30	0.05	37	BF4R/L-25125-BAX-R05	■	■	■	□	□	
		3.0	9.0	15	13.5	2.70	1.35	0.05	37	BF4R/L-3090-BAX-R05	■	■	■	□	□	
			15.0	20	18.5	2.70	1.35	0.05	42	BF4R/L-30150-BAX-R05	■	■	■	□	□	
		3.5	10.5	15	13.5	3.15	1.60	0.05	37	BF4R/L-35105-BAX-R05	■	■	■	□	□	
17.5	20		18.5	3.15	1.60	0.05	42	BF4R/L-35175-BAX-R05	■	■	■	□	□			

D h5	Holder	Ø min	L1	L2 BH6... BHY6...	L2 BHS6... BHK6...	E	C	R	L3	Art. N°	ZTAF	ZTAXF	ZN	ZTAF	ZN
											■	■	■	■	■
6	BH6... BHS6... BHY6... BHK6...	4.0	12.0	20	18.5	3.80	2.20	0.05	47	BF6R/L-40120-BAX-R05	■	■	■	□	□
			20.0	30	28.5	3.80	2.20	0.05	57	BF6R/L-40200-BAX-R05	■	■	■	□	□
		4.5	13.5	20	18.5	4.28	2.30	0.05	47	BF6R/L-45135-BAX-R05	■	■	■	□	□
			22.5	30	28.5	4.28	2.30	0.05	57	BF6R/L-45225-BAX-R05	■	■	■	□	□
		5.0	15.0	20	18.5	4.75	2.40	0.05	47	BF6R/L-50150-BAX-R05	■	■	■	□	□
			25.0	30	28.5	4.75	2.40	0.05	57	BF6R/L-50250-BAX-R05	■	■	■	□	□
		5.5	16.5	20	18.5	5.15	2.60	0.05	47	BF6R/L-55165-BAX-R05	■	■	■	□	□
			27.5	30	28.5	5.15	2.60	0.05	57	BF6R/L-55275-BAX-R05	■	■	■	□	□

■ = disponible / verfügbar / available
□ = selon disponibilité du stock / jenach Lagerverfügbarkeit / depending the stock availability

IN-LINE

- Alésage-copiage
- Ausbohren-kopieren
- Boring chamfering

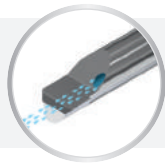

BB4... / BB6...

BCX

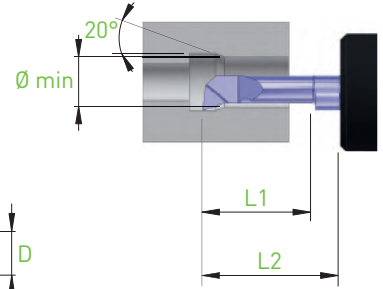
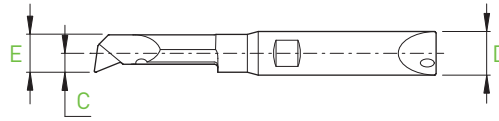
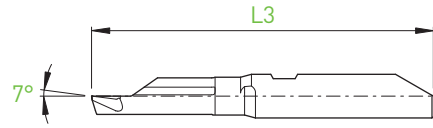
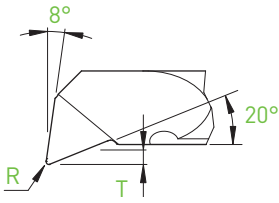

D h5	Holder	Ø min	L1	L2 BH4... BHY4...	L2 BHS4... BHK4...	T	E	C	R	L3	Art. N°	R		L				
												ZTAF	ZTAXF	ZN	ZTAF	ZN		
4	BH4... BHS4... BHY4... BHK4...	1.0	3.0	10	8.5	0.15	0.90	0.70	0.05	32	BB4R/L-1030-BCX-R05	■	■	■	□	□		
			5.0	10	8.5	0.15	0.90	0.70	0.05	32	BB4R/L-1050-BCX-R05	■	■	■	□	□		
		1.5	4.5	10	8.5	0.23	1.35	0.75	0.05	32	BB4R/L-1545-BCX-R05	■	■	■	□	□		
			7.5	10	8.5	0.23	1.35	0.75	0.05	32	BB4R/L-1575-BCX-R05	■	■	■	□	□		
		2.0	6.0	10	8.5	0.30	1.80	1.15	0.05	32	BB4R/L-2060-BCX-R05	■	■	■	□	□		
			10.0	15	13.5	0.30	1.80	1.15	0.05	37	BB4R/L-20100-BCX-R05	■	■	■	□	□		
		2.5	7.5	10	8.5	0.38	2.25	1.30	0.10	32	BB4R/L-2575-BCX-R10	■	■	■	□	□		
			12.5	15	13.5	0.38	2.25	1.30	0.10	37	BB4R/L-25125-BCX-R10	■	■	■	□	□		
		3.0	9.0	15	13.5	0.45	2.70	1.35	0.10	37	BB4R/L-3090-BCX-R10	■	■	■	□	□		
			15.0	20	18.5	0.45	2.70	1.35	0.10	42	BB4R/L-30150-BCX-R10	■	■	■	□	□		
		3.5	10.5	15	13.5	0.53	3.15	1.60	0.10	37	BB4R/L-35105-BCX-R10	■	■	■	□	□		
			17.5	20	18.5	0.53	3.15	1.60	0.10	42	BB4R/L-35175-BCX-R10	■	■	■	□	□		
		D h5	Holder	Ø min	L1	L2 BH6... BHY6...	L2 BHS6... BHK6...	T	E	C	R	L3	Art. N°	ZTAF	ZTAXF	ZN	ZTAF	ZN
		6	BH6... BHS6... BHY6... BHK6...	4.0	12.0	20	18.5	0.60	3.80	2.20	0.15	47	BB6R/L-40120-BCX-R15	■	■	■	□	□
20.0	30				28.5	0.60	3.80	2.20	0.15	57	BB6R/L-40200-BCX-R15	■	■	■	□	□		
4.5	13.5			20	18.5	0.68	4.28	2.30	0.15	47	BB6R/L-45135-BCX-R15	■	■	■	□	□		
	22.5			30	28.5	0.68	4.28	2.30	0.15	57	BB6R/L-45225-BCX-R15	■	■	■	□	□		
5.0	15.0			20	18.5	0.75	4.75	2.40	0.15	47	BB6R/L-50150-BCX-R15	■	■	■	□	□		
	25.0			30	28.5	0.75	4.75	2.40	0.15	57	BB6R/L-50250-BCX-R15	■	■	■	□	□		
5.5	16.5			20	18.5	0.83	5.15	2.60	0.15	47	BB6R/L-55165-BCX-R15	■	■	■	□	□		
	27.5			30	28.5	0.83	5.15	2.60	0.15	57	BB6R/L-55275-BCX-R15	■	■	■	□	□		

Alésage-copiage
 Ausbohren-kopieren
 Boring chambering

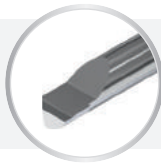

BF4... / BF6...

BCX

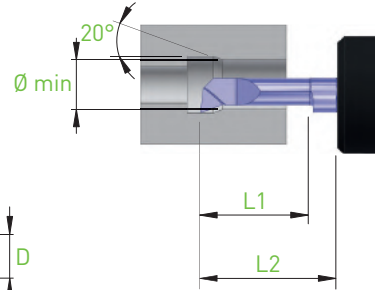
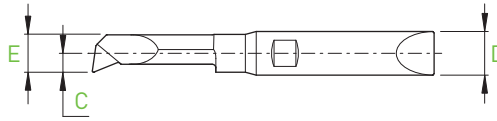
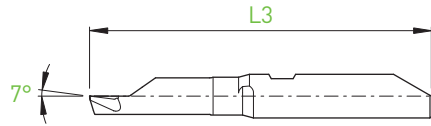
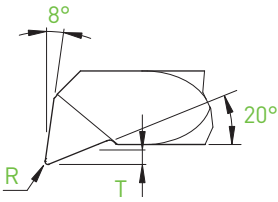

D h5	Holder	Ø min	L1	L2 BH4... BHY4...	L2 BHS4... BHK4...	T	E	C	R	L3	Art. N°	R		L		
												ZTAF	ZTAXF	ZN	ZTAF	ZN
4	BH4... BHS4... BHY4... BHK4...	1.0	3.0	10	8.5	0.15	0.90	0.70	0.05	32	BF4R/L-1030-BCX-R05	■	■	■	□	□
			5.0	10	8.5	0.15	0.90	0.70	0.05	32	BF4R/L-1050-BCX-R05	■	■	■	□	□
		1.5	4.5	10	8.5	0.23	1.35	0.75	0.05	32	BF4R/L-1545-BCX-R05	■	■	■	□	□
			7.5	10	8.5	0.23	1.35	0.75	0.05	32	BF4R/L-1575-BCX-R05	■	■	■	□	□
		2.0	6.0	10	8.5	0.30	1.80	1.15	0.05	32	BF4R/L-2060-BCX-R05	■	■	■	□	□
			10.0	15	13.5	0.30	1.80	1.15	0.05	37	BF4R/L-20100-BCX-R05	■	■	■	□	□
		2.5	7.5	10	8.5	0.38	2.25	1.30	0.10	32	BF4R/L-2575-BCX-R10	■	■	■	□	□
			12.5	15	13.5	0.38	2.25	1.30	0.10	37	BF4R/L-25125-BCX-R10	■	■	■	□	□
		3.0	9.0	15	13.5	0.45	2.70	1.35	0.10	37	BF4R/L-3090-BCX-R10	■	■	■	□	□
			15.0	20	18.5	0.45	2.70	1.35	0.10	42	BF4R/L-30150-BCX-R10	■	■	■	□	□
		3.5	10.5	15	13.5	0.53	3.15	1.60	0.10	37	BF4R/L-35105-BCX-R10	■	■	■	□	□
			17.5	20	18.5	0.53	3.15	1.60	0.10	42	BF4R/L-35175-BCX-R10	■	■	■	□	□
D h5	Holder	Ø min	L1	L2 BH6... BHY6...	L2 BHS6... BHK6...	T	E	C	R	L3	Art. N°	ZTAF	ZTAXF	ZN	ZTAF	ZN
6	BH6... BHS6... BHY6... BHK6...	4.0	12.0	20	18.5	0.60	3.80	2.20	0.15	47	BF6R/L-40120-BCX-R15	■	■	■	□	□
			20.0	30	28.5	0.60	3.80	2.20	0.15	57	BF6R/L-40200-BCX-R15	■	■	■	□	□
		4.5	13.5	20	18.5	0.68	4.28	2.30	0.15	47	BF6R/L-45135-BCX-R15	■	■	■	□	□
			22.5	30	28.5	0.68	4.28	2.30	0.15	57	BF6R/L-45225-BCX-R15	■	■	■	□	□
		5.0	15.0	20	18.5	0.75	4.75	2.40	0.15	47	BF6R/L-50150-BCX-R15	■	■	■	□	□
			25.0	30	28.5	0.75	4.75	2.40	0.15	57	BF6R/L-50250-BCX-R15	■	■	■	□	□
		5.5	16.5	20	18.5	0.83	5.15	2.60	0.15	47	BF6R/L-55165-BCX-R15	■	■	■	□	□
			27.5	30	28.5	0.83	5.15	2.60	0.15	57	BF6R/L-55275-BCX-R15	■	■	■	□	□

■ = disponible / verfügbar / available
 □ = selon disponibilité du stock / jenach Lagerverfügbarkeit / depending the stock availability

Copiage
Kopieren
Chamfering

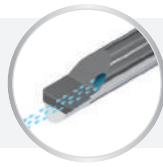

BB4... / BB6...

C45

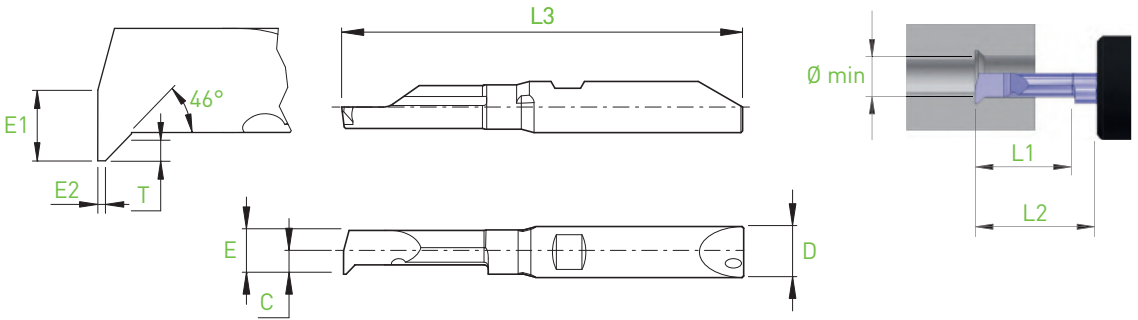

D h5	Holder	Ø min	L1	L2 BH4... BHY4...	L2 BHS4... BHK4...	T	E	E1	C	E2	L3	Art. N°	R		L	
													ZTAF	ZTAXF	ZN	ZTAF
4	BH4... BHS4... BHY4... BHK4...	0.3	0.6	10	8.5	0.05	0.27	0.13	0.15	0.03	32	BB4R/L-0306-C45-E03	<input type="checkbox"/>	<input type="checkbox"/>	<input type="checkbox"/>	<input type="checkbox"/>
		0.4	0.8	10	8.5	0.07	0.36	0.18	0.20	0.03	32	BB4R/L-0408-C45-E03	<input type="checkbox"/>	<input type="checkbox"/>	<input type="checkbox"/>	<input type="checkbox"/>
		0.5	1.0	10	8.5	0.08	0.45	0.22	0.25	0.03	32	BB4R/L-0510-C45-E03	<input type="checkbox"/>	<input type="checkbox"/>	<input type="checkbox"/>	<input type="checkbox"/>
		0.6	1.2	10	8.5	0.10	0.54	0.27	0.30	0.03	32	BB4R/L-0612-C45-E03	<input type="checkbox"/>	<input type="checkbox"/>	<input type="checkbox"/>	<input type="checkbox"/>
		0.7	1.2	10	8.5	0.12	0.63	0.32	0.35	0.03	32	BB4R/L-0714-C45-E03	<input type="checkbox"/>	<input type="checkbox"/>	<input type="checkbox"/>	<input type="checkbox"/>
		0.8	1.6	10	8.5	0.14	0.72	0.36	0.40	0.05	32	BB4R/L-0816-C45-E05	<input type="checkbox"/>	<input type="checkbox"/>	<input type="checkbox"/>	<input type="checkbox"/>
		0.9	1.8	10	8.5	0.15	0.81	0.41	0.45	0.05	32	BB4R/L-0918-C45-E05	<input type="checkbox"/>	<input type="checkbox"/>	<input type="checkbox"/>	<input type="checkbox"/>
		1.0	3.0	10	8.5	0.17	0.90	0.45	0.70	0.10	32	BB4R/L-1030-C45-E10	<input type="checkbox"/>	<input type="checkbox"/>	<input type="checkbox"/>	<input type="checkbox"/>
		1.2	3.6	10	8.5	0.20	1.08	0.54	0.70	0.10	32	BB4R/L-1236-C45-E10	<input type="checkbox"/>	<input type="checkbox"/>	<input type="checkbox"/>	<input type="checkbox"/>
		1.5	4.5	10	8.5	0.25	1.35	0.67	0.75	0.10	32	BB4R/L-1545-C45-E10	<input type="checkbox"/>	<input type="checkbox"/>	<input type="checkbox"/>	<input type="checkbox"/>
		2.0	6.0	10	8.5	0.34	1.80	0.90	1.15	0.20	32	BB4R/L-2060-C45-E20	<input type="checkbox"/>	<input type="checkbox"/>	<input type="checkbox"/>	<input type="checkbox"/>
		2.5	7.5	10	8.5	0.43	2.25	1.13	1.30	0.20	32	BB4R/L-2575-C45-E20	<input type="checkbox"/>	<input type="checkbox"/>	<input type="checkbox"/>	<input type="checkbox"/>
3.0	9.0	15	13.5	0.51	2.70	1.35	1.35	0.30	37	BB4R/L-3090-C45-E30	<input type="checkbox"/>	<input type="checkbox"/>	<input type="checkbox"/>	<input type="checkbox"/>		
3.5	10.5	15	13.5	0.60	3.15	1.58	1.60	0.30	37	BB4R/L-35105-C45-E30	<input type="checkbox"/>	<input type="checkbox"/>	<input type="checkbox"/>	<input type="checkbox"/>		
6	BH6... BHS6... BHY6... BHK6...	4.0	12.0	20	18.5	0.68	3.80	1.90	2.30	0.40	47	BB6R/L-40120-C45-E40	<input type="checkbox"/>	<input type="checkbox"/>	<input type="checkbox"/>	<input type="checkbox"/>
		5.0	15.0	20	18.5	0.85	4.75	2.37	2.50	0.50	47	BB6R/L-50150-C45-E50	<input type="checkbox"/>	<input type="checkbox"/>	<input type="checkbox"/>	<input type="checkbox"/>

new

- Copiage
- Kopieren
- Chambering



BF4... / BF6...

C45

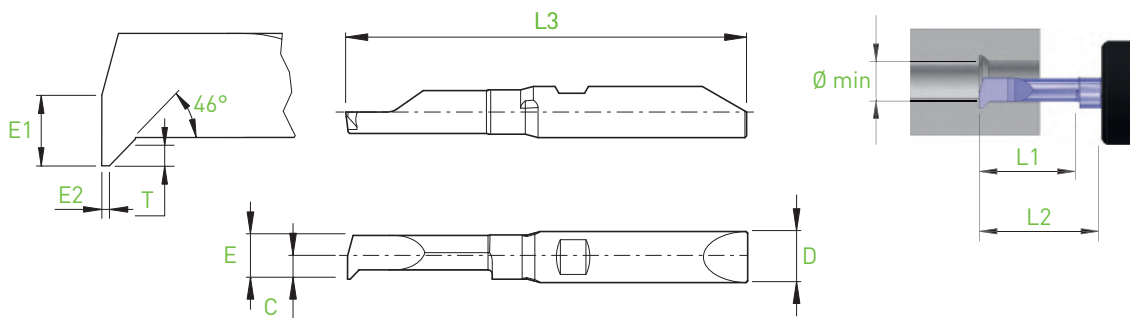

D h5	Holder	Ø min	L1	L2 BH4... BHY4...	L2 BHS4... BHK4...	T	E	E1	C	E2	L3	Art. N°	R		L		
													ZTAF	ZTAXF	ZN	ZTAF	ZN
4	BH4... BHS4... BHY4... BHK4...	0.3	0.6	10	8.5	0.05	0.27	0.13	0.15	0.03	32	BF4R/L-0306-C45-E03	■	■	■	□	□
		0.4	0.8	10	8.5	0.07	0.36	0.18	0.20	0.03	32	BF4R/L-0408-C45-E03	■	■	■	□	□
		0.5	1.0	10	8.5	0.08	0.45	0.22	0.25	0.03	32	BF4R/L-0510-C45-E03	■	■	■	□	□
		0.6	1.2	10	8.5	0.10	0.54	0.27	0.30	0.03	32	BF4R/L-0612-C45-E03	■	■	■	□	□
		0.7	1.2	10	8.5	0.12	0.63	0.32	0.35	0.03	32	BF4R/L-0714-C45-E03	■	■	■	□	□
		0.8	1.6	10	8.5	0.14	0.72	0.36	0.40	0.05	32	BF4R/L-0816-C45-E05	■	■	■	□	□
		0.9	1.8	10	8.5	0.15	0.81	0.41	0.45	0.05	32	BF4R/L-0918-C45-E05	■	■	■	□	□
		1.0	3.0	10	8.5	0.17	0.90	0.45	0.70	0.10	32	BF4R/L-1030-C45-E10	■	■	■	□	□
		1.2	3.6	10	8.5	0.20	1.08	0.54	0.70	0.10	32	BF4R/L-1236-C45-E10	■	■	■	□	□
		1.5	4.5	10	8.5	0.25	1.35	0.67	0.75	0.10	32	BF4R/L-1545-C45-E10	■	■	■	□	□
		2.0	6.0	10	8.5	0.34	1.80	0.90	1.15	0.20	32	BF4R/L-2060-C45-E20	■	■	■	□	□
		2.5	7.5	10	8.5	0.43	2.25	1.13	1.30	0.20	32	BF4R/L-2575-C45-E20	■	■	■	□	□
3.0	9.0	15	13.5	0.51	2.70	1.35	1.35	0.30	37	BF4R/L-3090-C45-E30	■	■	■	□	□		
3.5	10.5	15	13.5	0.60	3.15	1.58	1.60	0.30	37	BF4R/L-35105-C45-E30	■	■	■	□	□		
6	BH6... BHS6... BHY6... BHK6...	4.0	12.0	20	18.5	0.68	3.80	1.90	2.30	0.40	47	BF6R/L-40120-C45-E40	■	■	■	□	□
		5.0	15.0	20	18.5	0.85	4.75	2.37	2.50	0.50	47	BF6R/L-50150-C45-E50	■	■	■	□	□

■ = disponible / verfügbar / available
□ = selon disponibilité du stock / jenach Lagerverfügbarkeit / depending the stock availability

Copiage
Kopieren
Chamfering

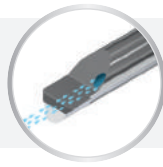

BB4... / BB6...

C45X

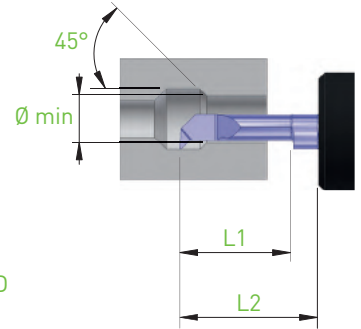
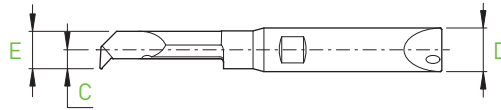
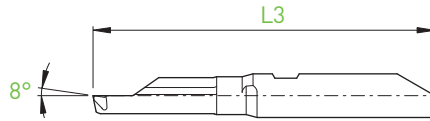
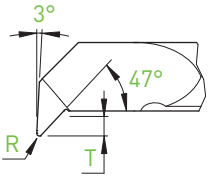

D _{h5}	Holder	Ø min	L1	L2 BH4... BHY4...	L2 BHS4... BHK4...	T	E	C	R	L3	Art. N°	R		L	
												ZTAF	ZTAXF	ZN	ZTAF
4	BH4... BHS4... BHY4... BHK4...	2.5	7.5	10	8.5	0.50	2.25	1.35	0.10	32	BB4R/L-2575-C45X-R10	<input checked="" type="checkbox"/>	<input checked="" type="checkbox"/>	<input type="checkbox"/>	<input type="checkbox"/>
			12.5	15	13.5	0.50	2.25	1.35	0.10	37	BB4R/L-25125-C45X-R10	<input checked="" type="checkbox"/>	<input checked="" type="checkbox"/>	<input type="checkbox"/>	<input type="checkbox"/>
		3.0	9.0	15	13.5	0.60	2.70	1.45	0.10	37	BB4R/L-3090-C45X-R10	<input checked="" type="checkbox"/>	<input checked="" type="checkbox"/>	<input type="checkbox"/>	<input type="checkbox"/>
			15.0	20	18.5	0.60	2.70	1.45	0.10	42	BB4R/L-30150-C45X-R10	<input checked="" type="checkbox"/>	<input checked="" type="checkbox"/>	<input type="checkbox"/>	<input type="checkbox"/>
		3.5	10.5	15	13.5	0.70	3.15	1.60	0.10	37	BB4R/L-35105-C45X-R10	<input checked="" type="checkbox"/>	<input checked="" type="checkbox"/>	<input type="checkbox"/>	<input type="checkbox"/>
			17.5	20	18.5	0.70	3.15	1.60	0.10	42	BB4R/L-35175-C45X-R10	<input checked="" type="checkbox"/>	<input checked="" type="checkbox"/>	<input type="checkbox"/>	<input type="checkbox"/>
6	BH6... BHS6... BHY6... BHK6...	4.0	12.0	20	18.5	0.80	3.80	2.30	0.15	47	BB6R/L-40120-C45X-R15	<input checked="" type="checkbox"/>	<input checked="" type="checkbox"/>	<input type="checkbox"/>	<input type="checkbox"/>
			20.0	30	28.5	0.80	3.80	2.30	0.15	57	BB6R/L-40200-C45X-R15	<input checked="" type="checkbox"/>	<input checked="" type="checkbox"/>	<input type="checkbox"/>	<input type="checkbox"/>
		4.5	13.5	20	18.5	0.90	4.28	2.40	0.15	47	BB6R/L-45135-C45X-R15	<input checked="" type="checkbox"/>	<input checked="" type="checkbox"/>	<input type="checkbox"/>	<input type="checkbox"/>
			22.5	30	28.5	0.90	4.28	2.40	0.15	57	BB6R/L-45225-C45X-R15	<input checked="" type="checkbox"/>	<input checked="" type="checkbox"/>	<input type="checkbox"/>	<input type="checkbox"/>
		5.0	15.0	20	18.5	1.00	4.75	2.50	0.15	47	BB6R/L-50150-C45X-R15	<input checked="" type="checkbox"/>	<input checked="" type="checkbox"/>	<input type="checkbox"/>	<input type="checkbox"/>
			25.0	30	28.5	1.00	4.75	2.50	0.15	57	BB6R/L-50250-C45X-R15	<input checked="" type="checkbox"/>	<input checked="" type="checkbox"/>	<input type="checkbox"/>	<input type="checkbox"/>
		5.5	16.5	20	18.5	1.10	5.15	2.60	0.15	47	BB6R/L-55165-C45X-R15	<input checked="" type="checkbox"/>	<input checked="" type="checkbox"/>	<input type="checkbox"/>	<input type="checkbox"/>
			27.5	30	28.5	1.10	5.15	2.60	0.15	57	BB6R/L-55275-C45X-R15	<input checked="" type="checkbox"/>	<input checked="" type="checkbox"/>	<input type="checkbox"/>	<input type="checkbox"/>

Copiage
Kopieren
Chambering

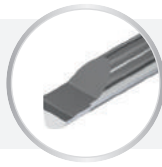

BF4... / BF6...

C45X

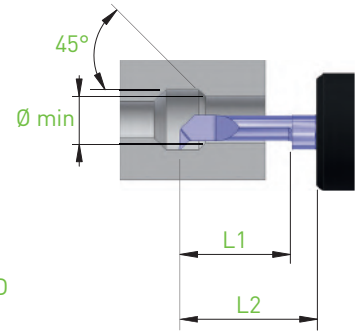
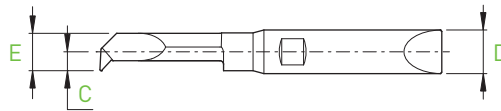
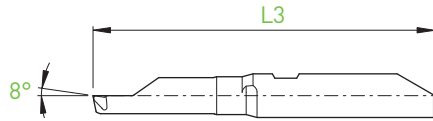
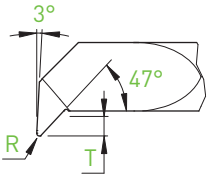

D _{h5}	Holder	Ø min	L1	L2 BH4... BHY4...	L2 BHS4... BHK4...	T	E	C	R	L3	Art. N°	R		L		
												ZTAF	ZTAXF	ZN	ZTAF	ZN
4	BH4... BHS4... BHY4... BHK4...	2.5	7.5	10	8.5	0.50	2.25	1.35	0.10	32	BF4R/L-2575-C45X-R10	■	■	■	□	□
			12.5	15	13.5	0.50	2.25	1.35	0.10	37	BF4R/L-25125-C45X-R10	■	■	■	□	□
		3.0	9.0	15	13.5	0.60	2.70	1.45	0.10	37	BF4R/L-3090-C45X-R10	■	■	■	□	□
			15.0	20	18.5	0.60	2.70	1.45	0.10	42	BF4R/L-30150-C45X-R10	■	■	■	□	□
		3.5	10.5	15	13.5	0.70	3.15	1.60	0.10	37	BF4R/L-35105-C45X-R10	■	■	■	□	□
			17.5	20	18.5	0.70	3.15	1.60	0.10	42	BF4R/L-35175-C45X-R10	■	■	■	□	□
D _{h5}	Holder	Ø min	L1	L2 BH6... BHY6...	L2 BHS6... BHK6...	T	E	C	R	L3	Art. N°	ZTAF	ZTAXF	ZN	ZTAF	ZN
6	BH6... BHS6... BHY6... BHK6...	4.0	12.0	20	18.5	0.80	3.80	2.30	0.15	47	BF6R/L-40120-C45X-R15	■	■	■	□	□
			20.0	30	28.5	0.80	3.80	2.30	0.15	57	BF6R/L-40200-C45X-R15	■	■	■	□	□
		4.5	13.5	20	18.5	0.90	4.28	2.40	0.15	47	BF6R/L-45135-C45X-R15	■	■	■	□	□
			22.5	30	28.5	0.90	4.28	2.40	0.15	57	BF6R/L-45225-C45X-R15	■	■	■	□	□
		5.0	15.0	20	18.5	1.00	4.75	2.50	0.15	47	BF6R/L-50150-C45X-R15	■	■	■	□	□
			25.0	30	28.5	1.00	4.75	2.50	0.15	57	BF6R/L-50250-C45X-R15	■	■	■	□	□
		5.5	16.5	20	18.5	1.10	5.15	2.60	0.15	47	BF6R/L-55165-C45X-R15	■	■	■	□	□
			27.5	30	28.5	1.10	5.15	2.60	0.15	57	BF6R/L-55275-C45X-R15	■	■	■	□	□

IN-LINE

Gorge
Einstecken
Grooving

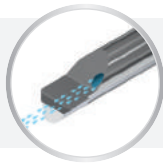

BB4... / BB6...

GX

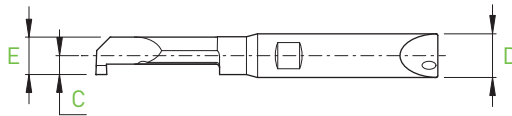
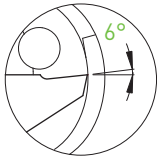
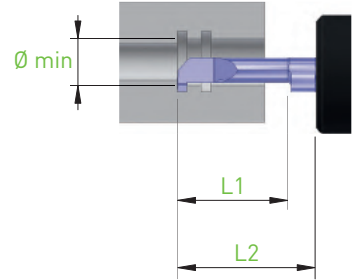
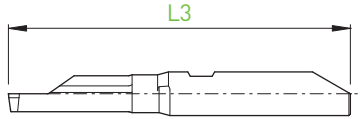
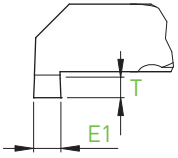

D _{h5}	Holder	Ø min	L1	L2 BH4... BHY4...	L2 BHS4... BHK4...	E1	T	E	C	L3	Art. N°	R			L				
												ZTAF	ZTAXF	ZN	ZTAF	ZN	ZN		
4	BH4... BHS4... BHY4... BHK4...	3.0	9.0	15	13.5	0.50	0.60	2.70	1.45	37	BB4R/L-3090-G050X	■	■	■	□	□	□		
			15.0	20	18.5	0.50	0.60	2.70	1.45	42	BB4R/L-30150-G050X	■	■	■	□	□	□		
		3.5	10.5	15	13.5	0.75	0.70	3.15	1.60	37	BB4R/L-35105-G075X	■	■	■	□	□	□		
			17.5	20	18.5	0.75	0.70	3.15	1.60	42	BB4R/L-35175-G075X	■	■	■	□	□	□		
6	BH6... BHS6... BHY6... BHK6...	4.0	12.0	20	18.5	1.00	0.80	3.80	2.20	47	BB6R/L-40120-G100X	■	■	■	□	□	□		
			20.0	30	28.5	1.00	0.80	3.80	2.20	57	BB6R/L-40200-G100X	■	■	■	□	□	□		
			4.5	13.5	20	18.5	1.00 1.50	0.90	4.28	2.40	47	BB6R/L-45135-G100X BB6R/L-45135-G150X	■	■	■	□	□	□	
				22.5	30	28.5	1.00 1.50	0.90	4.28	2.40	57	BB6R/L-45225-G100X BB6R/L-45225-G150X	■	■	■	□	□	□	
		5.0	15.0	15.0	20	18.5	1.00 1.50	1.00	4.75	2.50	47	BB6R/L-50150-G100X BB6R/L-50150-G150X	■	■	■	□	□	□	
				25.0	30	28.5	1.00 1.50	1.00	4.75	2.50	57	BB6R/L-50250-G100X BB6R/L-50250-G150X	■	■	■	□	□	□	
			5.5	16.5	16.5	20	18.5	1.00 1.50 2.00	1.10	5.15	2.60	47	BB6R/L-55165-G100X BB6R/L-55165-G150X BB6R/L-55165-G200X	■	■	■	□	□	□
					27.5	30	28.5	1.00 1.50 2.00	1.10	5.15	2.60	57	BB6R/L-55275-G100X BB6R/L-55275-G150X BB6R/L-55275-G200X	■	■	■	□	□	□

Gorge
Einstecken
Grooving

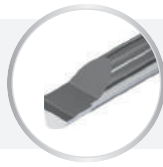

BF4... / BF6...

GX

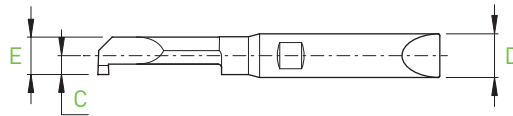
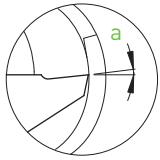
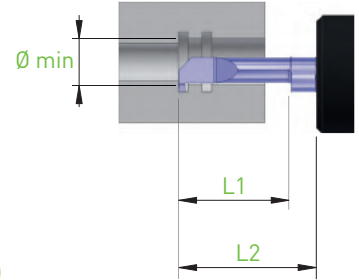
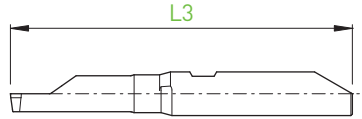
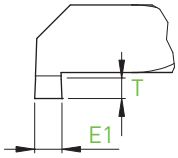

D h5	Holder	Ø min	L1	L2		E1	T	E	a	C	L3	Art. N°	R		L	
				BH4... BHY4...	BHS4... BHK4...								ZTAF	ZTAXF	ZN	ZTAF
4	BH4... BHS4... BHY4... BHK4...	0.5	1.0	10	8.5	0.15	0.10	0.45	3°	0.25	32	BF4R/L-0510-G015X	<input type="checkbox"/>	<input type="checkbox"/>	<input type="checkbox"/>	<input type="checkbox"/>
		0.7	1.4	10	8.5	0.20	0.14	0.63		0.35	32	BF4R/L-0714-G020X	<input type="checkbox"/>	<input type="checkbox"/>	<input type="checkbox"/>	<input type="checkbox"/>
		1.0	2.0	10	8.5	0.30	0.20	0.90		0.60	32	BF4R/L-1020-G030X	<input type="checkbox"/>	<input type="checkbox"/>	<input type="checkbox"/>	<input type="checkbox"/>
		1.5	3.0	10	8.5	0.40	0.30	1.35	6°	0.80	32	BF4R/L-1530-G040X	<input type="checkbox"/>	<input type="checkbox"/>	<input type="checkbox"/>	<input type="checkbox"/>
		2.0	6.0	10	8.5	0.40	0.40	1.80		1.15	32	BF4R/L-2060-G040X	<input type="checkbox"/>	<input type="checkbox"/>	<input type="checkbox"/>	<input type="checkbox"/>
		2.5	7.5	10	8.5	0.50	0.50	2.25		1.15	32	BF4R/L-2575-G050X	<input type="checkbox"/>	<input type="checkbox"/>	<input type="checkbox"/>	<input type="checkbox"/>
		3.0	9.0	15	13.5	0.50	0.60	2.70		1.45	37	BF4R/L-3090-G050X	<input type="checkbox"/>	<input type="checkbox"/>	<input type="checkbox"/>	<input type="checkbox"/>
			15.0	20	18.5	0.50	0.60	2.70		1.45	42	BF4R/L-30150-G050X	<input type="checkbox"/>	<input type="checkbox"/>	<input type="checkbox"/>	<input type="checkbox"/>
		3.5	10.5	15	13.5	0.75	0.70	3.15		1.60	37	BF4R/L-35105-G075X	<input type="checkbox"/>	<input type="checkbox"/>	<input type="checkbox"/>	<input type="checkbox"/>
			17.5	20	18.5	0.75	0.70	3.15		1.60	42	BF4R/L-35175-G075X	<input type="checkbox"/>	<input type="checkbox"/>	<input type="checkbox"/>	<input type="checkbox"/>
6	BH6... BHS6... BHY6... BHK6...	4.0	12.0	20	18.5	1.00	0.80	3.80	6°	2.20	47	BF6R/L-40120-G100X	<input type="checkbox"/>	<input type="checkbox"/>	<input type="checkbox"/>	<input type="checkbox"/>
			20.0	30	28.5	1.00	0.80	3.80		2.20	57	BF6R/L-40200-G100X	<input type="checkbox"/>	<input type="checkbox"/>	<input type="checkbox"/>	<input type="checkbox"/>
		4.5	13.5	20	18.5	1.00	0.90	4.28		2.40	47	BF6R/L-45135-G100X	<input type="checkbox"/>	<input type="checkbox"/>	<input type="checkbox"/>	<input type="checkbox"/>
			22.5	30	28.5	1.50	0.90	4.28			57	BF6R/L-45225-G100X	<input type="checkbox"/>	<input type="checkbox"/>	<input type="checkbox"/>	<input type="checkbox"/>
		5.0	15.0	20	18.5	1.00	1.00	4.75		2.50	47	BF6R/L-50150-G100X	<input type="checkbox"/>	<input type="checkbox"/>	<input type="checkbox"/>	<input type="checkbox"/>
				25.0	30	28.5	1.50	1.00			4.75	57	BF6R/L-50150-G150X	<input type="checkbox"/>	<input type="checkbox"/>	<input type="checkbox"/>
			25.0	30	28.5	1.50	1.00	4.75	57		BF6R/L-50250-G100X	<input type="checkbox"/>	<input type="checkbox"/>	<input type="checkbox"/>	<input type="checkbox"/>	
		5.5	16.5	20	18.5	1.50	1.10	5.15	2.60	47	BF6R/L-55165-G100X	<input type="checkbox"/>	<input type="checkbox"/>	<input type="checkbox"/>	<input type="checkbox"/>	
					2.00	5.15	47	BF6R/L-55165-G150X			<input type="checkbox"/>	<input type="checkbox"/>	<input type="checkbox"/>	<input type="checkbox"/>		
				2.00	5.15	1.00	5.15	47		BF6R/L-55275-G100X	<input type="checkbox"/>	<input type="checkbox"/>	<input type="checkbox"/>	<input type="checkbox"/>		
					1.50	5.15	57	BF6R/L-55275-G150X		<input type="checkbox"/>	<input type="checkbox"/>	<input type="checkbox"/>	<input type="checkbox"/>			
				2.00	5.15	1.50	5.15	57		BF6R/L-55275-G200X	<input type="checkbox"/>	<input type="checkbox"/>	<input type="checkbox"/>	<input type="checkbox"/>		
					2.00	5.15	2.00	5.15		57	BF6R/L-55275-G200X	<input type="checkbox"/>	<input type="checkbox"/>	<input type="checkbox"/>	<input type="checkbox"/>	

■ = disponible / verfügbar / available
□ = selon disponibilité du stock / jenach Lagerverfügbarkeit / depending the stock availability

IN-LINE

Fonçage-tournage
Einstecken und drehen
Grooving and turning

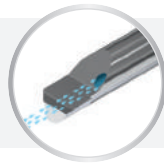

BB4... / BB6...

GTX

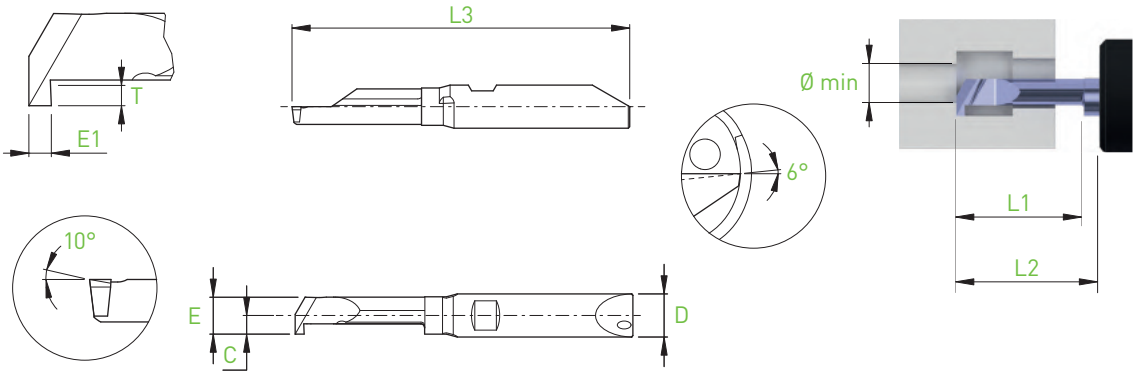

D h5	Holder	Ø min	L1	L2 BH4... BHY4...	L2 BHS4... BHK4...	E1	T	E	C	L3	Art. N°	R		L		
												ZTAF	ZTAXF	ZN	ZTAF	ZN
4	BH4... BHS4... BHY4... BHK4...	3.0	9.0	15	13.5	1.00	0.60	2.7	1.45	37	BB4R/L-3090-GT100X	■	■	■	□	□
			15.0	20	18.5	1.00	0.60	2.7	1.45	42	BB4R/L-30150-GT100X	■	■	■	□	□
	3.5	10.5	15	13.5	1.00	0.70	3.15	1.6	37	BB4R/L-35105-GT100X	■	■	■	□	□	
		17.5	20	18.5	1.00	0.70	3.15	1.6	42	BB4R/L-35175-GT100X	■	■	■	□	□	
D h5	Holder	Ø min	L1	L2 BH6... BHY6...	L2 BHS6... BHK6...	E1	T	E	C	L3	Art. N°	ZTAF	ZTAXF	ZN	ZTAF	ZN
6	BH6... BHS6... BHY6... BHK6...	4.0	14.0	20	18.5	1.25	0.80	3.8	2.2	47	BB6R/L-40140-GT125X	■	■	■	□	□
			22.0	30	28.5	1.25	0.80	3.8	2.2	57	BB6R/L-40220-GT125X	■	■	■	□	□
		4.5	16.0	20	18.5	1.25	0.90	4.28	2.4	47	BB6R/L-45160-GT125X	■	■	■	□	□
			25.0	30	28.5	1.25	0.90	4.28	2.4	57	BB6R/L-45250-GT125X	■	■	■	□	□
		5.0	17.5	20	18.5	1.25	1.00	4.75	2.5	47	BB6R/L-50175-GT125X	■	■	■	□	□
			27.5	30	28.5	1.25	1.00	4.75	2.5	57	BB6R/L-50275-GT125X	■	■	■	□	□
		5.5	17.5	20	18.5	1.25	1.10	5.15	2.6	47	BB6R/L-55175-GT125X	■	■	■	□	□
			27.5	30	28.5	1.25	1.10	5.15	2.6	57	BB6R/L-55275-GT125X	■	■	■	□	□

Fonçage-tournage

Einstechen und drehen

Grooving and turning

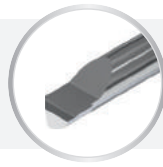

BF4... / BF6...

GTX

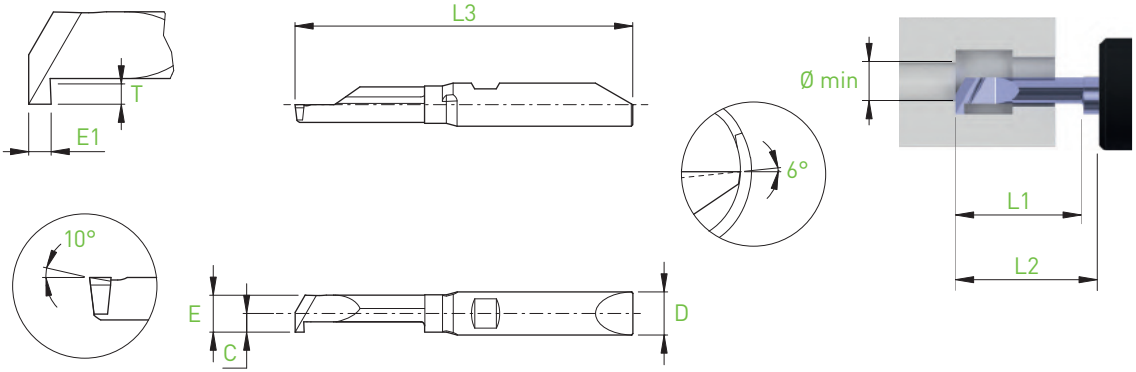

D h5	Holder	Ø min	L1	L2 BH4... BHY4...	L2 BHS4... BHK4...	E1	T	E	C	L3	Art. N°	R		L		
												ZTAF	ZTAXF	ZN	ZTAF	ZN
4	BH4... BHS4... BHY4... BHK4...	3.0	9.0	15	13.5	1.00	0.60	2.7	1.45	37	BF4R/L-3090-GT100X	■	■	■	□	□
			15.0	20	18.5	1.00	0.60	2.7	1.45	42	BF4R/L-30150-GT100X	■	■	■	□	□
	3.5	10.5	15	13.5	1.00	0.70	3.15	1.6	37	BF4R/L-35105-GT100X	■	■	■	□	□	
		17.5	20	18.5	1.00	0.70	3.15	1.6	42	BF4R/L-35175-GT100X	■	■	■	□	□	
D h5	Holder	Ø min	L1	L2 BH6... BHY6...	L2 BHS6... BHK6...	E1	T	E	C	L3	Art. N°	ZTAF	ZTAXF	ZN	ZTAF	ZN
6	BH6... BHS6... BHY6... BHK6...	4.0	14.0	20	18.5	1.25	0.80	3.8	2.2	47	BF6R/L-40140-GT125X	■	■	■	□	□
			22.0	30	28.5	1.25	0.80	3.8	2.2	57	BF6R/L-40220-GT125X	■	■	■	□	□
		4.5	16.0	20	18.5	1.25	0.90	4.28	2.4	47	BF6R/L-45160-GT125X	■	■	■	□	□
			25.0	30	28.5	1.25	0.90	4.28	2.4	57	BF6R/L-45250-GT125X	■	■	■	□	□
		5.0	17.5	20	18.5	1.25	1.00	4.75	2.5	47	BF6R/L-50175-GT125X	■	■	■	□	□
			27.5	30	28.5	1.25	1.00	4.75	2.5	57	BF6R/L-50275-GT125X	■	■	■	□	□
		5.5	17.5	20	18.5	1.25	1.10	5.15	2.6	47	BF6R/L-55175-GT125X	■	■	■	□	□
			27.5	30	28.5	1.25	1.10	5.15	2.6	57	BF6R/L-55275-GT125X	■	■	■	□	□

■ = disponible / verfügbar / available

□ = selon disponibilité du stock / jenach Lagerverfügbarkeit / depending the stock availability

IN-LINE

Filetage
Gewindedrehen
Threading

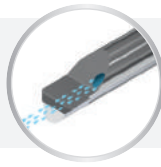

BB4... / BB6...

TP60

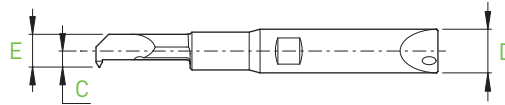
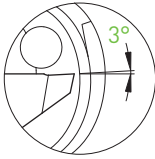
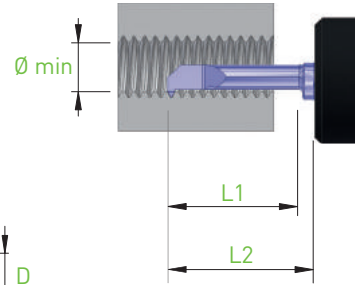
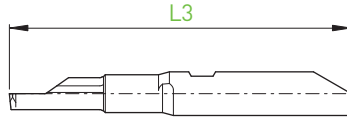
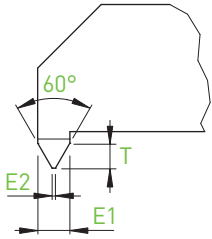

D h5	Holder	Ø min	L1	L2		P (mm)	P (TPI)	E1	E2 (0/-0.01)	T	E	C	L3	Art. N°	R		L	
				BH4... BHY4...	BHS4... BHK4...										ZTAF ZN	ZTAF ZN	ZTAF ZN	ZTAF ZN
4	BH4... BHS4... BHY4... BHK4...	1.25	3.2	10	8.5	0.20-0.35	80	0.30	0.02	0.25	1.10	0.80	32	BB4R/L-1232-TP60	■	■	□	□
		1.6	4.0	10	8.5	0.25-0.40	72-64	0.35	0.03	0.28	1.41	0.90	32	BB4R/L-1640-TP60	■	■	□	□
		2.5	6.0	10	8.5	0.35-0.50	56-48	0.44	0.04	0.34	2.25	1.35	32	BB4R/L-2560-TP60	■	■	□	□
			9.0	15	13.5	0.35-0.50	56-48	0.44	0.04	0.34	2.25	1.35	37	BB4R/L-2590-TP60	■	■	□	□
		3.3	8.0	15	13.5	0.50-0.75	40-36	0.62	0.06	0.48	2.97	1.50	37	BB4R/L-3380-TP60	■	■	□	□
12.0	15		13.5	0.50-0.75	40-36	0.62	0.06	0.48	2.97	1.50	37	BB4R/L-33120-TP60	■	■	□	□		
6	BH6... BHS6... BHY6... BHK6...	4.2	10.0	20	18.5	0.50-0.80	36-32	0.70	0.06	0.55	3.78	2.10	47	BB6R/L-42100-TP60	■	■	□	□
			15.0	20	18.5	0.50-0.80	36-32	0.70	0.06	0.55	3.78	2.10	47	BB6R/L-42150-TP60	■	■	□	□
		5.0	12.0	20	18.5	0.75-1.00	28-24	0.89	0.09	0.69	4.50	2.20	47	BB6R/L-50120-TP60	■	■	□	□
			18.0	20	18.5	0.75-1.00	28-24	0.89	0.09	0.69	4.50	2.20	47	BB6R/L-50180-TP60	■	■	□	□

Filetage
Gewindedrehen
Threading

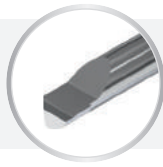

BF4... / BF6...

TP60

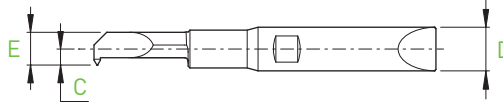
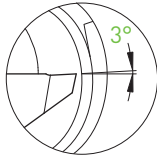
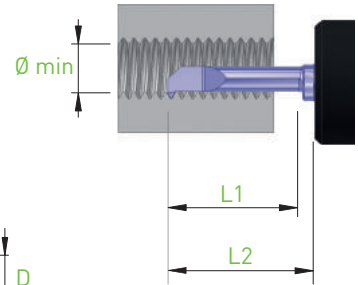
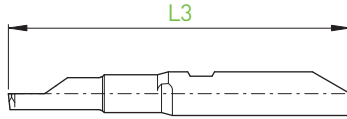
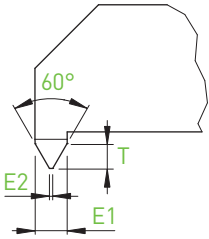

D _{h5}	Holder	Ø min	L1	L2 BH4... BHY4...	L2 BHS4... BHK4...	P (mm)	P (TPI)	E1	E2 (0/-0.01)	T	E	C	L3	Art. N°	R		L	
															ZTAF	ZN	ZTAF	ZN
4	BH4... BHS4... BHY4... BHK4...	1.25	3.2	10	8.5	0.20-0.35	80	0.30	0.02	0.25	1.10	0.80	32	BF4R/L-1232-TP60	■	■	□	□
		1.6	4.0	10	8.5	0.25-0.40	72-64	0.35	0.03	0.28	1.41	0.90	32	BF4R/L-1640-TP60	■	■	□	□
		2.5	6.0	10	8.5	0.35-0.50	56-48	0.44	0.04	0.34	2.25	1.35	32	BF4R/L-2560-TP60	■	■	□	□
			9.0	15	13.5	0.35-0.50	56-48	0.44	0.04	0.34	2.25	1.35	37	BF4R/L-2590-TP60	■	■	□	□
		3.3	8.0	15	13.5	0.50-0.75	40-36	0.62	0.06	0.48	2.97	1.50	37	BF4R/L-3380-TP60	■	■	□	□
12.0	15		13.5	0.50-0.75	40-36	0.62	0.06	0.48	2.97	1.50	37	BF4R/L-33120-TP60	■	■	□	□		
6	BH6... BHS6... BHY6... BHK6...	4.2	10.0	20	18.5	0.50-0.80	36-32	0.70	0.06	0.55	3.78	2.10	47	BF6R/L-42100-TP60	■	■	□	□
			15.0	20	18.5	0.50-0.80	36-32	0.70	0.06	0.55	3.78	2.10	47	BF6R/L-42150-TP60	■	■	□	□
		5.0	12.0	20	18.5	0.75-1.00	28-24	0.89	0.09	0.69	4.50	2.20	47	BF6R/L-50120-TP60	■	■	□	□
			18.0	20	18.5	0.75-1.00	28-24	0.89	0.09	0.69	4.50	2.20	47	BF6R/L-50180-TP60	■	■	□	□

■ = disponible / verfügbar / available
□ = selon disponibilité du stock / jenach Lagerverfügbarkeit / depending the stock availability

IN-LINE

Filetage
Gewindedrehen
Threading

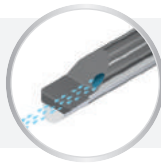

BB4... / BB6...

TP55

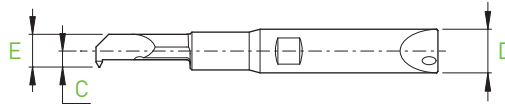
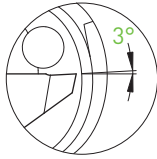
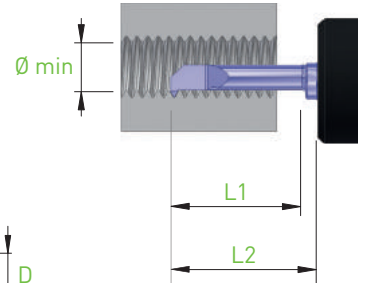
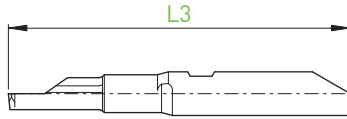
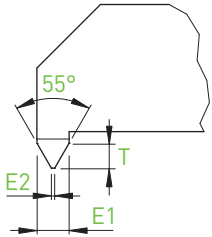

D _{h5}	Holder	Ø min	L1	L2 BH4... BHY4...	L2 BHS4... BHK4...	P (TPI)	E1	E2 [0/-0.02]	T	E	C	L3	Art. N°	R		L	
														ZTAF	ZN	ZTAF	ZN
4	BH4...	1.85	4.5	10	8.5	48	0.54	0.09	0.44	1.67	0.97	32	BB4R/L-1845-TP55	■	■	□	□
	BHS4...																
	BHY4... BHK4...	2.55	6.0	10	8.5	40	0.64	0.10	0.52	2.25	1.35	32	BB4R/L-2560-TP55	■	■	□	□
D _{h5}	Holder	Ø min	L1	L2 BH6... BHY6...	L2 BHS6... BHK6...	P (TPI)	E1	E2 [0/-0.02]	T	E	C	L3	Art. N°	ZTAF	ZN	ZTAF	ZN
6	BH6...	3.70	11.0	20	18.5	32-24	1.08	0.13	0.91	3.33	1.83	47	BB6R/L-37110-TP55	■	■	□	□
	BHS6...	5.10	15.0	20	18.5	26-20	1.30	0.16	1.09	4.60	2.05	47	BB6R/L-51150-TP55	■	■	□	□
	BHY6...																
	BHK6...	5.50	16.0	20	18.5	22-16	1.48	0.19	1.24	5.15	2.60	47	BB6R/L-55160-TP55	■	■	□	□

Filetage
Gewindedrehen
Threading

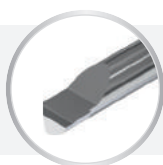

BF4... / BF6...

TP55

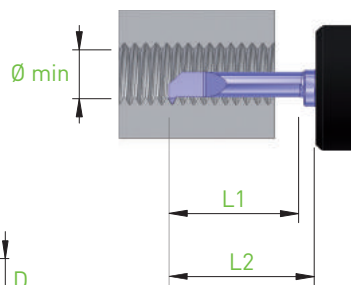
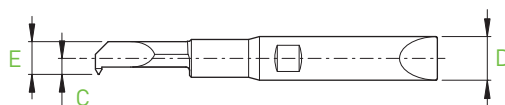
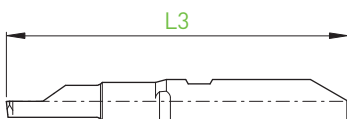
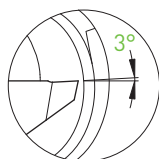
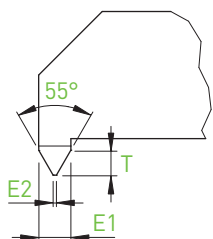

D _{h5}	Holder	Ø min	L1	L2 BH4... BHY4...	L2 BHS4... BHK4...	P (TPI)	E1	E2 (0/-0.02)	T	E	C	L3	Art. N°	R		L	
														ZTAF ZN	ZN	ZTAF ZN	ZN
4	BH4...	1.85	4.5	10	8.5	48	0.54	0.09	0.44	1.67	0.97	32	BF4R/L-1845-TP55	■	■	□	□
	BHS4...																
	BHY4... BHK4...	2.55	6.0	10	8.5	40	0.64	0.10	0.52	2.25	1.35	32	BF4R/L-2560-TP55	■	■	□	□
6	BH6...	3.70	11.0	20	18.5	32-24	1.08	0.13	0.91	3.33	1.83	47	BF6R/L-37110-TP55	■	■	□	□
	BHS6...	5.10	15.0	20	18.5	26-20	1.30	0.16	1.09	4.60	2.05	47	BF6R/L-51150-TP55	■	■	□	□
	BHY6...																
	BHK6...	5.50	16.0	20	18.5	22-16	1.48	0.19	1.24	5.15	2.60	47	BF6R/L-55160-TP55	■	■	□	□

■ = disponible / verfügbar / available
□ = selon disponibilité du stock / jenach Lagerverfügbarkeit / depending the stock availability

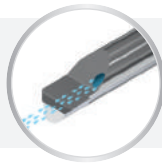

Profil complet métrique
Metrisches Vollprofil
Metric full profile

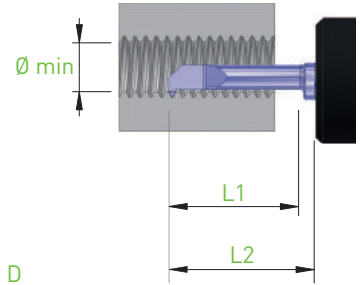
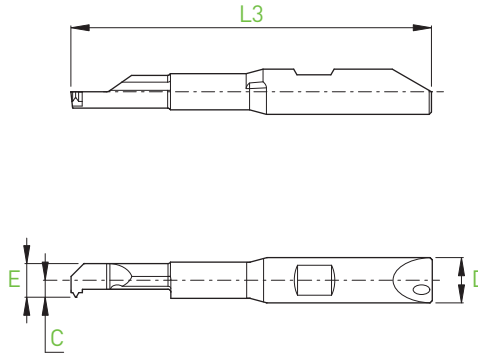
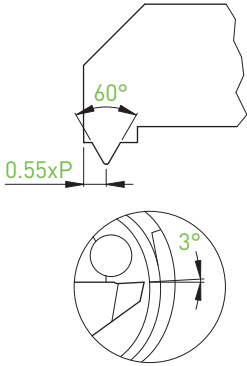

D h5	Holder	M (min)	Ø min	P (mm)	L1	L2	L2	E	C	L3	Art. N°	R	
						BH4... BHY4...	BHS4... BHK4...					ZTAF	ZN
4	BH4... BHS4... BHY4... BHK4...	M3x0.5	2.50	0.50	6.0	10	8.5	2.25	1.35	32	BB4R-2560-TM-0.50	■	■
		M4x0.7	3.30	0.70	8.0	15	13.5	2.97	1.50	37	BB4R-3380-TM-0.70	■	■
D h5	Holder	M (min)	Ø min	P (mm)	L1	L2	L2	E	C	L3	Art. N°	ZTAF	ZN
6	BH6... BHS6... BHY6... BHK6...	M5x0.8	4.20	0.80	10.0	20	18.5	3.78	2.10	47	BB6R-42100-TM-0.80	■	■
		M6x1.0	5.00	1.00	12.0	20	18.5	4.50	2.20	47	BB6R-50120-TM-1.00	■	■

Filetage
Gewindedrehen
Threading



BF4... / BF6...

TM

Profil complet métrique
Metrisches Vollprofil
Metric full profile

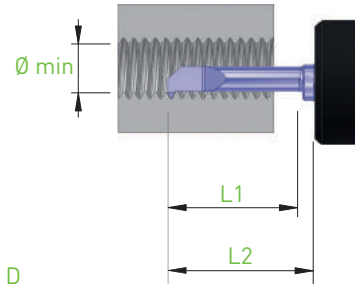
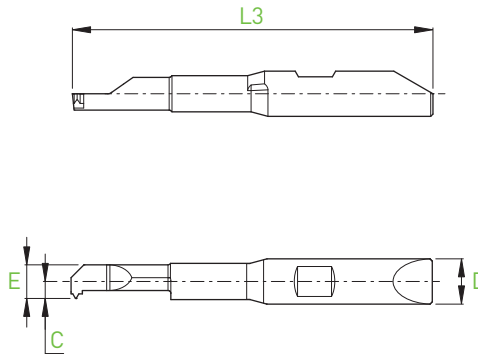
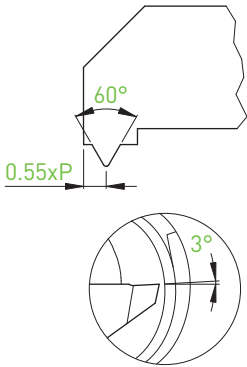

R

D h5	Holder	M (min)	Ø min	P (mm)	L1	L2 BH4... BHY4...	L2 BHS4... BHK4...	E	C	L3	Art. N°	ZTAF	ZN
4	BH4... BHS4... BHY4... BHK4...	M3x0.5	2.50	0.50	6.0	10	8.5	2.25	1.35	32	BF4R-2560-TM-0.50	■	■
		M4x0.7	3.30	0.70	8.0	15	13.5	2.97	1.50	37	BF4R-3380-TM-0.70	■	■
D h5	Holder	M (min)	Ø min	P (mm)	L1	L2 BH6... BHY6...	L2 BHS6... BHK6...	E	C	L3	Art. N°	ZTAF	ZN
6	BH6... BHS6... BHY6... BHK6...	M5x0.8	4.20	0.80	10.0	20	18.5	3.78	2.10	47	BF6R-42100-TM-0.80	■	■
		M6x1.0	5.00	1.00	12.0	20	18.5	4.50	2.20	47	BF6R-50120-TM-1.00	■	■

IN-LINE

- Gorge frontale extérieure
- Aussen axiales stechen
- External axial grooving

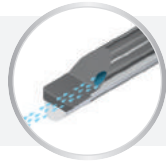

BB6...

FEG

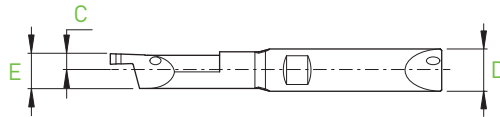
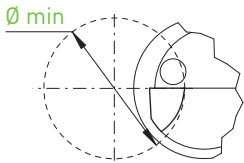
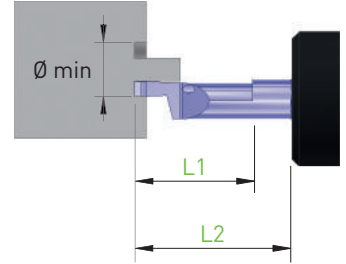
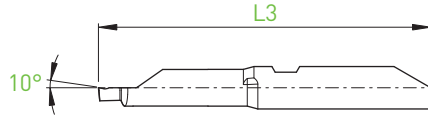
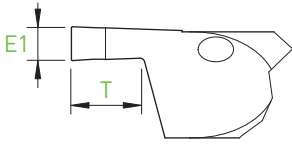

R

D h5	Holder	Ø min	L1	L2 BH6... BHY6...	L2 BHS6... BHK6...	T	E	C	E1	L3	Art. N°	ZTAF	ZN
6	BH6... BHS6... BHY6... BHK6...	5.0	15.0	20	18.5	3.00	4.90	2.30	1.50	47	BB6R-50150-FEG150X	■	■

P
 M
 N
 S
 P
 N
 S

Gorge frontale intérieure

Innen axiales stechen

Internal axial grooving

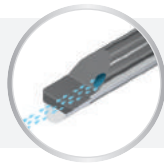

BB6...

FIG

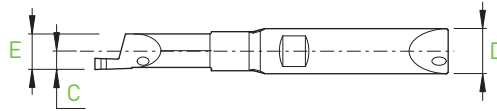
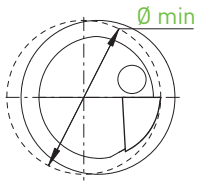
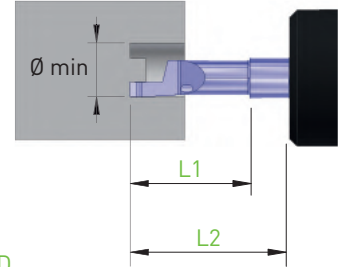
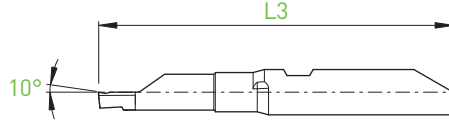
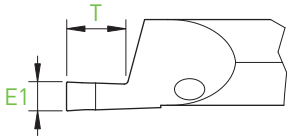

R

D h5	Holder	Ø min	L1	L2 BH6... BHY6...	L2 BHS6... BHK6...	T	E	C	E1	L3	Art. N°	ZTAF	ZN
6	BH6... BHS6... BHY6... BHK6...	5.0	15.0	20	18.5	3.00	4.75	2.45	1.50	47	BB6R-50150-FIG150X	■	■

■ = disponible / verfügbar / available

□ = selon disponibilité du stock / jenach Lagerverfügbarkeit / depending the stock availability

IN-LINE

Ébauches avec arrosage
 Rohlinge mit Kühlung
 Blanks with coolant

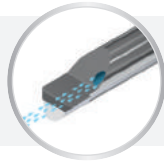

BB4... / BB6...

BB_E

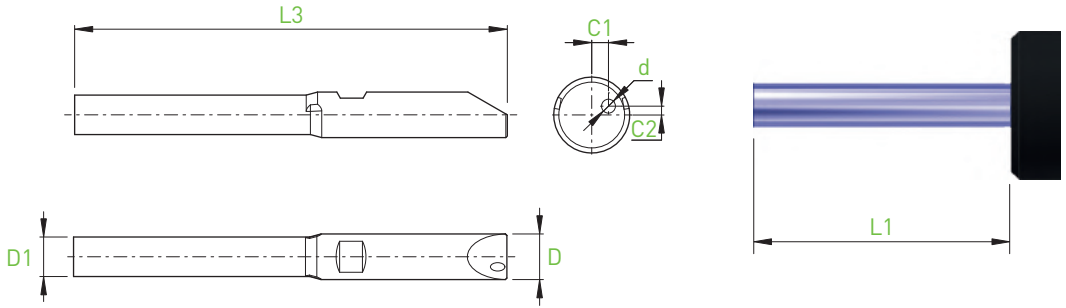

D _{h5}	Holder	L1 BH4... BHY4...	L1 BHS4... BHK4...	D1	C1	C2	d	L3	Art. N°	ZN
4	BH4... BHS4... BHY4... BHK4...	20.0	18.5	3.20	0.84	0.55	0.85	42	BB4R-E42	■
D _{h5}	Holder	L1 BH6... BHY6...	L1 BHS6... BHK6...	D1	C1	C2	d	L3	Art. N°	ZN
6	BH6... BHS6... BHY6... BHK6...	30.0	28.5	5.20	1.33	0.70	1.10	57	BB6R-E57	■

Ébauches

Rohlinge

Blanks



BF4... / BF6...

BF_E

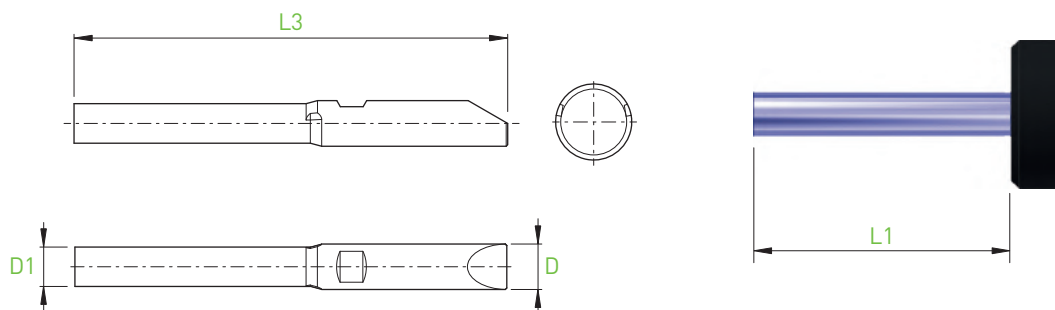

D _{h5}	Holder	L1 BH4... BHY4...	L1 BHS4... BHK4...	D1	L3	Art. N°	ZN
4	BH4... BHS4... BHY4... BHK4...	20.0	18.5	3.20	42	BF4-E42	■
D _{h5}	Holder	L1 BH6... BHY6...	L1 BHS6... BHK6...	D1	L3	Art. N°	ZN
6	BH6... BHS6... BHY6... BHK6...	30.0	28.5	5.20	57	BF6-E57	■

IN-LINE

Jauges d'alignement
Richtplatten
Adjusting tools

MASTER

BH4 / BH6

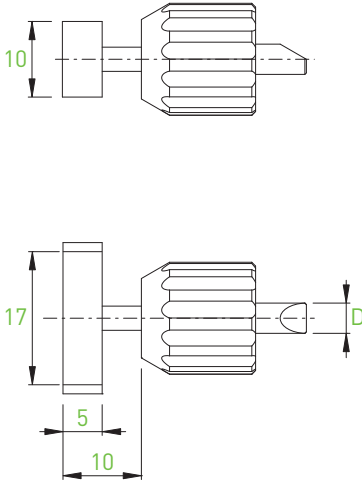

D h5	Art. N°	
4	BH4-MASTER	■
6	BH6-MASTER	■

Jauges d'alignement
Richtplatten
Adjusting tools

MASTER

BHSY...

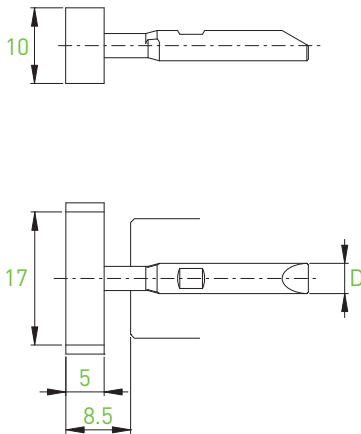

D h5	Art. N°	
4	BHSY4-MASTER	■
6	BHSY6-MASTER	■

Porte-outils avec arrosage pour contre-opération - Machines STAR
 Halter mit Kühlungssystem für Gegenbearbeitung – STAR-Maschinen
 Backworking holders with through coolant – STAR-Machines

BH4 / BH6
 BHS4 / BHS6

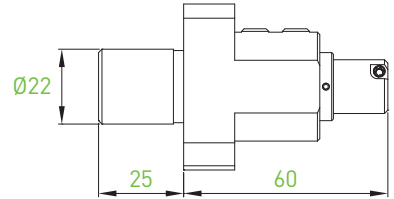
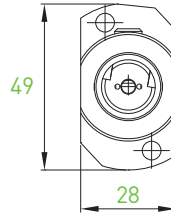

Art. N°

BWD1-2022-STAR-SRR

Art. N°

BHS4-D20-55-BWD1
 BHS6-D20-55-BWD1

Types of STAR machines

SR10J (T22+T24)
 SB16/20 Types C + D + E (T21-T24)
 SB20R Types E + G + N (T21-T24)
 SR20J / JN (T21-T24)
 SR20R / II / III (T21-T24)
 SR20R IV (T21-T24)
 SR32J/JN (T21-T24)
 SW12RII (T21-T24)
 SV20R (T21-T24)
 ECAS12/20 (T21-T24)
 SW20 (T21-T23)

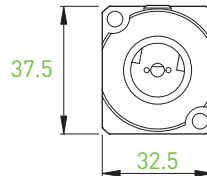
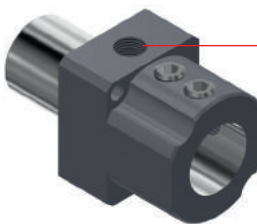

Art. N°

BWD1-2022-STAR-SW

Art. N°

BHS4-D20-55-BWD1
 BHS6-D20-55-BWD1

Types of STAR machines

SW12RII (T21-T28)
 SW20 (T21-T23 + T25-T27)
 SV20R (T21-T28)
 SR-20R IV (T21-T28)
 SB12/20R (T22-T24)
 SR38 (T21-T28)

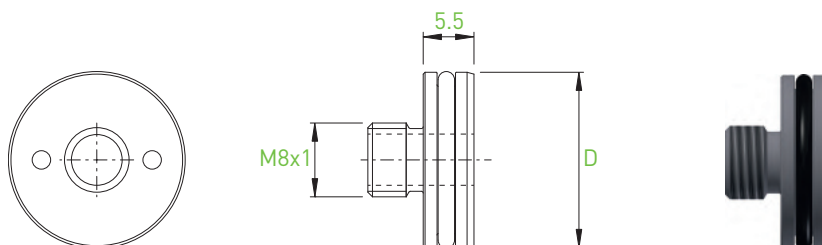
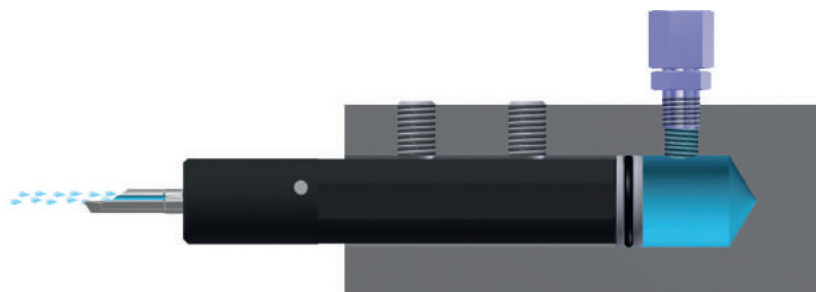

D	Art. N°	
19.05	JB-M8X1-D19.05	■
20	JB-M8X1-D20	■
22	JB-M8X1-D22	■
25	JB-M8X1-D25	■
25.4	JB-M8X1-D25.4	■

JET-LINE

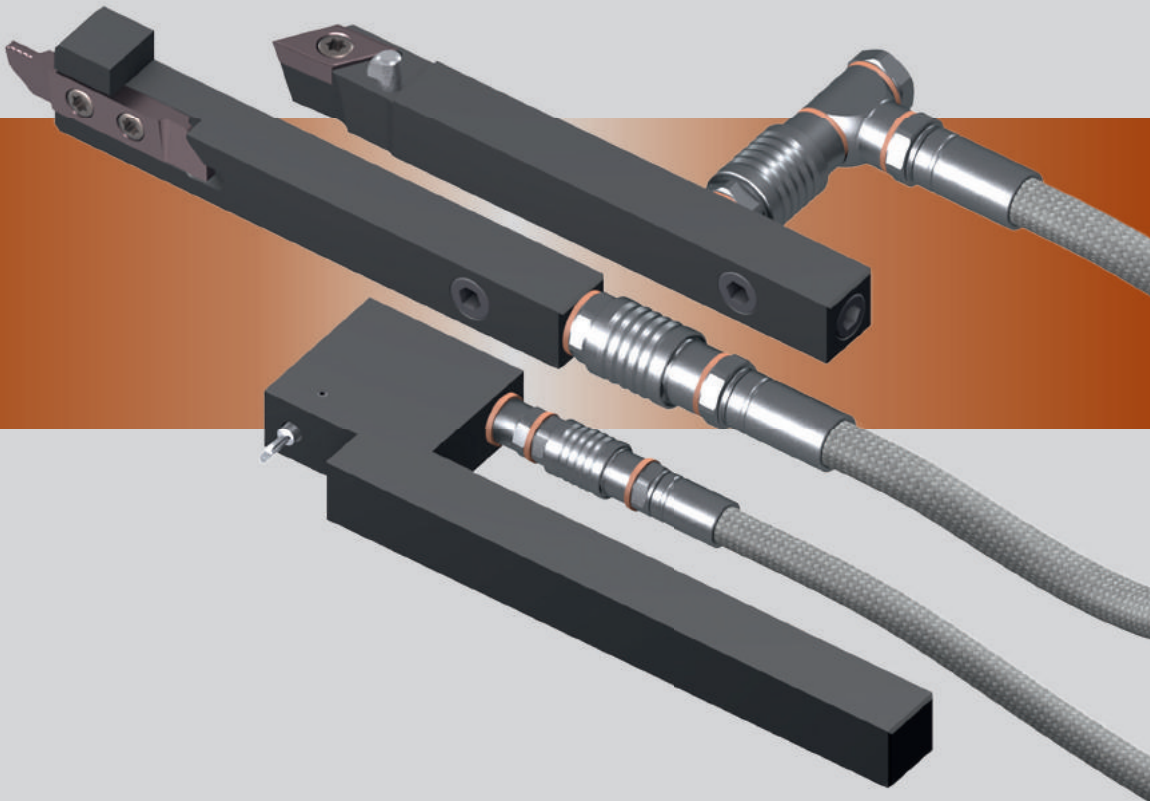

DISCOVER JET-LINE IN CHAPTER 16!

Avantages
Vorteile
Advantages

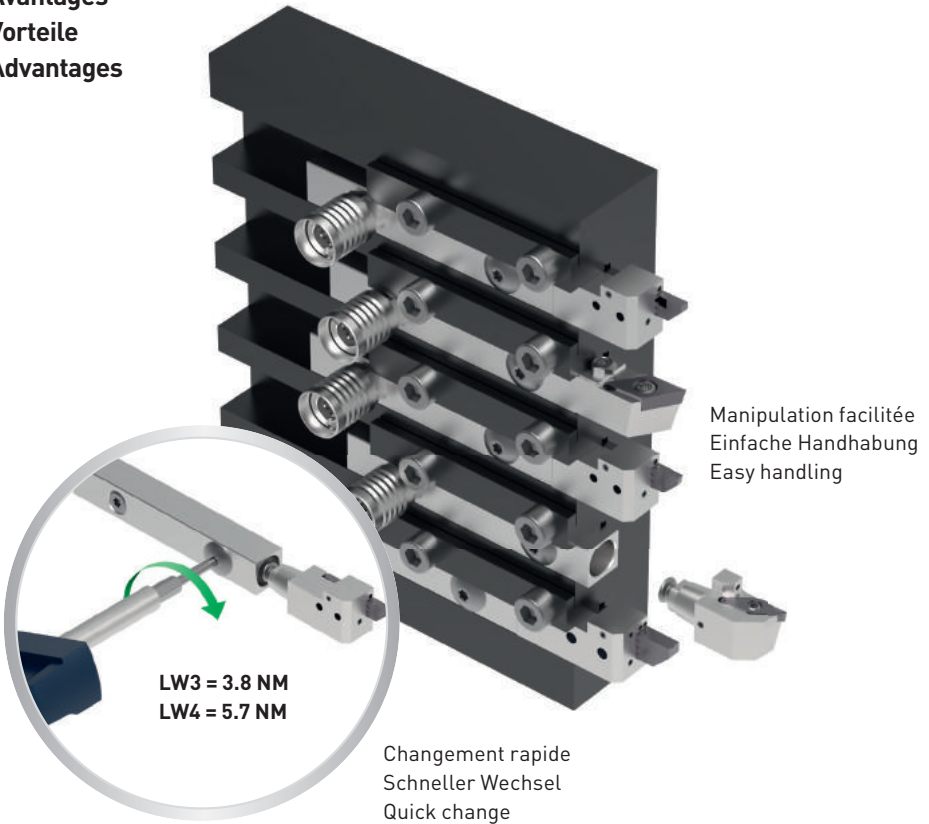

Lubrification intégrée
Integrierte Kühlung
Integrated coolant

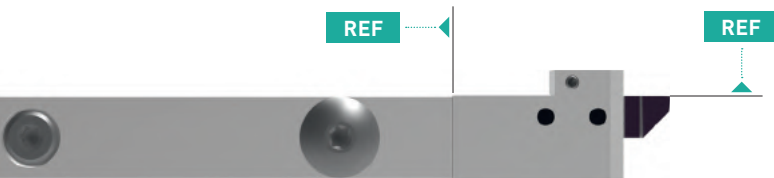
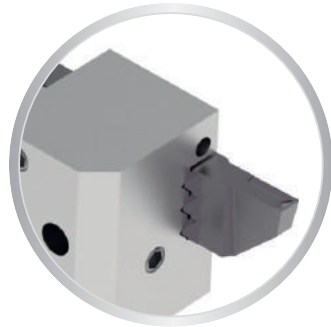

Excellente répétabilité
Ausgezeichnete
Wiederholgenauigkeit
Excellent repeatability

INFO > **11.02**

Supports carrés
Viereckige Halter
Square holders



> **11.05**

Têtes interchangeables | Wechsetköpfe | Interchangeable heads

TOP-Line



LW-730-740

> **11.06**

LW-750-760

> **11.07**

LW-770-780

> **11.08**

TURN-Line



88°

LW-310-320

> **11.09**

LW-310-BC/320-BC

> **11.10**

85°

LW-330-340

> **11.11**

ISO-Line



80°

LW-SCL

> **11.12**

LW-SCM

> **11.13**

55°

LW-SDJ

> **11.14**

LW-SDN

> **11.15**

LW-SDH

> **11.16**

35°

LW-SVJ

> **11.17**

LW-SVV

> **11.18**

Supports cylindriques
Zylindrische Halter
Cylinder holders



> **11.19**

Têtes interchangeables porte-pince
Spannzangenwechsetköpfe
Interchangeable head gripper holder



> **11.20**

Porte-outils
Halter
Holders



> **11.21**

SWITCH-LINE

Désignations - Carrés
 Bezeichnungen - Quadrat
 Designation - Square

INFO

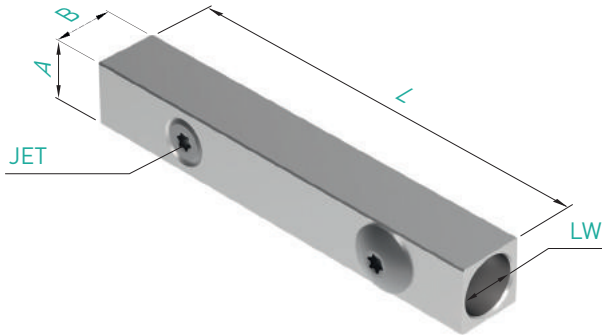

LW	A x B	L	JET
Interface	Section	Longueur Länge Length	Arrosage intégré Integrierte Kühlung Integrated coolant

Désignations - Têtes interchangeables
 Bezeichnungen - Wechselköpfe
 Designation - Interchangeable heads

INFO

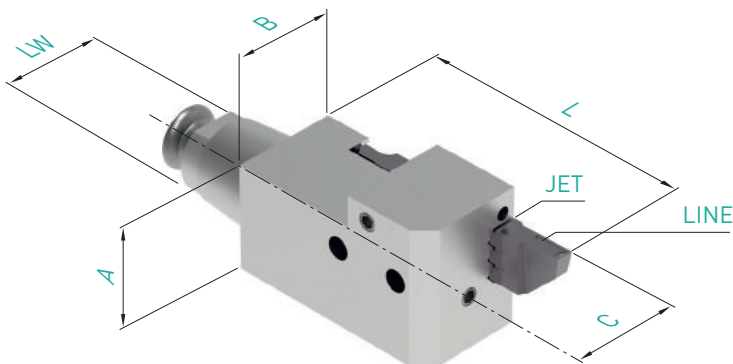

LW	LINE	A x B	C	L	JET
Interface	Serie	Section	Localisation axe Achselokalisation Axis location	Longueur Länge Length	Arrosage intégré Integrierte Kühlung Integrated coolant

Désignations - Cylindres

Bezeichnungen - Zylinder

Designations - Cylinder

INFO

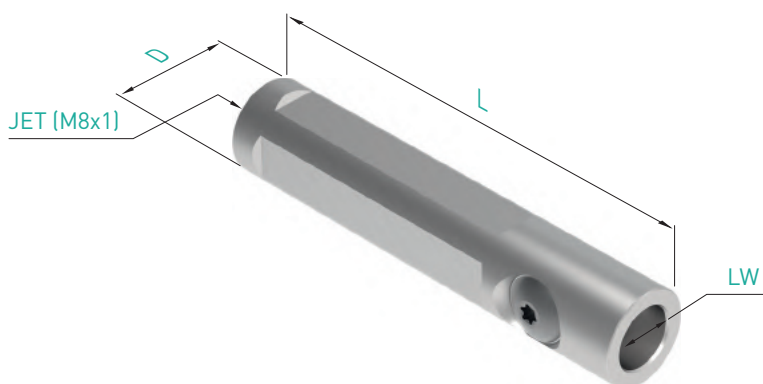

LW	D	L	JET
Interface	∅	Longueur Länge Length	Arrosage intégré Integrierte Kühlung Integrated coolant

Désignations - Têtes porte-pinces

Bezeichnungen - Spannzangenköpfe

Designation - Gripper holder heads

INFO

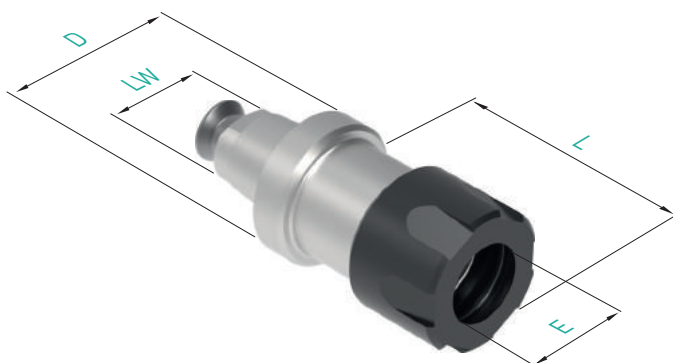

LW	E	D	L
Interface	Pince type Spannzange Typ Gripper type	∅	Longueur Länge Length

SWITCH-LINE

- Désignations - HSK
- Bezeichnungen - HSK
- Designation - HSK

INFO

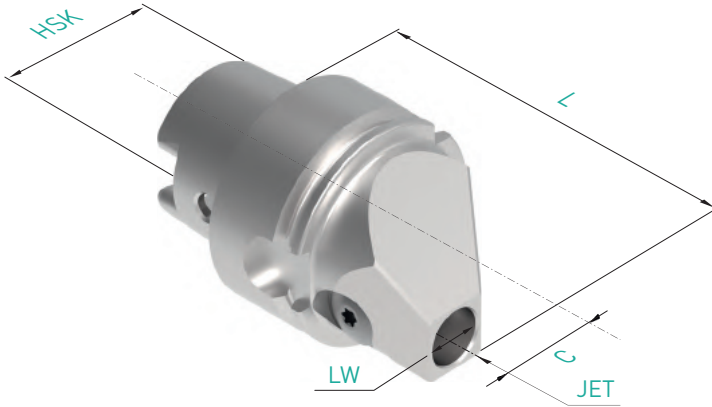



HSK	LW	C	L	JET	X
Machine interface	Interface tête interchangeable Wechselkopfschnittstelle Interchangeable head interface	Localisation axe Achsellokalisierung Axis location LW	Longueur Länge Length	Arrosage intégré Integrierte Kühlung Integrated coolant	Spécificité fabricant machine Spezifität Maschinenhersteller Specificity machine manufacturer

Supports carrés
 Viereckige Halter
 Square holders

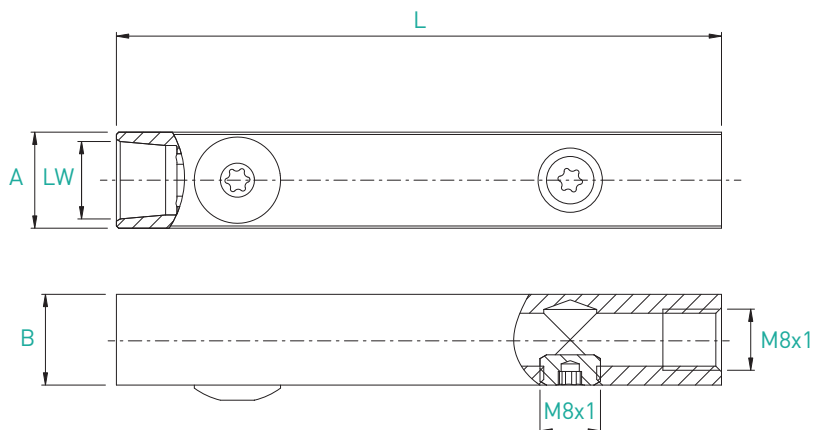
LW-JET

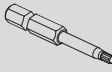

Pièces recharges Ersatzteile Spare parts		Options	
			

LW	A x B	L	Art. N°	Art. N°	Art. N°	Art. N°	Art. N°
LW3	12x12	80	LW3-1212-80-JET	JB-M8X1	LW3-ER1.012.014	CD-NM3.8	TX15-E6.3
LW3	12.7x12	80	LW3-12.7-80-JET				
LW4	15.87x16	25	LW4-15.87-80-JET	JB-M8X1	LW4-ER1.014.019	CD-NM5.7	TX20-E6.3
LW4	16x16	25	LW4-1616-80-JET				



Utilisation clé dynamométrique recommandée
 Benutzung eines Drehmomentschlüssels empfohlen
 Recommended use of dynamometric key

Options	
	Art. N°
	M8X1 voir JET-LINE siehe JET-LINE see JET-LINE

SWITCH-LINE



Têtes interchangeables
 Wechselköpfe
 Interchangeable heads

TOP-Line

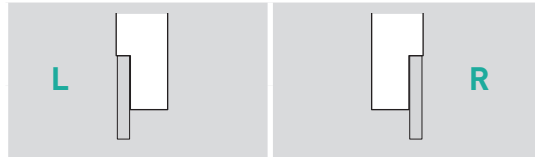
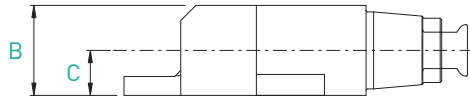
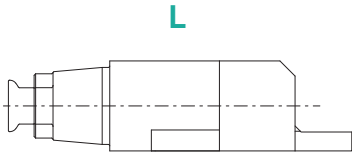
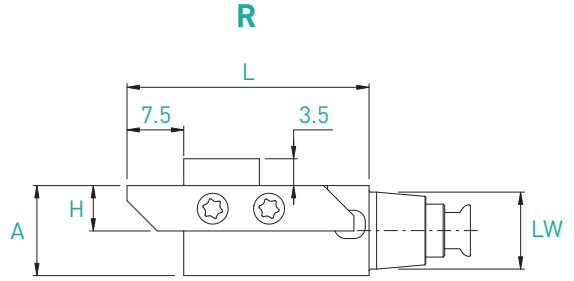
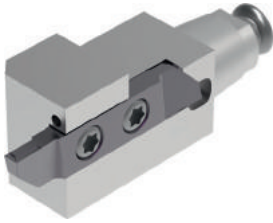
LW-730/740-JET

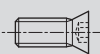

Plaquettes WSP Inserts	LW	A x B	H	C	L	Art. N°	
						L	R
73_-74_	LW3	12x12	6	6	32	LW3-730-12-0632-JET	LW3-740-12-0632-JET
	LW4	16x16	8	8	32	LW4-730-16-0832-JET	LW4-740-16-0832-JET

Pièces de rechange Ersatzteile Spare parts	LW			
		Art. N°	Art. N°	Art. N°
		LW3	V-M3X7-T8	C-T8
LW4			LW4-U00.ER1.000	

Têtes interchangeables

Wechselköpfe



Interchangeable heads

TOP-Line

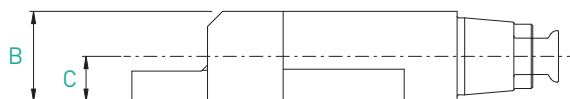
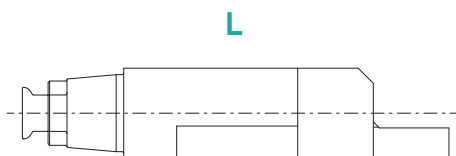
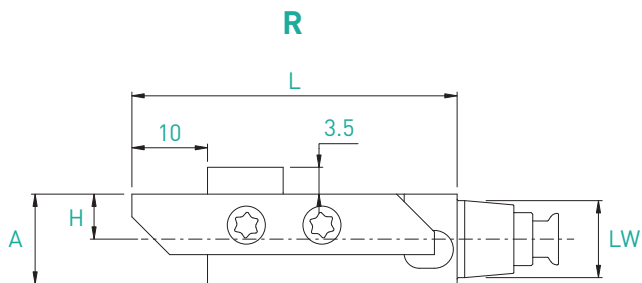
LW-750/760-JET

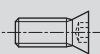

Plaquettes WSP Inserts	LW	A x B	H	C	L	Art. N°	
						Art. N°	Art. N°
75_-76_	LW3	12x12	6	6	43	LW3-750-12-0643-JET	LW3-760-12-0643-JET
	LW4	16x16	8	8	43	LW4-750-16-0843-JET	LW4-760-16-0843-JET

Pièces de rechange Ersatzteile Spare parts	LW			
		Art. N°	Art. N°	Art. N°
		LW3	V-M4X9-T15	C-T15
LW4			LW4-U00.ER1.000	

SWITCH-LINE

Têtes interchangeables
 Wechselköpfe
 Interchangeable heads

TOP-Line

LW-770/780-JET

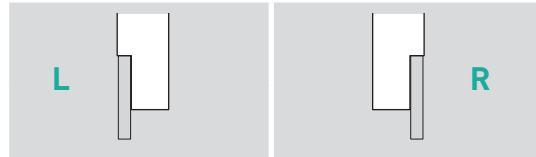
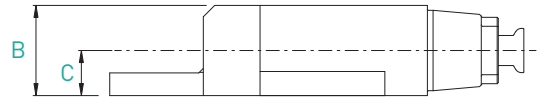
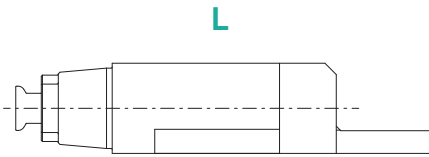
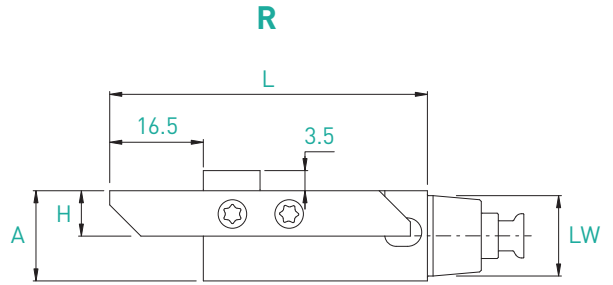
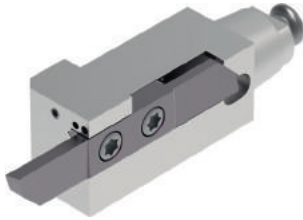

Plaquettes WSP Inserts	LW	A x B	H	C	L	Art. N°	Art. N°
77_-78_	LW4	16x16	8	8	56	LW4-770-16-0856-JET	LW4-780-16-0856-JET

Pièces de rechange Ersatzteile Spare parts	LW	Art. N°	Art. N°	Art. N°
	LW4	V-M4X9-T15	C-T15	LW4-U00.ER1.000

Têtes interchangeables

Wechselköpfe



Interchangeable heads

TURN-Line 88°

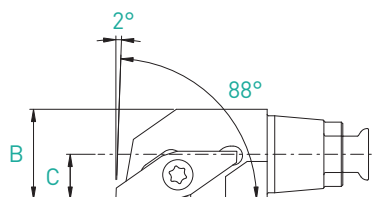
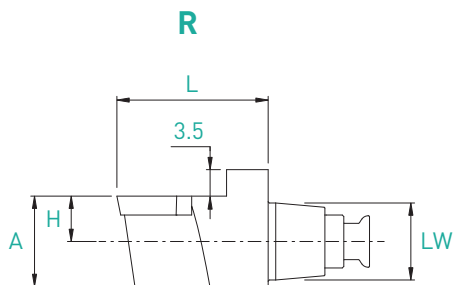
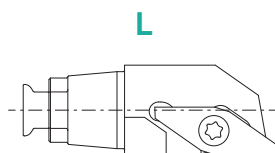
LW-310/320-JET

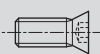

Plaquettes WSP Inserts	LW	A x B	H	C	L	Art. N°	
						Art. N°	Art. N°
31_-32_	LW3	12x12	6	6	20	LW3-310-12-0620-JET	LW3-320-12-0620-JET
	LW4	16x16	8	8	25	LW4-310-16-0825-JET	LW4-320-16-0825-JET

Pièces de rechange Ersatzteile Spare parts	LW			
		Art. N°	Art. N°	Art. N°
	LW3	V-M2.5X7.8-T8	C-T8	LW3-U00.ER1.000
	LW4			LW4-U00.ER1.000

SWITCH-LINE

Têtes interchangeables
 Wechselköpfe
 Interchangeable heads



TURN-Line

88°

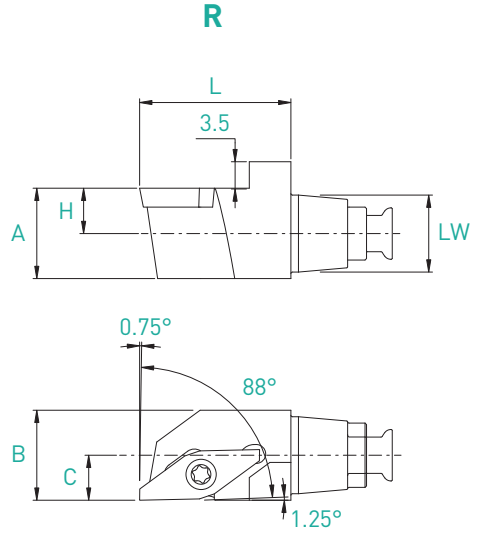
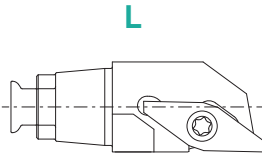
LW-310-BC/320-BC-JET

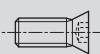

Plaquettes WSP Inserts	LW	A x B	H	C	L	Art. N°	
						L	R
31_-32_	LW3	12x12	6	6	20	LW3-310-12-0620-BC-JET	LW3-320-12-0620-BC-JET
	LW4	16x16	8	8	25	LW4-310-16-0825-BC-JET	LW4-320-16-0825-BC-JET

Pièces de rechange Ersatzteile Spare parts	LW			
		Art. N°	Art. N°	Art. N°
LW3	V-M2.5X7.8-T8	C-T8	LW3-U00.ER1.000	
LW4			LW4-U00.ER1.000	

Têtes interchangeables

Wechselköpfe



Interchangeable heads

TURN-Line 85°

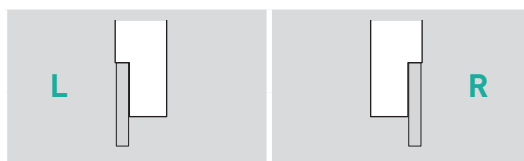
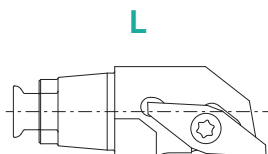
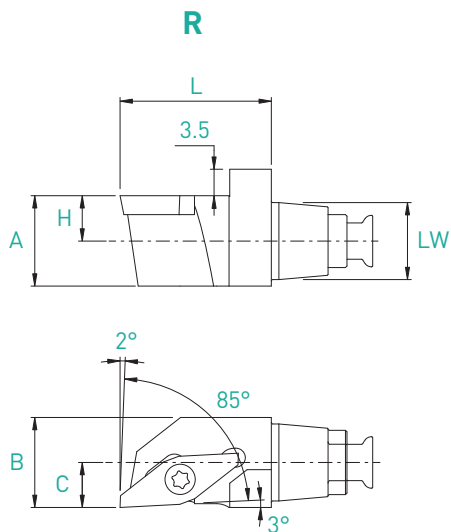
LW-330/340-JET

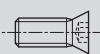

Plaquettes WSP Inserts	LW	A x B	H	C	L	Art. N°	
						Art. N°	Art. N°
33_-34_	LW3	12x12	6	6	20	LW3-330-12-0620-JET	LW3-340-12-0620-JET
	LW4	16x16	8	8	25	LW4-330-16-0825-JET	LW4-340-16-0825-JET

Pièces de rechange Ersatzteile Spare parts	LW			
		Art. N°	Art. N°	Art. N°
	LW3	V-M2.5X7.8-T8	C-T8	LW3-U00.ER1.000
	LW4			LW4-U00.ER1.000

SWITCH-LINE

Têtes interchangeables
Wechselköpfe
Interchangeable heads

ISO-Line 80°

LW-SCL-JET

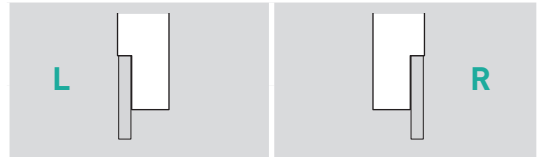
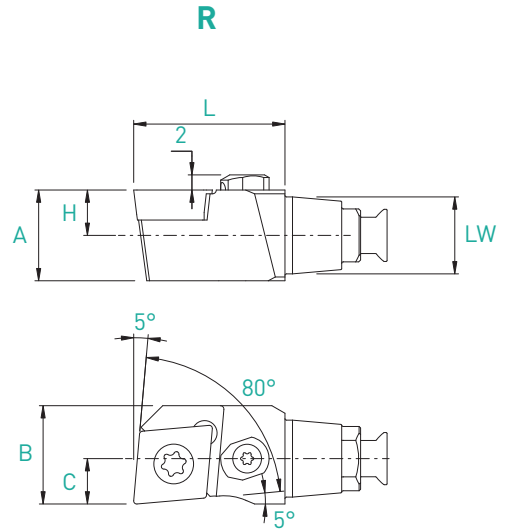
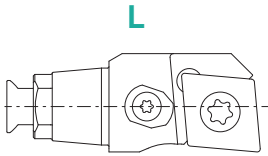

Plaquettes WSP Inserts	LW	A x B	H	C	L	Art. N°	
						Art. N°	Art. N°
CC...-0602..	LW3	12x12	6	6	20	LW3-SCLCL-12-0620-06-JET	LW3-SCLCR-12-0620-06-JET
	LW4	16x16	8	8	25	LW4-SCLCL-16-0825-06-JET	LW4-SCLCR-16-0825-06-JET
CC...-09T3..	LW3	12x12	6	6	20	LW3-SCLCL-12-0620-09-JET	LW3-SCLCR-12-0620-09-JET
	LW4	16x16	8	8	25	LW4-SCLCL-16-0825-09-JET	LW4-SCLCR-16-0825-09-JET

Pièces de rechange Ersatzteile Spare parts	Plaquettes WSP Inserts	LW	Art. N°	Art. N°	Art. N°	Art. N°
			Art. N°	Art. N°	Art. N°	Art. N°
CC...-0602..	LW3	V-M2.5X7.8-T8	C-T8	LWX-ER1.007.002	LW3-U00.ER1.000	
	LW4				LW4-U00.ER1.000	
CC...-09T3..	LW3	V-M4X9-T15-ISO	C-T15	LWX-ER1.007.002	LW3-U00.ER1.000	
	LW4				LW4-U00.ER1.000	

Têtes interchangeables

Wechselköpfe

Interchangeable heads



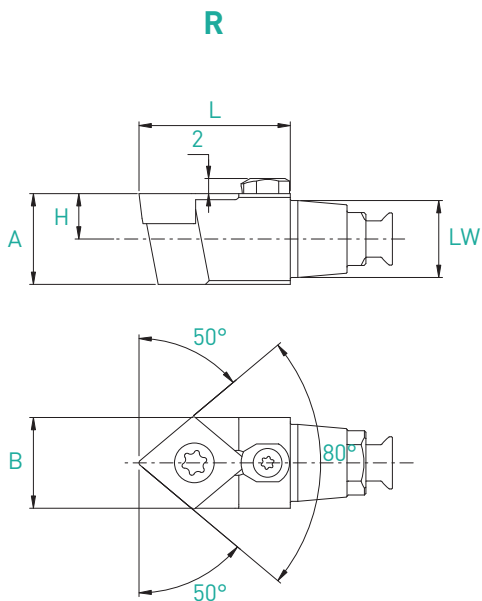

ISO-Line

80°

LW-SCM-JET

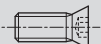

Plaquettes WSP Inserts	LW	A x B	H	L	Art. N°
CC...-0602..	LW3	12x12	6	20	LW3-SCMCN-12-0020-06-JET
	LW4	16x16	8	25	LW4-SCMCN-16-0025-06-JET
CC...-09T3..	LW3	12x12	6	20	LW3-SCMCN-12-0020-09-JET
	LW4	16x16	8	25	LW4-SCMCN-16-0025-09-JET

Pièces de rechange Ersatzteile Spare parts	Plaquettes WSP Inserts	LW				
			Art. N°	Art. N°	Art. N°	Art. N°
CC...-0602..	LW3	V-M2.5X7.8-T8	C-T8	LWX-ER1.007.002	LW3-U00.ER1.000	
	LW4				LW4-U00.ER1.000	
CC...-09T3..	LW3	V-M4X9-T15-ISO	C-T15	LWX-ER1.007.002	LW3-U00.ER1.000	
	LW4				LW4-U00.ER1.000	

SWITCH-LINE

Têtes interchangeables
Wechselköpfe
Interchangeable heads

ISO-Line 55°

LW-SDJ-JET

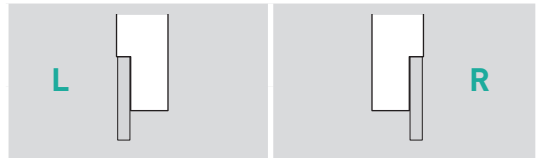
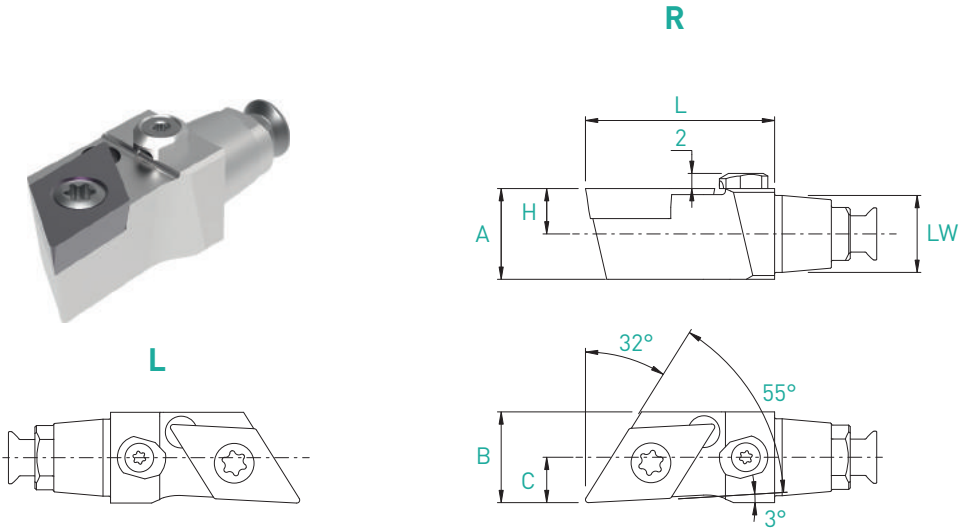

Plaquettes WSP Inserts	LW	A x B	H	C	L	Art. N°	
						Art. N°	Art. N°
DC...-0702..	LW3	12x12	6	6	20	LW3-SDJCL-12-0620-07-JET	LW3-SDJCR-12-0620-07-JET
	LW4	16x16	8	8	25	LW4-SDJCL-16-0825-07-JET	LW4-SDJCR-16-0825-07-JET
DC...-11T3..	LW3	12x12	6	6	25	LW3-SDJCL-12-0625-11-JET	LW3-SDJCR-12-0625-11-JET
	LW4	16x16	8	8	25	LW4-SDJCL-16-0825-11-JET	LW4-SDJCR-16-0825-11-JET

Pièces de rechange Ersatzteile Spare parts	Plaquettes WSP Inserts	LW	Art. N°			
			Art. N°	Art. N°	Art. N°	Art. N°
DC...-0702..	LW3	V-M2.5X7.8-T8	C-T8	LWX-ER1.007.002	LW3-U00.ER1.000	
	LW4				LW4-U00.ER1.000	
DC...-11T3..	LW3	V-M4X9-T15-ISO	C-T15	LWX-ER1.007.002	LW3-U00.ER1.000	
	LW4				LW4-U00.ER1.000	

Têtes interchangeables

Wechselköpfe



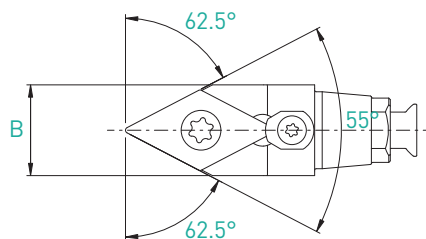
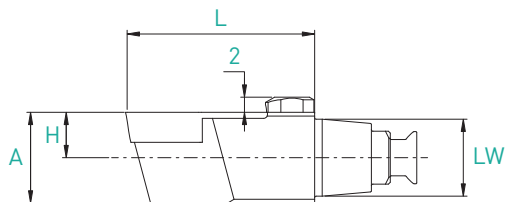

Interchangeable heads

ISO-Line 55°

LW-SDN-JET

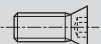

Plaquettes WSP Inserts	LW	A x B	H	L	Art. N°
DC..-0702	LW3	12x12	6	20	LW3-SDNCN-12-0020-07-JET
	LW4	16x16	8	25	LW4-SDNCN-16-0025-07-JET
DC..-11T3	LW3	12x12	6	25	LW3-SDNCN-12-0025-11-JET
	LW4	16x16	8	25	LW4-SDNCN-16-0025-11-JET

Pièces de rechange Ersatzteile Spare parts	Plaquettes WSP Inserts	LW				
			Art. N°	Art. N°	Art. N°	Art. N°
DC..-0702	LW3	V-M2.5X7.8-T8	C-T8	LWX-ER1.007.002	LW3-U00.ER1.000	
	LW4				LW4-U00.ER1.000	
DC..-11T3	LW3	V-M4X9-T15-ISO	C-T15	LWX-ER1.007.002	LW3-U00.ER1.000	
	LW4				LW4-U00.ER1.000	

SWITCH-LINE

Têtes interchangeables
Wechselköpfe
Interchangeable heads

ISO-Line 55°

LW-SDH-JET

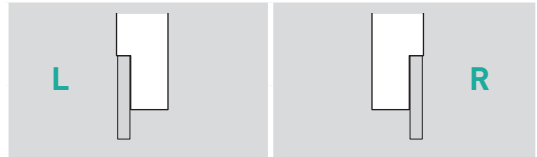
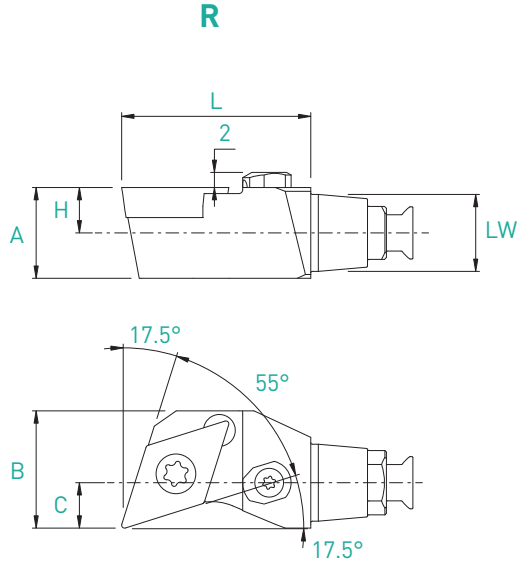
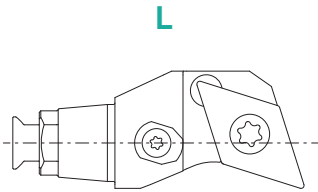

Plaquettes WSP Inserts	LW	A x B	H	C	L	Art. N°	
						Art. N°	Art. N°
DC...-0702..	LW3	12x15.5	6	6	20	LW3-SDHCL-12-0620-07-JET	LW3-SDHCR-12-0620-07-JET
	LW4	16x16	8	8	25	LW4-SDHCL-16-0825-07-JET	LW4-SDHCR-16-0825-07-JET
DC...-11T3..	LW3	12x15.5	6	6	25	LW3-SDHCL-12-0625-11-JET	LW3-SDHCR-12-0625-11-JET
	LW4	16x16	8	8	25	LW4-SDHCL-16-0825-11-JET	LW4-SDHCR-16-0825-11-JET

Pièces de rechange Ersatzteile Spare parts	Plaquettes WSP Inserts	LW	Art. N°	Art. N°	Art. N°	Art. N°			
			Art. N°	Art. N°	Art. N°	Art. N°			
DC...-0702..	LW3	LW4	V-M2.5X7.8-T8	C-T8	LWX-ER1.007.002	LW3-U00.ER1.000			
						LW4-U00.ER1.000			
	LW3	LW4				V-M4X9-T15-ISO	C-T15	LWX-ER1.007.002	LW3-U00.ER1.000
									LW4-U00.ER1.000

Têtes interchangeables

Wechselköpfe

Interchangeable heads

ISO-Line

35°

LW-SVJ-JET



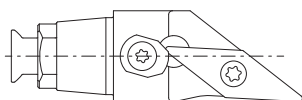

L

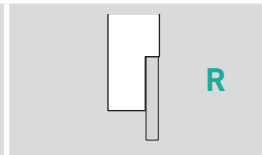
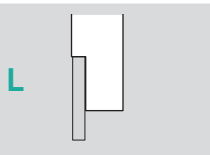
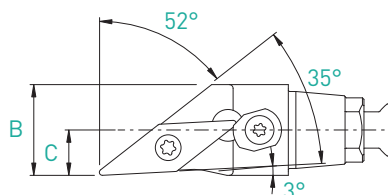
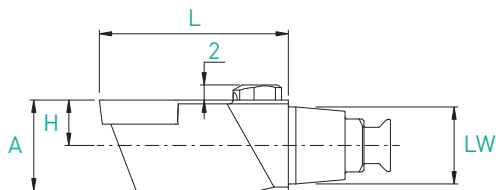

R

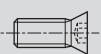
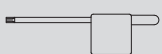

Plaquettes WSP Inserts	LW	A x B	H	C	L	Art. N°	Art. N°
VC...-1103..	LW3	12x12	6	6	25	LW3-SVJCL-12-0625-11-JET	LW3-SVJCR-12-0625-11-JET
	LW4	16x16	8	8	25	LW4-SVJCL-16-0825-11-JET	LW4-SVJCR-16-0825-11-JET
VC...-1303..	LW3	12x12	6	6	30	LW3-SVJCL-12-0630-13-JET	LW3-SVJCR-12-0630-13-JET
	LW4	16x16	8	8	30	LW4-SVJCL-16-0830-13-JET	LW4-SVJCR-16-0830-13-JET
VC...-1604..	LW4	16x16	8	8	35	LW4-SVJCL-16-0835-16-JET	LW4-SVJCR-16-0835-16-JET

Pièces de rechange Ersatzteile Spare parts	Plaquettes WSP Inserts	LW				
			Art. N°	Art. N°	Art. N°	Art. N°
VC...-1103..	LW3	V-M2.5X7.8-T8	C-T8	LWX-ER1.007.002	LW3-U00.ER1.000	
	LW4				LW4-U00.ER1.000	
VC...-1303..	LW3	V-M4X9-T15-ISO	C-T15	LWX-ER1.007.002	LW3-U00.ER1.000	
	LW4				LW4-U00.ER1.000	
VC...-1604..	LW4	V-M4X9-T15-ISO	C-T15	LWX-ER1.007.002	LW4-U00.ER1.000	



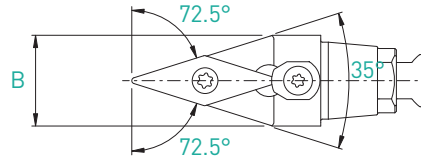
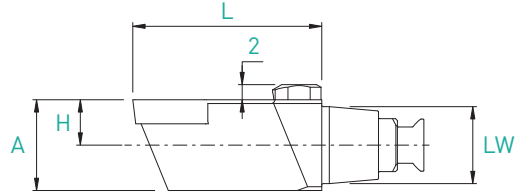
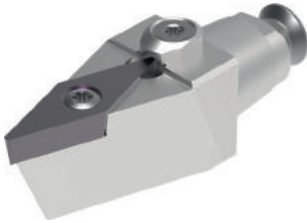

Têtes interchangeables
Wechselköpfe
Interchangeable heads

ISO-Line 35°

LW-SVV-JET

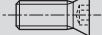

Plaquettes WSP Inserts	LW	A x B	H	L	Art. N°
VC..-1103..	LW3	12x12	6	25	LW3-SVVCN-12-0025-11-JET
	LW4	16x16	8	25	LW4-SVVCN-16-0025-11-JET
VC..-1303..	LW3	12x12	6	30	LW3-SVVCN-12-0030-13-JET
	LW4	16x16	8	30	LW4-SVVCN-16-0030-13-JET
VC..-1604..	LW4	16x16	8	35	LW4-SVVCN-16-0035-16-JET

Pièces de rechange Ersatzteile Spare parts	Plaquettes WSP Inserts	LW				
			Art. N°	Art. N°	Art. N°	Art. N°
VC..-1103..	LW3	LW4	V-M2.5X7.8-T8	C-T8	LWX-ER1.007.002	LW3-U00.ER1.000
	LW4					LW4-U00.ER1.000
VC..-1303..	LW3	LW4	V-M3X7.3-T8-ISO	C-T15	LWX-ER1.007.002	LW3-U00.ER1.000
	LW4					LW4-U00.ER1.000
VC..-1604..	LW4	LW4	V-M4X9-T15-ISO	C-T15	LWX-ER1.007.002	LW4-U00.ER1.000



Supports cylindriques

Zylindrische Halter

Cylinder holders

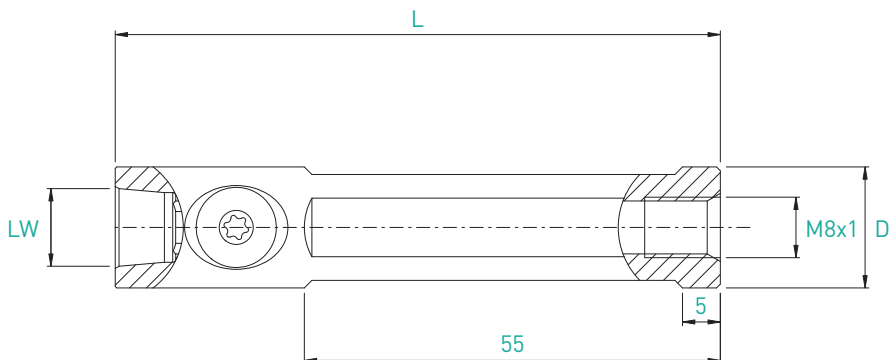
LW-D

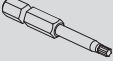

				Pièces rechanges Ersatzteile Spare parts		Options		
								
LW	D	L	L1	Art. N°	Art. N°	Art. N°	Art. N°	
LW3	16	80	55	LW3-D16-80-JET	LW3-ER1.012.014	JB-M8X1	CD-NM3.8	TX15-E6.3
LW4	19.05	80	55	LW4-D19.05-80-JET	LW4-ER1.014.018		CD-NM5.7	TX20-E6.3
	20	80	55	LW4-D20-80-JET	LW4-ER1.014.019			
	22	80	55	LW4-D22-80-JET	LW4-ER1.014.019			
	25	80	55	LW4-D25-80-JET	LW4-ER1.015.023			
	25.4	80	55	LW4-D25.4-80-JET	LW4-ER1.015.023			

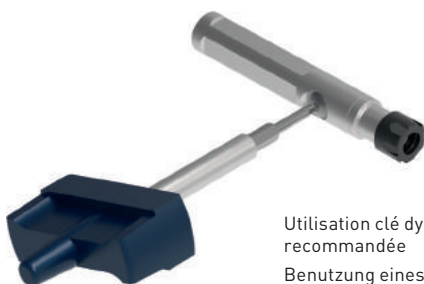

Utilisation clé dynamométrique recommandée
Benutzung eines Drehmomentschlüssel empfohlen
Recommended use of dynamometric key

Options raccords	
	Art. N°
	M8X1 voir JET-LINE siehe JET-LINE see JET-LINE

SWITCH-LINE

Têtes interchangeables porte-pince
 Spannzangenwechselköpfe
 Interchangeable heads gripper holder

LW-E

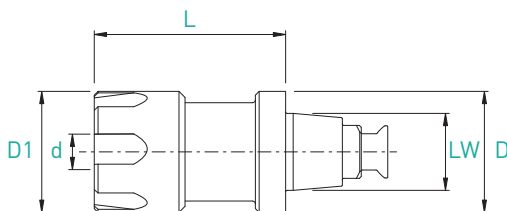

Pièces rechanges
 Ersatzteile
 Spare parts



LW	D	D1	L	Pince type	d	Art. N°	Art. N°	Art. N°
LW3	16	16	26	ER11	0.5-7	LW3-E11-D16-26	E11-ER1.001-012	LW3-U00.ER1.00
LW4	19	16	26	ER11	0.5-7	LW4-E11-D19-26		LW4-U00.ER1.00
	19	22	35	ER16	0.5-10	LW4-E16-D19-35	E16-ER1.001-018	

Porte-outils

Halter

Holders

HSK-40-LW3

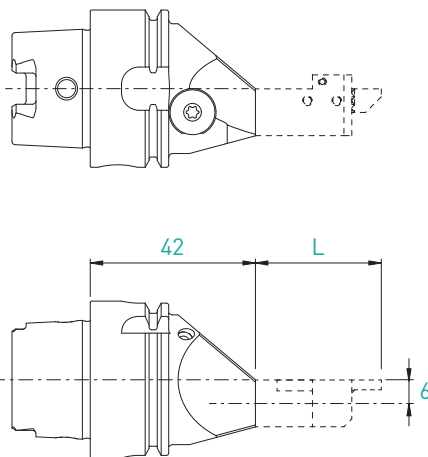

BUMOTEC S191

LW	Compatibility	Page	L	Art. N°	Art. N°
LW3	LW3-740..	11.06	32	HSK-T40-LW3-0642-JET	HSK-A40-LW3-0642-JET-BU**
	LW3-760..	11.07	43		
	LW3-320-340..	11.09/11.11	20		
	LW3-SCLCR..	11.12	20		
	LW3-SCMCN..	11.13	20		
	LW3-SDJCR..	11.14	20		
	LW3-SDNCN..	11.15	20		
	LW3-SDHCR..	11.16	20		
LW3-SVJCR..	11.17	25			

** Pour machines Bumotec

Pièces rechanges Ersatzteile Spare parts	Options	
Art. N°	Art. N°	Art. N°
LW3-ER1.012.014	CD-NM3.8	C-TX15-E6.3



Système d'outils modulaires

Modulares Werkzeugsystem

Modular tooling system

Original system

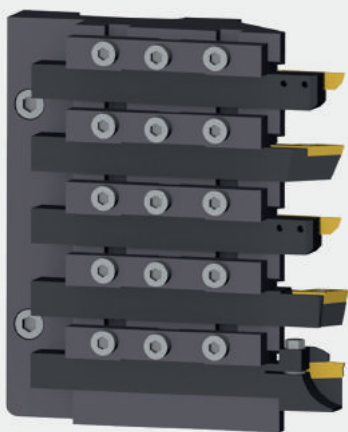

MODU-Line system

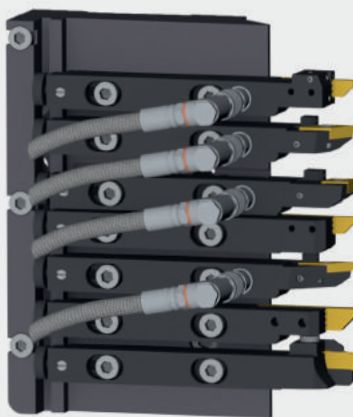

Système d'outils modulaires
pour tours automatiques

Modulares Werkzeugsystem
für Langdrehautomaten

Modular tooling system for
sliding headstock automatic lathes

Les avantages

Die Vorteile

The advantages

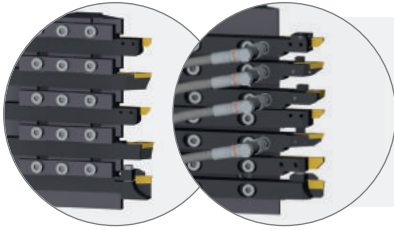

Plus d'outils disponibles
Höhere Werkzeuganzahl
More available tools

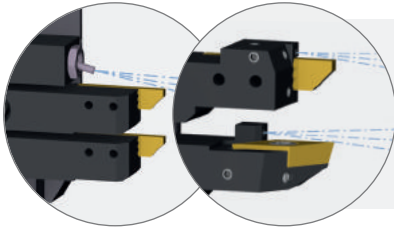

Système d'arrosage efficace
Effizientes Kühlmittelzufuhrsystem
Efficient coolant supply system

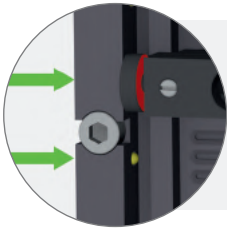

Repositionnement précis, poussée axiale automatique
Präzise Nachpositionierung, automatischer Axialschub
Precise repositioning, automatic axial thrust

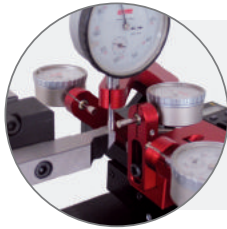

Possibilité de pré réglage et de réglage de la longueur des outils
Voreinstellbar auf feste oder einstellbare Länge
Presetting on fixed or adjustable length

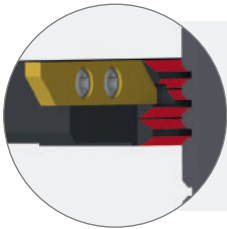

Système de fixation robuste et rigide
Robustes und starres Spannsystem
Strong and stable clamping system

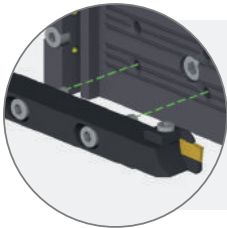

Changement d'outil simple et rapide
Einfacher und schneller Werkzeugwechsel
Easy and quick tool replacement

Adaptations disponibles pour les machines suivantes:
 Verfügbare Anpassungen für folgende Maschinen:
 Available adapters for the following machines:

**Citizen - Hanwha -
 Manurhin - Metafil - > 12.06
 Star - Tornos - Tsugami**

Porte-outils
 Halter
 Holders

INFO > 12.60

ML12



ML16



Right cut

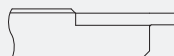

TOP-Line > 12.64

TURN-Line > 12.65

ISO-Line > 12.66

EVOCUT-Line > 12.68

CUT-Line > 12.69

PRO-Line > 12.70

ECO-Line > 12.70

IN-Line > 12.71

TOOLING-Line > 12.73

Cut off line



TOP-Line > 12.74

TURN-Line > 12.76

ISO-Line > 12.77

EVOCUT-Line > 12.78

CUT-Line > 12.79

PRO-Line > 12.80

ECO-Line > 12.81

Modules d'arrosage et de serrage
 Kühlmittelzufuhr- und Spannelemente
 Coolant and clamping supply unit

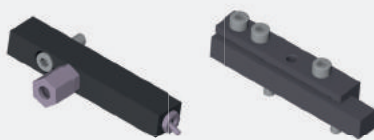

> 12.82

Banc de pré réglage
 Voreinstellgerät
 Presetting device

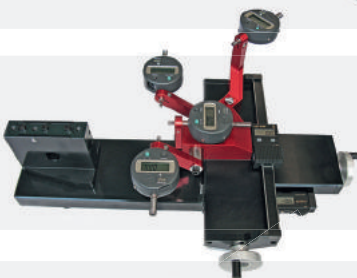

> 12.84

Pièces de rechange
 Ersatzteile
 Spare parts





> 12.86

Adaptations disponibles pour les machines suivantes

Verfügbare Anpassungen für folgende Maschinen

Available adapters for the following machines

Fabricant Hersteller Manufacturer	Machine Maschine Machine	Adaptations Anpassungen Adapters	Type Typ Type	Page Seite Page	
Citizen	C12/C16	ML12-CITIZEN-C16	ML12	12.06	
	L12-1M7	ML12-CITIZEN-L12-1M7		12.07	
	L12-2M10	ML12-CITIZEN-L12-2M10		12.08	
	M16V/VIII	ML12-CITIZEN-M16V/VIII		12.09	
	R04			ML12-CITIZEN-R04-QTF3101-3T	12.12
				ML12-CITIZEN-R04-QTF5008-4T	12.10
				ML12-CITIZEN-R04-QTF5108-4T	
	R07			ML12-CITIZEN-R07-QTF4008-5T	12.13
				ML12-CITIZEN-R07-QTF4108-6T	
				ML12-CITIZEN-R07-QTF4208-3T	
				ML12-CITIZEN-R07-QTF4608-4T	
	K12/K16	ML16-CITIZEN-K16		ML16	12.15
L16/L20-5M1/5M7	ML16-CITIZEN-L20	12.16			
L20E-1M8/L20X-1M10/ L20-2M8/2M12	ML16-CITIZEN-L20E		12.17		
Hanwha	XD20M	ML12-HANWHA-XD20M	ML12	12.18	
	SL12/16	ML16-HANWHA-SL12/16	ML16	12.19	
Manuhrin	KMX 426/526/626/ Swingg 20-26 MM	ML16-KMX26-DUO	ML16	12.20	
		ML16-KMX26-JET			
Metafil	D3/D10/D13	ML12-D10-3T	ML12	12.21	
Star	SB-12RG	ML12-STAR-SB-12RG	ML12	12.22	
	SR-10J	ML12-STAR-SR-10J		12.23	
	SW-12RII	ML12-STAR-SW-12RII-2T		12.24	
		ML12-STAR-SW-12RII-8T			
	SA-12/SA-16/SA-16R	ML16-STAR-SA-16	ML16	12.25	
	SB-16	ML16-STAR-SB-16		12.26	
	SB-16/20RG	ML16-STAR-SB-16/20RG		12.27	
	SB-20C/E	ML16-STAR-SB-20		12.28	
	SR-16R/SR-20R/SR-20RII	ML16-STAR-SR-20R		12.29	
	SR-20J/SR-20RIII	ML16-STAR-SR-20J		12.30	
	SR-20JII-A/B	ML16-STAR-SR-20JII-A/B 		12.31	
	SR-20RIV	ML16-STAR-SR-20RIV-2T		12.32	
		ML16-STAR-SR-20RIV-6T			
	SR-32J	ML16-STAR-SR-32J		12.33	
	SV-12/20	ML16-STAR-SV-12/20 		12.35	
	SV-20R	ML16-STAR-SV-20R		12.35	
	SW-20R	ML16-STAR-SW-20R-2T		12.36	
ML16-STAR-SW-20R-6T					

Adaptations disponibles pour les machines suivantes

Verfügbare Anpassungen für folgende Maschinen

Available adapters for the following machines

Fabricant Hersteller Manufacturer	Machine Maschine Machine	Adaptations Anpassungen Adapters	Type Typ Type	Page Seite Page
Tornos	DEC07/10 - EvoDECO 10	ML12-DEC010-DUO	ML12	12.37
		ML12-DEC010-JET		
	SWISS-NANO /SWISS-NANO 7	ML12-SWISS-NANO-2T		12.40
		ML12-SWISS-NANO-3T		
		ML12-SWISS-NANO-6T		
	SWISS-NANO 7	ML12-SWISS-NANO-4T		12.38
	DT13	ML12-DT13-2020206-9T		12.41
	CT20	ML12-CT20-2020019-7T		12.42
	GT13	ML12-GT13-390224-5T		12.43
		ML12-GT13-390223-7T		
	GT26	ML16-GT26-386210-5T		12.44
		ML16-GT26-386209-6T		
	GT32	ML16-GT32-389210-4T		12.46
		ML16-GT32-389209-5T		
	DEC013- EvoDECO16	ML16-DEC013-DUO		12.48
ML16-DEC013-JET				
DEC020/26 - EvoDECO20/32	ML16-DEC020-DUO	12.50		
	ML16-DEC020-JET			
SIGMA20/32	ML16-S20-DUO	12.51		
	ML16-S20-JET			
SWISS ST26	ML16-SWISS-ST26-DUO	12.52		
	ML16-SWISS-ST26-JET			
DT26	ML16-DT26-2020206-7T	12.53		
Tsugami	B074	ML12-B074-1-6T	ML12	12.54
	B075	ML12-B075-1-8T		12.55
	PO34	ML12-PO34-1-5T		12.56
		ML12-PO34-1-7T		
		ML12-PO34-2-4T		
		ML12-PO34-2-10T		

Citizen C12 / C16

+ 2 outils (max 8)
 + 2 Werkzeuge (max 8)
 + 2 tools (max 8)

ML12

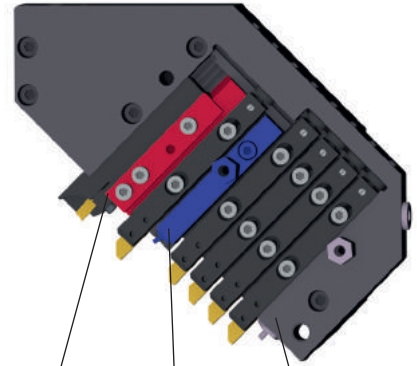
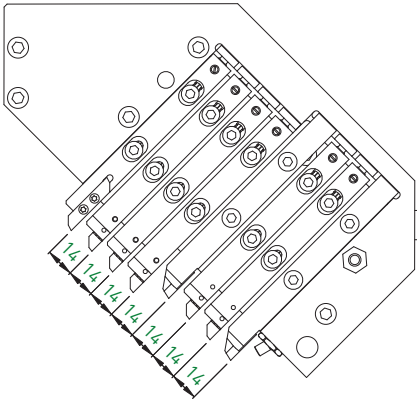

Outil \square 12 mm possible avec module de serrage
 Werkzeug \square 12 mm mit Spannelement möglich
 Tool \square 12mm possible with clamping unit

Module d'arrosage (prend la place d'un outil)
 Kühlmittelzufuhrelement (nimmt den Platz eines Werkzeuges)
 Coolant supply unit (takes the place of one tool)

Arrosage intégré
 Integrierter Kühlmittel
 Integrated coolant

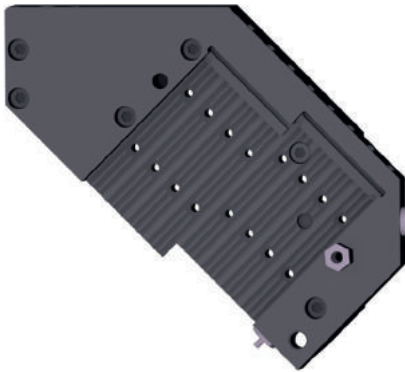

			Accessoires Zubehöre Accessories		
Art. N°	Porte-outils Halter Holders	Pages Seiten Pages	Module de serrage Spannelement Clamping unit	Module d'arrosage Kühlmittelzufuhrelement Coolant supply unit	Page Seite Page
ML12-CITIZEN-C16	ML12	> 12.63	ML12-FIX-12/14	ML12-JET-5/16	12.82

Citizen L12-1M7

- + 2 outils (max 8)
- + 2 Werkzeuge (max 8)
- + 2 tools (max 8)

ML12

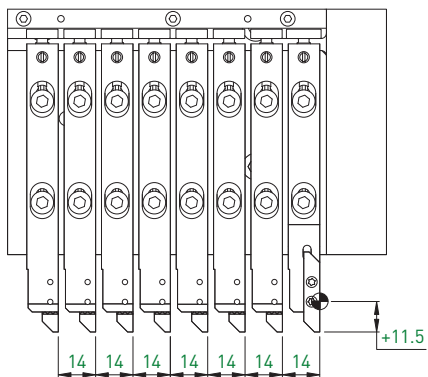

Accessoires
Zubehöre
Accessories

Art. N°	Porte-outils Halter Holders	Pages Seiten Pages	Module de serrage Spannelement Clamping unit	Module d'arrosage Kühlmittelzufuhrelement Coolant supply unit	Page Seite Page
ML12-CITIZEN-L12-1M7	ML12	> 12.63	-	ML12-JET-5/16	12.82

Citizen L12-2M10

- + 3 outils (max 10)
- + 3 Werkzeuge (max 10)
- + 3 tools (max 10)

ML12

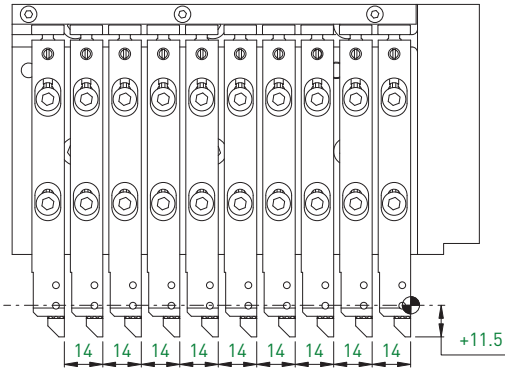

Accessoires
Zubehöre
Accessories

Art. N°	Porte-outils Halter Holders	Pages Seiten Pages	Module de serrage Spannelement Clamping unit	Module d'arrosage Kühlmittelzufuhrelement Coolant supply unit	Page Seite Page
ML12-CITIZEN-L12-2M10	ML12	> 12.63	-	ML12-JET-5/16	12.82

Citizen M16 V/VIII

- + 2 outils (max 7)
- + 2 Werkzeuge (max 7)
- + 2 tools (max 7)

ML12

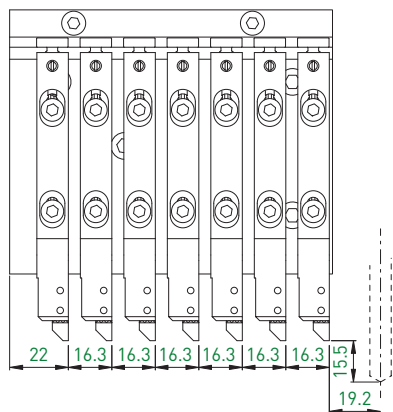

Accessoires
Zubehöre
Accessories

Art. N°	Porte-outils Halter Holders	Pages Seiten Pages	Module de serrage Spannelement Clamping unit	Module d'arrosage Kühlmittelzufuhrelement Coolant supply unit	Page Seite Page
ML12-CITIZEN-M16V/VIII	ML12	> 12.63	-	ML12-JET-5/16	12.82

Citizen R04

- + 1 outil (max 8)
- + 1 Werkzeug (max 8)
- + 1 tool (max 8)

ML12

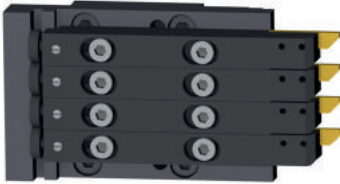
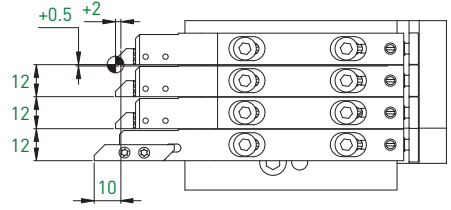
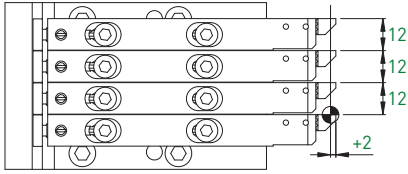

ML12-CITIZEN-R04-QTF5008-4T

ML12-CITIZEN-R04-QTF5108-4T

Type Typ Type	Art. N°	Porte-outils Halter Holders	Pages Seiten Pages	Accessoires Zubehöre Accessories		
				Module de serrage Spannelement Clamping unit	Module d'arrosage Kühlmittelzufuhrelement Coolant supply unit	Page Seite Page
4T	ML12-CITIZEN-R04-QTF5008-4T ML12-CITIZEN-R04-QTF5108-4T	ML12	> 12.63	-	ML12-JET-5/16	12.82

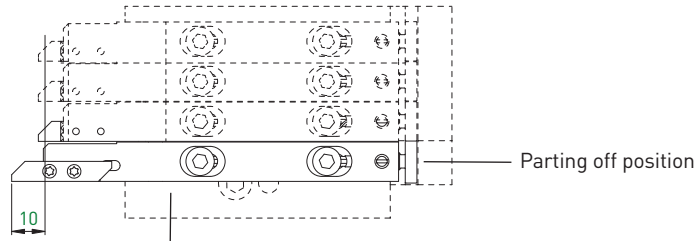

ML12-CITIZEN-R04-QTF5108-4T

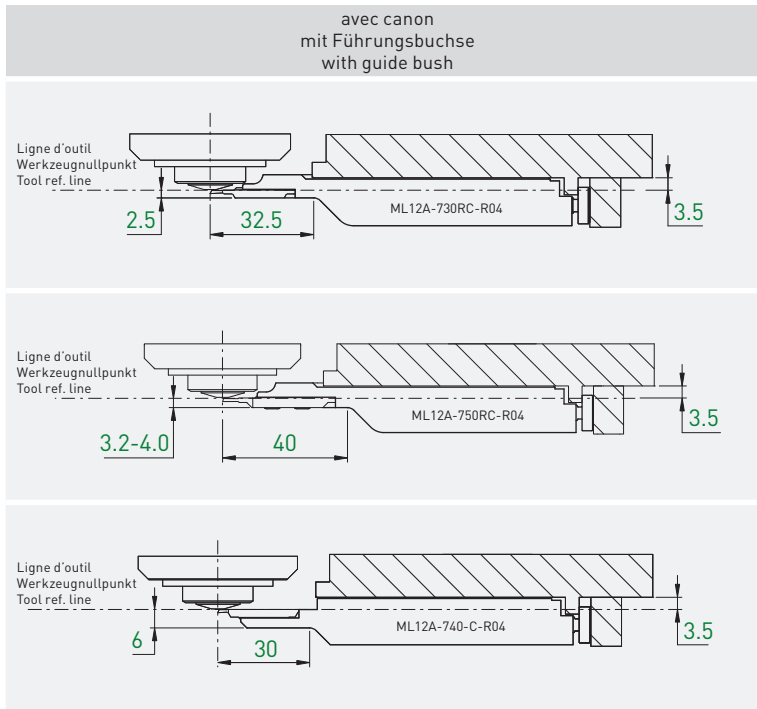

Type de machine Maschinen-Typ Type of machine	Porte-outils Halter Holders	Art. N°	Plaquettes Wendplatten Inserts	Pages Seiten Pages
Citizen R04	ML12	ML12A-730RC-R04	731R... / 731RSF	> TOP-Line TOP-Watch
		ML12A-750RC-R04	751R... / 751RDSF	
		ML12A-740-C-R04	741 / 741SF	

Citizen R04

- + 3 outils (max 3)
- + 3 Werkzeuge (max 3)
- + 3 tools (max 3)

ML12

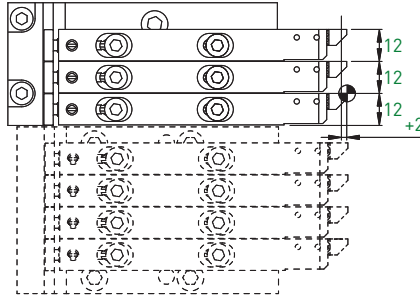

Accessoires
Zubehöre
Accessories

Art. N°	Porte-outils Halter Holders	Pages Seiten Pages	Module de serrage Spannelement Clamping unit	Module d'arrosage Kühlmittelezufuhrelement Coolant supply unit	Page Seite Page
ML12-CITIZEN-R04-QTF3101-3T	ML12	> 12.63	-	ML12-JET-5/16	12.82

Citizen R07

- + 1 outil (max 11)
- + 1 Werkzeug (max 11)
- + 1 tool (max 11)

ML12

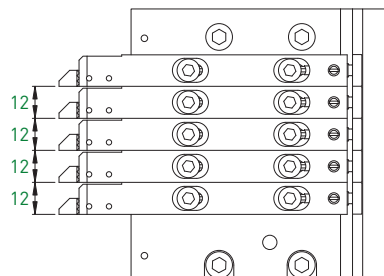
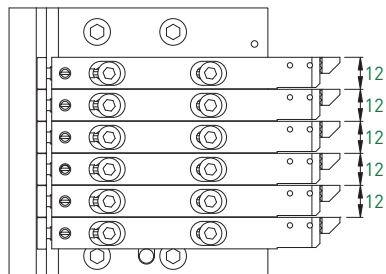

ML12-CITIZEN-R07-QTF4108-6T

ML12-CITIZEN-R07-QTF4008-5T

Type Typ Type	Art. N°	Porte-outils Halter Holders	Pages Seiten Pages	Module de serrage Spannelement Clamping unit	Module d'arrosage Kühlmittelzufuhrelement Coolant supply unit	Page Seite Page
5T	ML12-CITIZEN-R07-QTF4008-5T	ML12	> 12.63	-	ML12-JET-5/16	12.82
6T	ML12-CITIZEN-R07-QTF4108-6T					

Accessoires
Zubehöre
Accessories

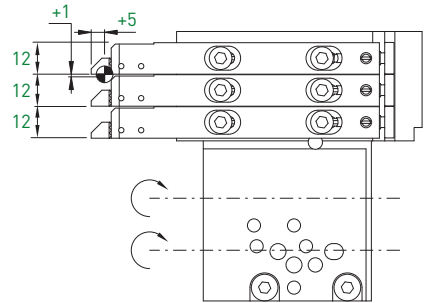
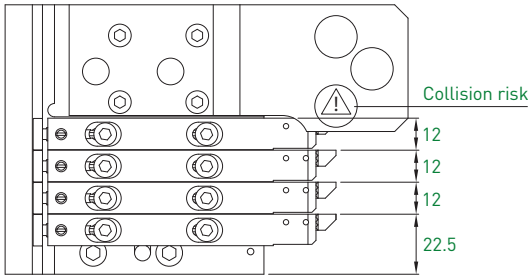

ML12-CITIZEN-R07-QTF4608-4T

ML12-CITIZEN-R07-QTF4208-3T

Type Typ Type	Art. N°	Porte-outils Halter Holders	Pages Seiten Pages	Module de serrage Spannelement Clamping unit	Accessoires Zubehöre Accessories	Page Seite Page
3T	ML12-CITIZEN-R07-QTF4208-3T	ML12	> 12.63	-	Module d'arrosage Kühlmittelzufuhrelement Coolant supply unit	ML12-JET-5/16
4T	ML12-CITIZEN-R07-QTF4608-4T					

Citizen K12 / K16
K12E / K16E

+ 2 outils (max 8)
+ 2 Werkzeuge (max 8)
+ 2 tools (max 8)

ML16

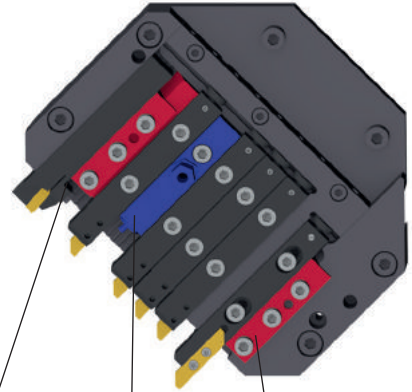
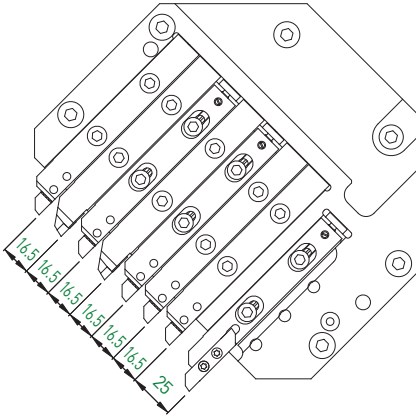

Outil \square 16 mm possible avec module de serrage
Werkzeug \square 16 mm mit Spannelement möglich
Tool \square 16 mm possible with clamping unit

Module d'arrosage (prend la place d'un outil)
Kühlmittelzufuhrelement (nimmt den Platz eines Werkzeuges)
Coolant supply unit (takes the place of one tool)

1 serrage ML16-FIX-16 pour outil \square 16 mm inclus
1 Spannung ML16-FIX-16 für Werkzeug \square 16 mm inbegriffen
1 clamping ML16-FIX-16 for tool \square 16 mm included

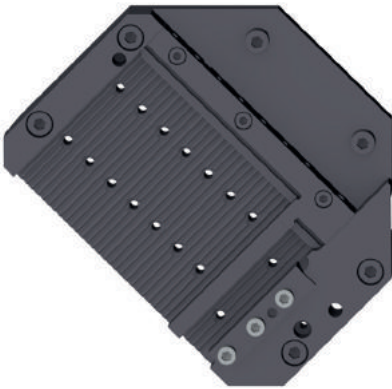

Accessoires
Zubehöre
Accessories

Art. N°	Porte-outils Halter Holders	Pages Seiten Pages	Module de serrage Spannelement Clamping unit	Module d'arrosage Kühlmittelzufuhrelement Coolant supply unit	Page Seite Page
ML16-CITIZEN-K16	ML16	> 12.63	ML16-FIX-16/16.5	ML16-JET-7/16	12.82

Citizen L16 / L20-5M1 / 5M7

- + 1 outil (max 7)
- + 1 Werkzeug (max 7)
- + 1 tool (max 7)

ML16

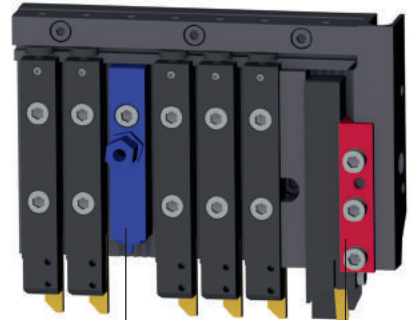
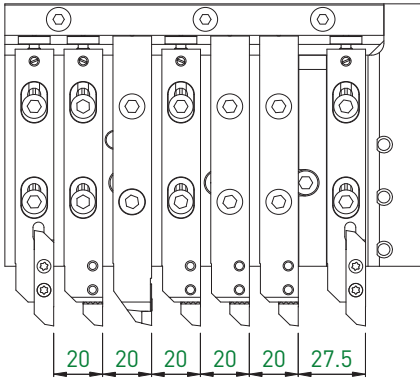

Module d'arrosage (prend la place d'un outil)
 Kühlmittelzufuhrelement (nimmt den Platz eines Werkzeuges)
 Coolant supply unit (takes the place of one tool)

- 1 serrage ML16-FIX-16 pour outil \varnothing 16 mm inclus
- 1 Spannung ML16-FIX-16 für Werkzeug \varnothing 16 mm inbegriffen
- 1 clamping ML16-FIX-16 for tool \varnothing 16 mm included



Accessoires
 Zubehör
 Accessories

Art. N°	Porte-outils Halter Holders	Pages Seiten Pages	Module de serrage Spannelement Clamping unit	Module d'arrosage Kühlmittelzufuhrelement Coolant supply unit	Page Seite Page
ML16-CITIZEN-L20	ML16	> 12.63	-	ML16-JET-7/16	12.82

- L20E-1M8** + 1 outil (max 6)
- Citizen L20X-1M10** + 1 Werkzeug (max 6)
- L20-2M8/2M12** + 1 tool (max 6)

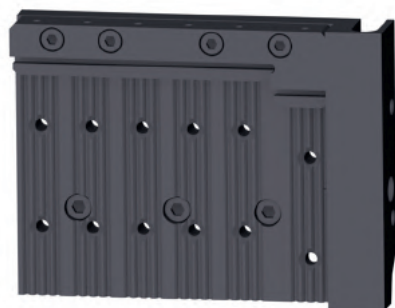
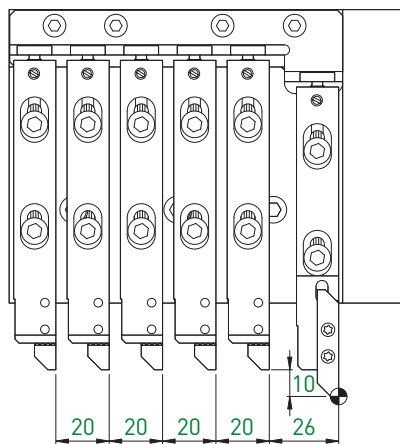

Accessoires
Zubehöre
Accessories

Art. N°	Porte-outils Halter Holders	Pages Seiten Pages	Module de serrage Spannelement Clamping unit	Module d'arrosage Kühlmitelzufuhrelement Coolant supply unit	Page Seite Page
ML16-CITIZEN-L20E	ML16	> 12.63	-	ML16-JET-7/16	12.82

Hanwha XD20M

+ 2 outils (max 7)
 + 2 Werkzeuge (max 7)
 + 2 tools (max 7)

ML12

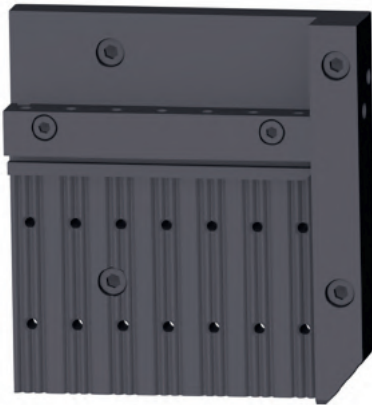
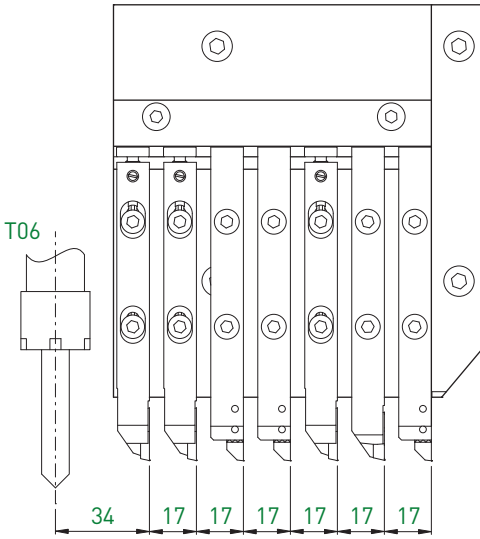

Accessoires
 Zubehöre
 Accessories

Art. N°	Porte-outils Halter Holders	Pages Seiten Pages	Module de serrage Spannelement Clamping unit	Module d'arrosage Kühlmittelzufuhrelement Coolant supply unit	Page Seite Page
ML12-HANWHA-XD20M	ML12	> 12.63	-	ML12-JET-5/16	12.82

Hanwha SL12 / 16

- + 1 outil (max 7)
- + 1 Werkzeug (max 7)
- + 1 tool (max 7)

ML16

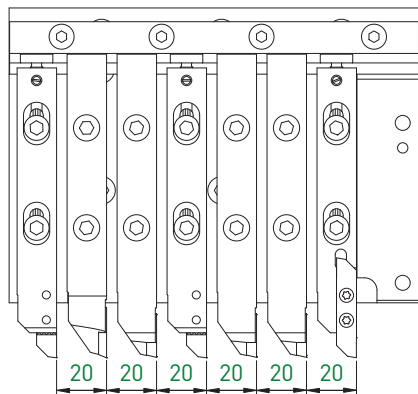

Accessoires
Zubehöre
Accessories

Art. N°	Porte-outils Halter Holders	Pages Seiten Pages	Module de serrage Spannelement Clamping unit	Module d'arrosage Kühlmitelzufuhrelement Coolant supply unit	Page Seite Page
ML16-HANWHA-SL12/16	ML16	> 12.63	-	ML16-JET-7/16	12.82

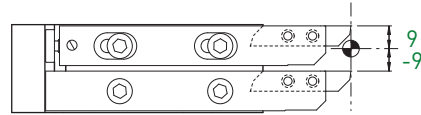
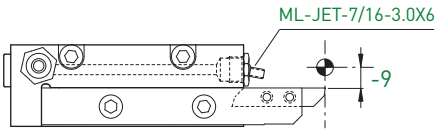
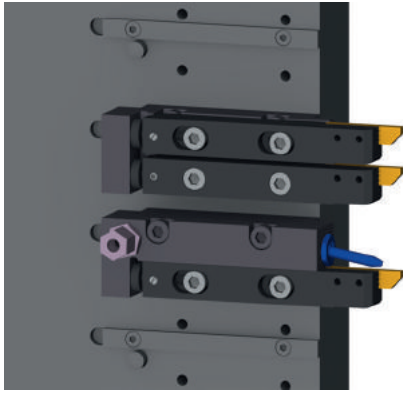

Jet



Duo

Accessoires
Zubehöre
Accessories

Type Typ Type	Art. N°	Porte-outils Halter Holders	Pages Seiten Pages	Module de serrage Spannelement Clamping unit	Module d'arrosage Kühlmittelzufuhrelement Coolant supply unit	Page Seite Page
Jet	ML16-KMX26-JET	ML16	> 12.63	-	ML-JET-7/16...	12.82
Duo	ML16-KMX26-DUO				ML16-JET-7/16	

D3	+ 1 outil (max 3)	ML12
Metafil D10	+ 1 Werkzeug (max 3)	
D13	+ 1 tool (max 3)	

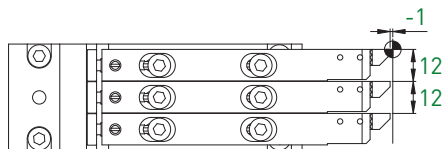

Accessoires
Zubehöre
Accessories

Art. N°	Porte-outils Halter Holders	Pages Seiten Pages	Module de serrage Spannelement Clamping unit	Module d'arrosage Kühlmittelzufuhrelement Coolant supply unit	Page Seite Page
ML12-D10-3T	ML12	> 12.63	-	ML12-JET-5/16	12.82

Star SB-12RG

- + 2 outils (max 9)
- + 2 Werkzeuge (max 9)
- + 2 tools (max 9)

ML12

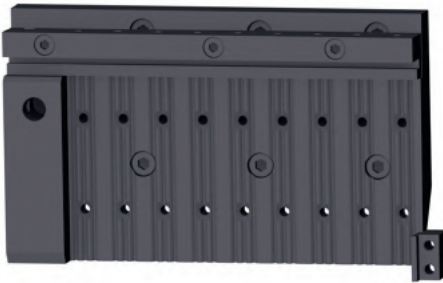
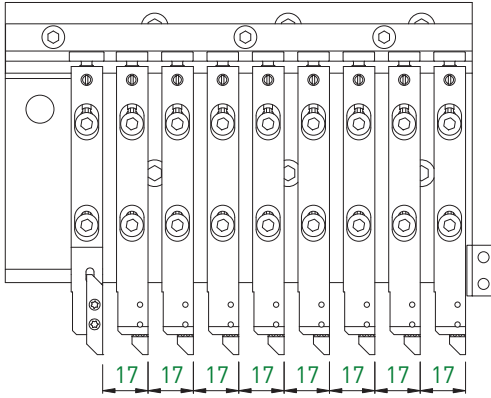

Accessoires
Zubehöre
Accessories

Art. N°	Porte-outils Halter Holders	Pages Seiten Pages	Module de serrage Spannelement Clamping unit	Module d'arrosage Kühlmittelzufuhrelement Coolant supply unit	Page Seite Page
ML12-STAR-SB-12RG	ML12	> 12.63	-	ML12-JET-5/16	12.82

Star SR-10J

- + 2 outils (max 8)
- + 2 Werkzeuge (max 8)
- + 2 tools (max 8)

ML12

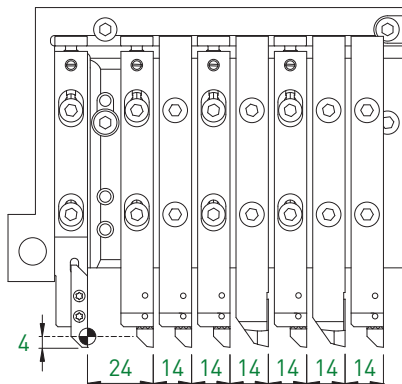

- 1 serrage ML12-FIX-12 pour outil \square 12 mm inclus
- 1 Spannung ML12-FIX-12 für Werkzeug \square 12 mm inbegriffen
- 1 clamping ML12-FIX-12 for tool \square 12 mm included

Module d'arrosage (prend la place d'un outil)
 Kühlmittelzufuhrelement (nimmt den Platz eines Werkzeuges)
 Coolant supply unit (takes the place of one tool)



Accessoires
 Zubehör
 Accessories

Art. N°	Porte-outils Halter Holders	Pages Seiten Pages	Module de serrage Spannelement Clamping unit	Module d'arrosage Kühlmittelzufuhrelement Coolant supply unit	Page Seite Page
ML12-STAR-SR-10J	ML12	> 12.63	ML12-FIX-12/14	ML12-JET-5/16	12.82

Star SW-12RII

+ 2 outils (max 10)
 + 2 Werkzeuge (max 10)
 + 2 tools (max 10)

ML12

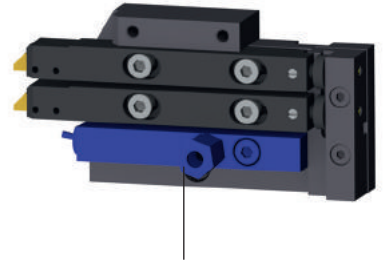
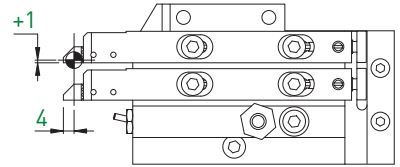
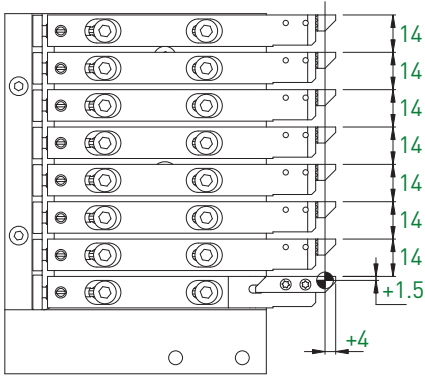

Position uniquement utilisable avec module d'arrosage, en option
 Position nur mit Kühlmittelzufuhrelement verwendbar, optional
 Position only with coolant supply unit usable, optional

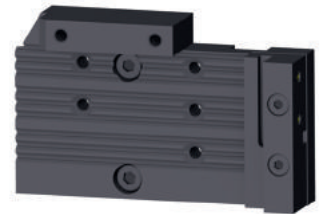

ML12-STAR-SW-12RII-8T

ML12-STAR-SW-12RII-2T

Accessoires
 Zubehör
 Accessories

Type Typ Type	Art. N°	Porte-outils Halter Holders	Pages Seiten Pages	Module de serrage Spannelement Clamping unit	Module d'arrosage Kühlmittelzufuhrelement Coolant supply unit	Page Seite Page
2T	ML12-STAR-SW-12RII-2T	ML12	> 12.63	-	ML12-JET-5/16	12.82
8T	ML12-STAR-SW-12RII-8T					

- SA-12 + 2 outils (max 8)
- Star SA-16 + 2 Werkzeuge (max 8)
- SA-16R + 2 tools (max 8)

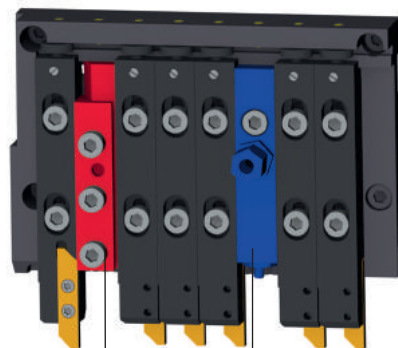
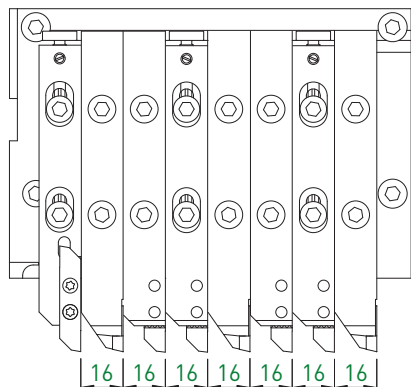

Outil 16 mm possible avec module de serrage
 Werkzeug 16 mm mit Spannelement möglich
 Tool 16 mm possible with clamping unit

Module d'arrosage (prend la place d'un outil)
 Kühlmittelzufuhrelement (nimmt den Platz eines Werkzeuges)
 Coolant supply unit (takes the place of one tool)

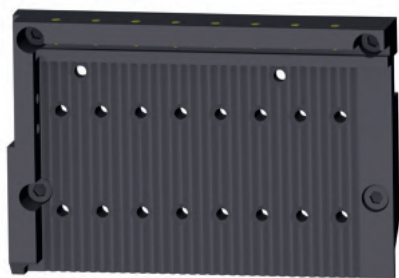

Accessoires
 Zubehör
 Accessories

Art. N°	Porte-outils Halter Holders	Pages Seiten Pages	Module de serrage Spannelement Clamping unit	Module d'arrosage Kühlmittelzufuhrelement Coolant supply unit	Page Seite Page
ML16-STAR-SA-16	ML16	> 12.63	ML16-FIX-16/16	ML16-JET-7/16	12.82

Star SB-16

- + 3 outils (max 8)
- + 3 Werkzeuge (max 8)
- + 3 tools (max 8)

ML16

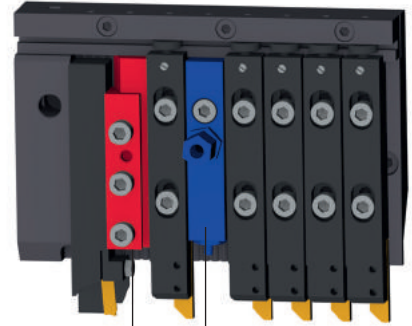
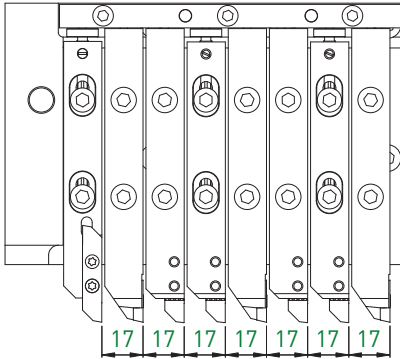

Outil \square 16 mm possible avec module de serrage
 Werkzeug \square 16 mm mit Spannelement möglich
 Tool \square 16 mm possible with clamping unit

Module d'arrosage (prend la place d'un outil)
 Kühlmittelzufuhrelement (nimmt den Platz eines Werkzeuges)
 Coolant supply unit (takes the place of one tool)



Accessoires
 Zubehöre
 Accessories

Art. N°	Porte-outils Halter Holders	Pages Seiten Pages	Module de serrage Spannelement Clamping unit	Module d'arrosage Kühlmittelzufuhrelement Coolant supply unit	Page Seite Page
ML16-STAR-SB-16	ML16	> 12.63	ML16-FIX-16/17	ML16-JET-7/16	12.82

Star SB-16/20RG

- + 1 outil (max 7)
- + 1 Werkzeug (max 7)
- + 1 tool (max 7)

ML16

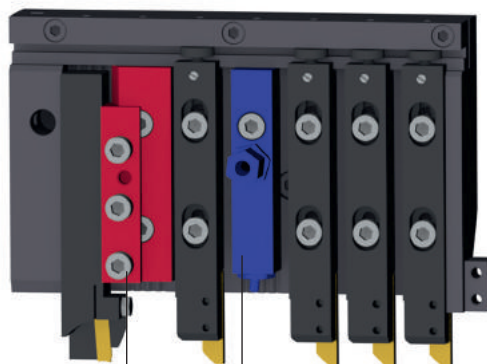
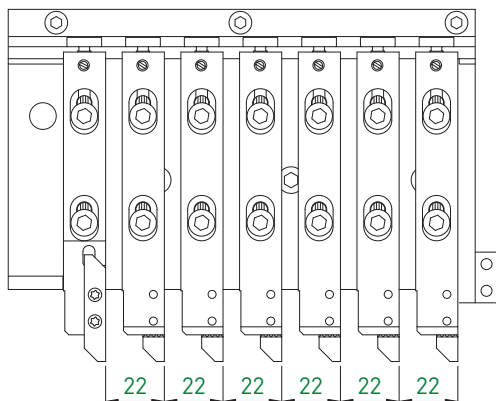

Outil \square 16 mm possible avec module de serrage
 Werkzeug \square 16 mm mit Spannelement möglich
 Tool \square 16 mm possible with clamping unit

Module d'arrosage (prend la place d'un outil)
 Kühlmittelzufuhrelement (nimmt den Platz eines Werkzeuges)
 Coolant supply unit (takes the place of one tool)

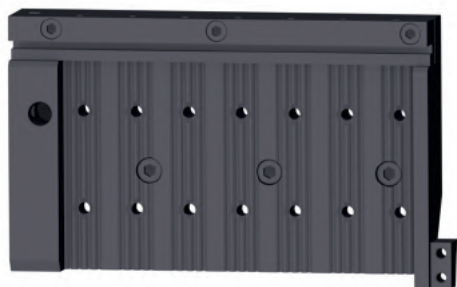

Accessoires
 Zubehör
 Accessories

Art. N°	Porte-outils Halter Holders	Pages Seiten Pages	Module de serrage Spannelement Clamping unit	Module d'arrosage Kühlmittelzufuhrelement Coolant supply unit	Page Seite Page
ML16-STAR-SB-16/20RG	ML16	> 12.63	ML16-FIX-16/22	ML16-JET-7/16	12.82

Star SB-20C/E

- + 1 outil (max 7)
- + 1 Werkzeug (max 7)
- + 1 tool (max 7)

ML16

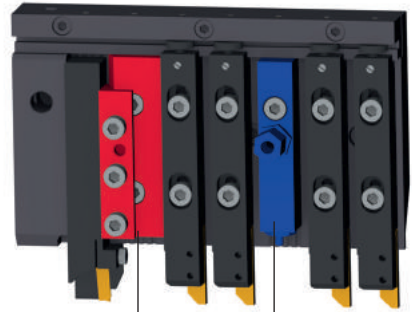
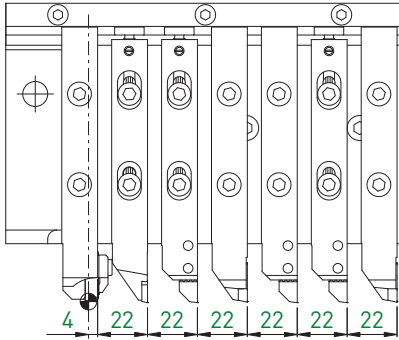

Outil \square 16 mm possible avec module de serrage
 Werkzeug \square 16 mm mit Spannelement möglich
 Tool \square 16 mm possible with clamping unit

Module d'arrosage (prend la place d'un outil)
 Kühlmittelzufuhrelement (nimmt den Platz eines Werkzeuges)
 Coolant supply unit (takes the place of one tool)



Accessoires
 Zubehöre
 Accessories

Art. N°	Porte-outils Halter Holders	Pages Seiten Pages	Module de serrage Spannelement Clamping unit	Module d'arrosage Kühlmittelzufuhrelement Coolant supply unit	Page Seite Page
ML16-STAR-SB20C/E	ML16	> 12.63	ML16-FIX-16/22	ML16-JET-7/16	12.82

- SR-16R** + 3 outils (max 9)
- Star SR-20R** + 3 Werkzeuge (max 9)
- SR-20RII** + 3 tools (max 9)

ML16

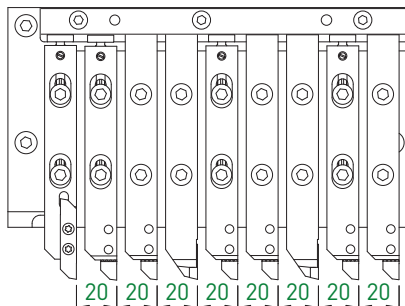

Outil 16 mm possible avec module de serrage
 Werkzeug 16 mm mit Spannelement möglich
 Tool 16 mm possible with clamping unit

Module d'arrosage (prend la place d'un outil)
 Kühlmittelzufuhrelement (nimmt den Platz eines Werkzeuges)
 Coolant supply unit (takes the place of one tool)



Accessoires
 Zubehöre
 Accessories

Art. N°	Porte-outils Holder Holders	Pages Seiten Pages	Module de serrage Spannelement Clamping unit	Module d'arrosage Kühlmittelzufuhrelement Coolant supply unit	Page Seite Page
ML16-STAR-SR-20R	ML16	> 12.63	ML16-FIX-16/20	ML16-JET-7/16	12.82

MODU-LINE

Star **SR-20RIII**
SR-20J

+ 3 outils (max 9)
+ 3 Werkzeuge (max 9)
+ 3 tools (max 9)

ML16

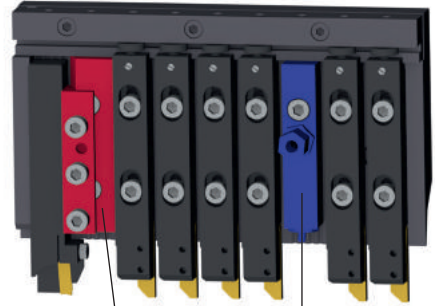
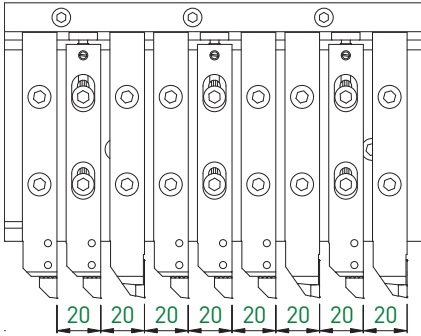

Outil \square 16 mm possible avec module de serrage
Werkzeug \square 16 mm mit Spannelement möglich
Tool \square 16 mm possible with clamping unit

Module d'arrosage (prend la place d'un outil)
Kühlmittelzufuhrelement (nimmt den Platz eines Werkzeuges)
Coolant supply unit (takes the place of one tool)



Art. N°	Porte-outils Halter Holders	Pages Seiten Pages	Accessoires Zubehöre Accessories		
			Module de serrage Spannelement Clamping unit	Module d'arrosage Kühlmittelzufuhrelement Coolant supply unit	Page Seite Page
ML16-STAR-SR-20RIII	ML16	> 12.63	ML16-FIX-16/20	ML16-JET-7/16	12.82
ML16-STAR-SR-20J					

Star SR20JII type A/B

- + 3 outils (max 9)
- + 3 Werkzeuge (max 9)
- + 3 tools (max 9)

ML16

new

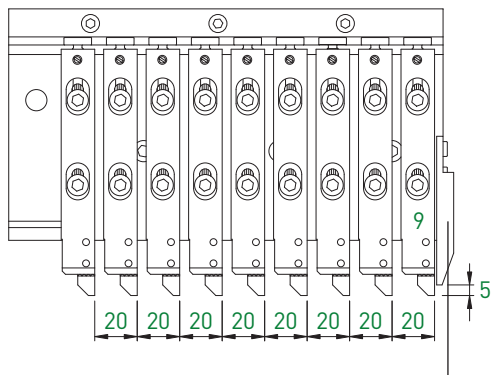

Risque de collision avec outil 9
 Kollisionsrisiko mit Werkzeug 9
 Collision risk with tool 9



Accessoires
 Zubehöre
 Accessories

Art. N°	Porte-outils Halter Holders	Pages Seiten Pages	Module de serrage Spannelement Clamping unit	Module d'arrosage Kühlmittelfzufuhrelement Coolant supply unit	Page Seite Page
ML16-STAR-SR20JII-A/B	ML16	> 12.63	ML16-FIX-16/20	ML16-JET-7/16	12.82

Star SR-20RIV

- + 1 outil (max 8)
- + 1 Werkzeug (max 8)
- + 1 tool (max 8)

ML16

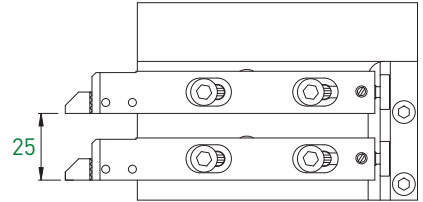
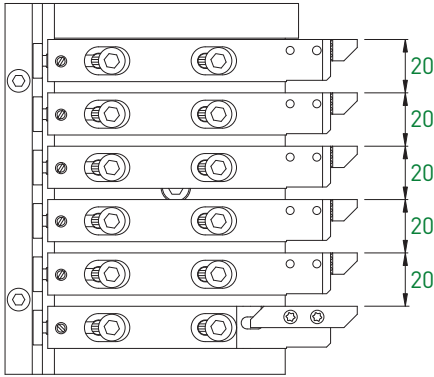

ML16-STAR-SR-20RIV-6T

ML16-STAR-SR-20RIV-2T

Type Typ Type	Art. N°	Porte-outils Halter Holders	Pages Seiten Pages	Module de serrage Spannelement Clamping unit	Accessoires Zubehöre Accessories	Page Seite Page
2T	ML16-STAR-SR-20RIV-2T	ML16	> 12.63	-	Module d'arrosage Kühlmittelezufuhrelement Coolant supply unit	ML16-JET-7/16
6T	ML16-STAR-SR-20RIV-6T					

Star SR-32J \varnothing max 32 mm + 1 outil (max 7)
 + 1 Werkzeug (max 7)
 + 1 tool (max 7)

\varnothing max 16 mm + 7 outils (max 13)
 + 7 Werkzeuge (max 13) **ML16**
 + 7 tools (max 13)

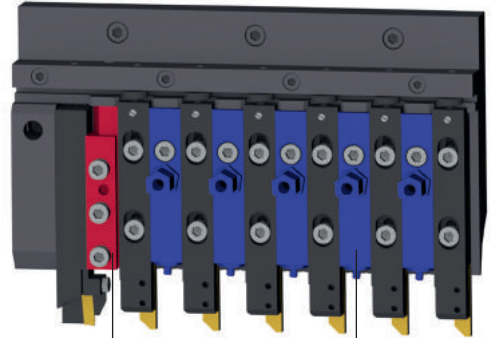
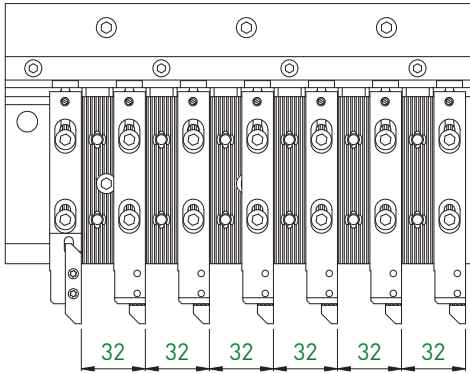

Outil \varnothing 16 mm possible avec module de serrage
 Werkzeug \varnothing 16 mm mit Spannelement möglich
 Tool \varnothing 16 mm possible with clamping unit

Module d'arrosage (prend la place d'un outil)
 Kühlmittelzufuhrelement (nimmt den Platz eines Werkzeuges)
 Coolant supply unit (takes the place of one tool)

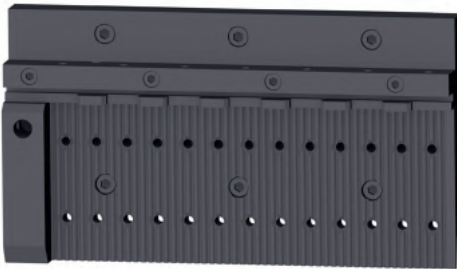

			Accessoires Zubehöre Accessories		
Art. N°	Porte-outils Halter Holders	Pages Seiten Pages	Module de serrage Spannelement Clamping unit	Module d'arrosage Kühlmittelzufuhrelement Coolant supply unit	Page Seite Page
ML16-STAR-SR-32J	ML16	> 12.63	ML16-FIX-16/16	ML16-JET-7/16	12.82

Star SV-12 / 20

+ 2 outils (max 7)
 + 2 Werkzeuge (max 7)
 + 2 tools (max 7)

ML16

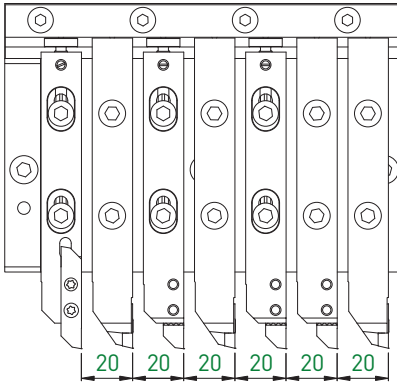

Outil ∇ 16 mm possible avec module de serrage
 Werkzeug ∇ 16 mm mit Spannelement möglich
 Tool ∇ 16 mm possible with clamping unit

Module d'arrosage (prend la place d'un outil)
 Kühlmittelzufuhrelement (nimmt den Platz eines Werkzeugs)
 Coolant supply unit (takes the place of one tool)

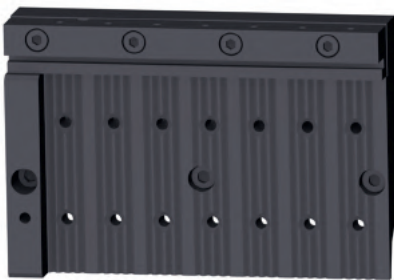

Accessoires
 Zubehör
 Accessories

Art. N°	Porte-outils Halter Holders	Pages Seiten Pages	Module de serrage Spannelement Clamping unit	Module d'arrosage Kühlmittelzufuhrelement Coolant supply unit	Page Seite Page
ML16-STAR-SV-12/20	ML16	> 12.63	ML16-FIX-16/20	ML16-JET-7/16	12.82

Star SV-20R

- + 2 outils (max 9)
- + 2 Werkzeuge (max 9)
- + 2 tools (max 9)

ML16

new

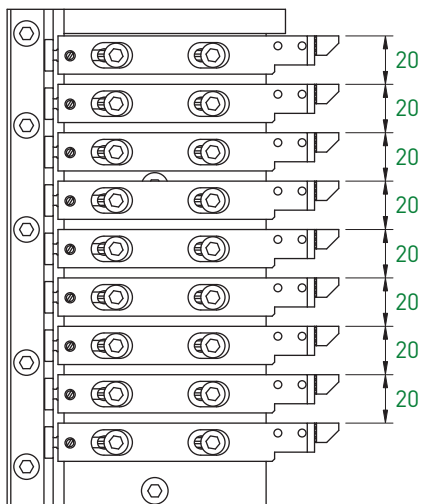

Accessoires
Zubehöre
Accessories

Art. N°	Porte-outils Halter Holders	Pages Seiten Pages	Module de serrage Spannelement Clamping unit	Module d'arrosage Kühlmittelzufuhrelement Coolant supply unit	Page Seite Page
ML16-STAR-SV-20R	ML16	> 12.63	ML16-FIX-16/20	ML16-JET-7/16	12.82

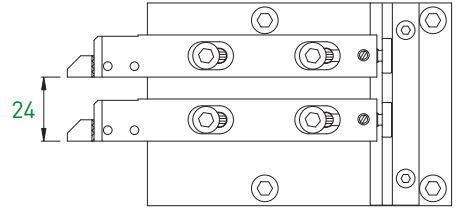
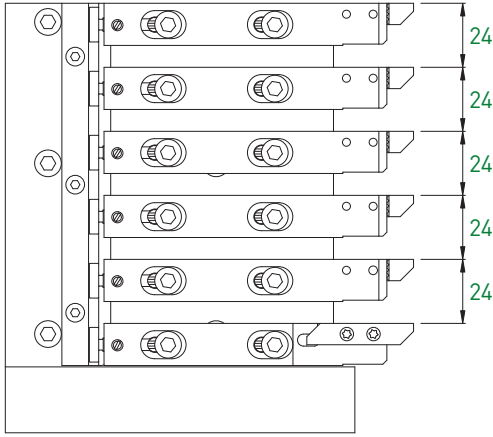

ML16-STAR-SW-20R-6T

ML16-STAR-SW-20R-2T

Accessoires
 Zubehör
 Accessories

Type Typ Type	Art. N°	Porte-outils Halter Holders	Pages Seiten Pages	Module de serrage Spannelement Clamping unit	Module d'arrosage Kühlmittelezufuhrelement Coolant supply unit	Page Seite Page
2T	ML16-STAR-SW-20R-2T	ML16	> 62	-	ML16-JET-7/16	12.82
6T	ML16-STAR-SW-20R-6T			ML16-FIX-16/24		

Jet

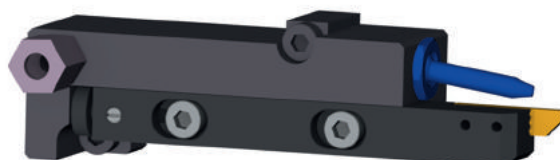

Duo

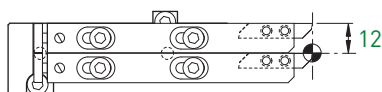
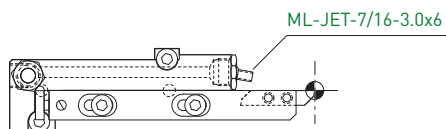
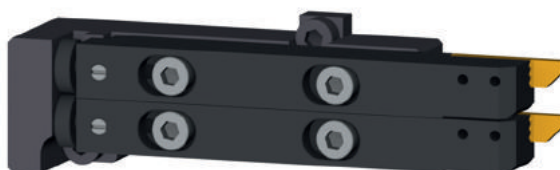

Jet



Duo

Type Typ Type	Art. N°	Porte-outils Halter Holders	Pages Seiten Pages	Module de serrage Spannelement Clamping unit	Accessoires Zubehöre Accessories	Page Seite Page
Jet	ML12-DEC010-JET	ML12	> 12.63	-	Module d'arrosage Kühlmittelezufuhrelement Coolant supply unit	12.82
Duo	ML12-DEC010-DUO				ML-JET-7/16... ML12-JET-5/16	

Tornos **SwissNano**
SwissNano 7

+ 2 outils (max 6)
+ 2 Werkzeuge (max 6)
+ 2 tools (max 6)

ML12

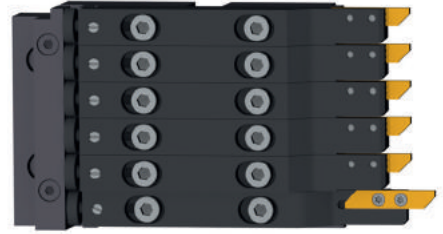
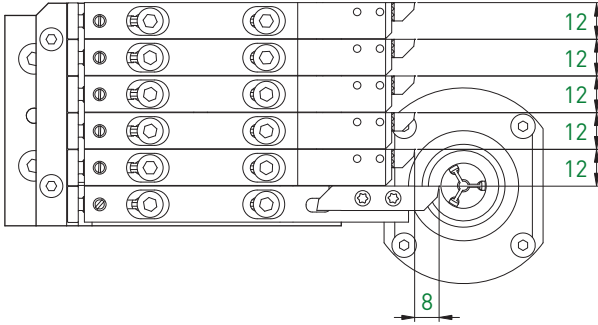

6T



6T

Accessoires
Zubehöre
Accessories

Type Typ Type	Art. N°	Porte-outils Halter Holders	Pages Seiten Pages	Module de serrage Spannelement Clamping unit	Module d'arrosage Kühlmittelezufuhrelement Coolant supply unit	Page Seite Page
6T	ML12-SWISS-NANO-6T	ML12	> 12.63	-	ML12-JET-5/16	12.82

Tornos **SwissNano**
SwissNano 7

ML12

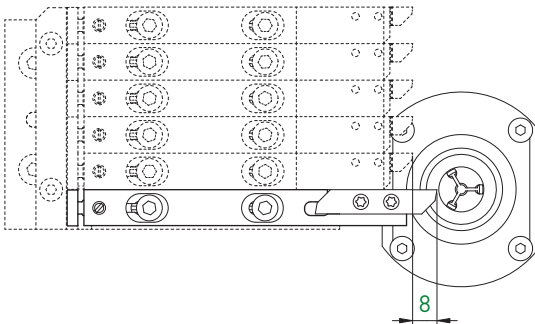

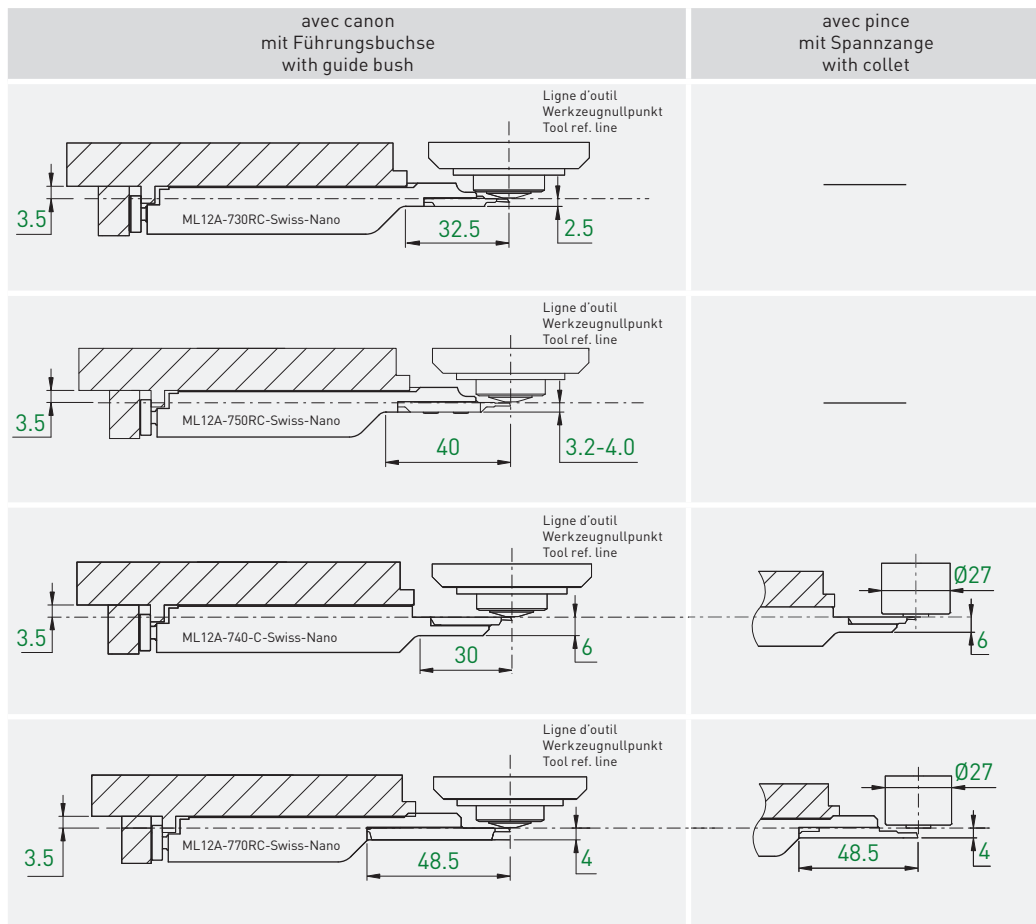

Type de machine Maschinen-Typ Type of machine	Porte-outils Halter Holders	Art. N°	Plaquettes Wendepplatten Inserts	Pages Seiten Pages
SwissNano	ML12	ML12A-730RC-SWISS-NANO	731R... / 731RSF	> TOP-Line TOP-Watch
		ML12A-750RC-SWISS-NANO	751R... / 751RDSF	
		ML12A-740-C-SWISS-NANO	741... / 741SF	
		ML12A-770RC-SWISS-NANO	771R...	

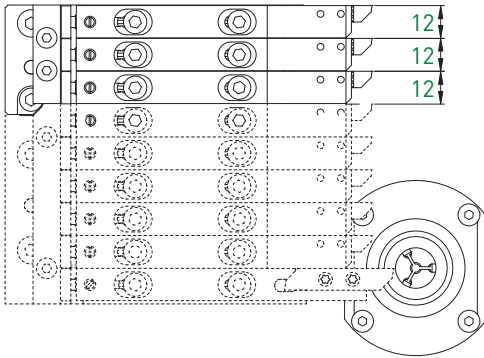
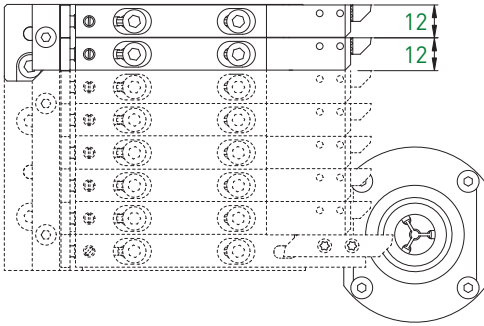

2T



3T

Accessoires
Zubehöre
Accessories

Type Typ Type	Art. N°	Porte-outils Halter Holders	Pages Seiten Pages	Module de serrage Spannelement Clamping unit	Module d'arrosage Kühlmittelzufuhrelement Coolant supply unit	Page Seite Page
2T	ML12-SWISS-NANO-2T	ML12	> 12.63	-	ML12-JET-5/16	12.82
3T	ML12-SWISS-NANO-3T					

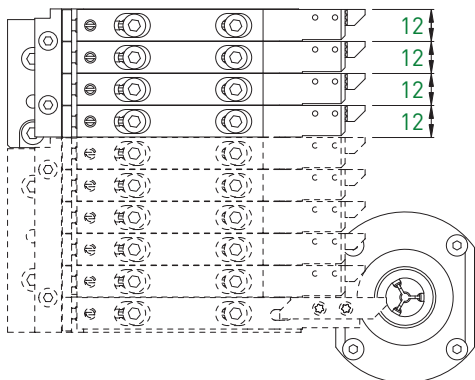

Type Typ Type	Art. N°	Porte-outils Halter Holders	Pages Seiten Pages	Accessoires Zubehöre Accessories		
				Module de serrage Spannelement Clamping unit	Module d'arrosage Kühlmittelelement Coolant supply unit	Page Seite Page
4T	ML12-SWISS-NANO-7-4T	ML12	> 12.63	-	ML12-JET-5/16	12.82

Tornos DT 13

+ 3 outils (max 9)
 + 3 Werkzeuge (max 9)
 + 3 tools (max 9)

ML12

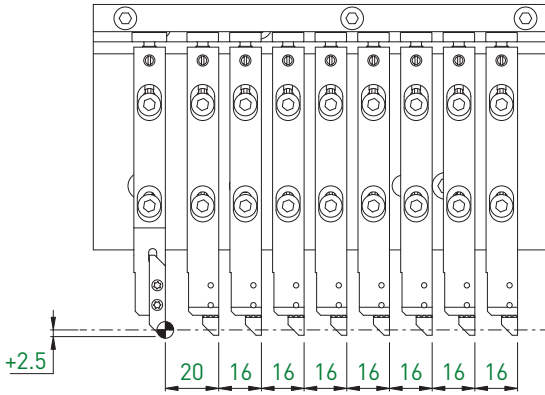

Accessoires
 Zubehör
 Accessories

Type Typ Type	Art. N°	Porte-outils Halter Holders	Pages Seiten Pages	Module de serrage Spannelement Clamping unit	Module d'arrosage Kühlmitelzufuhrelement Coolant supply unit	Page Seite Page
9T	ML12-DT13-2020206-9T	ML12	> 12.63	-	ML12-JET-5/16	12.82

Tornos CT 20

- + 1 outil (max 7)
- + 1 Werkzeug (max 7)
- + 1 tool (max 7)

ML12

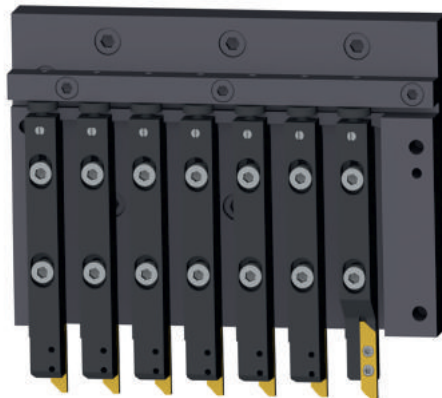
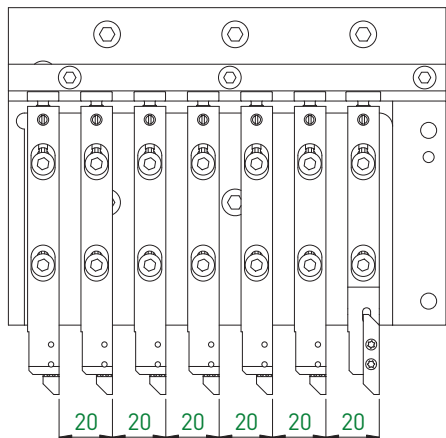

Accessoires
Zubehöre
Accessories

Type Typ Type	Art. N°	Porte-outils Halter Holders	Pages Seiten Pages	Module de serrage Spannelement Clamping unit	Module d'arrosage Kühlmitelzufuhrelement Coolant supply unit	Page Seite Page
7T	ML12-CT20-2020019-7T	ML12	> 12.63	-	ML12-JET-5/16	12.82

Tornos GT 13

- + 5 outils (max 12)
- + 5 Werkzeuge (max 12)
- + 5 tools (max 12)

ML12

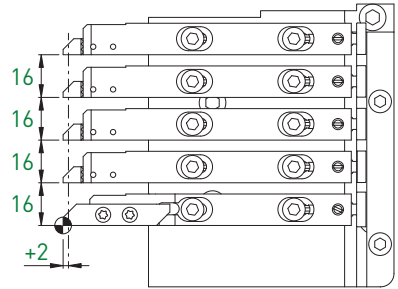
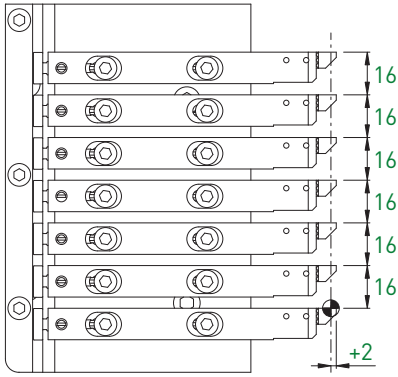



ML12-GT13-390223-7T



ML12-GT13-390224-5T

Type Typ Type	Art. N°	Porte-outils Halter Holders	Pages Seiten Pages	Accessoires Zubehöre Accessories		
				Module de serrage Spannelement Clamping unit	Module d'arrosage Kühlmittelzufuhrelement Coolant supply unit	Page Seite Page
5T	ML12-GT13-390224-5T	ML12	> 12.63	-	ML12-JET-5/16	12.82
7T	ML12-GT13-390223-7T					

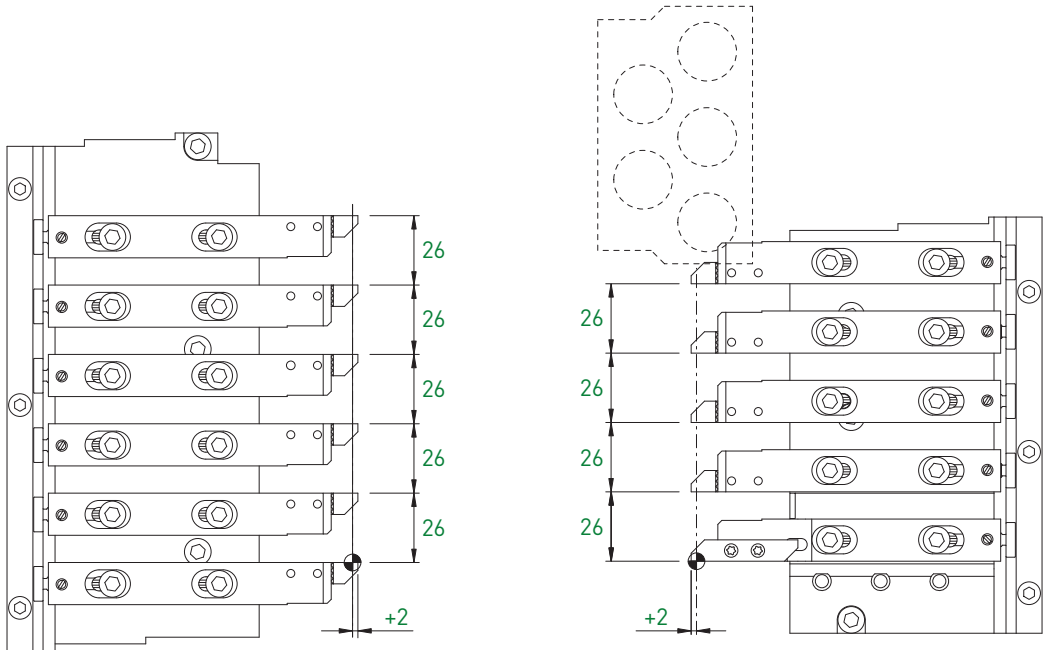

1 serrage ML16-FIX-16 pour outil \square 16 mm inclus
 1 Spannung ML16-FIX-16 für Werkzeug \square 16 mm inbegriffen
 1 clamping ML16-FIX-16 for tool \square 16 mm included



ML16-GT26-386209-6T



ML16-GT26-386210-5T

Type Typ Type	Art. N°	Porte-outils Halter Holders	Pages Seiten Pages	Accessoires Zubehöre Accessories		
Type	Art. N°	Porte-outils Halter Holders	Pages Seiten Pages	Module de serrage Spannelement Clamping unit	Module d'arrosage Kühlmittelezufuhrelement Coolant supply unit	Page Seite Page
5T	ML16-GT26-386210-5T	ML16	> 12.63	-	ML16-JET-7/16	12.82
6T	ML16-GT26-386209-6T					

Tornos GT 32

+ 9 outils
 max + 9 Werkzeuge
 + 9 tools

ML16

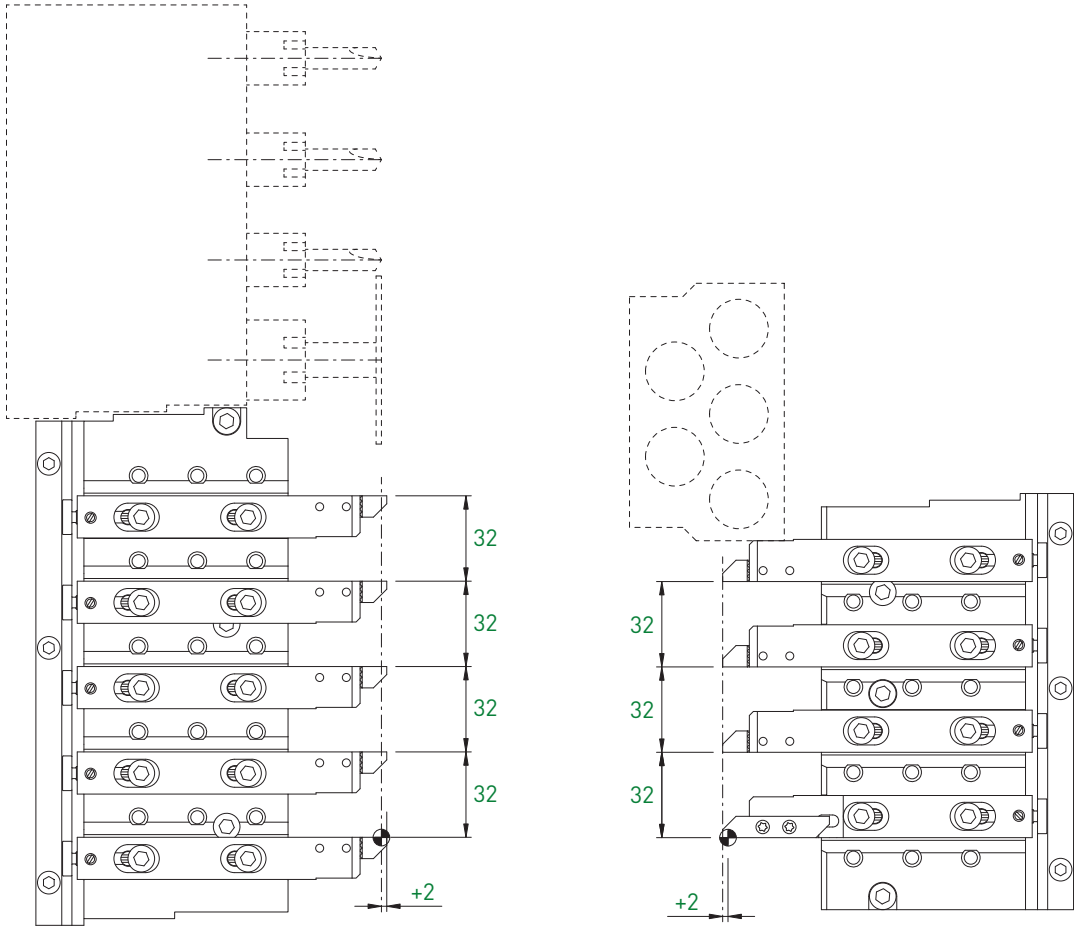

Holder ML16

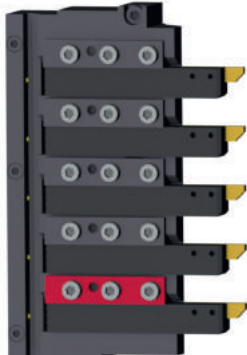

Holder □16



Holder ML16



Holder □16



ML16-GT32-386209-5T



ML16-GT32-386210-4T

				Accessoires Zubehöre Accessories			
Type Typ Type	Art. N°	Porte-outils Halter Holders	Pages Seiten Pages	Module de serrage Spannelement Clamping unit		Module d'arrosage Kühlmittelzufuhrelement Coolant supply unit	Pages Seiten Pages
4T	ML16-GT32-386210-4T	ML16	> 12.63	1x inclus 1x inbegriffen 1x included	Option ML16-FIX-16	ML16-JET-7/16	12.82
5T	ML16-GT32-386209-5T						

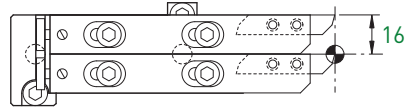
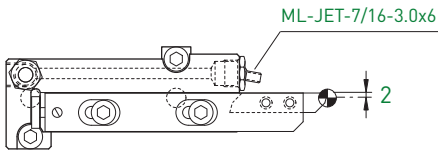

Jet



Duo

Accessoires
Zubehöre
Accessories

Type Typ Type	Art. N°	Porte-outils Halter Holders	Pages Seiten Pages	Module de serrage Spannelement Clamping unit	Module d'arrosage Kühlmittelezufuhrelement Coolant supply unit	Page Seite Page
Jet	ML16-DEC013-JET	ML16	> 12.63	-	ML-JET-7/16...	12.82
Duo	ML16-DEC013-DUO				ML16-JET-7/16	12.82

Jet



Duo

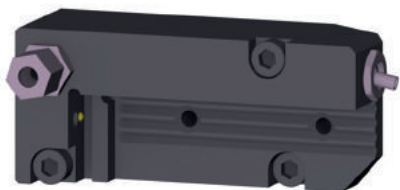
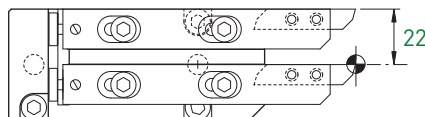
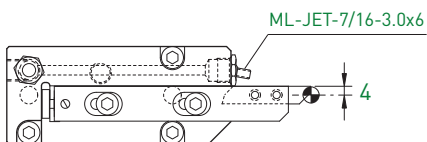

Jet



Duo

Accessoires
Zubehöre
Accessories

Type Typ Type	Art. N°	Porte-outils Halter Holders	Pages Seiten Pages	Module de serrage Spannelement Clamping unit	Module d'arrosage Kühlmittelezufuhrelement Coolant supply unit	Page Seite Page
Jet	ML16-DECO20-JET	ML16	> 12.63	-	ML-JET-7/16...	12.82
Duo	ML16-DECO20-DUO				ML16-JET-7/16	12.82

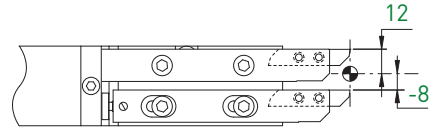
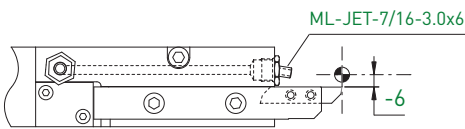
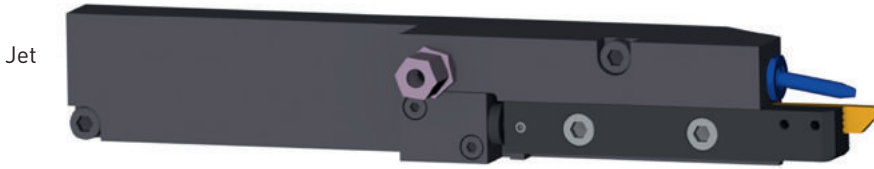

Jet



Duo

Accessoires
Zubehöre
Accessories

Type Typ Type	Art. N°	Porte-outils Halter Holders	Pages Seiten Pages	Module de serrage Spannelement Clamping unit	Module d'arrosage Kühlmittelezufuhrelement Coolant supply unit	Page Seite Page
Jet	ML16-S20-JET	ML16	> 12.63	-	ML-JET-7/16...	12.82
Duo	ML16-S20-DUO				ML16-JET-7/16	12.82

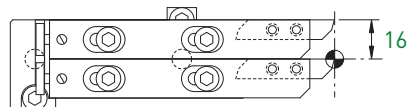
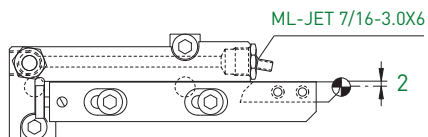
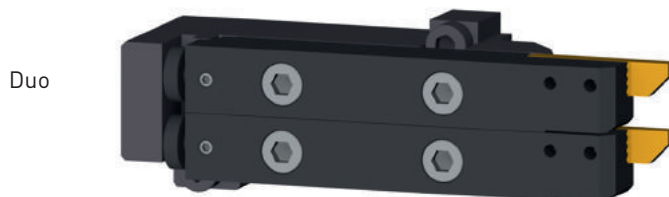

Jet



Duo

Type Typ Type	Art. N°	Porte-outils Halter Holders	Pages Seiten Pages	Module de serrage Spannelement Clamping unit	Accessoires Zubehöre Accessories	Module d'arrosage Kühlmittelezufuhrelement Coolant supply unit	Page Seite Page
Jet	ML16-SWISS-ST26-JET	ML16	> 12.63	-		ML-JET-7/16...	12.82
Duo	ML16-SWISS-ST26-DUO					ML16-JET-7/16	12.82

Tornos DT 26

- + 1 outil (max 7)
- + 1 Werkzeug (max 7)
- + 1 tool (max 7)

ML16

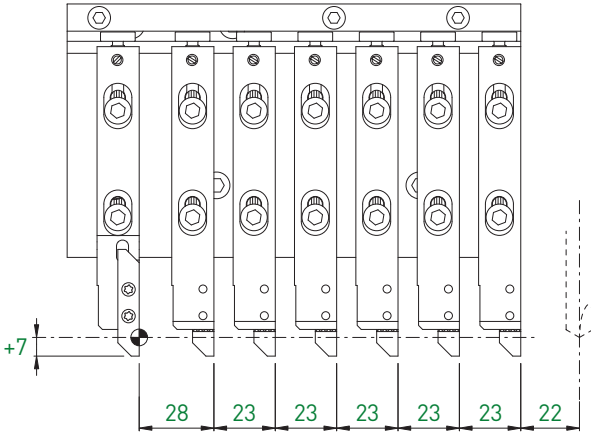

Accessoires
Zubehöre
Accessories

Type Typ Type	Art. N°	Porte-outils Halter Holders	Pages Seiten Pages	Module de serrage Spannelement Clamping unit	Module d'arrosage Kühlmittelzufuhrelement Coolant supply unit	Page Seite Page
7T	ML16-DT26-2020206-7T	ML16	> 12.63	-	ML16-JET-7/16	12.82

Tsugami B074

- + 3 outils (max 6)
- + 3 Werkzeuge (max 6)
- + 3 tools (max 6)

ML12

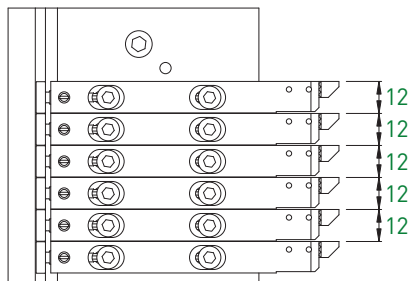

Type Typ Type	Art. N°	Porte-outils Halter Holders	Pages Seiten Pages	Accessoires Zubehöre Accessories		
				Module de serrage Spannelement Clamping unit	Module d'arrosage Kühlmittelzufuhrelement Coolant supply unit	Page Seite Page
6T	ML12-B074-1-6T	ML12	> 12.63	-	ML12-JET-5/16	12.82

Tsugami B075

- + 5 outils (max 8)
- + 5 Werkzeuge (max 8)
- + 5 tools (max 8)

ML12

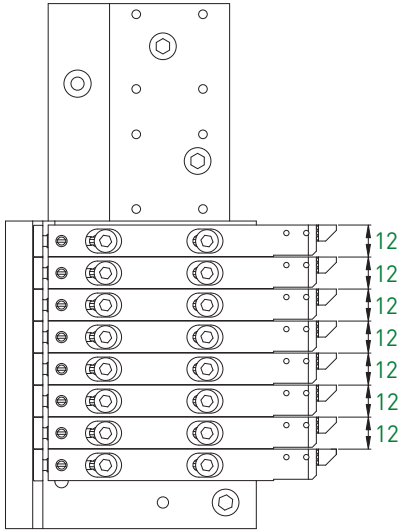

Type Typ Type	Art. N°	Porte-outils Halter Holders	Pages Seiten Pages	Accessoires Zubehöre Accessories		
				Module de serrage Spannelement Clamping unit	Module d'arrosage Kühlmitelzufuhrelement Coolant supply unit	Page Seite Page
8T	ML12-B075-1-8T	ML12	> 12.63	-	ML12-JET-5/16	12.82

Tsugami P034

+ 3 outils (max 9)
 + 3 Werkzeuge (max 9)
 + 3 tools (max 9)

ML12

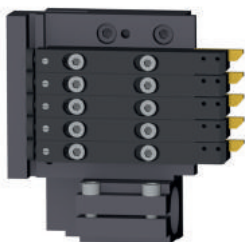
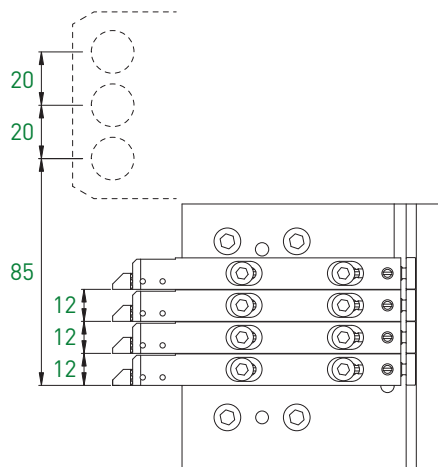
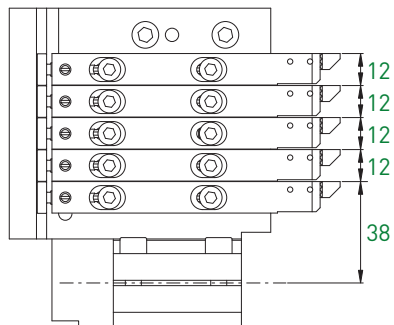

ML12-P034-1-5T

ML12-P034-2-4T

Type Typ Type	Art. N°	Porte-outils Halter Holders	Pages Seiten Pages	Module de serrage Spannelement Clamping unit	Module d'arrosage Kühlmittelzufuhrelement Coolant supply unit	Page Seite Page
4T	ML12-P034-2-4T	ML12	> 12.63	-	ML12-JET-5/16	12.82
5T	ML12-P034-1-5T					

Accessoires
 Zubehöre
 Accessories

Tsugami P034

max + 17 outils
+ 17 Werkzeuge
+ 17 tools

ML12

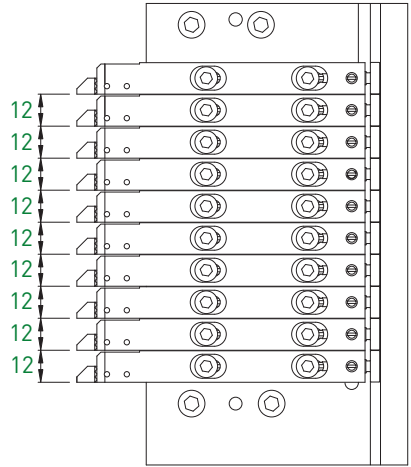
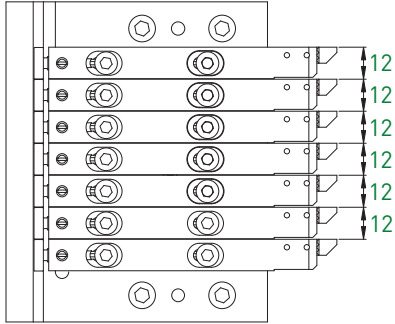

ML12-P034-1-7T

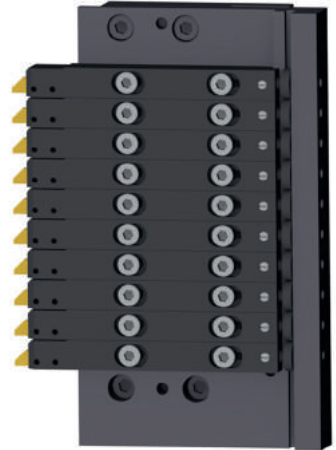

ML12-P034-2-10T



ML12-P034-1-7T



ML12-P034-2-10T

Type Typ Type	Art. N°	Porte-outils Halter Holders	Pages Seiten Pages	Accessoires Zubehöre Accessories		
				Module de serrage Spannelement Clamping unit	Module d'arrosage Kühlmitelzufuhrelement Coolant supply unit	Page Seite Page
7T	ML12-P034-1-7T	ML12	> 12.63	-	ML12-JET-5/16	12.82
10T	ML12-P034-2-10T					

Les différents types de porte-outils
Die verschiedenen Haltertypen
The various types of holders

Type Standard

ML12A-740

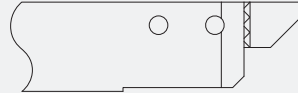

Type -D

ML12A-740-D



Type -JET-D

ML12A-740-JET-D

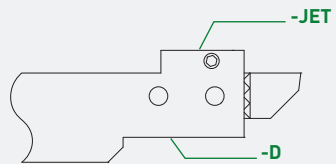
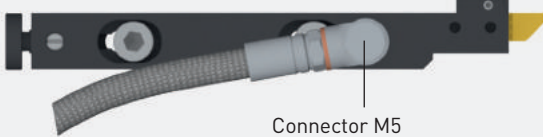

Type -JET

ML12A-740-JET

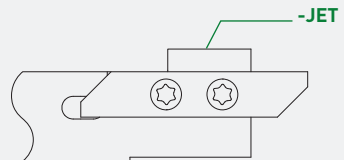
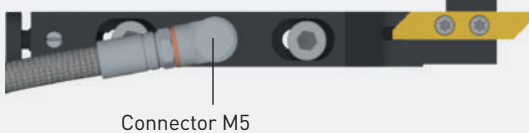

Informations techniques
 Technische Informationen
 Technical information

Porte-outils
 Halter
 Holders

Compatibilité
 Kompatibilität
 Compatibility

OK

NOT OK

-JET-D -D

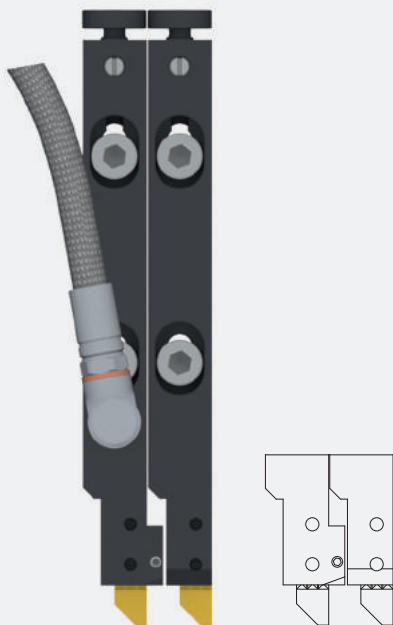

-JET-D -Standard

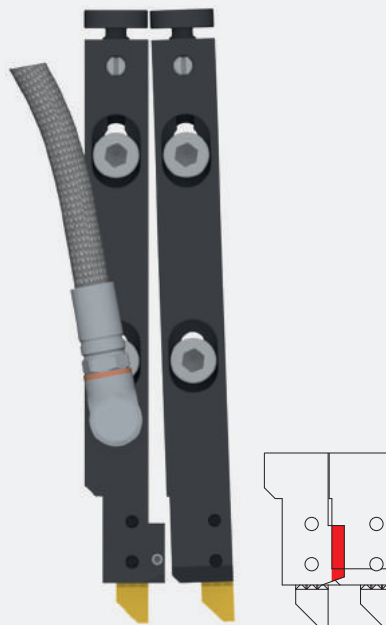

MIX

TYPE D

-Standard -JET-D -D



-JET-D -D -JET-D -D

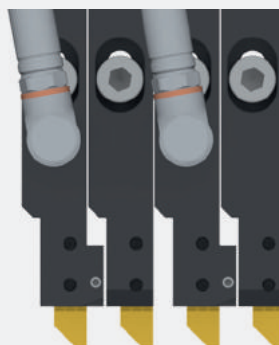

Exceptions
 Ausnahmen
 Exceptions

Exception ML12

Exception ML16

-JET-D
 -JET -Standard



15

≥ 15 mm = Total compatibility

-JET-D
 -JET -Standard

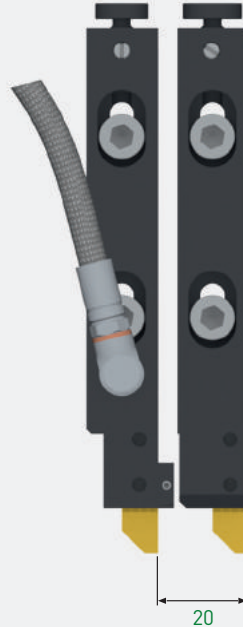

20

≥ 20 mm = Total compatibility

Brochure JET-Line:

Système de distribution du liquide de refroidissement pour haute pression

JET-Line Broschüre:

Kühlmittelverteilungssystem für hohen Druck

JET-Line brochure:

Coolant distribution system for high pressure

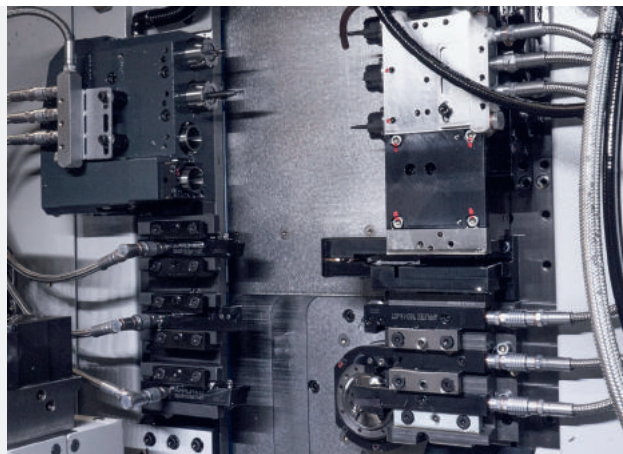

Porte-outils

Halter

Holders

ML12 / ML16

Système de fixation
Befestigungssystem
Clamping system

A = réglable
einstellbar
adjustable

F = longueur fixe
fixlänge
fixed length

ML12A

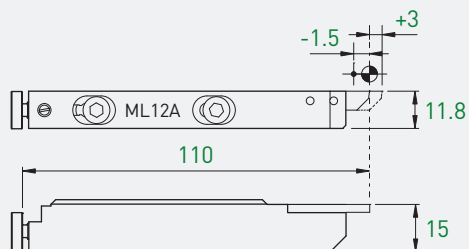

ML12F

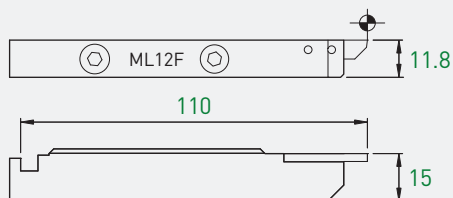

ML16A

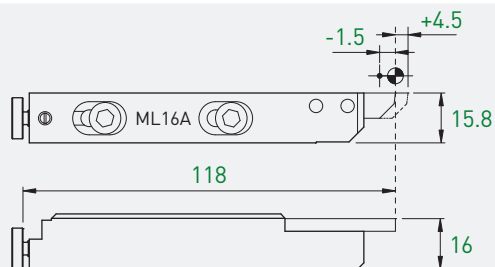

ML16F

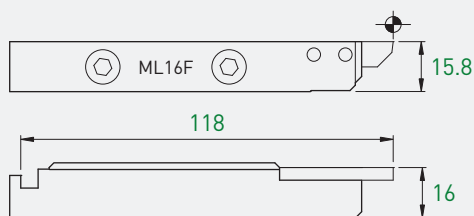

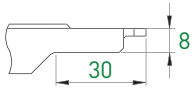

TOP-Line
731-737

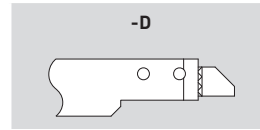

Art. N°	Art. N°	Art. N°
ML12	ML12	ML12
-	ML12A-730-C-D new	-

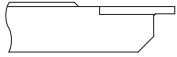

TOP-Line
741-747

Standard	-D	-JET-D
ML12	ML12	ML12
ML12A-740	ML12A-740-D	ML12A-740-JET-D
ML12F-740	ML12F-740-D	-
ML16	ML16	ML16
ML16A-740	ML16A-740-D	ML16A-740-JET-D
ML16F-740	-	-

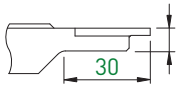

TOP-Line
741-747

ML12	ML12	ML12
ML12A-740-C	ML12A-740-C-D	ML12A-740-C-JET-D
ML12F-740-C	ML12F-740-C-D	-

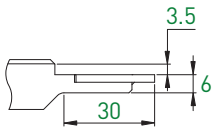

TOP-Line
741

ML12	ML12	ML12
ML12A-740-C-R04	-	-
ML12A-740-C-SWISS-NANO	-	-

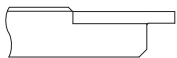

TOP-Line
761-767

ML12	ML12	ML12
ML12A-760	ML12A-760-D	ML12A-760-JET-D
ML12F-760	ML12F-760-D	-
ML16	ML16	ML16
ML16A-760	ML16A-760-D	ML16A-760-JET-D
ML16F-760	-	-

Porte-plaquettes



WSP-Halter

Insert holders

TOP-Line

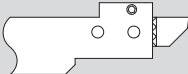

TOP-Line
761-767

Standard	-D	-JET-D
		
Art. N°	Art. N°	Art. N°
ML16	ML16	ML16
ML16A-760-C	ML16A-760-C-D	-
ML16F-760-C	-	-

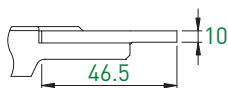

TOP-Line
781

ML16	ML16	ML16
-	ML16A-780-C-D	-

Porte-plaquettes



WSP-Halter

Insert holders

TURN-Line

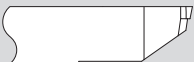

TURN-Line
347-349

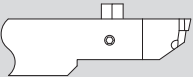
Standard	-D	-JET-D
		
Art. N°	Art. N°	Art. N°
ML12	ML12	ML12
ML12A-340	ML12A-340-D	ML12A-340-JET-D
ML12F-340	ML12F-340-D	-
ML16	ML16	ML16
ML16A-340	ML16A-340-D	ML16A-340-JET-D
ML16F-340	-	-

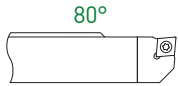

ISO-Line
CC...-0602..

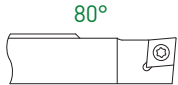

ISO-Line
CC...-09T3..

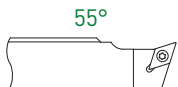

ISO-Line
DC...-0702..

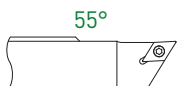

ISO-Line
DC...-0702..

Standard	-D	-JET-D
Art. N°	Art. N°	Art. N°
ML12	ML12	ML12
ML12A-SCLCR06	ML12A-SCLCR06-D	ML12A-SCLCR06-JET-D
ML12F-SCLCR06	ML12F-SCLCR06-D	-
ML16	ML16	ML16
ML16A-SCLCR06	ML16A-SCLCR06-D	ML16A-SCLCR06-JET-D
ML16F-SCLCR06	ML16F-SCLCR06-D	-

ML12	ML12	ML12
ML12A-SCLCR09	ML12A-SCLCR09-D	ML12A-SCLCR09-JET-D
ML12F-SCLCR09	ML12F-SCLCR09-D	-
ML16	ML16	ML16
ML16A-SCLCR09	ML16A-SCLCR09-D	ML16A-SCLCR09-JET-D
ML16F-SCLCR09	ML16F-SCLCR09-D	-

ML16	ML16	ML16
ML16A-SDHCR07	-	-

ML12	ML12	ML12
ML12A-SDJCR07	ML12A-SDJCR07-D	ML12A-SDJCR07-JET-D
ML12F-SDJCR07	ML12F-SDJCR07-D	-
ML16	ML16	ML16
ML16A-SDJCR07	ML16A-SDJCR07-D	ML16A-SDJCR07-JET-D
ML16F-SDJCR07	ML16F-SDJCR07-D	-

Porte-plaquettes

WSP-Halter

Insert holders

ISO-Line

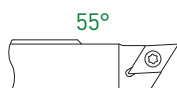

ISO-Line
DC...-11T3..

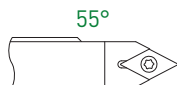

ISO-Line
DC...-11T3..



ISO-Line
VC...-1103..

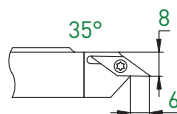

ISO-Line
VC...-1103..

Standard	-D	-JET-D
Art. N°	Art. N°	Art. N°
ML12	ML12	ML12
ML12A-SDJCR11	ML12A-SDJCR11-D	ML12A-SDJCR11-JET-D
ML12F-SDJCR11	ML12F-SDJCR11-D	-
ML16	ML16	ML16
ML16A-SDJCR11	ML16A-SDJCR11-D	ML16A-SDJCR11-JET-D
ML16F-SDJCR11	ML16F-SDJCR11-D	-

ML12	ML12	ML12
ML12A-SDNCN11	ML12A-SDNCN11-D	-
ML12F-SDNCN11	ML12F-SDNCN11-D	-
ML16	ML16	ML16
ML16A-SDNCN11	ML16A-SDNCN11-D	-
ML16F-SDNCN11	ML16F-SDNCN11-D	-

ML12	ML12	ML12
ML12A-SVJCR11	ML12A-SVJCR11-D	ML12A-SVJCR11-JET-D
ML12F-SVJCR11	ML12F-SVJCR11-D	-
ML16	ML16	ML16
ML16A-SVJCR11	ML16A-SVJCR11-D	ML16A-SVJCR11-JET-D
ML16F-SVJCR11	ML16F-SVJCR11-D	-

ML12	ML12	ML12
ML12A-SV-CR11	ML12A-SV-CR11-D	-
ML16	ML16	ML16
ML16A-SV-CR11	ML16A-SV-CR11-D	-

MODU-LINE

Porte-plaquettes
WSP-Halter
Insert holders

ISO-Line

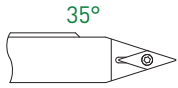

ISO-Line
VC...-1103..

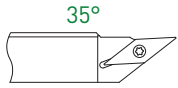

ISO-Line
VC...-1303..

Standard	-D	-JET-D
Art. N°	Art. N°	Art. N°
ML12	ML12	ML12
ML12A-SVVCN11	ML12A-SVVCN11-D	ML12A-SVVCN11-JET-D
ML12F-SVVCN11	ML12F-SVVCN11-D	-
ML16	ML16	ML16
ML16A-SVVCN11	ML16A-SVVCN11-D	-
ML16F-SVVCN11	ML16F-SVVCN11-D	-
ML12	ML12	ML12
-	ML12A-SVJCR13-D	-
ML16	ML16	ML16
-	ML16A-SVJCR13-D	ML16A-SVJCR13-JET-D

Porte-plaquettes
WSP-Halter
Insert holders

EVOCUT-Line

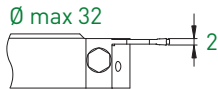

EVOCUT-Line
ET20..

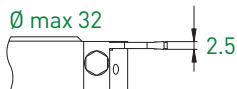

EVOCUT-Line
ET25..

		-JET (-D)
Art. N°	Art. N°	Art. N°
ML16	ML16	ML16
-	-	ML16A-ET20-JET32
ML16	ML16	ML16
-	-	ML16A-ET25-JET32

Porte-plaquettes

WSP-Halter

Insert holders

EVOCUT-Line

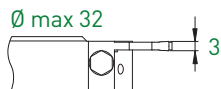

EVOCUT-Line
ET30..

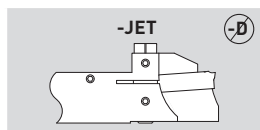

Art. N°	Art. N°	Art. N°
ML16	ML16	ML16
-	-	ML16A-ET30-JET32

Porte-plaquettes

WSP-Halter

Insert holders

CUT-Line

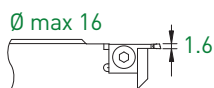

CUT-Line
CUT16..

Standard		
Art. N°	Art. N°	Art. N°
ML12	ML12	ML12
ML12A-CUT16	-	-
ML12F-CUT16	-	-
ML16	ML16	ML16
ML16A-CUT16	-	-
ML16F-CUT16	-	-



CUT-Line
CUT22..

ML12	ML12	ML12
ML12A-CUT22	-	-
ML12F-CUT22	-	-
ML16	ML16	ML16
ML16A-CUT22	-	-
ML16F-CUT22	-	-

MODU-LINE

Porte-plaquettes

WSP-Halter

Insert holders

PRO-Line

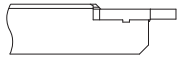

PRO-Line
642-647

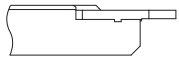

PRO-Line
661

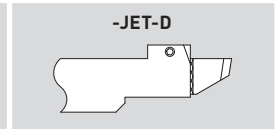
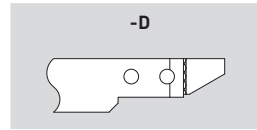

Art. N°	Art. N°	Art. N°
ML12	ML12	ML12
-	ML12A-640-D	ML12A-640-JET-D
ML16	ML16	ML16
-	ML16A-640-D	ML16A-640-JET-D

ML12	ML12	ML12
-	ML12A-660-D	ML12A-660-JET-D
ML16	ML16	ML16
-	ML16A-660-D	ML16A-660-JET-D

Porte-plaquettes



WSP-Halter

Insert holders

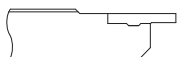
ECO-Line



ECO-Line
261-266

Standard	-D	-JET-D
		
Art. N°	Art. N°	Art. N°
ML12	ML12	ML12
ML12A-260	ML12A-260-D	ML12A-260-JET-D
ML12F-260	ML12F-260-D	-
ML16	ML16	ML16
ML16A-260	ML16A-260-D	ML16A-260-JET-D
ML16F-260	-	-

Porte-outils

Halter

Holder

IN-Line

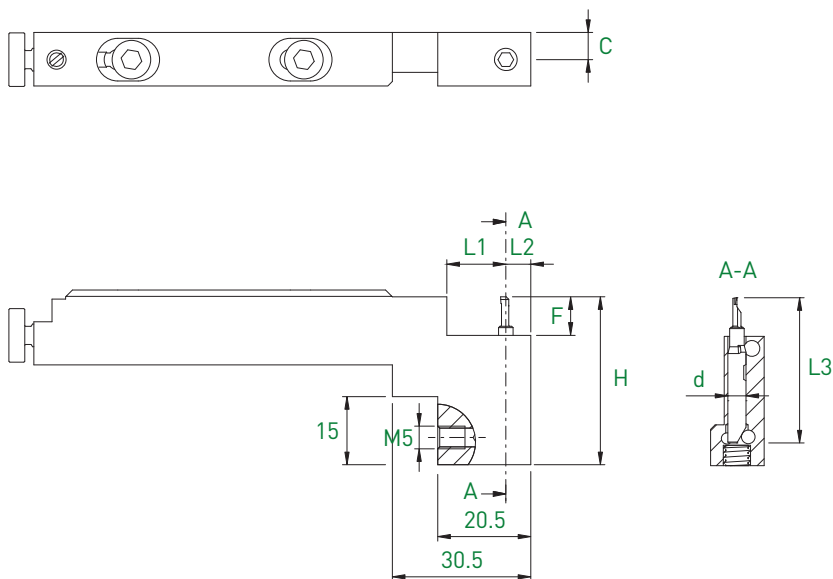

								ML12
d	Compatible bars	L3	F	H	C	L1	L2	Art. N°
4	BB4R... BF4R...	32	8.5	37	6	13	5.5	ML12A-BHK4N-32R-D
		37	13.5	42	6	13	5.5	ML12A-BHK4N-37R-D
		42	18.5	47	6	13	5.5	ML12A-BHK4N-42R-D

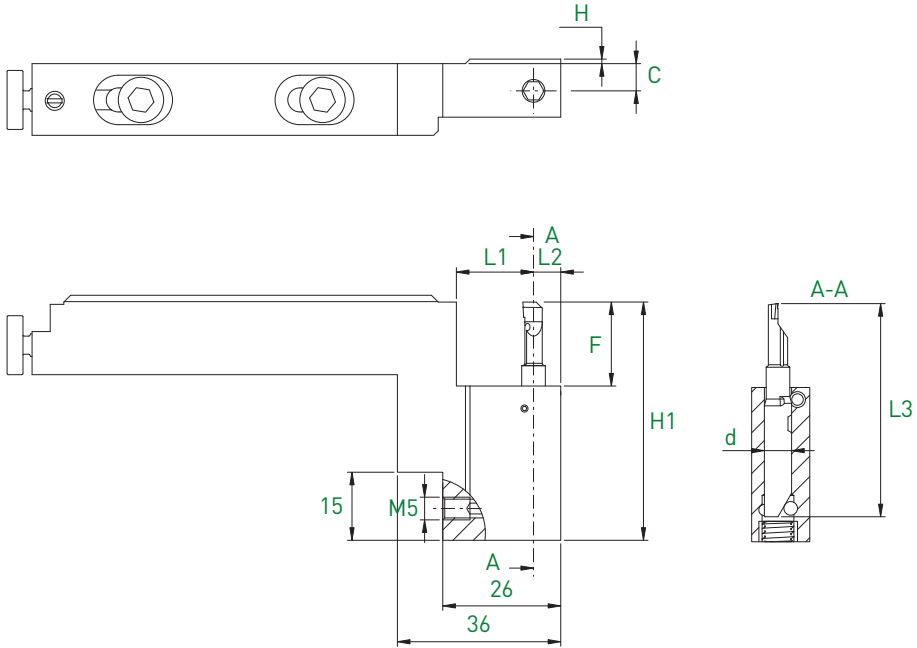

									ML16
d	Compatible bars	L3	F	H1	C	H	L1	L2	Art. N°
4	BB4R... BF4R...	32	8.5	37	6	-	17.5	5.5	ML16A-BHK4N-32R-D
		37	13.5	42	6	-	17.5	5.5	ML16A-BHK4N-37R-D
		42	18.5	47	6	-	17.5	5.5	ML16A-BHK4N-42R-D

									ML16
d	Compatible bars	L3	F	H1	C	H	L1	L2	Art. N°
6	BB4R... BF4R...	47	18.5	52.5	6	1	17	6	ML16A-BHK6N-47R-D
		57	28.5	62.5	6	1	17	6	ML16A-BHK6N-57R-D

Porte-outils

Halter

Holder

TOOLING-Line

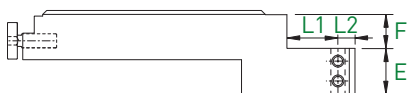
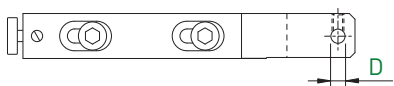

					ML12
F	D	E	L1	L2	Art. N°
8	3	12	13	6	ML12A-2440-8-3
8	4	12	13	6	ML12A-2440-8-4
8	5	12	13	6	ML12A-2440-8-5
12	6	12	13	6	ML12A-2440-12-6

					ML16
F	D	E	L1	L2	Art. N°
12	3	16	18	6	ML16A-2440-12-3
12	4	16	18	6	ML16A-2440-12-4
12	5	16	18	6	ML16A-2440-12-5
12	6	16	18	6	ML16A-2440-12-6
18	8	16	18	6	ML16A-2440-18-8

Porte-molettes

Rändelhalter

Knurl holders

TOOLING-Line

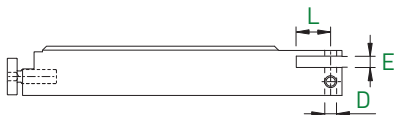
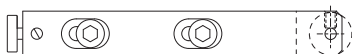

			ML12
E	D	L	Art. N°
4	4	8	ML12A-2402-44

			ML16
E	D	L	Art. N°
4	4	11	ML16A-2402-44

MODU-LINE

Porte-plaquettes – Coupe déportée & contre-opération

WSP-Halter – Versetztes Schneiden & Gegenspindel

Insert holders – Cut off line & cut on subspindle

Coupe à droite déportée ou usinage
à gauche sur contre-broche

Rechtsschneidend versetzt oder
linksschneidend auf Gegenspindel

Right hand cut off line or left hand
cut on subspindle

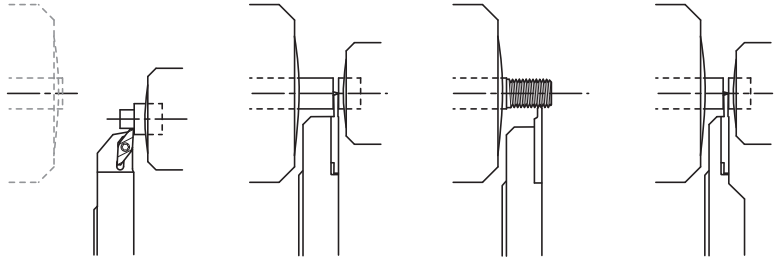

TURN-Line
ISO-Line

TOP-Line
EVOCUT-Line
CUT-Line
PRO-Line
ECO-Line

TOP-Line
EVOCUT-Line
CUT-Line
PRO-Line
ECO-Line

TOP-Line
PRO-Line
ECO-Line

Porte-plaquettes – Coupe déportée & contre-opération



WSP-Halter – Versetztes Schneiden & Gegenspindel

Insert holders – Cut off line & cut on subspindle

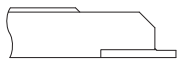
TOP-Line



TOP-Line
731-737

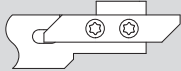

Standard	-D	-JET-D
		
Art. N°	Art. N°	Art. N°
ML12	ML12	ML12
ML12A-730-V	ML12A-730-V-D	ML12A-730-V-JET-D
ML16	ML16	ML16
ML16A-730-V	ML16A-730-V-D	ML16A-730-V-JET-D

Porte-plaquettes – Coupe déportée & contre-opération

WSP-Halter – Versetztes Schneiden & Gegenspindel

Insert holders – Cut off line & cut on subspindle

TOP-Line

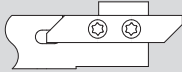
Standard	-D	-JET 
		
Art. N°	Art. N°	Art. N°
ML12	ML12	ML12
ML12A-730RC	-	ML12A-730RC-JET



TOP-Line
731R

ML16	ML16	ML16
ML16A-730RC	ML16A-730RC-D	ML16A-730RC-JET-D

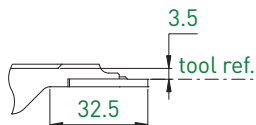

TOP-Line
731R

ML12	ML12	ML12
ML12A-730RC-R04	-	-
ML12A-730RC-SWISS-NANO	-	-



TOP-Line
751-757

ML12	ML12	ML12
ML12A-750-V	ML12A-750-V-D	ML12A-750-V-JET-D
ML16	ML16	ML16
ML16A-750-V	ML16A-750-V-D	ML16A-750-V-JET-D

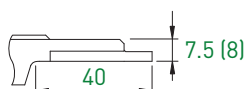

TOP-Line
751R

ML12	ML12	ML12 
ML12A-750RC	-	ML12A-750RC-JET
ML16	ML16	ML16
ML16A-750RC	ML16A-750RC-D	ML16A-750RC-JET-D



MODU-LINE

Porte-plaquettes – Coupe déportée & contre-opération
 WSP-Halter – Versetztes Schneiden & Gegenspindel
 Insert holders – Cut off line & cut on subspindle

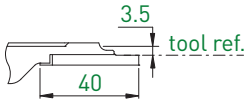
TOP-Line

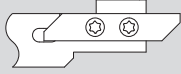

TOP-Line
751R

Standard	-D	-JET-D
		
Art. N°	Art. N°	Art. N°
ML12	ML12	ML12
ML12A-750RC-R04	-	-
ML12A-750RC-SWISS-NANO	-	-

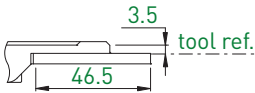

TOP-Line
771R



ML12	ML12	ML12
ML12A-770RC-SWISS-NANO	-	-

Porte-plaquettes – Contre-opération
 WSP-Halter – Gegenspindel
 Insert holders – Cut on subspindle

TURN-Line



TURN-Line
337-339

Standard	-D	-JET-D
		
Art. N°	Art. N°	Art. N°
ML12	ML12	ML12
ML12A-330-V	ML12A-330-V-D	ML12A-330-V-JET-D
ML16	ML16	ML16
ML16A-330-V	ML16A-330-V-D	ML16A-330-V-JET-D

Porte-plaquettes – Contre-opération

WSP-Halter – Gegenspindel

Insert holders – Cut on subspindle

ISO-Line

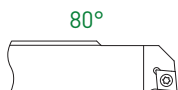

ISO-Line
CC...0602..

Standard	-D	-JET-D
Art. N°	Art. N°	Art. N°
ML12	ML12	ML12
-	ML12A-SCLCL06-V-D	ML12A-SCLCL06-V-JET-D
ML16	ML16	ML16
-	ML16A-SCLCL06-V-D	ML16A-SCLCL06-V-JET-D

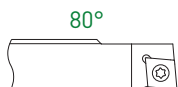

ISO-Line
CC...9T3..

ML12	ML12	ML12
-	ML12A-SCLCL09-V-D	ML12A-SCLCL09-V-JET-D
ML16	ML16	ML16
-	ML16A-SCLCL09-V-D	ML16A-SCLCL09-V-JET-D

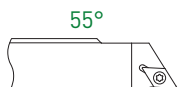

ISO-Line
DC...0702..

ML12	ML12	ML12
-	ML12A-SDJCL07-V-D	ML12A-SDJCL07-V-JET-D
ML16	ML16	ML16
-	ML16A-SDJCL07-V-D	ML16A-SDJCL07-V-JET-D

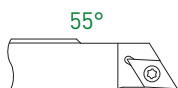

ISO-Line
DC...11T3..

ML12	ML12	ML12
ML12A-SDJCL11-V	ML12A-SDJCL11-V-D	ML12A-SDJCL11-V-JET-D
ML16	ML16	ML16
ML16A-SDJCL11-V	ML16A-SDJCL11-V-D	ML16A-SDJCL11-V-JET-D

MODU-LINE

Porte-plaquettes – Contre-opération

WSP-Halter – Gegenspindel

Insert holders – Cut on subspindle

ISO-Line

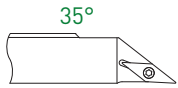

35°

ISO-Line
VC...-1103..

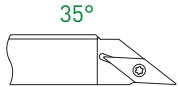

35°

ISO-Line
VC...-1303..

Standard	-D	-JET-D
Art. N°	Art. N°	Art. N°
ML12	ML12	ML12
ML12A-SVJCL11-V	ML12A-SVJCL11-V-D	ML12A-SVJCL11-V-JET-D
ML16	ML16	ML16
ML16A-SVJCL11-V	ML16A-SVJCL11-V-D	ML16A-SVJCL11-V-JET-D

ML12	ML12	ML12
-	ML12A-SVJCL13-V-D	-
ML16	ML16	ML16
-	ML16A-SVJCL13-V-D	ML16A-SVJCL13-V-JET-D

Porte-plaquettes – Coupe déportée

WSP-Halter – Versetztes Schneiden

Insert holders – Cut off line

EVO CUT-Line

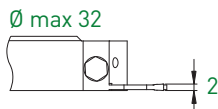

Ø max 32

EVO CUT-Line
ET20

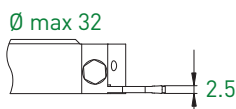

Ø max 32

EVO CUT-Line
ET25

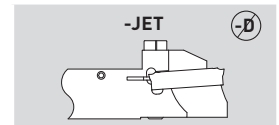

Art. N°	Art. N°	Art. N°
ML16	ML16	ML16
-	-	ML16A-ET20-V-JET32

ML16	ML16	ML16
-	-	ML16A-ET25-V-JET32

Porte-plaquettes – Coupe déportée

WSP-Halter – Versetztes Schneiden

Insert holders – Cut off line

EVOCUT-Line

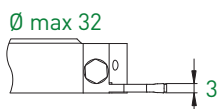

EVOCUT-Line
ET30

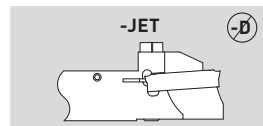

ML16	ML16	ML16
-	-	ML16A-ET30-V-JET32

Porte-plaquettes – Coupe déportée

WSP-Halter – Versetztes Schneiden

Insert holders – Cut off line

CUT-Line

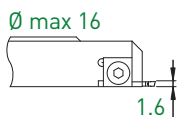

CUT-Line
CUT16

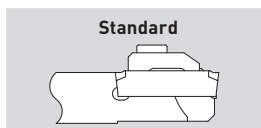

Art. N°	Art. N°	Art. N°
ML12	ML12	ML12
ML12A-CUT16-V	-	-
ML12F-CUT16-V	-	-
ML16	ML16	ML16
ML16A-CUT16-V	-	-
ML16F-CUT16-V	-	-

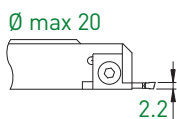

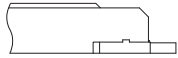

CUT-Line
CUT22

ML12	ML12	ML12
ML12A-CUT22-V	-	-
ML12F-CUT22-V	-	-
ML16	ML16	ML16
ML16A-CUT22-V	-	-
ML16F-CUT22-V	-	-



PRO-Line
632-636

Standard	-D	-JET-D
		
Art. N°	Art. N°	Art. N°
ML12	ML12	ML12
-	ML12A-630-V-D	ML12A-630-V-JET-D
ML16	ML16	ML16
-	ML16A-630-V-D	ML16A-630-V-JET-D

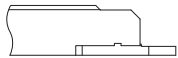

PRO-Line
651R

ML12	ML12	ML12
-	ML12A-650-V-D	ML12A-650-V-JET-D
ML16	ML16	ML16
-	ML16A-650-V-D	ML16A-650-V-JET-D

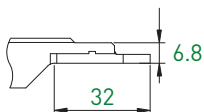

PRO-Line
651R

ML12	ML12	ML12
ML12A-650RC	ML12A-650RC-D	-
ML16	ML16	ML16
-	ML16A-650RC-D	ML16A-650RC-JET-D

Porte-plaquettes – Coupe déportée & contre-opération



WSP-Halter – Versetztes Schneiden & Gegenspindel

Insert holders – Cut off line & cut on subspindle

ECO-Line

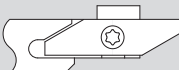

ECO-Line
251-261

Standard	-D	-JET-D
		
Art. N°	Art. N°	Art. N°
ML12	ML12	ML12
ML12A-250-V	ML12A-250-V-D	ML12A-250-V-JET-D
ML16	ML16	ML16
ML16A-250-V	ML16A-250-V-D	ML16A-250-V-JET-D

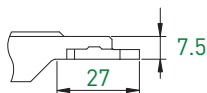

ECO-Line
251R

ML12	ML12	ML12
-	ML12A-250RC-D	-
ML16	ML16	ML16
-	ML16A-250RC-D	-

MODU-LINE

Modules d'arrosage
Kühlmittelzufuhrelemente
Coolant supply units

ML12 / ML16

ML12

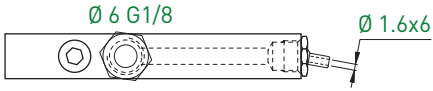

Raccord Anschluss Connection	Buses d'arrosage Kühlmitteldüse Coolant nozzles	ML12 Art. N°
Ø 6 G 1/8	5/16"	ML12-JET-5/16

ML16

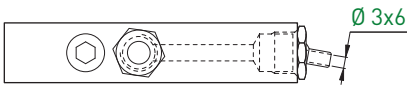

Raccord Anschluss Connection	Buses d'arrosage Kühlmitteldüse Coolant nozzles	ML16 Art. N°
Ø 6 G 1/8	7/16"	ML16-JET-7/16

buses optionnelles voir page 12.81
zusätzliche Düsen siehe Seite 12.81
optional nozzles see page 12.81

Modules de serrage
Spannelemente
Clamping units

ML12 / ML16

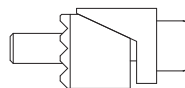
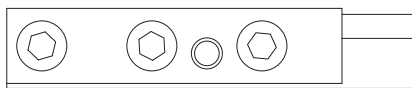

ML12 Art. N°	ML16 Art. N°
ML12-FIX-12/14	ML16-FIX-16/16
-	ML16-FIX-16/16.5
-	ML16-FIX-16/17
-	ML16-FIX-16/20
-	ML16-FIX-16/22
-	ML16-FIX-16/24

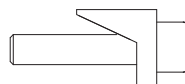
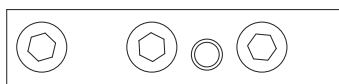

ML12 Art. N°	ML16 Art. N°
ML12-FIX-12	ML16-FIX-16

Buses d'arrosage

Kühlmitteldüsen

Coolant nozzles

5/16" / 7/16"

JET

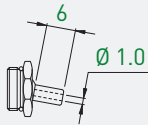
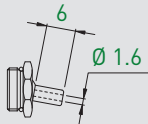
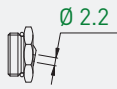
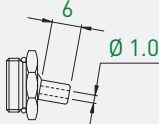
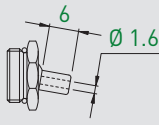
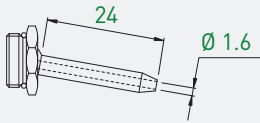
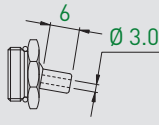
5/16"	Art. N°	Références compatibles Kompatible Artikeln Compatible items
	ML-JET 5/16-1.0X6	ML12-JET-5/1.6
	ML-JET 5/16-1.6X6	une buse ML-JET-5/16-1.6x6 est comprise eine Düse ML-JET-5/16-1.6x6 ist inbegriffen a nozzle ML-JET-5/16-1.6x6 is included
	ML-JET 5/16-2.2X0	
7/16"	Art. N°	Références compatibles Kompatible Artikeln Compatible items
	ML-JET 7/16-1.0X6	
	ML-JET 7/16-1.6X6	ML16-KMX26-JET ML16-JET-7/16 ML12-DEC010-JET ML16-DEC013-JET ML16-DEC020-JET ML16-S20-JET ML16-SWISS-ST26-JET
	ML-JET-7/16-1.6X24	une buse ML-JET-7/16-3.0x6 est comprise avec chaque article ci-dessus eine Düse ML-JET 7/16-3.0x6 ist mit jedem vorstehenden Artikel inbegriffen
	ML-JET-7/16-3.0X6	a nozzle ML-JET 7/16-3.0x6 is included with each above item

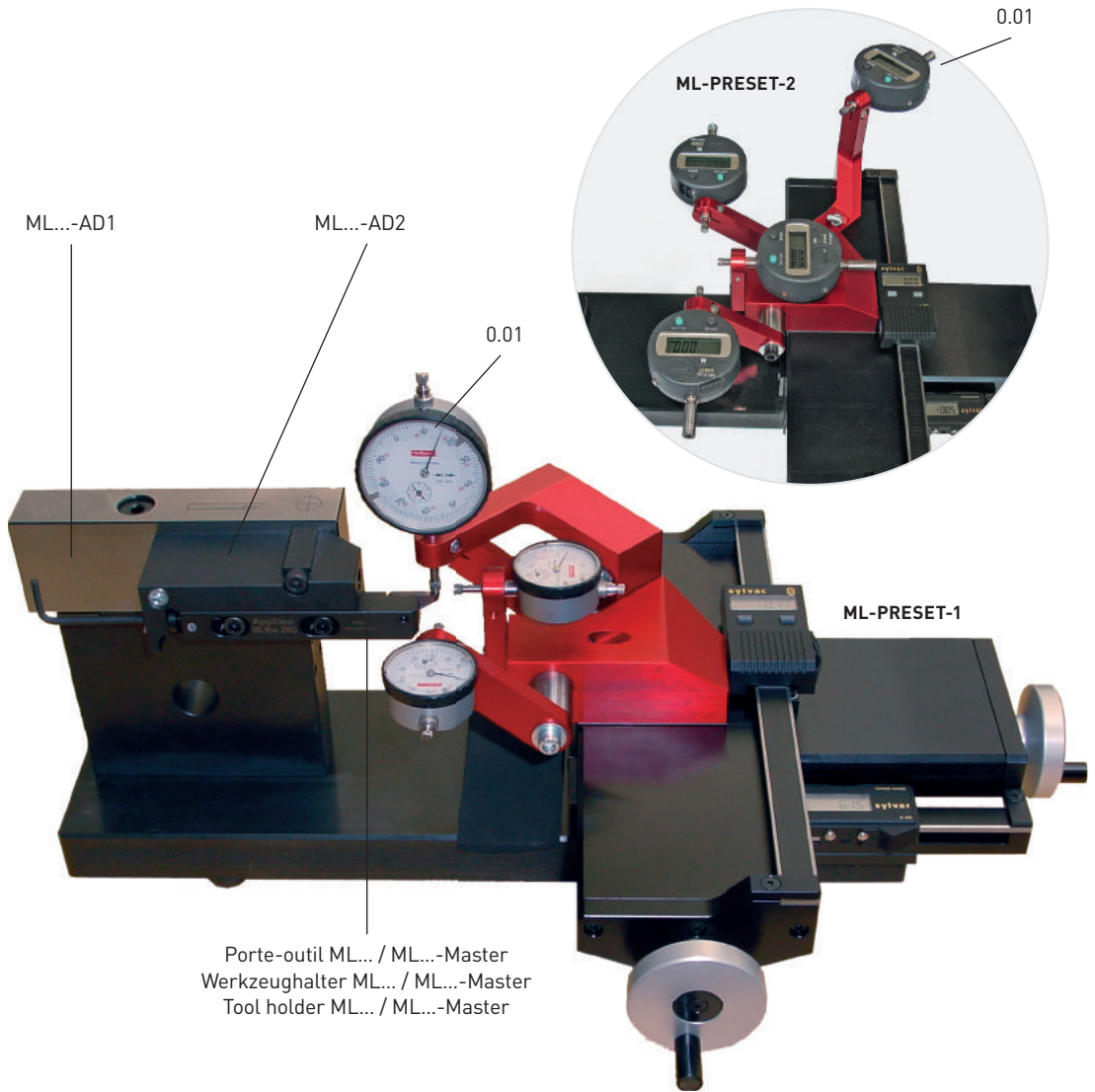

Art. N°

ML-PRESET-1

ML-PRESET-2

Banc de pré réglage

Voreinstellgerät

Presetting device

ML12 / ML16

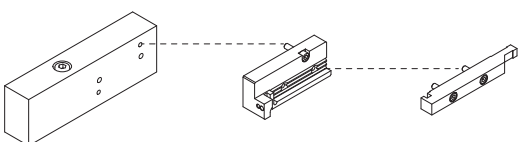
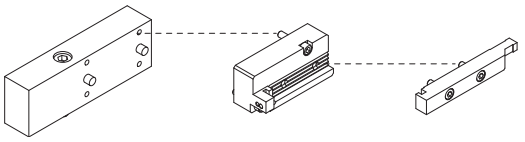
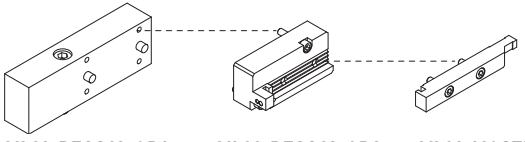
Type Typ Type	Fabricant Hersteller Manufacturer	Machines Maschinen Machines	Adaptateurs et jauges d'étalonnage Adapter und Einstelllehre Adaptators and master gauges
ML12	CITIZEN	C12/C16	 <p>ML12-AD1 ML12-AD2 ML12-MASTER</p>
		L12-1M7	
		L12-2M10	
		M16 V/VIII	
		R04	
		R07	
	HANWHA	XD20M	
	METAFIL	D3/D10/D13	
		SB-12RG	
	STAR	SR10-J	
		SW-12RII	
	TORNOS	DECO7/10 - EvoDECO 10	
		SwissNano/SwissNano 7	
		DT13	
CT20			
GT13			
TSUGAMI	B074		
	B075		
	P034		
ML16	CITIZEN	K12/K16/K12E/K16E	 <p>ML16/20-AD1 ML16-AD2 ML16-MASTER</p>
		L16/L20	
		L20E	
	HANWHA	SL12/16	
	MANUHRIN	KMX 426/526/626/Swing 20-26 MM	
		SA-12/SA-16/SA-16R	
		SB-16	
		SB-16/20RG	
		SB-20C/E	
		SR-20J/SR-20RIII	
		SR-20JII-A/B	
		SR-16R/SR-20R/SR-20RII	
		SR-20RIII/SR-20J	
		SR-20RIV	
		SR-32J	
		SV-12/20/ SV-20R	
		SW-20R	
		TORNOS	
	SIGMA20/32		
	DT26		
GT26			
GT32			
ML16	TORNOS	DECO13-EvoDECO16	 <p>ML16-DECO13-AD1 ML16-DECO13-AD2 ML16-MASTER</p>
ST26			

ML12

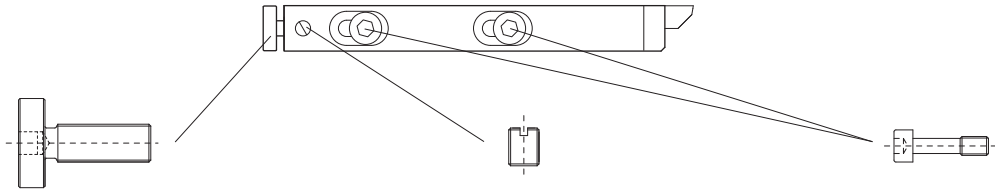

Vis de réglage
Einstellungsschraube
Setting screw

Art. N°

ML12A-M5X0.5

Vis de blocage
Blockierschraube
Locking screw

Art. N°

ML-M4X4-T

Vis de fixation
Befestigungsschraube
Fixing screw

Art. N°

ML12-M5XL20

ML16

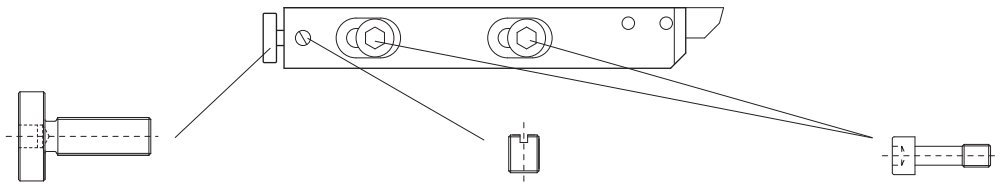

Vis de réglage
Einstellungsschraube
Setting screw

Art. N°

ML16A-M5X0.5

Vis de blocage
Blockierschraube
Locking screw

Art. N°

ML-M4X4-T

Vis de fixation
Befestigungsschraube
Fixing screw

Art. N°

ML16/20-M6XL20

Art. N°

ML-205004



Butée à ressort
Federnde Schraube
Spring bumper

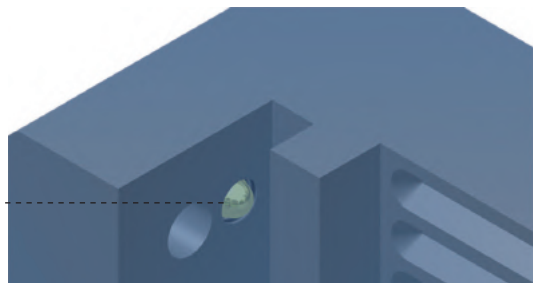





Pièces de rechange

Ersatzteile

Spare parts

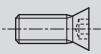
ML12 / ML16

Vis et clés pour le serrage des plaquettes
Schrauben und Schlüssel für WSP-Befestigung
Screws and keys for insert clamping

Porte-outils Halter Holders					
ML...250	V-M4X9-T15	C-T15	-	-	-
ML...260	V-M4X9-T15	C-T15	-	-	-
ML...330	V-M2.5X7.8-T8	C-T8	-	-	-
ML...340	V-M2.5X7.8-T8	C-T8	-	-	-
ML...630	V-M4X9-T15	C-T15	-	-	-
ML...640	V-M4X9-T15	C-T15	-	-	-
ML...650	V-M4X9-T15	C-T15	-	-	-
ML...650RC	V-M4X6.5-T15	C-T15	-	-	-
ML...660	V-M4X9-T15	C-T15	-	-	-
ML...730	V-M3X7-T8	C-T8	-	-	-
ML...730RC	V-M3X5.5-T8	C-T8	-	-	-
ML...730RC-R04	V-M3X4.5-T8 V-M3X7-T8	C-T8	-	-	-
ML...730RC-SWISS-NANO	V-M3X4.5-T8 V-M3X7-T8	C-T8	-	-	-
ML...740	V-M3X7-T8	C-T8	-	-	-
ML...750	V-M4X9-T15	C-T15	-	-	-
ML...750RC	V-M4X7.3-T15	C-T15	-	-	-
ML...750RC-R04	V-M4X5.6-T15 V-M4X7.3-T15	C-T15	-	-	-
ML...750RC-SWISS-NANO	V-M4X5.6-T15 V-M4X7.3-T15	C-T15	-	-	-
ML...760	V-M4X9-T15	C-T15	-	-	-
ML...770RC-SWISS-NANO	V-M4X7.3-T15	C-T15	-	-	-
ML...780	V-M4X9-T15	C-T15	-	-	-
ML...SC...06	V-M2.5X5.8-T8	C-T8	-	-	-
ML...SC...09	V-M4X7-T15-ISO	C-T15	-	-	-
ML...-SD...07	V-M2.5X7.8-T8	C-T8	-	-	-
ML...-SD...07-D	V-M2.5X5.8-T8	C-T8	-	-	-
ML12...-SDJ...11	V-M4X7-T15-ISO	C-T15	-	-	-
ML12...-SDN...11	V-M4X9-T15-ISO	C-T15	-	-	-
ML16...-SD...11	V-M4X9-T15-ISO	C-T15	-	-	-
ML...-SV...11	V-M2.5X7.8-T8	C-T8	-	-	-
ML...-SV...13	V-M3X7.3-T8-ISO	C-T8	-	-	-
ML...-CUT16	-	-	CUT16RS-SET	-	-
ML...-CUT16-V	-	-	CUT16LS-SET	-	-
ML...-CUT22	-	-	CUT22RS-SET	-	-
ML...-CUT16-V	-	-	CUT22LS-SET	-	-
ML16...-ET... JET32	-	-	-	-	-
ML16...-ET... V-JET32	-	-	-	V-M5X21-6P7-J	C-6PEX-7.0
ML...-BHK	V-BHK-M4X0.5-T8	-	-	-	-

**Outils et porte-outils
traditionnels pour le
décolletage et la
mécanique de précision**

- Porte-outils
- Forets à centrer
- Burins intérieurs
- Porte-molettes
- Molettes MD

**Übliche Werkzeuge
und Halter für
Decolletage und
Präzisionsmechanik**

- Werkzeughalter
- Zentrierbohrer
- Innendrehwerkzeuge
- Rändelhalter
- Rändelrädchen

**Usual tools and
tool holders for
automatic lathes and
precision mechanics**

- Tool holders
- Centring drills
- Internal turning tools
- Knurl holders
- Knurling wheels



Index

Porte-outils
Werkzeughalter
Tool holders

Type 14xx / 24xx



> 13.02

Porte-outils monoblocs pour machines Tornos
Monoblockwerkzeughalter für Tornos Maschinen
Monobloc tool holders for Tornos machines

Type 2435 / 2436



> 13.12

Forets à centrer plats
Zentrierflachbohrer
Centering flat drills

Type 1200 / 2200



> 13.14

Forets à centrer hélicoïdaux
Zentrierspiralbohrer
Centering twist drills

Type 15xx / 25xx



> 13.15

Burins intérieurs en métal dur
Vollhartmetall Innendrehwerkzeuge
Solid carbide internal turning tools

Type 16xx / 26xx



> 13.16

Porte-molettes
Rändelhalter
Knurl holders

Type 1402 / 2402



> 13.18

Molettes en métal dur
Vollhartmetall Rändelrädchen
Solid carbide knurling wheels

Type 1107



> 13.19

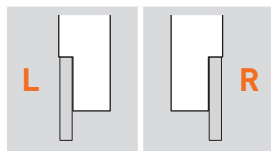
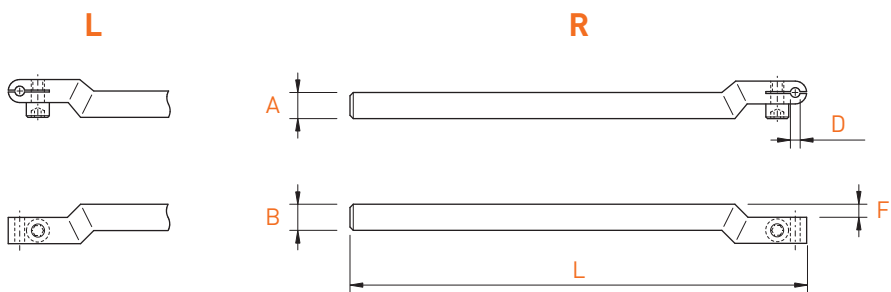

A x B	L	F	D	Art. N°	Art. N°
6 x 6	132	3	1.5	1400-J-615	2400-J-615
6 x 6	132	3	2.0	1400-J-620	2400-J-620
6 x 6	132	3	3.0	1400-J-630	2400-J-630
7 x 7	140	3	1.5	1400-J-715	2400-J-715
7 x 7	140	3	2.0	1400-J-720	2400-J-720
7 x 7	140	3	3.0	1400-J-730	2400-J-730
8 x 8	140	4	1.5	1400-J-815	2400-J-815
8 x 8	140	4	2.0	1400-J-820	2400-J-820
8 x 8	140	4	3.0	1400-J-830	2400-J-830

Porte-outils
 Werkzeughalter
 Tool holders

1401-K / 2401-K

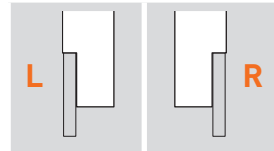
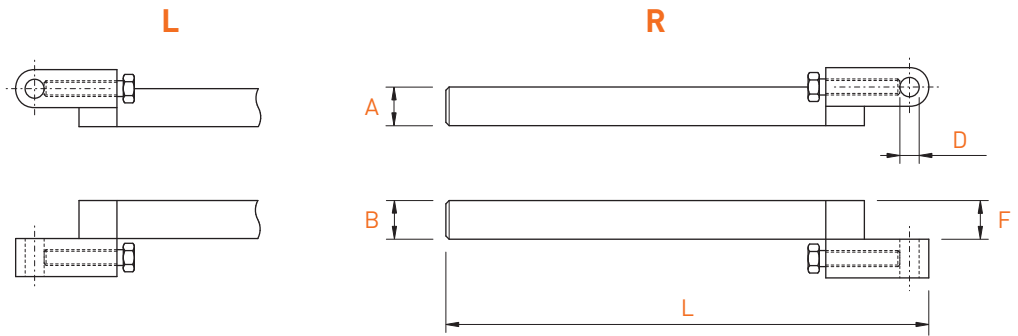

A x B	L	F	D	Art. N°	Art. N°
7 x 7	146	7	2.0	1401-K-720	-
7 x 7	146	7	3.0	1401-K-730	2401-K-730
7 x 7	146	7	4.0	1401-K-740	2401-K-740
8 x 8	146	8	2.0	1401-K-820	-
8 x 8	146	8	3.0	1401-K-830	2401-K-830
8 x 8	146	8	4.0	1401-K-840	2401-K-840
8 x 8	146	8	5.0	1401-K-850	2401-K-850
8 x 8	146	8	6.0	1401-K-860	2401-K-860
10 x 10	150	10	3.0	-	2401-K-1030
10 x 10	150	10	4.0	1401-K-1040	2401-K-1040
10 x 10	150	10	5.0	1401-K-1050	2401-K-1050
10 x 10	150	10	6.0	1401-K-1060	2401-K-1060
10 x 10	150	10	7.0	1401-K-1070	2401-K-1070
12 x 12	150	12	3.0	-	2401-K-1230
12 x 12	150	12	4.0	1401-K-1240	2401-K-1240
12 x 12	150	12	5.0	1401-K-1250	2401-K-1250
12 x 12	150	12	6.0	1401-K-1260	2401-K-1260
12 x 12	150	12	8.0	1401-K-1280	2401-K-1280
14 x 14	150	14	4.0	1401-K-1440	2401-K-1440
14 x 14	150	14	6.0	1401-K-1460	2401-K-1460
14 x 14	150	14	8.0	1401-K-1480	2401-K-1480

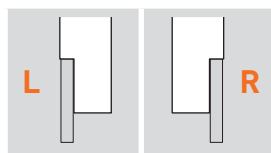
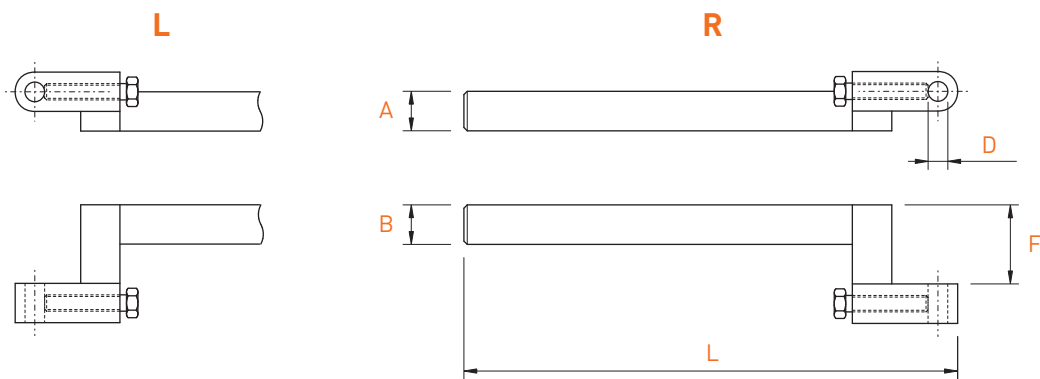

A x B	L	F	D	Art. N°	Art. N°
7 x 7	146	12	4.0	1420-7124	2420-7124
8 x 8	146	12	4.0	1420-8124	2420-8124
8 x 8	146	14	3.0	1420-8143	2420-8143
8 x 8	146	15	5.0	1420-8155	2420-8155
8 x 8	146	20	5.0	1420-8205	2420-8205
10 x 10	150	20	6.0	1420-10206	2420-10206
12 x 12	150	18	6.0	1420-12186	2420-12186
12 x 12	150	18	8.0	1420-12188	-
12 x 12	150	24	8.0	1420-12248	2420-12248
14 x 14	150	20	8.0	1420-14208	2420-14208
14 x 14	150	24	8.0	1420-14248	2420-14248

Porte-outils

Werkzeughalter

Tool holders

 $\square 12 \times 12$

1460

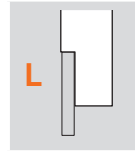
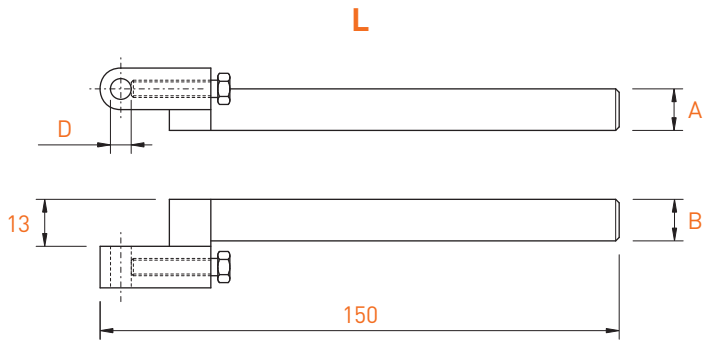

A x B	D	Art. N°
12 x 12	4.0	1460-4
12 x 12	5.0	1460-5
12 x 12	6.0	1460-6
12 x 12	8.0	1460-8

TOOLING-LINE

Porte-outils
Werkzeughalter
Tool holders

∅ 10 x 10

2450-SP

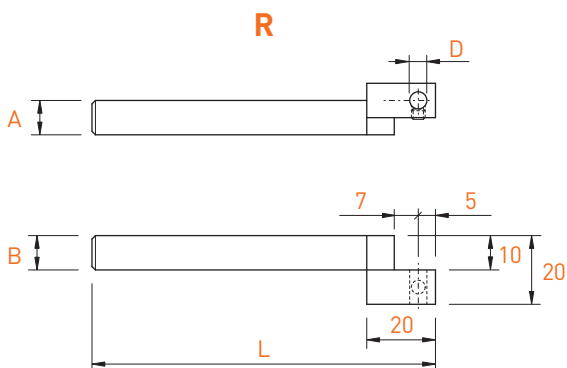

A x B	L	D	Art. N°
10 x 10	100	3.0	2450-SP-3
10 x 10	100	4.0	2450-SP-4
10 x 10	100	5.0	2450-SP-5
10 x 10	100	6.0	2450-SP-6
10 x 10	120	3.0	2450-SP-3-120
10 x 10	120	4.0	2450-SP-4-120
10 x 10	120	5.0	2450-SP-5-120
10 x 10	120	6.0	2450-SP-6-120

Porte-outils
Werkzeughalter
Tool holders

∅ 10 x 10

2470

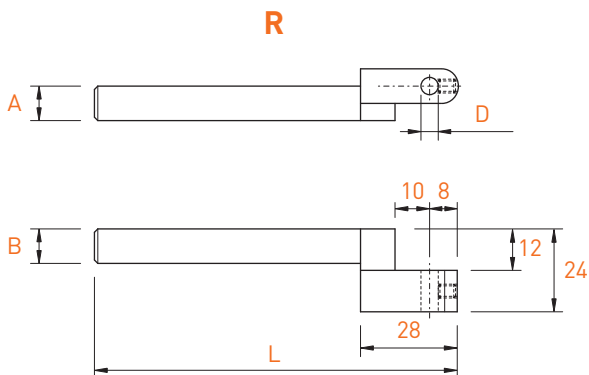

A x B	L	D	Art. N°
10 x 10	105	3.0	2470-3
10 x 10	105	4.0	2470-4
10 x 10	105	5.0	2470-5
10 x 10	105	6.0	2470-6
10 x 10	105	7.0	2470-7

Porte-outils
Werkzeughalter
Tool holders

∅ 12 x 12

2450

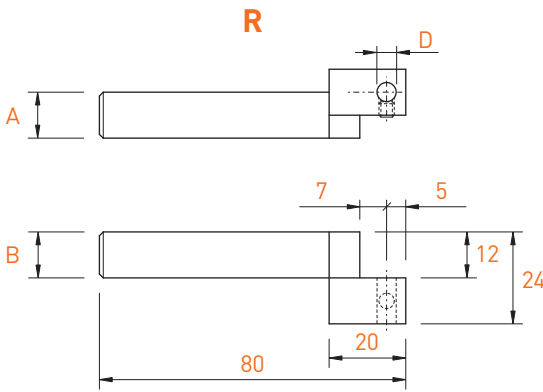

A x B	D	Art. N°
12 x 12	3.0	2450-3
12 x 12	4.0	2450-4
12 x 12	5.0	2450-5
12 x 12	6.0	2450-6
12 x 12	8.0	2450-8

Porte-outils
Werkzeughalter
Tool holders

∅ 12 x 12

2460

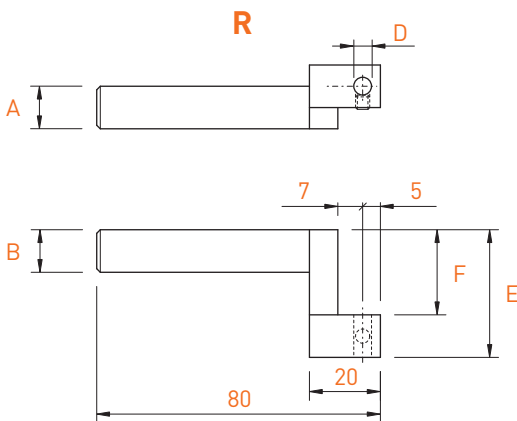

A x B	F	E	D	Art. N°
12 x 12	16	28	4.0	2460-284
12 x 12	16	28	6.0	2460-286
12 x 12	16	28	8.0	2460-288
12 x 12	20	32	4.0	2460-324
12 x 12	20	32	6.0	2460-326
12 x 12	20	32	8.0	2460-328
12 x 12	24	36	4.0	2460-364
12 x 12	24	36	6.0	2460-366
12 x 12	24	36	8.0	2460-368



A x B	L	F	D	Art. N°
8 x 8	120	8	3.0	2405-K-830
8 x 8	120	8	4.0	2405-K-840
8 x 8	120	8	5.0	2405-K-850
8 x 8	120	8	6.0	2405-K-860
10 x 10	100	10	4.0	2405-K-1040
10 x 10	100	10	5.0	2405-K-1050
10 x 10	100	10	6.0	2405-K-1060
12 x 12	150	12	4.0	2405-K-1240
12 x 12	150	12	6.0	2405-K-1260
12 x 12	150	12	8.0	2405-K-1280

Porte-outils

Werkzeughalter

Tool holders

2425



A x B	L	F	D	Art. N°
8 x 8	120	12	4.0	2425-8124
8 x 8	120	15	5.0	2425-8155
8 x 8	120	20	5.0	2425-8205
10 x 10	100	15	6.0	2425-10156
10 x 10	100	20	6.0	2425-10206
12 x 12	150	18	6.0	2425-12186
12 x 12	150	24	8.0	2425-12248

TOOLING-LINE

Porte-outils
Werkzeughalter
Tool holders

□ 12 x 16

2441



A x B	D	Art. N°
12 x 16	3.0	2441-0-3
12 x 16	4.0	2441-0-4
12 x 16	5.0	2441-0-5
12 x 16	6.0	2441-0-6

Porte-outils
Werkzeughalter
Tool holders

□ 16 x 16

2440-0

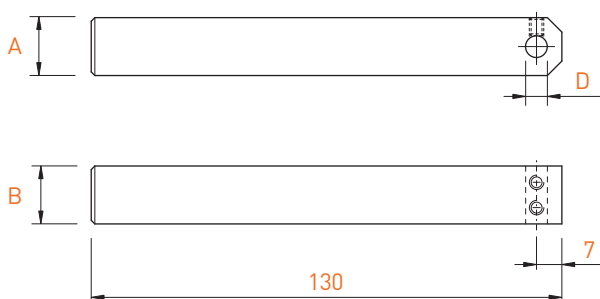

A x B	D	Art. N°
16 x 16	3.0	2440-0-3
16 x 16	4.0	2440-0-4
16 x 16	5.0	2440-0-5
16 x 16	6.0	2440-0-6

TOOLING-LINE

Porte-outils pour machines Tornos DECO 7/10 / EvoDECO 10

Werkzeughalter für Tornos DECO 7/10 / EvoDECO 10 Maschinen

Tool holders for Tornos DECO 7/10 / EvoDECO 10 machines

2435 / 2435-T

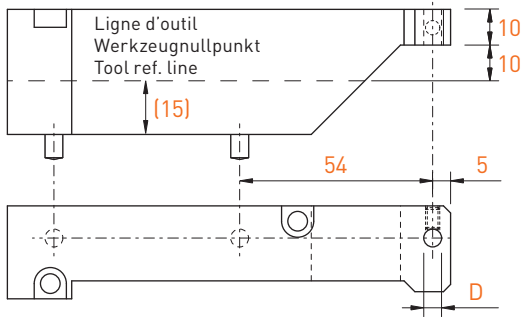

D	Art. N°
3.0	2435-3
4.0	2435-4
5.0	2435-5
6.0	2435-6

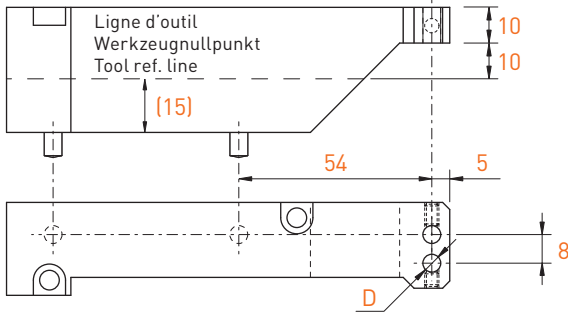

D	Art. N°
3.0	2435-3-T
4.0	2435-4-T
5.0	2435-5-T
6.0	2435-6-T

Porte-outils pour machines Tornos DECO 13 / EvoDECO 16

Werkzeughalter für Tornos DECO 13 / EvoDECO 16 Maschinen

Tool holders for Tornos DECO 13 / EvoDECO 16 machines

2436 / 2436T

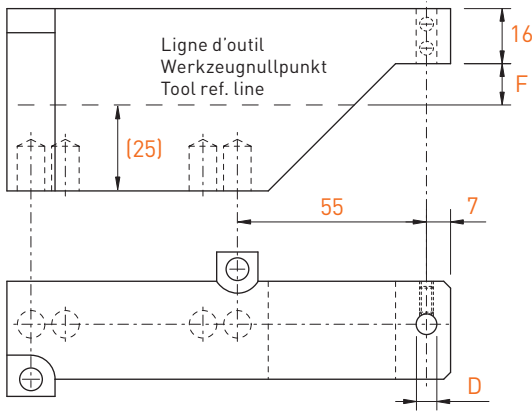

F	D	Art. N°
12	3.0	2436-12-3
12	4.0	2436-12-4
12	5.0	2436-12-5
12	6.0	2436-12-6
12	8.0	2436-12-8
18	3.0	2436-18-3
18	4.0	2436-18-4
18	5.0	2436-18-5
18	6.0	2436-18-6
18	8.0	2436-18-8

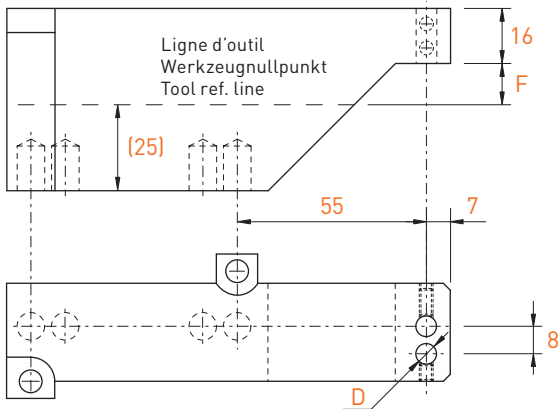

F	D	Art. N°
12	3.0	2436T-12-3
12	4.0	2436T-12-4
12	5.0	2436T-12-5
12	6.0	2436T-12-6
18	3.0	2436T-18-3
18	4.0	2436T-18-4
18	5.0	2436T-18-5
18	6.0	2436T-18-6

Entretroise

Erhöhungplatte

Spacer

2436-S12

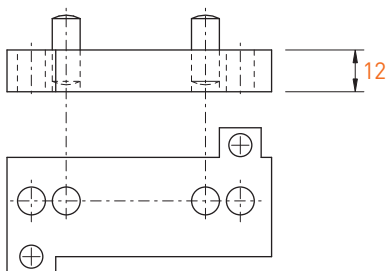

Art. N°

2436-S12

TOOLING-LINE

Forets à centrer plats

Zentrierflachbohrer

Centering flat drills

90°

1200 / 2200

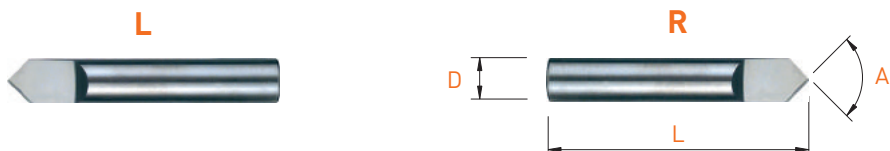

MD VHM HM			L	R
A	D	L	Art. N°	Art. N°
90°	3	17	1200-317	2200-317
90°	3	38	1200-338	2200-338
90°	4	40	1200-440	2200-440
90°	5	50	1200-550	2200-550
90°	6	50	1200-650	2200-650
90°	8	58	1200-858	2200-858
90°	10	66	1200-1066	2200-1066
90°	12	73	1200-1273	2200-1273

Forets à centrer hélicoïdaux
 Zentrierspiralbohrer
 Centering twist drills

90°

1500 / 2520

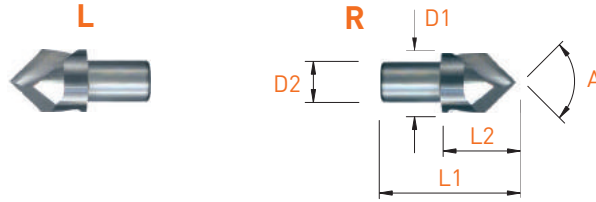

					HSS		MD / VHM / HM	
					L	R	L	R
A	D1	D2	L1	L2	Art. N°	Art. N°	Art. N°	Art. N°
90°	5	4	17	8	1500-5-HSS	2520-5-HSS	1500-5	2520-5
90°	7	5	17	8	1500-7-HSS	2520-7-HSS	1500-7	2520-7
90°	10	6	22	10	1500-10-HSS	2520-10-HSS	1500-10	2520-10
90°	12	8	26	12	1500-12-HSS	2520-12-HSS	1500-12	2520-12

Forets à centrer hélicoïdaux
 Zentrierspiralbohrer
 Centering twist drills

120°

1510 / 2530

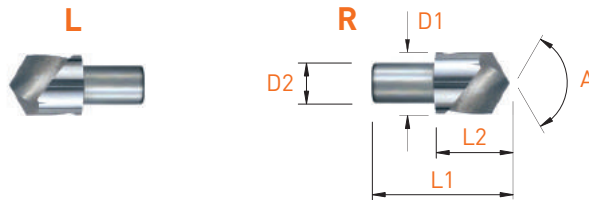

					MD VHM HM		L	R
A	D1	D2	L1	L2	Art. N°	Art. N°		
120°	5	4	17	8	1510-5	2530-5		
120°	7	5	17	8	1510-7	2530-7		
120°	10	6	22	10	1510-10	2530-10		
120°	12	8	26	12	1510-12	2530-12		

TOOLING-LINE

Burins intérieurs en métal dur
 Vollhartmetall Innendrehwerkzeuge
 Solid carbide internal turning tools

1600 / 2620

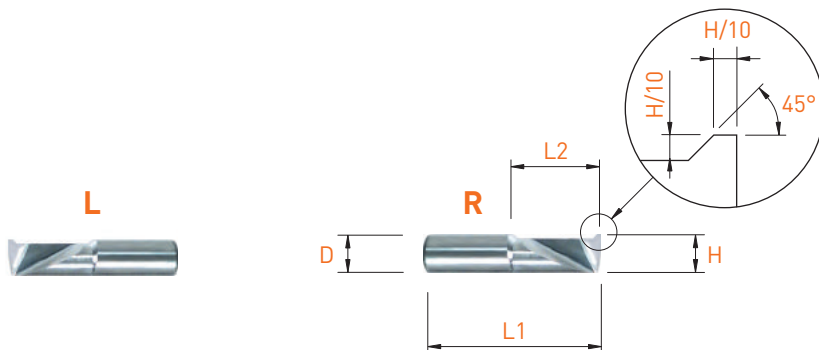

				L	R
				Art. N°	Art. N°
MD VHM HM	H 0/-0.05	D	L1	L2	
	2	3	13	4	1600-2-4 2620-2-4
	3	3	15	6	1600-3-6 2620-3-6
	4	4	17	8	1600-4-8 2620-4-8
	4	4	21	12	1600-4-12 2620-4-12
	5	5	21	10	1600-5-10 2620-5-10
	5	5	26	15	1600-5-15 2620-5-15
	6	6	25	12	1600-6-12 2620-6-12
	6	6	31	18	1600-6-18 2620-6-18
	8	8	32	16	1600-8-16 2620-8-16
	8	8	40	24	1600-8-24 2620-8-24

Burins intérieurs en métal dur
 Vollhartmetall Innendrehwerkzeuge
 Solid carbide internal turning tools

1610 / 2630

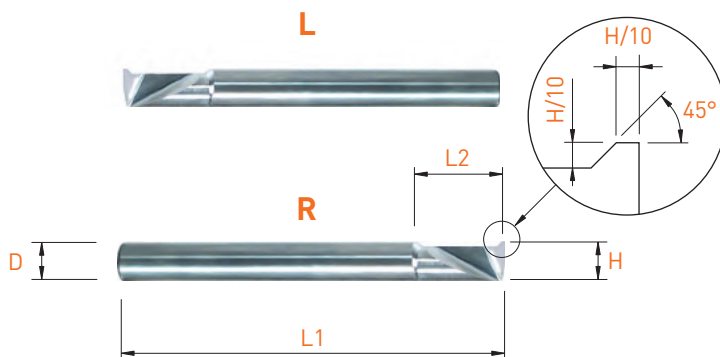

MD VHM HM				L	R
H 0/-0.05	D	L1	L2	Art. N°	Art. N°
2	3	38	4	1610-2-4	2630-2-4
3	3	38	6	1610-3-6	2630-3-6
4	4	40	8	1610-4-8	2630-4-8
4	4	40	12	1610-4-12	2630-4-12
5	5	50	10	1610-5-10	2630-5-10
5	5	54	15	1610-5-15	2630-5-15
6	6	50	12	1610-6-12	2630-6-12
6	6	57	18	1610-6-18	2630-6-18
8	8	58	16	1610-8-16	2630-8-16
8	8	63	24	1610-8-24	2630-8-24
10	10	72	30	-	2630-10-30
12	12	83	36	-	2630-12-36

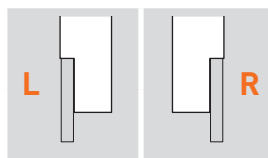
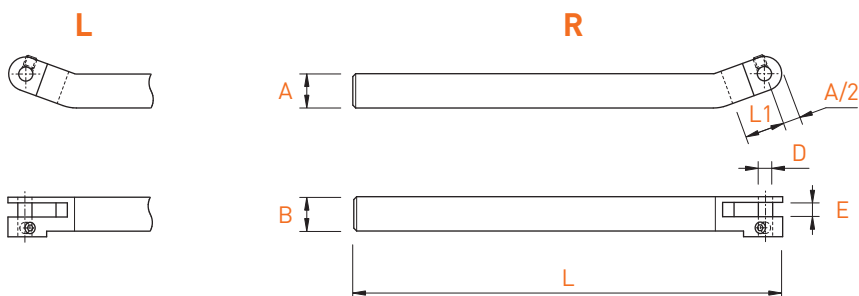

Pièces de rechange
Ersatzteile
Spare parts



A x B	L	E	D	L1	A/2	Art. N°	Art. N°	Art. N°
6 x 6	132	2	3	10	3	1402-623	2402-623	GP-3X10-A6H2.5
6 x 6	132	3	3	10	3	1402-633	2402-633	GP-3X10-A6H2.5
7 x 7	140	2	3	10	3.5	1402-723	2402-723	GP-3X12-A6H2.5
7 x 7	140	3	3	10	3.5	1402-733	2402-733	GP-3X12-A6H2.5
7 x 7	140	4	3	10	3.5	1402-743	2402-743	GP-3X12-A6H2.5
7 x 7	140	2	4	10	3.5	1402-724	2402-724	GP-4X12-A6H3.5
7 x 7	140	3	4	10	3.5	1402-734	2402-734	GP-4X12-A6H3.5
7 x 7	140	4	4	10	3.5	1402-744	2402-744	GP-4X12-A6H3.5
8 x 8	140	2	3	10	4	1402-823	2402-823	GP-3X12-A6H2.5
8 x 8	140	3	3	10	4	1402-833	2402-833	GP-3X12-A6H2.5
8 x 8	140	4	3	10	4	1402-843	2402-843	GP-3X12-A6H2.5
8 x 8	140	2	4	10	4	1402-824	2402-824	GP-4X12-A6H3.5
8 x 8	140	3	4	10	4	1402-834	2402-834	GP-4X12-A6H3.5
8 x 8	140	4	4	10	4	1402-844	2402-844	GP-4X12-A6H3.5
10 x 10	150	3	3	10	5	1402-1033	2402-1033	GP-3X14-A8H2.5
10 x 10	150	4	3	10	5	1402-1043	2402-1043	GP-3X14-A8H2.5
10 x 10	150	3	4	10	5	1402-1034	2402-1034	GP-4X14-A8H3.5
10 x 10	150	4	4	10	5	1402-1044	2402-1044	GP-4X14-A8H3.5
10 x 10	150	5	4	10	5	1402-1054	-	GP-4X14-A8H3.5
12 x 12	150	4	4	12	6	1402-1244	2402-1244	GP-4X14-A8H3.5
12 x 12	150	5	4	12	6	1402-1254	2402-1254	GP-4X14-A8H3.5
12 x 12	150	4	5	12	6	1402-1245	2402-1245	GP-5X14-A8H4.5
12 x 12	150	5	5	12	6	1402-1255	2402-1255	GP-5X14-A8H4.5
16 x 16	150	4	4	12	8	1402-1644	2402-1644	GP-4X16-A8H3.5
16 x 16	150	4	5	12	8	-	2402-1645	GP-5X16-A9H4.5
16 x 16	150	5	5	12	8	-	2402-1655	GP-5X16-A9H4.5
16 x 16	150	6	4	12	8	-	2402-1664	GP-4X16-A8H3.5
16 x 16	150	6	6	12	8	-	2402-1666	GP-6X16-A9H5.5
16 x 16	150	8	6	12	8	-	2402-1686	GP-6X16-A9H5.5

Molettes en métal dur

Vollhartmetall Rändelrädchen

Solid carbide knurling wheels

1107

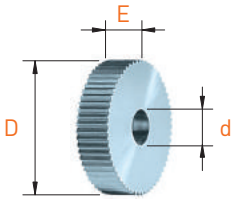

AA



BL

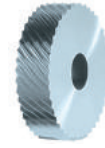

BR

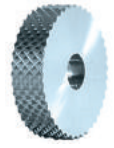

GE

Molettes standards Standard Rändelrädchen Standard knurls	D	E	d	Pas (tous les 0.1 mm) Teilung (alle 0.1 mm) Pitch (every 0.1 mm)	
AA (0°)	8	2	3	0.2 - 0.6	
	8	2	4	0.2 - 0.6	
	8	3	3	0.2 - 0.6	
	8	3	4	0.2 - 0.6	
	8	4	3	0.2 - 0.6	
	8	4	4	0.2 - 0.6	
	10	2	3	0.2 - 0.8	
	10	2	4	0.2 - 0.8	
	10	3	3	0.2 - 0.8	
	BL 15° / BR 15° BL 30° / BR 30° BL 45° / BR 45°	10	3	4	0.2 - 0.8
		10	4	3	0.2 - 0.8
		10	4	4	0.2 - 0.8
		10	4	4	0.2 - 0.8
	GE 30° GE 45°	12	4	4	0.3 - 1.0
		15	4	4	0.4 - 1.0
		15	4	5	0.4 - 1.0
		15	5	4	0.4 - 1.0
		15	5	5	0.4 - 1.0
20		4	5	0.5 - 1.2	
20		5	5	0.5 - 1.2	
20		6	6	0.5 - 1.2	
20	8	6	0.5 - 1.2		

Molettes "Quick" "Quick"-Rändelrädchen "Quick"-knurling wheels	D	E	d	Pas (tous les 0.1 mm) Teilung (alle 0.1 mm) Pitch (every 0.1 mm)
AA (0°)	8.9	2.5	4	0.2 - 0.8
BL 15° / BR 15°	14.5	3	5	0.4 - 1.0
BL 30° / BR 30°	21.5	5	8	0.5 - 1.2

Exécutions spéciales sur demande
Sonderausführungen auf Anfrage
Special executions on request

MICRO-LINE

APPLITEC



Index

Nuances
Sorten
Grades > 14.02

Micro-fraises de précision
Mikropräzisionsfräser
Precision micro end mills



> 14.04

Fraises en bout de finition
Schlicht Schaftfräser
Finishing end mills



> 14.51

Fraises à graver
Gravierfräser
Engraving mills

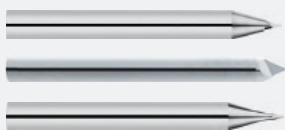

> 14.98

Micro-forets et centreurs
Mikrobohrer und Zentrierbohrer
Micro drills and centering drills



> 14.104

Informations techniques et symboles
Technische Informationen und Symbole
Technical information and symbols

> 14.126

Nuances

Sorten

Grades

new

N

Non revêtu
Unbeschichtet
Uncoated

- Carbures de haute qualité et spécifiques selon les groupes produits
- Tous les carbures ont une excellente dureté et résistance à la flexion exceptionnelle
- Acuité d'arête maximale grâce à une finition super polie
- Idéal pour l'usinage en super finition de matières non ferreuses ou faiblement alliées

- Hochqualität und spezifische Hartmetalle gemäß den Produktgruppen
- Alle Hartmetalle haben eine ausgezeichnete Härte und außergewöhnliche Biegefestigkeit
- Maximale Kantenschärfe durch hochpoliertes Finish
- Ideal für superfinish Bearbeitung von Nichteisen- oder niedriglegierten Materialien

- High quality and specific carbides according to the product groups in our catalog
- All carbides have excellent hardness and exceptional flexural strength
- Maximum edge sharpness thanks to a super polished tool finish
- Ideal for super-finish machining of non-ferrous or low-alloy materials

TiAlN

Revêtement PDV à couche mince
Dünnschicht PVD Beschichtung
Thin PVD coating

- Revêtement de dernière génération couche mince et lisse
- Idéal pour tous les aciers et aciers inoxydables
- Bonne condition pour les grades de titane et alliage de nickel
- Excellente variante universelle pour un fraisage en finition ou ébauche
- Très bonne résistance à la température

- Neuesten Generation Beschichtung, dünne und glatte Schicht
- Hervorragend für alle Stähle und rostfreie Stähle
- Guter Zustand für Titan- und Nickellegierungsorten
- Ausgezeichnete Universalsorte zum Schlicht- oder Schruppfräsen
- Sehr gute Temperaturbeständigkeit

- Latest generation coating thin and smooth layer
- Specially adapted for our tools Ideal for all basic steels and stainless steels
- Good condition for Titan grades and Nickel alloy
- Excellent universal variant for finishing or rough milling
- Very good temperature resistance

STF

Revêtement PDV à couche mince
Dünnschicht PVD Beschichtung
Thin PVD coating

- Revêtement haute performance
- Premier choix pour les alliages de chrome/nickel, inox, titane, zirkonium
- Spécialement adapté aux matières extrêmes en générale

- Hochleistungsbeschichtung
- Erste Wahl für Chrom/ Nickel, rostfreier Stahl, Titan, Zirkoniumlegierungen
- Speziell angepasst für extreme Materialien im Allgemeinen

- High performance coating
- First choice for chrome/nickel, stainless steel, titan, zirkonium alloys
- Specially adapted to extreme materials in general

Nuances

Sorten

Grades

TiCN

Revêtement PDV à couche mince
Dünnschicht PVD Beschichtung
Thin PVD coating

- Revêtement de dernière génération, excellente adhérence couche mince et lisse
- Idéal pour le fraisage en finition de tous les aciers et aciers inoxydables
- Excellente nuance pour les outils de petits diamètres (0.02-0.90 mm)

- Neuesten Generation Beschichtung, dünne und glatte Schicht
- Hervorragend für Schlichtfräsen aller Stähle und rostfreien Stähle
- Ausgezeichnete Sorte für Werkzeuge mit kleinem Durchmesser (0.02-0.90 mm)

- Latest generation coating excellent adhesion thin and smooth layer
- Specially adapted for small diameters (0.02-0.90 mm)
- Ideal for finish milling for all steels and stainless steel

DLC

Revêtement DLC à couche mince
Dünnschicht DLC Beschichtung
Thin DLC coating







- Revêtement très haute performance couche extra mince
- Très faible coefficient de frottement
- Premier choix pour toutes les matières précieuses, non ferreuse et abrasives, telles que or, argent, laiton sans plomb, cuivre, aluminium, fibre de carbone, nacre et divers polymères...
- Angles de coupe parfaitement lisses et excellente acuité d'arrête
- Durée de vie de l'outil démultipliée

- Extra Dünnschicht Hochleistungsbeschichtung
- Sehr geringer Reibwert
- Erste Wahl für alle edlen, NE- und abrasiven Materialien wie Gold, Silber, bleifreies Messing, Kupfer, Aluminium, Kohlefaser, Perlmutter und diverse Polymere...
- Perfekt glatte Schnittwinkel und hervorragende Kantenschärfe
- Erhöhte Lebensdauer des Werkzeugs

- Very high-performance coating extra thin layer
- Very low ratio
- First choice for all precious, non-ferrous and abrasive materials, such as gold, silver, lead-free brass, copper, aluminum, carbon fiber, mother-of-pearl and various polymers...
- Perfectly smooth cutting angles and excellent edge sharpness
- Increased tool life

Paramètres de coupe indicatif
Empfohlene Schnittwerte
Standard machining data

14.06

 Sharp Corner  Radius Corner	Micro-fraises avec angles vifs Mikropräzisionsfräser mit scharfkantigen Ecken Micro end mills with sharp corners						
	Z	λ	L2	D1	D2	Type	page
	Z=1	0°	2x D1	00.20 - 3.00	03h4 / 04h5	3170-2	14.07
			2x D1	00.20 - 3.00	03h4 / 04h5	3170R-2	14.08
			3x D1	00.20 - 3.00	03h4 / 04h5	3170R-3	14.09
			4x D1	00.30 - 3.00	03h4 / 04h5	3170R-4	14.10
	Z=2	30°	0.75x D1	00.20 - 2.00	03h4	3271-0.75	14.11
			1x D1	00.30 - 2.50	03h4	3271-1	14.12
			1.5x D1	00.10 - 2.00	03h4	3271-1.5	14.13
			2x D1	00.10 - 2.00	03h4	3271-2	14.14
			3x D1	00.10 - 2.90	03h4	3271-3	14.15
			5x D1	00.30 - 2.50	03h4	3271-5	14.16
			8x D1	00.40 - 2.50	03h4 / 04h5	3271-8	14.17
			2x D1	00.20 - 3.00	03h4 / 06h5	3270S-3X	14.18 new
			2x D1	00.30 - 3.00	03h4 / 06h5	3270S-6X	14.19 new
			2x D1	00.40 - 3.00	03h4 / 06h5	3270S-9X	14.20 new
			2x D1	00.30 - 3.00	03h4 / 06h5	3279T-3X	14.21 new
			2x D1	00.30 - 3.00	03h4 / 06h5	3279T-6X	14.22 new
2x D1	00.40 - 3.00	03h4 / 06h5	3279T-9X	14.23 new			
	Z=3	30°	1.3x D1	00.30 - 2.90	03h4	3371-1.3	14.24
			2x D1	00.30 - 2.90	03h4	3371-2	14.25
			3x D1	00.30 - 2.90	03h4	3371-3	14.26
			4x D1	00.30 - 2.90	03h4	3371-4	14.27
			5x D1	00.50 - 2.50	03h4	3371-5	14.28
			8x D1	00.50 - 2.50	03h4 / 04h5	3371-8	14.29
		45°	2.5x D1	00.30 - 2.90	03h4	3375-2.5	14.30
			1.5x D1	00.30 - 2.50	03h4	DHD3371-1.5	14.31
		36°-38°-40°	3x D1	00.30 - 2.50	03h4	DHD3371-3	14.32
			2x D1	00.30 - 3.00	03h4 / 06h5	3370S-3X	14.33 new
			2x D1	00.30 - 3.00	03h4 / 06h5	3370S-6X	14.34 new
			2x D1	00.40 - 3.00	03h4 / 06h5	3370S-9X	14.35 new
2x D1	00.30 - 3.00		03h4 / 06h5	3379T-3X	14.36 new		
2x D1	00.30 - 3.00		03h4 / 06h5	3379T-6X	14.37 new		
30°	2x D1	00.30 - 3.00	03h4 / 06h5	3379T-9X	14.38 new		
	1.5x D1	00.30 - 2.90	03h4	3471-1.5	14.39		
Z=4	30°	3x D1	00.30 - 2.90	03h4	3471-3	14.40	
		3x D1	00.50 - 2.50	03h4	DHP3471-3	14.41	
	35°-38°	2x D1	00.30 - 2.90	03h4	3472-2	14.42	
		4x D1	00.40 - 2.90	03h4	3472-4	14.43	
	40°	2x D1	00.30 - 2.90	03h4	3472-2	14.42	
		4x D1	00.40 - 2.90	03h4	3472-4	14.43	

Micro-fraises de précision

Mikropräzisionsfräser

Precision micro end mills

Index

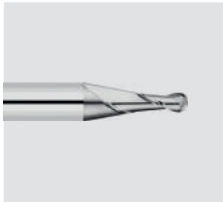
U	Micro-fraises hémisphériques Vollradius Mikropräzisionsfräser Ball nose micro end mills						
	Z	λ	L2	Range	D2	Type	page
	Z = 2	30°	0.75x D1	Ø0.20 - 2.50	Ø3h4	3278-0.75	14.44
			1x D1	Ø0.20 - 2.90	Ø3h4	3278-1	14.45
			1.5x D1	Ø0.20 - 2.90	Ø3h4	3278-1.5	14.46
			3x D1	Ø0.20 - 2.90	Ø3h4	3278-3	14.47
			1.5x D1	Ø0.20 - 3.00	Ø3h4 / Ø6h5	3278H-3X	14.48 new
			1.5x D1	Ø0.30 - 3.00	Ø3h4 / Ø6h5	3278H-6X	14.49 new
			1.5x D1	Ø0.40 - 3.00	Ø3h4 / Ø6h5	3278H-9X	14.50 new

Matière Werkstoff Material	VC	0.10 - 0.50	0.60 - 1.50	1.60 - 2.90	Z	TiAlN	STF	TiCN	DLC	
	(m/min)	fz (mm)	fz (mm)	fz (mm)						
Acier de décolletage Automatenstahl Free-cutting steel	P	80 - 130	0.003 - 0.005	0.006 - 0.010	0.013 - 0.020	-	***	***	**	-
Acier Stahl Steel	< 600 N/mm ² P	70 - 100	0.003 - 0.005	0.006 - 0.010	0.013 - 0.020	-	***	***	**	-
Acier Stahl Steel	< 800 N/mm ² P	70 - 100	0.003 - 0.005	0.006 - 0.010	0.013 - 0.020	-	***	***	**	-
Acier Stahl Steel	> 800 N/mm ² P	50 - 80	0.003 - 0.005	0.006 - 0.010	0.013 - 0.020	-	***	***	**	-
Acier trempé Gehärteter Stahl Hardened steel	-55HRC H	60 - 90	0.001 - 0.002	0.003 - 0.005	0.007 - 0.010	-	***	***	*	-
Acier trempé Gehärteter Stahl Hardened steel	+55HRC H	40 - 70	0.001 - 0.002	0.003 - 0.005	0.007 - 0.010	-	***	***	*	-
Inox Rostfreistahl Stainless steel	M	40 - 80	0.003 - 0.005	0.006 - 0.010	0.013 - 0.020	-	***	***	**	-
Aluminium	N	200 - 300	0.002 - 0.005	0.005 - 0.010	0.010 - 0.030	***	-	-	**	***
Cuivre, laiton, bronze Kupfer, Messing, Bronze Copper, brass, bronze	N	100 - 200	0.001 - 0.005	0.006 - 0.010	0.010 - 0.015	***	**	**	**	***
Matière synthétique Synthetisches Material Synthetic material	N	200 - 700	0.002 - 0.004	0.006 - 0.015	0.015 - 0.050	***	**	**	**	***
Métaux précieux Edelmetalle Precious metals	N	90 - 140	0.002 - 0.003	0.004 - 0.012	0.012 - 0.025	***	**	**	*	***
Titane Titan Titanium	S	25 - 70	0.001 - 0.003	0.004 - 0.010	0.006 - 0.015	-	***	***	**	-
Alliage de nickel Nickel-Legierung Nickel alloy	S	40 - 70	0.001 - 0.003	0.004 - 0.008	0.008 - 0.012	-	***	***	**	-
Matière exotique Exotisches material Exotic material	O	15 - 25	0.001 - 0.002	0.003 - 0.005	0.006 - 0.010	-	***	***	**	***

Avec revêtement, augmenter les valeurs de 20-30%
Mit Beschichtung, Daten um 20-30% erhöhen
With coating, increase data by 20-30%

* Bien / Gut / Good
** Très bien / Sehr Gut / Very good
*** Excellent / Ausgezeichnet / Excellent

Micro-fraises de précision

Mikropräzisionsfräser

Precision micro end mills

3170-2

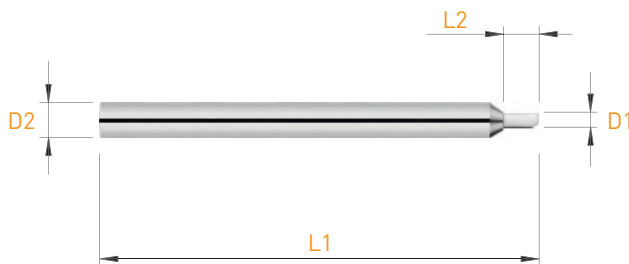

D1 +0.005 / -0.010	L2	D2 h4 03.0 h5 04.0	L1	Art. N°	Z	TiAIN	STF	TiCN	DLC
0.20	0.40	3.00	39	3170-2-0.20	■				
0.30	0.60	3.00	39	3170-2-0.30	■	■	■	■	■
0.40	0.80	3.00	39	3170-2-0.40	■	■	■	■	■
0.50	1.00	3.00	39	3170-2-0.50	■	■	■	■	■
0.60	1.20	3.00	39	3170-2-0.60	■	■	■	■	■
0.70	1.40	3.00	39	3170-2-0.70	■	■	■	■	■
0.80	1.60	3.00	39	3170-2-0.80	■	■	■	■	■
0.90	1.80	3.00	39	3170-2-0.90	■	■	■	■	■
1.00	2.00	3.00	39	3170-2-1.00	■	■	■	■	■
1.10	2.20	3.00	39	3170-2-1.10	■	■	■	■	■
1.20	2.40	3.00	39	3170-2-1.20	■	■	■	■	■
1.30	2.60	3.00	39	3170-2-1.30	■	■	■	■	■
1.40	2.80	3.00	39	3170-2-1.40	■	■	■	■	■
1.50	3.00	3.00	39	3170-2-1.50	■	■	■	■	■
1.60	3.20	3.00	39	3170-2-1.60	■	■	■	■	■
1.70	3.40	3.00	39	3170-2-1.70	■	■	■	■	■
1.80	3.60	3.00	39	3170-2-1.80	■	■	■	■	■
1.90	3.80	3.00	39	3170-2-1.90	■	■	■	■	■
2.00	4.00	3.00	39	3170-2-2.00	■	■	■	■	■
2.10	4.20	3.00	39	3170-2-2.10	■	■	■	■	■
2.20	4.40	3.00	39	3170-2-2.20	■	■	■	■	■
2.30	4.60	3.00	39	3170-2-2.30	■	■	■	■	■
2.40	4.80	3.00	39	3170-2-2.40	■	■	■	■	■
2.50	5.00	3.00	39	3170-2-2.50	■	■	■	■	■
2.60	5.20	3.00	39	3170-2-2.60	■	■	■	■	■
2.70	5.40	3.00	39	3170-2-2.70	■	■	■	■	■
2.80	5.60	3.00	39	3170-2-2.80	■	■	■	■	■
2.90	5.80	3.00	39	3170-2-2.90	■	■	■	■	■
3.00	6.00	4.00	40	3170-2-3.00	■	■	■	■	■

MICRO-LINE

Micro-fraises de précision

Mikropräzisionsfräser

Precision micro end mills

3170R-2

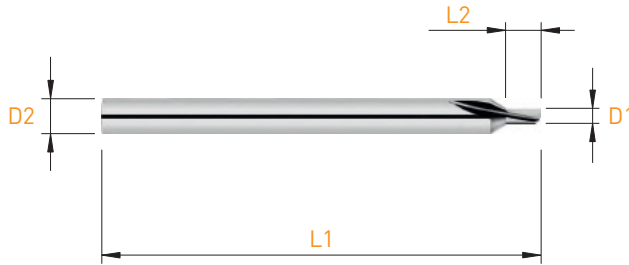

D1 +0.005 / -0.010	L2	D2 h4 Ø3.0 h5 Ø4.0	L1	Art. N°	Z	TiAlN	STF	TiCN	DLC
0.20	0.40	3.00	39	3170R-2-0.20	■				
0.30	0.60	3.00	39	3170R-2-0.30	■	■	■	■	■
0.40	0.80	3.00	39	3170R-2-0.40	■	■	■	■	■
0.50	1.00	3.00	39	3170R-2-0.50	■	■	■	■	■
0.60	1.20	3.00	39	3170R-2-0.60	■	■	■	■	■
0.70	1.40	3.00	39	3170R-2-0.70	■	■	■	■	■
0.80	1.60	3.00	39	3170R-2-0.80	■	■	■	■	■
0.90	1.80	3.00	39	3170R-2-0.90	■	■	■	■	■
1.00	2.00	3.00	39	3170R-2-1.00	■	■	■	■	■
1.10	2.20	3.00	39	3170R-2-1.10	■	■	■	■	■
1.20	2.40	3.00	39	3170R-2-1.20	■	■	■	■	■
1.30	2.60	3.00	39	3170R-2-1.30	■	■	■	■	■
1.40	2.80	3.00	39	3170R-2-1.40	■	■	■	■	■
1.50	3.00	3.00	39	3170R-2-1.50	■	■	■	■	■
1.60	3.20	3.00	39	3170R-2-1.60	■	■	■	■	■
1.70	3.40	3.00	39	3170R-2-1.70	■	■	■	■	■
1.80	3.60	3.00	39	3170R-2-1.80	■	■	■	■	■
1.90	3.80	3.00	39	3170R-2-1.90	■	■	■	■	■
2.00	4.00	3.00	39	3170R-2-2.00	■	■	■	■	■
2.10	4.10	3.00	39	3170R-2-2.10	■	■	■	■	■
2.20	4.40	3.00	39	3170R-2-2.20	■	■	■	■	■
2.30	4.60	3.00	39	3170R-2-2.30	■	■	■	■	■
2.40	4.80	3.00	39	3170R-2-2.40	■	■	■	■	■
2.50	5.00	3.00	39	3170R-2-2.50	■	■	■	■	■
2.60	5.20	3.00	39	3170R-2-2.60	■	■	■	■	■
2.70	5.40	3.00	39	3170R-2-2.70	■	■	■	■	■
2.80	5.60	3.00	39	3170R-2-2.80	■	■	■	■	■
2.90	5.80	3.00	39	3170R-2-2.90	■	■	■	■	■
3.00	6.00	4.00	40	3170R-2-3.00	■	■	■	■	■

Micro-fraises de précision

Mikropräzisionsfräser

Precision micro end mills

3170R-3

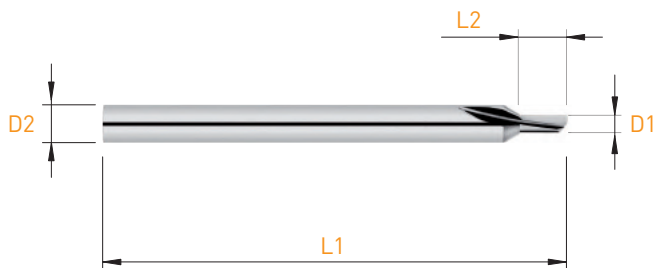

D1 +0.005 / -0.010	L2	D2 h4 Ø3.0 h5 Ø4.0	L1	Art. N°	Z	TiAlN	STF	TiCN	DLC
0.20	0.60	3.00	39	3170R-3-0.20	■				
0.30	0.90	3.00	39	3170R-3-0.30	■	■	■	■	■
0.40	1.20	3.00	39	3170R-3-0.40	■	■	■	■	■
0.50	1.50	3.00	39	3170R-3-0.50	■	■	■	■	■
0.60	1.80	3.00	39	3170R-3-0.60	■	■	■	■	■
0.70	2.10	3.00	39	3170R-3-0.70	■	■	■	■	■
0.80	2.40	3.00	39	3170R-3-0.80	■	■	■	■	■
0.90	2.70	3.00	39	3170R-3-0.90	■	■	■	■	■
1.00	3.00	3.00	39	3170R-3-1.00	■	■	■	■	■
1.10	3.30	3.00	39	3170R-3-1.10	■	■	■	■	■
1.20	3.60	3.00	39	3170R-3-1.20	■	■	■	■	■
1.30	3.90	3.00	39	3170R-3-1.30	■	■	■	■	■
1.40	4.20	3.00	39	3170R-3-1.40	■	■	■	■	■
1.50	4.50	3.00	39	3170R-3-1.50	■	■	■	■	■
2.00	6.00	3.00	39	3170R-3-2.00	■	■	■	■	■
2.50	7.50	3.00	39	3170R-3-2.50	■	■	■	■	■
3.00	9.00	4.00	40	3170R-3-3.00	■	■	■	■	■

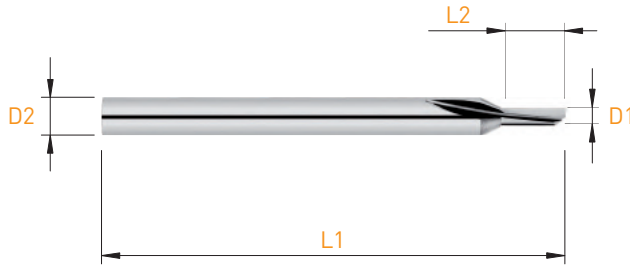

D1 +0.005 / -0.010	L2	D2 h4 03.0 h5 04.0	L1	Art. N°	Z	TiAlN	STF	TiCN	DLC
0.30	1.20	3.00	39	3170R-4-0.30	■	■	■	■	■
0.40	1.60	3.00	39	3170R-4-0.40	■	■	■	■	■
0.50	2.00	3.00	39	3170R-4-0.50	■	■	■	■	■
0.60	2.40	3.00	39	3170R-4-0.60	■	■	■	■	■
0.70	2.80	3.00	39	3170R-4-0.70	■	■	■	■	■
0.80	3.20	3.00	39	3170R-4-0.80	■	■	■	■	■
0.90	3.60	3.00	39	3170R-4-0.90	■	■	■	■	■
1.00	4.00	3.00	39	3170R-4-1.00	■	■	■	■	■
1.10	4.40	3.00	39	3170R-4-1.10	■	■	■	■	■
1.20	4.80	3.00	39	3170R-4-1.20	■	■	■	■	■
1.30	5.20	3.00	39	3170R-4-1.30	■	■	■	■	■
1.40	5.60	3.00	39	3170R-4-1.40	■	■	■	■	■
1.50	6.00	3.00	39	3170R-4-1.50	■	■	■	■	■
2.00	8.00	3.00	39	3170R-4-2.00	■	■	■	■	■
2.50	10.00	3.00	39	3170R-4-2.50	■	■	■	■	■
3.00	12.00	4.00	40	3170R-4-3.00	■	■	■	■	■

Micro-fraises de précision

Mikropräzisionsfräser

Precision micro end mills

3271-0.75

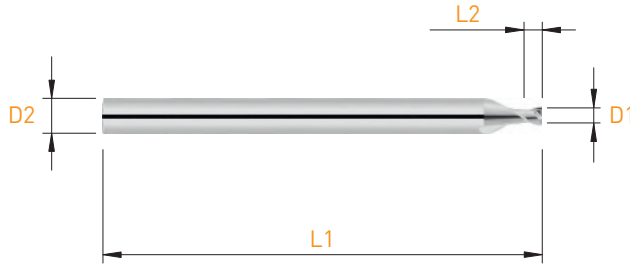

D1 +0.005 / -0.010	L2	D2 h4	L1	Art. N°	Z	TiAlN	STF	TiCN	DLC
0.20	0.15	3.00	39	3271-0.75-0.20	■				
0.30	0.25	3.00	39	3271-0.75-0.30	■	■	■	■	■
0.40	0.30	3.00	39	3271-0.75-0.40	■	■	■	■	■
0.50	0.37	3.00	39	3271-0.75-0.50	■	■	■	■	■
0.60	0.45	3.00	39	3271-0.75-0.60	■	■	■	■	■
0.70	0.53	3.00	39	3271-0.75-0.70	■	■	■	■	■
0.80	0.60	3.00	39	3271-0.75-0.80	■	■	■	■	■
0.90	0.70	3.00	39	3271-0.75-0.90	■	■	■	■	■
1.00	0.75	3.00	39	3271-0.75-1.00	■	■	■	■	■
1.10	0.90	3.00	39	3271-0.75-1.10	■	■	■	■	■
1.20	0.90	3.00	39	3271-0.75-1.20	■	■	■	■	■
1.30	1.00	3.00	39	3271-0.75-1.30	■	■	■	■	■
1.40	1.10	3.00	39	3271-0.75-1.40	■	■	■	■	■
1.50	1.15	3.00	39	3271-0.75-1.50	■	■	■	■	■
1.60	1.20	3.00	39	3271-0.75-1.60	■	■	■	■	■
1.70	1.30	3.00	39	3271-0.75-1.70	■	■	■	■	■
1.80	1.40	3.00	39	3271-0.75-1.80	■	■	■	■	■
1.90	1.45	3.00	39	3271-0.75-1.90	■	■	■	■	■
2.00	1.50	3.00	39	3271-0.75-2.00	■	■	■	■	■

MICRO-LINE

Micro-fraises de précision

Mikropräzisionsfräser

Precision micro end mills

3271-1

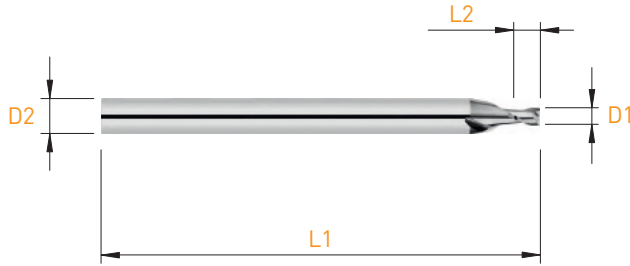

D1 +0.005 / -0.010	L2	D2 h4	L1	Art. N°	Z	TiAlN	STF	TiCN	DLC
0.30	0.30	3.00	39	3271-1-0.30	■	■	■	■	■
0.40	0.40	3.00	39	3271-1-0.40	■	■	■	■	■
0.50	0.50	3.00	39	3271-1-0.50	■	■	■	■	■
0.60	0.60	3.00	39	3271-1-0.60	■	■	■	■	■
0.70	0.70	3.00	39	3271-1-0.70	■	■	■	■	■
0.80	0.80	3.00	39	3271-1-0.80	■	■	■	■	■
0.90	0.90	3.00	39	3271-1-0.90	■	■	■	■	■
1.00	1.00	3.00	39	3271-1-1.00	■	■	■	■	■
1.10	1.10	3.00	39	3271-1-1.10	■	■	■	■	■
1.20	1.20	3.00	39	3271-1-1.20	■	■	■	■	■
1.30	1.30	3.00	39	3271-1-1.30	■	■	■	■	■
1.40	1.40	3.00	39	3271-1-1.40	■	■	■	■	■
1.50	1.50	3.00	39	3271-1-1.50	■	■	■	■	■
1.60	1.60	3.00	39	3271-1-1.60	■	■	■	■	■
1.70	1.70	3.00	39	3271-1-1.70	■	■	■	■	■
1.80	1.80	3.00	39	3271-1-1.80	■	■	■	■	■
1.90	1.90	3.00	39	3271-1-1.90	■	■	■	■	■
2.00	2.00	3.00	39	3271-1-2.00	■	■	■	■	■
2.50	2.50	3.00	39	3271-1-2.50	■	■	■	■	■

Micro-fraises de précision

Mikropräzisionsfräser

Precision micro end mills

3271-1.5

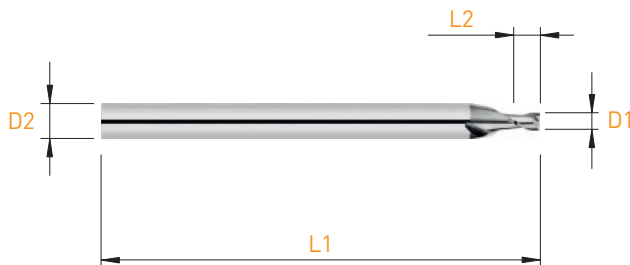

D1 +0.005 / -0.010	L2	D2 h4	L1	Art. N°	Z	TiAlN	STF	TiCN	DLC
0.10	0.15	3.00	39	3271-1.5-0.10	■				
0.15	0.20	3.00	39	3271-1.5-0.15	■				
0.20	0.30	3.00	39	3271-1.5-0.20	■				
0.25	0.35	3.00	39	3271-1.5-0.25	■				
0.30	0.45	3.00	39	3271-1.5-0.30	■	■	■	■	■
0.40	0.60	3.00	39	3271-1.5-0.40	■	■	■	■	■
0.45	0.70	3.00	39	3271-1.5-0.45	■	■	■	■	■
0.50	0.75	3.00	39	3271-1.5-0.50	■	■	■	■	■
0.60	0.90	3.00	39	3271-1.5-0.60	■	■	■	■	■
0.70	1.05	3.00	39	3271-1.5-0.70	■	■	■	■	■
0.80	1.20	3.00	39	3271-1.5-0.80	■	■	■	■	■
0.90	1.35	3.00	39	3271-1.5-0.90	■	■	■	■	■
1.00	1.50	3.00	39	3271-1.5-1.00	■	■	■	■	■
1.10	1.65	3.00	39	3271-1.5-1.10	■	■	■	■	■
1.20	1.80	3.00	39	3271-1.5-1.20	■	■	■	■	■
1.30	1.95	3.00	39	3271-1.5-1.30	■	■	■	■	■
1.40	2.10	3.00	39	3271-1.5-1.40	■	■	■	■	■
1.50	2.25	3.00	39	3271-1.5-1.50	■	■	■	■	■
1.60	2.40	3.00	39	3271-1.5-1.60	■	■	■	■	■
1.70	2.55	3.00	39	3271-1.5-1.70	■	■	■	■	■
1.80	2.70	3.00	39	3271-1.5-1.80	■	■	■	■	■
1.90	2.85	3.00	39	3271-1.5-1.90	■	■	■	■	■
2.00	3.00	3.00	39	3271-1.5-2.00	■	■	■	■	■

MICRO-LINE

Micro-fraises de précision

Mikropräzisionsfräser

Precision micro end mills

3271-2

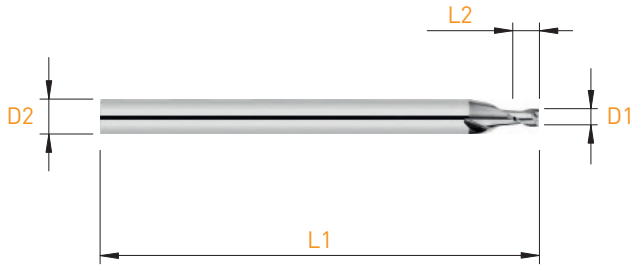

D1 +0.005 / -0.010	L2	D2 h4	L1	Art. N°	Z	TiAlN	STF	TiCN	DLC
0.10	0.20	3.00	39	3271-2-0.10	■				
0.15	0.30	3.00	39	3271-2-0.15	■				
0.20	0.40	3.00	39	3271-2-0.20	■				
0.25	0.50	3.00	39	3271-2-0.25	■				
0.30	0.60	3.00	39	3271-2-0.30	■	■	■	■	■
0.40	0.80	3.00	39	3271-2-0.40	■	■	■	■	■
0.50	1.00	3.00	39	3271-2-0.50	■	■	■	■	■
0.60	1.20	3.00	39	3271-2-0.60	■	■	■	■	■
0.70	1.40	3.00	39	3271-2-0.70	■	■	■	■	■
0.80	1.60	3.00	39	3271-2-0.80	■	■	■	■	■
0.90	1.80	3.00	39	3271-2-0.90	■	■	■	■	■
1.00	2.00	3.00	39	3271-2-1.00	■	■	■	■	■
1.10	2.20	3.00	39	3271-2-1.10	■	■	■	■	■
1.20	2.40	3.00	39	3271-2-1.20	■	■	■	■	■
1.30	2.60	3.00	39	3271-2-1.30	■	■	■	■	■
1.40	2.80	3.00	39	3271-2-1.40	■	■	■	■	■
1.50	3.00	3.00	39	3271-2-1.50	■	■	■	■	■
1.60	3.20	3.00	39	3271-2-1.60	■	■	■	■	■
1.70	3.40	3.00	39	3271-2-1.70	■	■	■	■	■
1.80	3.60	3.00	39	3271-2-1.80	■	■	■	■	■
1.90	3.80	3.00	39	3271-2-1.90	■	■	■	■	■
2.00	4.00	3.00	39	3271-2-2.00	■	■	■	■	■

Micro-fraises de précision

Mikropräzisionsfräser

Precision micro end mills

3271-3

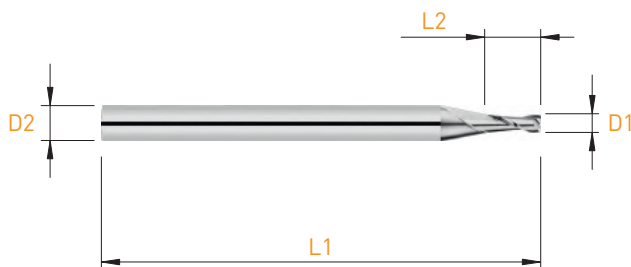

MD VHM HM λ 30° Sharp Corner 3xD1 Z=2

D1 +0.005 / -0.010	L2	D2 h4	L1	Art. N°	Z	TiAIN	STF	TiCN	DLC
0.10	0.25	3.00	39	3271-3-0.10	■				
0.15	0.45	3.00	39	3271-3-0.15	■				
0.20	0.50	3.00	39	3271-3-0.20	■				
0.25	0.75	3.00	39	3271-3-0.25	■				
0.30	1.00	3.00	39	3271-3-0.30	■	■	■	■	■
0.35	1.10	3.00	39	3271-3-0.35	■	■	■	■	■
0.40	1.20	3.00	39	3271-3-0.40	■	■	■	■	■
0.50	1.50	3.00	39	3271-3-0.50	■	■	■	■	■
0.60	2.00	3.00	39	3271-3-0.60	■	■	■	■	■
0.65	2.00	3.00	39	3271-3-0.65	■	■	■	■	■
0.70	2.00	3.00	39	3271-3-0.70	■	■	■	■	■
0.75	2.00	3.00	39	3271-3-0.75	■	■	■	■	■
0.80	2.50	3.00	39	3271-3-0.80	■	■	■	■	■
0.90	2.50	3.00	39	3271-3-0.90	■	■	■	■	■
0.95	3.00	3.00	39	3271-3-0.95	■	■	■	■	■
1.00	3.00	3.00	39	3271-3-1.00	■	■	■	■	■
1.05	3.00	3.00	39	3271-3-1.05	■	■	■	■	■
1.10	3.00	3.00	39	3271-3-1.10	■	■	■	■	■
1.15	3.50	3.00	39	3271-3-1.15	■	■	■	■	■
1.20	4.00	3.00	39	3271-3-1.20	■	■	■	■	■
1.30	4.00	3.00	39	3271-3-1.30	■	■	■	■	■
1.35	4.00	3.00	39	3271-3-1.35	■	■	■	■	■
1.40	4.00	3.00	39	3271-3-1.40	■	■	■	■	■
1.45	4.40	3.00	39	3271-3-1.45	■	■	■	■	■
1.50	4.50	3.00	39	3271-3-1.50	■	■	■	■	■
1.55	4.50	3.00	39	3271-3-1.55	■	■	■	■	■
1.60	4.50	3.00	39	3271-3-1.60	■	■	■	■	■
1.65	5.00	3.00	39	3271-3-1.65	■	■	■	■	■
1.70	5.00	3.00	39	3271-3-1.70	■	■	■	■	■
1.75	5.30	3.00	39	3271-3-1.75	■	■	■	■	■

D1 +0.005 / -0.010	L2	D2 h4	L1	Art. N°	Z	TiAIN	STF	TiCN	DLC
1.80	6.00	3.00	39	3271-3-1.80	■	■	■	■	■
1.85	6.00	3.00	39	3271-3-1.85	■	■	■	■	■
1.90	6.00	3.00	39	3271-3-1.90	■	■	■	■	■
1.95	6.00	3.00	39	3271-3-1.95	■	■	■	■	■
2.00	6.00	3.00	39	3271-3-2.00	■	■	■	■	■
2.10	6.00	3.00	39	3271-3-2.10	■	■	■	■	■
2.20	6.50	3.00	39	3271-3-2.20	■	■	■	■	■
2.30	7.00	3.00	39	3271-3-2.30	■	■	■	■	■
2.40	7.00	3.00	39	3271-3-2.40	■	■	■	■	■
2.50	7.50	3.00	39	3271-3-2.50	■	■	■	■	■
2.60	7.50	3.00	39	3271-3-2.60	■	■	■	■	■
2.70	8.00	3.00	39	3271-3-2.70	■	■	■	■	■
2.80	8.00	3.00	39	3271-3-2.80	■	■	■	■	■
2.90	8.00	3.00	39	3271-3-2.90	■	■	■	■	■

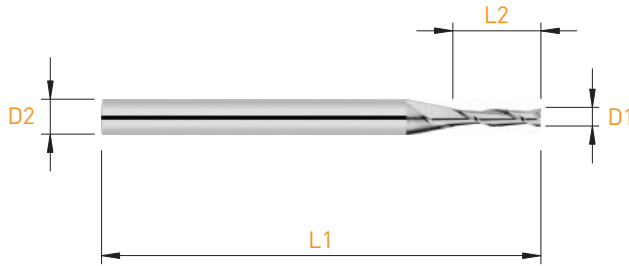

D1 +0.005 / -0.010	L2	D2 h4	L1	Art. N°	Z	TiAlN	STF	TiCN	DLC
0.30	1.50	3.00	39	3271-5-0.30	■	■	■	■	■
0.35	1.80	3.00	39	3271-5-0.35	■	■	■	■	■
0.40	2.00	3.00	39	3271-5-0.40	■	■	■	■	■
0.50	2.50	3.00	39	3271-5-0.50	■	■	■	■	■
0.55	2.80	3.00	39	3271-5-0.55	■	■	■	■	■
0.60	3.00	3.00	39	3271-5-0.60	■	■	■	■	■
0.65	3.30	3.00	39	3271-5-0.65	■	■	■	■	■
0.70	3.50	3.00	39	3271-5-0.70	■	■	■	■	■
0.75	3.80	3.00	39	3271-5-0.75	■	■	■	■	■
0.80	4.00	3.00	39	3271-5-0.80	■	■	■	■	■
0.85	4.30	3.00	39	3271-5-0.85	■	■	■	■	■
0.90	4.50	3.00	39	3271-5-0.90	■	■	■	■	■
0.95	4.80	3.00	39	3271-5-0.95	■	■	■	■	■
1.00	5.00	3.00	39	3271-5-1.00	■	■	■	■	■
1.10	5.50	3.00	39	3271-5-1.10	■	■	■	■	■
1.20	6.00	3.00	39	3271-5-1.20	■	■	■	■	■
1.50	7.50	3.00	39	3271-5-1.50	■	■	■	■	■
2.00	10.00	3.00	39	3271-5-2.00	■	■	■	■	■
2.50	12.50	3.00	39	3271-5-2.50	■	■	■	■	■

Micro-fraises de précision

Mikropräzisionsfräser

Precision micro end mills

3271-8

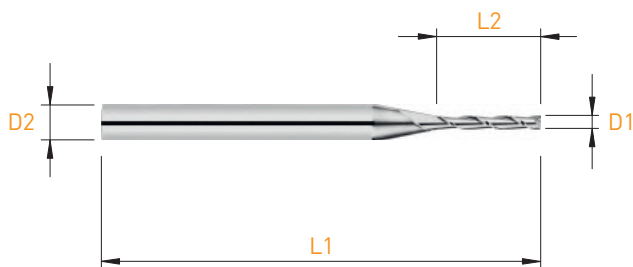

D1 +0.005 / -0.010	L2	D2 h4 03.0 h5 04.0	L1	Art. N°	Z	TiAlN	STF	TiCN	DLC
0.40	3.20	3.00	39	3271-8-0.40	■	■	■	■	■
0.50	4.00	3.00	39	3271-8-0.50	■	■	■	■	■
0.60	5.00	3.00	39	3271-8-0.60	■	■	■	■	■
0.70	5.60	3.00	39	3271-8-0.70	■	■	■	■	■
0.80	6.00	3.00	39	3271-8-0.80	■	■	■	■	■
0.90	7.20	3.00	39	3271-8-0.90	■	■	■	■	■
1.00	8.00	3.00	39	3271-8-1.00	■	■	■	■	■
1.20	9.00	3.00	39	3271-8-1.20	■	■	■	■	■
1.50	12.00	4.00	50	3271-8-1.50	■	■	■	■	■
2.00	16.00	4.00	50	3271-8-2.00	■	■	■	■	■
2.50	20.00	4.00	50	3271-8-2.50	■	■	■	■	■

MICRO-LINE

Micro-fraises de précision

Mikropräzisionsfräser

Precision micro end mills

3270S-3X

new

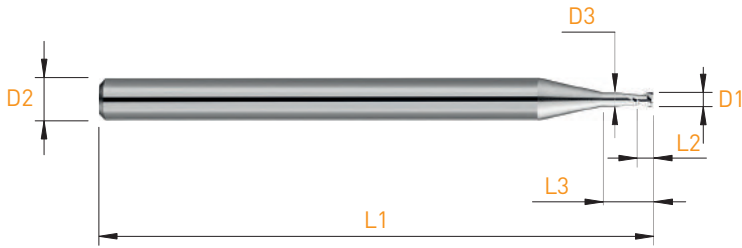

D1 +0.005 / -0.010	L2	L3	D3	D2 h4 Ø3.0 h5 Ø6.0	L1	Art. N°	Z	TiAIN	STF	TiCN	DLC
0.20	0.40	0.60	0.17	3.00	39	3270S-3X-0.20	■				
0.30	0.60	0.90	0.27	3.00	39	3270S-3X-0.30	■	■	■	■	■
0.40	0.80	1.20	0.37	3.00	39	3270S-3X-0.40	■	■	■	■	■
0.50	1.00	1.50	0.45	3.00	39	3270S-3X-0.50	■	■	■	■	■
0.60	1.20	1.80	0.55	3.00	39	3270S-3X-0.60	■	■	■	■	■
0.70	1.40	2.10	0.65	3.00	39	3270S-3X-0.70	■	■	■	■	■
0.80	1.60	2.40	0.75	3.00	39	3270S-3X-0.80	■	■	■	■	■
0.90	1.80	2.70	0.85	3.00	39	3270S-3X-0.90	■	■	■	■	■
1.00	2.00	3.00	0.95	3.00	39	3270S-3X-1.00	■	■	■	■	■
1.10	2.20	3.30	1.05	3.00	39	3270S-3X-1.10	■	■	■	■	■
1.20	2.40	3.60	1.15	3.00	39	3270S-3X-1.20	■	■	■	■	■
1.30	2.60	3.90	1.25	3.00	39	3270S-3X-1.30	■	■	■	■	■
1.40	2.80	4.20	1.35	3.00	39	3270S-3X-1.40	■	■	■	■	■
1.50	3.00	4.50	1.45	3.00	39	3270S-3X-1.50	■	■	■	■	■
1.60	3.20	4.80	1.55	3.00	39	3270S-3X-1.60	■	■	■	■	■
1.70	3.40	5.10	1.65	3.00	39	3270S-3X-1.70	■	■	■	■	■
1.80	3.60	5.40	1.75	3.00	39	3270S-3X-1.80	■	■	■	■	■
1.90	3.80	5.70	1.85	3.00	39	3270S-3X-1.90	■	■	■	■	■
2.00	4.00	6.00	1.95	6.00	50	3270S-3X-2.00	■	■	■	■	■
2.10	4.20	6.30	2.05	6.00	50	3270S-3X-2.10	■	■	■	■	■
2.20	4.40	6.60	2.15	6.00	50	3270S-3X-2.20	■	■	■	■	■
2.30	4.60	6.90	2.25	6.00	50	3270S-3X-2.30	■	■	■	■	■
2.40	4.80	7.20	2.35	6.00	50	3270S-3X-2.40	■	■	■	■	■
2.50	5.00	7.50	2.45	6.00	50	3270S-3X-2.50	■	■	■	■	■
3.00	6.00	9.00	2.95	6.00	50	3270S-3X-3.00	■	■	■	■	■

Micro-fraises de précision

Mikropräzisionsfräser

Precision micro end mills

3270S-6X

new



MD VHM HM $\lambda 30^\circ$ Sharp Corner  L3 6xD1 Z=2 

D1 +0.005 / -0.010	L2	L3	D3	D2 h4 Ø3.0 h5 Ø6.0	L1	Art. N°	Z	TiAIN	STF	TiCN	DLC
0.30	0.60	1.80	0.27	3.00	39	3270S-6X-0.30	■	■	■	■	■
0.40	0.80	2.40	0.37	3.00	39	3270S-6X-0.40	■	■	■	■	■
0.50	1.00	3.00	0.45	3.00	39	3270S-6X-0.50	■	■	■	■	■
0.60	1.20	3.60	0.55	3.00	39	3270S-6X-0.60	■	■	■	■	■
0.70	1.40	4.20	0.65	3.00	39	3270S-6X-0.70	■	■	■	■	■
0.80	1.60	4.80	0.75	3.00	39	3270S-6X-0.80	■	■	■	■	■
0.90	1.80	5.40	0.85	3.00	39	3270S-6X-0.90	■	■	■	■	■
1.00	2.00	6.00	0.95	3.00	39	3270S-6X-1.00	■	■	■	■	■
1.10	2.20	6.60	1.05	3.00	39	3270S-6X-1.10	■	■	■	■	■
1.20	2.40	7.20	1.15	3.00	39	3270S-6X-1.20	■	■	■	■	■
1.30	2.60	7.80	1.25	3.00	39	3270S-6X-1.30	■	■	■	■	■
1.40	2.80	8.40	1.35	3.00	39	3270S-6X-1.40	■	■	■	■	■
1.50	3.00	9.00	1.45	3.00	39	3270S-6X-1.50	■	■	■	■	■
1.60	3.20	9.60	1.55	3.00	39	3270S-6X-1.60	■	■	■	■	■
1.70	3.40	10.20	1.65	3.00	39	3270S-6X-1.70	■	■	■	■	■
1.80	3.60	10.80	1.75	3.00	39	3270S-6X-1.80	■	■	■	■	■
1.90	3.80	11.40	1.85	3.00	39	3270S-6X-1.90	■	■	■	■	■
2.00	4.00	12.00	1.95	6.00	50	3270S-6X-2.00	■	■	■	■	■
2.10	4.20	12.60	2.05	6.00	50	3270S-6X-2.10	■	■	■	■	■
2.20	4.40	13.20	2.15	6.00	50	3270S-6X-2.20	■	■	■	■	■
2.30	4.60	13.80	2.25	6.00	50	3270S-6X-2.30	■	■	■	■	■
2.40	4.80	14.40	2.35	6.00	50	3270S-6X-2.40	■	■	■	■	■
2.50	5.00	15.00	2.45	6.00	50	3270S-6X-2.50	■	■	■	■	■
3.00	6.00	18.00	2.95	6.00	50	3270S-6X-3.00	■	■	■	■	■

MICRO-LINE

Micro-fraises de précision

Mikropräzisionsfräser

Precision micro end mills

3270S-9X

new

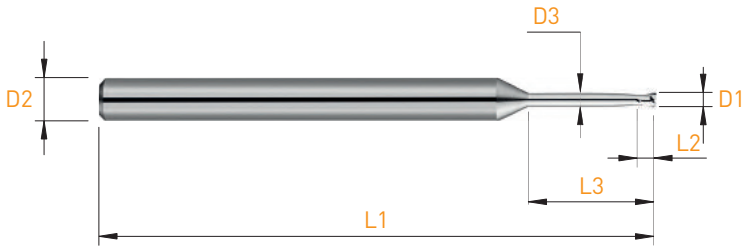

D1 +0.005 / -0.010	L2	L3	D3	D2 h4 $\varnothing 3.0$ h5 $\varnothing 6.0$	L1	Art. N°	Z	TiAIN	STF	TiCN	DLC
0.40	0.80	3.60	0.37	3.00	39	3270S-9X-0.40	■	■	■	■	■
0.50	1.00	4.50	0.45	3.00	39	3270S-9X-0.50	■	■	■	■	■
0.60	1.20	5.40	0.55	3.00	39	3270S-9X-0.60	■	■	■	■	■
0.70	1.40	6.30	0.65	3.00	39	3270S-9X-0.70	■	■	■	■	■
0.80	1.60	7.20	0.75	3.00	39	3270S-9X-0.80	■	■	■	■	■
0.90	1.80	8.10	0.85	3.00	39	3270S-9X-0.90	■	■	■	■	■
1.00	2.00	9.00	0.95	3.00	39	3270S-9X-1.00	■	■	■	■	■
1.10	2.20	9.90	1.05	3.00	39	3270S-9X-1.10	■	■	■	■	■
1.20	2.40	10.80	1.15	3.00	39	3270S-9X-1.20	■	■	■	■	■
1.30	2.60	11.70	1.25	3.00	39	3270S-9X-1.30	■	■	■	■	■
1.40	2.80	12.60	1.35	3.00	39	3270S-9X-1.40	■	■	■	■	■
1.50	3.00	13.50	1.45	3.00	39	3270S-9X-1.50	■	■	■	■	■
1.60	3.20	14.40	1.55	3.00	39	3270S-9X-1.60	■	■	■	■	■
1.70	3.40	15.30	1.65	3.00	39	3270S-9X-1.70	■	■	■	■	■
1.80	3.60	16.20	1.75	3.00	39	3270S-9X-1.80	■	■	■	■	■
1.90	3.80	17.10	1.85	3.00	39	3270S-9X-1.90	■	■	■	■	■
2.00	4.00	18.00	1.95	6.00	50	3270S-9X-2.00	■	■	■	■	■
2.10	4.20	18.90	2.05	6.00	50	3270S-9X-2.10	■	■	■	■	■
2.20	4.40	19.80	2.15	6.00	50	3270S-9X-2.20	■	■	■	■	■
2.30	4.60	20.70	2.25	6.00	50	3270S-9X-2.30	■	■	■	■	■
2.40	4.80	21.60	2.35	6.00	50	3270S-9X-2.40	■	■	■	■	■
2.50	5.00	22.50	2.45	6.00	50	3270S-9X-2.50	■	■	■	■	■
3.00	6.00	27.00	2.95	6.00	50	3270S-9X-3.00	■	■	■	■	■

Micro-fraises de précision

Mikropräzisionsfräser

Precision micro end mills

3279T-3X

new

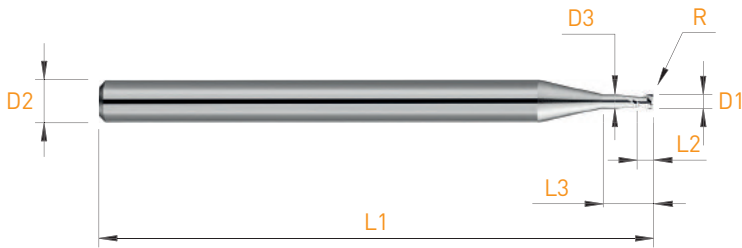

D1 +0.005 / -0.010	R +/- 0.02	L2	L3	D3	D2 h4 Ø3.0 h5 Ø6.0	L1	Art. N°	Z	TiAlN	STF	TiCN	DLC
0.30	0.05	0.60	0.90	0.27	3.00	39	3279T-3X-0.30	■	■	■	■	■
0.40	0.05	0.80	1.20	0.37	3.00	39	3279T-3X-0.40	■	■	■	■	■
0.50	0.05	1.00	1.50	0.45	3.00	39	3279T-3X-0.50	■	■	■	■	■
0.60	0.05	1.20	1.80	0.55	3.00	39	3279T-3X-0.60	■	■	■	■	■
0.70	0.05	1.40	2.10	0.65	3.00	39	3279T-3X-0.70	■	■	■	■	■
0.80	0.05	1.60	2.40	0.75	3.00	39	3279T-3X-0.80	■	■	■	■	■
0.90	0.05	1.80	2.70	0.85	3.00	39	3279T-3X-0.90	■	■	■	■	■
1.00	0.10	2.00	3.00	0.95	3.00	39	3279T-3X-1.00	■	■	■	■	■
1.10	0.10	2.20	3.30	1.05	3.00	39	3279T-3X-1.10	■	■	■	■	■
1.20	0.10	2.40	3.60	1.15	3.00	39	3279T-3X-1.20	■	■	■	■	■
1.30	0.10	2.60	3.90	1.25	3.00	39	3279T-3X-1.30	■	■	■	■	■
1.40	0.10	2.80	4.20	1.35	3.00	39	3279T-3X-1.40	■	■	■	■	■
1.50	0.20	3.00	4.50	1.45	3.00	39	3279T-3X-1.50	■	■	■	■	■
1.60	0.20	3.20	4.80	1.55	3.00	39	3279T-3X-1.60	■	■	■	■	■
1.70	0.20	3.40	5.10	1.65	3.00	39	3279T-3X-1.70	■	■	■	■	■
1.80	0.20	3.60	5.40	1.75	3.00	39	3279T-3X-1.80	■	■	■	■	■
1.90	0.20	3.80	5.70	1.85	3.00	39	3279T-3X-1.90	■	■	■	■	■
2.00	0.20	4.00	6.00	1.95	6.00	50	3279T-3X-2.00	■	■	■	■	■
2.10	0.20	4.20	6.30	2.05	6.00	50	3279T-3X-2.10	■	■	■	■	■
2.20	0.20	4.40	6.60	2.15	6.00	50	3279T-3X-2.20	■	■	■	■	■
2.30	0.20	4.60	6.90	2.25	6.00	50	3279T-3X-2.30	■	■	■	■	■
2.40	0.20	4.80	7.20	2.35	6.00	50	3279T-3X-2.40	■	■	■	■	■
2.50	0.20	5.00	7.50	2.45	6.00	50	3279T-3X-2.50	■	■	■	■	■
3.00	0.20	6.00	9.00	2.95	6.00	50	3279T-3X-3.00	■	■	■	■	■

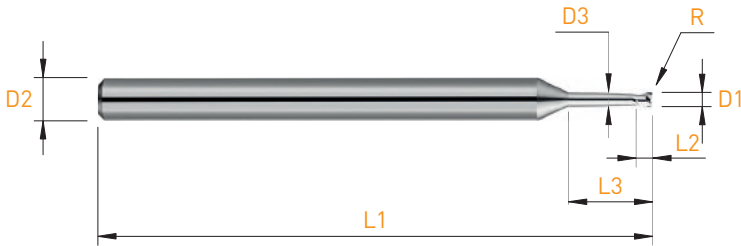

D1 +0.005 / -0.010	R +/- 0.02	L2	L3	D3	D2 h4 Ø3.0 h5 Ø6.0	L1	Art. N°	Z	TiAlN	STF	TiCN	DLC
0.30	0.05	0.60	1.80	0.27	3.00	39	3279T-6X-0.30	■	■	■	■	■
0.40	0.05	0.80	2.40	0.37	3.00	39	3279T-6X-0.40	■	■	■	■	■
0.50	0.05	1.00	3.00	0.45	3.00	39	3279T-6X-0.50	■	■	■	■	■
0.60	0.05	1.20	3.60	0.55	3.00	39	3279T-6X-0.60	■	■	■	■	■
0.70	0.05	1.40	4.20	0.65	3.00	39	3279T-6X-0.70	■	■	■	■	■
0.80	0.05	1.60	4.80	0.75	3.00	39	3279T-6X-0.80	■	■	■	■	■
0.90	0.05	1.80	5.40	0.85	3.00	39	3279T-6X-0.90	■	■	■	■	■
1.00	0.10	2.00	6.00	0.95	3.00	39	3279T-6X-1.00	■	■	■	■	■
1.10	0.10	2.20	6.60	1.05	3.00	39	3279T-6X-1.10	■	■	■	■	■
1.20	0.10	2.40	7.20	1.15	3.00	39	3279T-6X-1.20	■	■	■	■	■
1.30	0.10	2.60	7.80	1.25	3.00	39	3279T-6X-1.30	■	■	■	■	■
1.40	0.10	2.80	8.40	1.35	3.00	39	3279T-6X-1.40	■	■	■	■	■
1.50	0.20	3.00	9.00	1.45	3.00	39	3279T-6X-1.50	■	■	■	■	■
1.60	0.20	3.20	9.60	1.55	3.00	39	3279T-6X-1.60	■	■	■	■	■
1.70	0.20	3.40	10.20	1.65	3.00	39	3279T-6X-1.70	■	■	■	■	■
1.80	0.20	3.60	10.80	1.75	3.00	39	3279T-6X-1.80	■	■	■	■	■
1.90	0.20	3.80	11.40	1.85	3.00	39	3279T-6X-1.90	■	■	■	■	■
2.00	0.20	4.00	12.00	1.95	6.00	50	3279T-6X-2.00	■	■	■	■	■
2.10	0.20	4.20	12.60	2.05	6.00	50	3279T-6X-2.10	■	■	■	■	■
2.20	0.20	4.40	13.20	2.15	6.00	50	3279T-6X-2.20	■	■	■	■	■
2.30	0.20	4.60	13.80	2.25	6.00	50	3279T-6X-2.30	■	■	■	■	■
2.40	0.20	4.80	14.40	2.35	6.00	50	3279T-6X-2.40	■	■	■	■	■
2.50	0.20	5.00	15.00	2.45	6.00	50	3279T-6X-2.50	■	■	■	■	■
3.00	0.20	6.00	18.00	2.95	6.00	50	3279T-6X-3.00	■	■	■	■	■

Micro-fraises de précision

Mikropräzisionsfräser

Precision micro end mills

3279T-9X

new

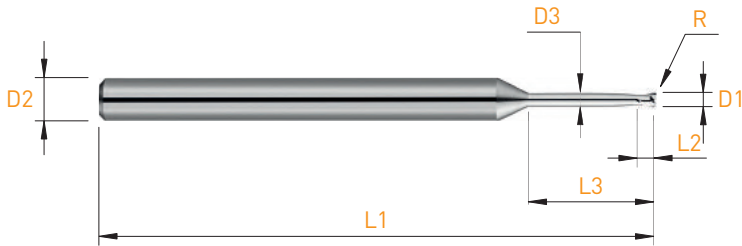

D1 +0.005 / -0.010	R +/- 0.02	L2	L3	D3	D2 h4 Ø3.0 h5 Ø6.0	L1	Art. N°	Z	TiAlN	STF	TiCN	DLC
0.40	0.05	0.80	3.60	0.37	3.00	39	3279T-9X-0.40	■	■	■	■	■
0.50	0.05	1.00	4.50	0.45	3.00	39	3279T-9X-0.50	■	■	■	■	■
0.60	0.05	1.20	5.40	0.55	3.00	39	3279T-9X-0.60	■	■	■	■	■
0.70	0.05	1.40	6.30	0.65	3.00	39	3279T-9X-0.70	■	■	■	■	■
0.80	0.05	1.60	7.20	0.75	3.00	39	3279T-9X-0.80	■	■	■	■	■
0.90	0.05	1.80	8.10	0.85	3.00	39	3279T-9X-0.90	■	■	■	■	■
1.00	0.10	2.00	9.00	0.95	3.00	39	3279T-9X-1.00	■	■	■	■	■
1.10	0.10	2.20	9.90	1.05	3.00	39	3279T-9X-1.10	■	■	■	■	■
1.20	0.10	2.40	10.80	1.15	3.00	39	3279T-9X-1.20	■	■	■	■	■
1.30	0.10	2.60	11.70	1.25	3.00	39	3279T-9X-1.30	■	■	■	■	■
1.40	0.10	2.80	12.60	1.35	3.00	39	3279T-9X-1.40	■	■	■	■	■
1.50	0.20	3.00	13.50	1.45	3.00	39	3279T-9X-1.50	■	■	■	■	■
1.60	0.20	3.20	14.40	1.55	3.00	39	3279T-9X-1.60	■	■	■	■	■
1.70	0.20	3.40	15.30	1.65	3.00	39	3279T-9X-1.70	■	■	■	■	■
1.80	0.20	3.60	16.20	1.75	3.00	39	3279T-9X-1.80	■	■	■	■	■
1.90	0.20	3.80	17.10	1.85	3.00	39	3279T-9X-1.90	■	■	■	■	■
2.00	0.20	4.00	18.00	1.95	6.00	50	3279T-9X-2.00	■	■	■	■	■
2.10	0.20	4.20	18.90	2.05	6.00	50	3279T-9X-2.10	■	■	■	■	■
2.20	0.20	4.40	19.80	2.15	6.00	50	3279T-9X-2.20	■	■	■	■	■
2.30	0.20	4.60	20.70	2.25	6.00	50	3279T-9X-2.30	■	■	■	■	■
2.40	0.20	4.80	21.60	2.35	6.00	50	3279T-9X-2.40	■	■	■	■	■
2.50	0.20	5.00	22.50	2.45	6.00	50	3279T-9X-2.50	■	■	■	■	■
3.00	0.20	6.00	27.00	2.95	6.00	50	3279T-9X-3.00	■	■	■	■	■

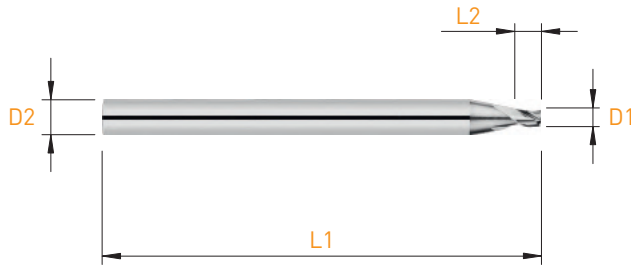

D1 +0.005 / -0.010	L2	D2 h4	L1	Art. N°	Z	TiAlN	STF	TiCN	DLC
0.30	0.40	3.00	39	3371-1.3-0.30	■	■	■	■	■
0.35	0.50	3.00	39	3371-1.3-0.35	■	■	■	■	■
0.40	0.50	3.00	39	3371-1.3-0.40	■	■	■	■	■
0.45	0.60	3.00	39	3371-1.3-0.45	■	■	■	■	■
0.50	0.70	3.00	39	3371-1.3-0.50	■	■	■	■	■
0.60	0.80	3.00	39	3371-1.3-0.60	■	■	■	■	■
0.70	0.90	3.00	39	3371-1.3-0.70	■	■	■	■	■
0.80	1.00	3.00	39	3371-1.3-0.80	■	■	■	■	■
0.90	1.30	3.00	39	3371-1.3-0.90	■	■	■	■	■
1.00	1.30	3.00	39	3371-1.3-1.00	■	■	■	■	■
1.10	1.50	3.00	39	3371-1.3-1.10	■	■	■	■	■
1.20	1.60	3.00	39	3371-1.3-1.20	■	■	■	■	■
1.30	1.80	3.00	39	3371-1.3-1.30	■	■	■	■	■
1.40	1.80	3.00	39	3371-1.3-1.40	■	■	■	■	■
1.50	2.00	3.00	39	3371-1.3-1.50	■	■	■	■	■
1.55	2.00	3.00	39	3371-1.3-1.55	■	■	■	■	■
1.60	2.00	3.00	39	3371-1.3-1.60	■	■	■	■	■
1.65	2.00	3.00	39	3371-1.3-1.65	■	■	■	■	■
1.70	2.00	3.00	39	3371-1.3-1.70	■	■	■	■	■
1.80	2.40	3.00	39	3371-1.3-1.80	■	■	■	■	■
1.90	2.40	3.00	39	3371-1.3-1.90	■	■	■	■	■
2.00	2.60	3.00	39	3371-1.3-2.00	■	■	■	■	■
2.05	2.70	3.00	39	3371-1.3-2.05	■	■	■	■	■
2.20	3.00	3.00	39	3371-1.3-2.20	■	■	■	■	■
2.50	3.30	3.00	39	3371-1.3-2.50	■	■	■	■	■
2.80	3.50	3.00	39	3371-1.3-2.80	■	■	■	■	■
2.90	3.50	3.00	39	3371-1.3-2.90	■	■	■	■	■

Micro-fraises de précision

Mikropräzisionsfräser

Precision micro end mills

3371-2

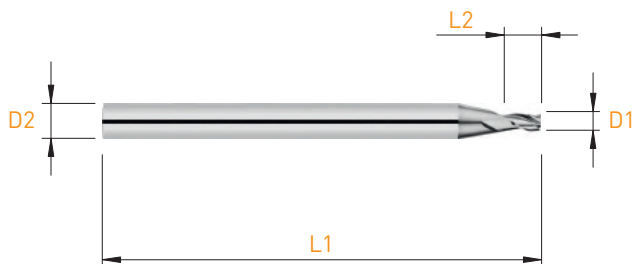

D1 +0.005 / -0.010	L2	D2 h4	L1	Art. N°	Z	TiAlN	STF	TiCN	DLC
0.30	0.60	3.00	39	3371-2-0.30	■	■	■	■	■
0.35	0.70	3.00	39	3371-2-0.35	■	■	■	■	■
0.40	0.80	3.00	39	3371-2-0.40	■	■	■	■	■
0.45	0.90	3.00	39	3371-2-0.45	■	■	■	■	■
0.50	1.00	3.00	39	3371-2-0.50	■	■	■	■	■
0.60	1.20	3.00	39	3371-2-0.60	■	■	■	■	■
0.70	1.40	3.00	39	3371-2-0.70	■	■	■	■	■
0.75	1.50	3.00	39	3371-2-0.75	■	■	■	■	■
0.80	1.60	3.00	39	3371-2-0.80	■	■	■	■	■
0.90	1.80	3.00	39	3371-2-0.90	■	■	■	■	■
0.95	1.90	3.00	39	3371-2-0.95	■	■	■	■	■
1.00	2.00	3.00	39	3371-2-1.00	■	■	■	■	■
1.10	2.20	3.00	39	3371-2-1.10	■	■	■	■	■
1.20	2.40	3.00	39	3371-2-1.20	■	■	■	■	■
1.30	2.60	3.00	39	3371-2-1.30	■	■	■	■	■
1.40	2.80	3.00	39	3371-2-1.40	■	■	■	■	■
1.50	3.00	3.00	39	3371-2-1.50	■	■	■	■	■
1.60	3.20	3.00	39	3371-2-1.60	■	■	■	■	■
1.70	3.40	3.00	39	3371-2-1.70	■	■	■	■	■
1.80	3.60	3.00	39	3371-2-1.80	■	■	■	■	■
1.90	3.80	3.00	39	3371-2-1.90	■	■	■	■	■
2.00	4.00	3.00	39	3371-2-2.00	■	■	■	■	■
2.10	4.20	3.00	39	3371-2-2.10	■	■	■	■	■
2.20	4.40	3.00	39	3371-2-2.20	■	■	■	■	■
2.30	4.60	3.00	39	3371-2-2.30	■	■	■	■	■
2.40	4.80	3.00	39	3371-2-2.40	■	■	■	■	■
2.50	5.00	3.00	39	3371-2-2.50	■	■	■	■	■
2.60	5.20	3.00	39	3371-2-2.60	■	■	■	■	■
2.70	5.40	3.00	39	3371-2-2.70	■	■	■	■	■
2.80	5.60	3.00	39	3371-2-2.80	■	■	■	■	■
2.90	5.80	3.00	39	3371-2-2.90	■	■	■	■	■

MICRO-LINE

Micro-fraises de précision

Mikropräzisionsfräser

Precision micro end mills

3371-3

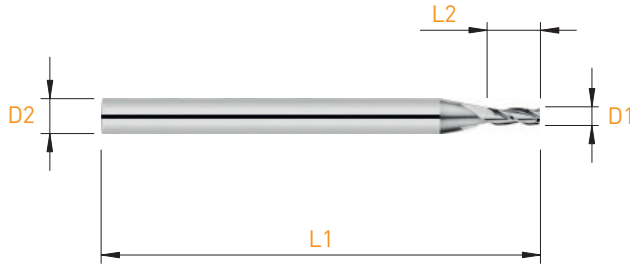

MD VHM HM λ 30° Sharp Corner  3xD1 Z=3 

D1 +0.005 / -0.010	L2	D2 h4	L1	Art. N°	Z	TiAIN	STF	TiCN	DLC
0.30	0.90	3.00	39	3371-3-0.30	■	■	■	■	■
0.40	1.20	3.00	39	3371-3-0.40	■	■	■	■	■
0.45	1.40	3.00	39	3371-3-0.45	■	■	■	■	■
0.50	1.50	3.00	39	3371-3-0.50	■	■	■	■	■
0.55	1.80	3.00	39	3371-3-0.55	■	■	■	■	■
0.60	2.00	3.00	39	3371-3-0.60	■	■	■	■	■
0.65	2.00	3.00	39	3371-3-0.65	■	■	■	■	■
0.70	2.00	3.00	39	3371-3-0.70	■	■	■	■	■
0.75	2.00	3.00	39	3371-3-0.75	■	■	■	■	■
0.80	2.50	3.00	39	3371-3-0.80	■	■	■	■	■
0.85	2.50	3.00	39	3371-3-0.85	■	■	■	■	■
0.90	2.50	3.00	39	3371-3-0.90	■	■	■	■	■
0.95	2.90	3.00	39	3371-3-0.95	■	■	■	■	■
1.00	3.00	3.00	39	3371-3-1.00	■	■	■	■	■
1.05	3.20	3.00	39	3371-3-1.05	■	■	■	■	■
1.10	3.30	3.00	39	3371-3-1.10	■	■	■	■	■
1.15	3.50	3.00	39	3371-3-1.15	■	■	■	■	■
1.20	4.00	3.00	39	3371-3-1.20	■	■	■	■	■
1.25	4.00	3.00	39	3371-3-1.25	■	■	■	■	■
1.30	4.00	3.00	39	3371-3-1.30	■	■	■	■	■
1.35	4.00	3.00	39	3371-3-1.35	■	■	■	■	■
1.40	4.00	3.00	39	3371-3-1.40	■	■	■	■	■
1.45	4.50	3.00	39	3371-3-1.45	■	■	■	■	■
1.50	4.50	3.00	39	3371-3-1.50	■	■	■	■	■
1.60	4.50	3.00	39	3371-3-1.60	■	■	■	■	■
1.65	5.00	3.00	39	3371-3-1.65	■	■	■	■	■
1.70	5.00	3.00	39	3371-3-1.70	■	■	■	■	■
1.80	6.00	3.00	39	3371-3-1.80	■	■	■	■	■
1.85	6.00	3.00	39	3371-3-1.85	■	■	■	■	■
1.90	6.00	3.00	39	3371-3-1.90	■	■	■	■	■
1.95	6.00	3.00	39	3371-3-1.95	■	■	■	■	■

D1 +0.005 / -0.010	L2	D2 h4	L1	Art. N°	Z	TiAIN	STF	TiCN	DLC
2.00	6.00	3.00	39	3371-3-2.00	■	■	■	■	■
2.10	6.00	3.00	39	3371-3-2.10	■	■	■	■	■
2.20	6.50	3.00	39	3371-3-2.20	■	■	■	■	■
2.30	7.00	3.00	39	3371-3-2.30	■	■	■	■	■
2.40	7.00	3.00	39	3371-3-2.40	■	■	■	■	■
2.50	7.50	3.00	39	3371-3-2.50	■	■	■	■	■
2.60	7.50	3.00	39	3371-3-2.60	■	■	■	■	■
2.70	8.00	3.00	39	3371-3-2.70	■	■	■	■	■
2.80	8.00	3.00	39	3371-3-2.80	■	■	■	■	■
2.90	8.50	3.00	39	3371-3-2.90	■	■	■	■	■

Micro-fraises de précision

Mikropräzisionsfräser

Precision micro end mills

3371-4

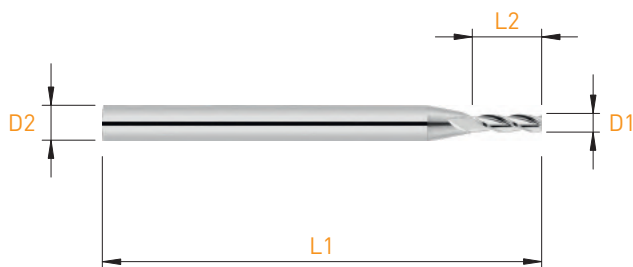

D1 +0.005 / -0.010	L2	D2 h4	L1	Art. N°	Z	TiAlN	STF	TiCN	DLC
0.30	1.20	3.00	39	3371-4-0.30	■	■	■	■	■
0.40	1.60	3.00	39	3371-4-0.40	■	■	■	■	■
0.50	2.00	3.00	39	3371-4-0.50	■	■	■	■	■
0.60	2.40	3.00	39	3371-4-0.60	■	■	■	■	■
0.70	2.80	3.00	39	3371-4-0.70	■	■	■	■	■
0.80	3.20	3.00	39	3371-4-0.80	■	■	■	■	■
0.90	3.60	3.00	39	3371-4-0.90	■	■	■	■	■
1.00	4.00	3.00	39	3371-4-1.00	■	■	■	■	■
1.10	4.40	3.00	39	3371-4-1.10	■	■	■	■	■
1.20	4.80	3.00	39	3371-4-1.20	■	■	■	■	■
1.30	5.20	3.00	39	3371-4-1.30	■	■	■	■	■
1.40	5.60	3.00	39	3371-4-1.40	■	■	■	■	■
1.50	6.00	3.00	39	3371-4-1.50	■	■	■	■	■
1.60	6.40	3.00	39	3371-4-1.60	■	■	■	■	■
1.70	6.80	3.00	39	3371-4-1.70	■	■	■	■	■
1.80	7.20	3.00	39	3371-4-1.80	■	■	■	■	■
1.90	7.60	3.00	39	3371-4-1.90	■	■	■	■	■
2.00	8.00	3.00	39	3371-4-2.00	■	■	■	■	■
2.10	8.40	3.00	39	3371-4-2.10	■	■	■	■	■
2.20	8.80	3.00	39	3371-4-2.20	■	■	■	■	■
2.30	9.20	3.00	39	3371-4-2.30	■	■	■	■	■
2.40	9.60	3.00	39	3371-4-2.40	■	■	■	■	■
2.50	10.00	3.00	39	3371-4-2.50	■	■	■	■	■
2.60	10.40	3.00	39	3371-4-2.60	■	■	■	■	■
2.70	10.80	3.00	39	3371-4-2.70	■	■	■	■	■
2.80	11.20	3.00	39	3371-4-2.80	■	■	■	■	■
2.90	11.60	3.00	39	3371-4-2.90	■	■	■	■	■

MICRO-LINE

Micro-fraises de précision

Mikropräzisionsfräser

Precision micro end mills

3371-5

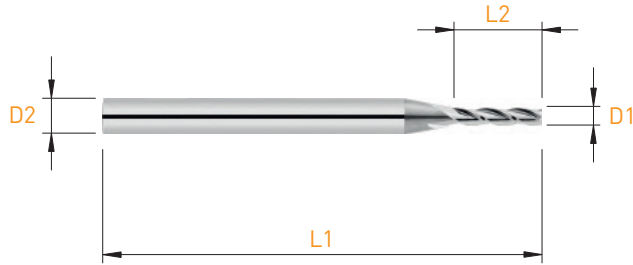

D1 +0.005 / -0.010	L2	D2 h4	L1	Art. N°	N	TiAlN	STF	TiCN	DLC
0.50	2.50	3.00	39	3371-5-0.50	■	■	■	■	■
0.60	3.00	3.00	39	3371-5-0.60	■	■	■	■	■
0.70	3.50	3.00	39	3371-5-0.70	■	■	■	■	■
0.80	4.00	3.00	39	3371-5-0.80	■	■	■	■	■
0.90	4.50	3.00	39	3371-5-0.90	■	■	■	■	■
1.00	5.00	3.00	39	3371-5-1.00	■	■	■	■	■
1.10	5.50	3.00	39	3371-5-1.10	■	■	■	■	■
1.20	6.00	3.00	39	3371-5-1.20	■	■	■	■	■
1.50	7.50	3.00	39	3371-5-1.50	■	■	■	■	■
2.00	10.00	3.00	39	3371-5-2.00	■	■	■	■	■
2.50	12.50	3.00	39	3371-5-2.50	■	■	■	■	■

Micro-fraises de précision

Mikropräzisionsfräser

Precision micro end mills

3371-8

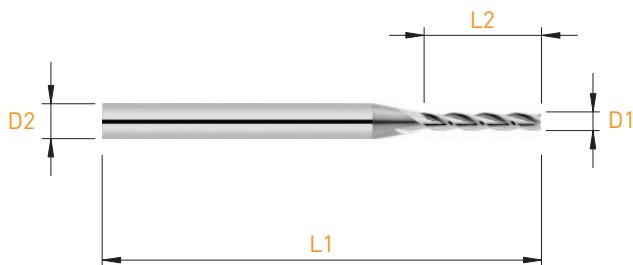

MD VHM HM λ 30° Sharp Corner 8xD1 Z=3

D1 +0.005 / -0.010	L2	D2 h4 Ø3.0 h5 Ø4.0	L1	Art. N°	Z	TiAIN	STF	TiCN	DLC
0.50	4.00	3.00	39	3371-8-0.50	■	■	■	■	■
0.60	5.00	3.00	39	3371-8-0.60	■	■	■	■	■
0.70	5.60	3.00	39	3371-8-0.70	■	■	■	■	■
0.80	6.00	3.00	39	3371-8-0.80	■	■	■	■	■
0.90	7.20	3.00	39	3371-8-0.90	■	■	■	■	■
1.00	8.00	3.00	39	3371-8-1.00	■	■	■	■	■
1.20	9.00	3.00	39	3371-8-1.20	■	■	■	■	■
1.30	11.00	3.00	39	3371-8-1.30	■	■	■	■	■
1.50	12.00	4.00	50	3371-8-1.50	■	■	■	■	■
2.00	16.00	4.00	50	3371-8-2.00	■	■	■	■	■
2.50	20.00	4.00	50	3371-8-2.50	■	■	■	■	■

MICRO-LINE

Micro-fraises de précision

Mikropräzisionsfräser

Precision micro end mills

3375-2.5

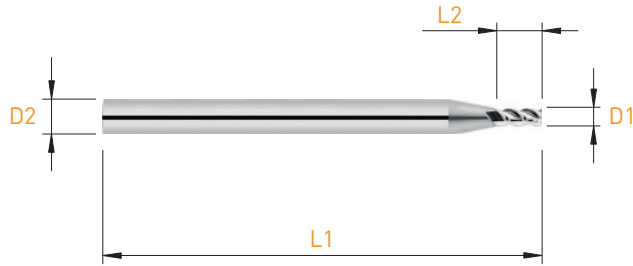

D1 +0.005 / -0.010	L2	D2 h4	L1	Art. N°	Z	TiAlN	STF	TiCN	DLC
0.30	0.80	3.00	39	3375-2.5-0.30	■	■	■	■	■
0.40	1.00	3.00	39	3375-2.5-0.40	■	■	■	■	■
0.50	1.30	3.00	39	3375-2.5-0.50	■	■	■	■	■
0.60	1.50	3.00	39	3375-2.5-0.60	■	■	■	■	■
0.70	1.70	3.00	39	3375-2.5-0.70	■	■	■	■	■
0.80	2.00	3.00	39	3375-2.5-0.80	■	■	■	■	■
0.90	2.30	3.00	39	3375-2.5-0.90	■	■	■	■	■
1.00	2.50	3.00	39	3375-2.5-1.00	■	■	■	■	■
1.10	2.80	3.00	39	3375-2.5-1.10	■	■	■	■	■
1.20	3.00	3.00	39	3375-2.5-1.20	■	■	■	■	■
1.30	3.30	3.00	39	3375-2.5-1.30	■	■	■	■	■
1.40	3.50	3.00	39	3375-2.5-1.40	■	■	■	■	■
1.50	3.80	3.00	39	3375-2.5-1.50	■	■	■	■	■
1.60	4.00	3.00	39	3375-2.5-1.60	■	■	■	■	■
1.70	4.30	3.00	39	3375-2.5-1.70	■	■	■	■	■
1.80	4.50	3.00	39	3375-2.5-1.80	■	■	■	■	■
1.90	4.80	3.00	39	3375-2.5-1.90	■	■	■	■	■
2.00	5.00	3.00	39	3375-2.5-2.00	■	■	■	■	■
2.10	5.30	3.00	39	3375-2.5-2.10	■	■	■	■	■
2.20	5.50	3.00	39	3375-2.5-2.20	■	■	■	■	■
2.30	5.80	3.00	39	3375-2.5-2.30	■	■	■	■	■
2.40	6.00	3.00	39	3375-2.5-2.40	■	■	■	■	■
2.50	6.30	3.00	39	3375-2.5-2.50	■	■	■	■	■
2.60	6.50	3.00	39	3375-2.5-2.60	■	■	■	■	■
2.70	6.80	3.00	39	3375-2.5-2.70	■	■	■	■	■
2.80	7.00	3.00	39	3375-2.5-2.80	■	■	■	■	■
2.90	7.30	3.00	39	3375-2.5-2.90	■	■	■	■	■

Micro-fraises de précision

Mikropräzisionsfräser

Precision micro end mills

DHD3371-1.5

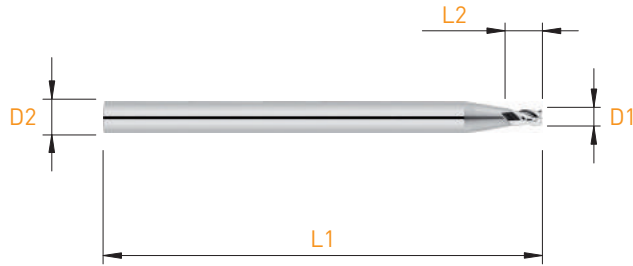

MD VHM HM	λ 36° 38° 40°	Sharp Corner		1.5xD1	Z=3	
-----------------	-----------------------------	-----------------	--	--------	-----	--

DHD Denture à pas irrégulier, angle d'hélice différent pour chaque dent
 Ungleiche Teilung, unterschiedlicher Dratlwinkel
 Uneven tooth pitch, different helix angle per tooth

D1 +0.005 / -0.010	L2	D2 h4	L1	Art. N°	Z	TiAIN	STF	TiCN	DLC
0.30	0.45	3.00	39	DHD3371-1.5-0.30	■	■	■	■	■
0.40	0.60	3.00	39	DHD3371-1.5-0.40	■	■	■	■	■
0.50	0.75	3.00	39	DHD3371-1.5-0.50	■	■	■	■	■
0.60	0.90	3.00	39	DHD3371-1.5-0.60	■	■	■	■	■
0.70	1.05	3.00	39	DHD3371-1.5-0.70	■	■	■	■	■
0.80	1.20	3.00	39	DHD3371-1.5-0.80	■	■	■	■	■
0.90	1.35	3.00	39	DHD3371-1.5-0.90	■	■	■	■	■
1.00	1.50	3.00	39	DHD3371-1.5-1.00	■	■	■	■	■
1.10	1.65	3.00	39	DHD3371-1.5-1.10	■	■	■	■	■
1.20	1.80	3.00	39	DHD3371-1.5-1.20	■	■	■	■	■
1.30	1.95	3.00	39	DHD3371-1.5-1.30	■	■	■	■	■
1.40	2.10	3.00	39	DHD3371-1.5-1.40	■	■	■	■	■
1.50	2.25	3.00	39	DHD3371-1.5-1.50	■	■	■	■	■
1.60	2.40	3.00	39	DHD3371-1.5-1.60	■	■	■	■	■
1.70	2.55	3.00	39	DHD3371-1.5-1.70	■	■	■	■	■
1.80	2.70	3.00	39	DHD3371-1.5-1.80	■	■	■	■	■
1.90	2.85	3.00	39	DHD3371-1.5-1.90	■	■	■	■	■
2.00	3.00	3.00	39	DHD3371-1.5-2.00	■	■	■	■	■
2.50	3.75	3.00	39	DHD3371-1.5-2.50	■	■	■	■	■

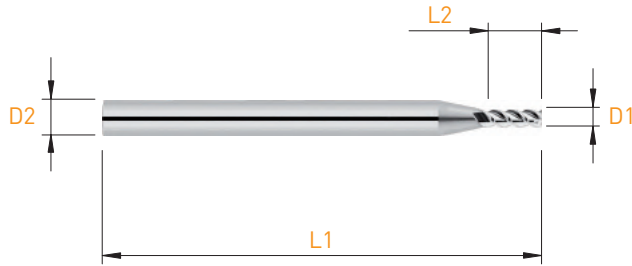

DHD Denture à pas irrégulier, angle d'hélice différent pour chaque dent
 Ungleiche Teilung, unterschiedlicher Drallwinkel
 Uneven tooth pitch, different helix angle per tooth

D1 +0.005 / -0.010	L2	D2 h4	L1	Art. N°	Z	TiAIN	STF	TiCN	DLC
0.30	0.90	3.00	39	DHD3371-3-0.30	■	■	■	■	■
0.40	1.20	3.00	39	DHD3371-3-0.40	■	■	■	■	■
0.50	1.50	3.00	39	DHD3371-3-0.50	■	■	■	■	■
0.60	1.80	3.00	39	DHD3371-3-0.60	■	■	■	■	■
0.70	2.10	3.00	39	DHD3371-3-0.70	■	■	■	■	■
0.80	2.40	3.00	39	DHD3371-3-0.80	■	■	■	■	■
0.90	2.70	3.00	39	DHD3371-3-0.90	■	■	■	■	■
1.00	3.00	3.00	39	DHD3371-3-1.00	■	■	■	■	■
1.10	3.30	3.00	39	DHD3371-3-1.10	■	■	■	■	■
1.20	3.60	3.00	39	DHD3371-3-1.20	■	■	■	■	■
1.30	3.90	3.00	39	DHD3371-3-1.30	■	■	■	■	■
1.40	4.20	3.00	39	DHD3371-3-1.40	■	■	■	■	■
1.50	4.50	3.00	39	DHD3371-3-1.50	■	■	■	■	■
1.60	4.80	3.00	39	DHD3371-3-1.60	■	■	■	■	■
1.70	5.10	3.00	39	DHD3371-3-1.70	■	■	■	■	■
1.80	5.40	3.00	39	DHD3371-3-1.80	■	■	■	■	■
1.90	5.70	3.00	39	DHD3371-3-1.90	■	■	■	■	■
2.00	6.00	3.00	39	DHD3371-3-2.00	■	■	■	■	■
2.50	7.50	3.00	39	DHD3371-3-2.50	■	■	■	■	■

Micro-fraises de précision

Mikropräzisionsfräser

Precision micro end mills

3370S-3X

new

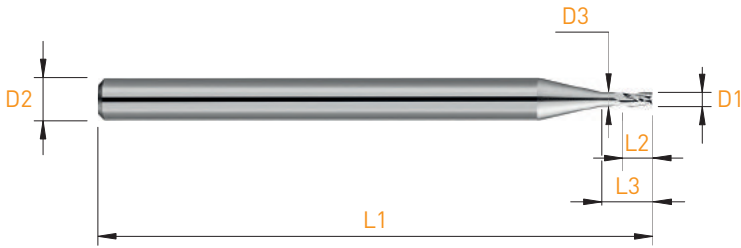

MD VHM HM $\lambda 30^\circ$ Sharp Corner L3 3xD1 Z=3

D1 +0.005 / -0.010	L2	L3	D3	D2 h4 Ø3.0 h5 Ø6.0	L1	Art. N°	Z	TiAlN	STF	TiCN	DLC
0.30	0.60	0.90	0.27	3.00	39	3370S-3X-0.30	■	■	■	■	■
0.40	0.80	1.20	0.37	3.00	39	3370S-3X-0.40	■	■	■	■	■
0.50	1.00	1.50	0.45	3.00	39	3370S-3X-0.50	■	■	■	■	■
0.60	1.20	1.80	0.55	3.00	39	3370S-3X-0.60	■	■	■	■	■
0.70	1.40	2.10	0.65	3.00	39	3370S-3X-0.70	■	■	■	■	■
0.80	1.60	2.40	0.75	3.00	39	3370S-3X-0.80	■	■	■	■	■
0.90	1.80	2.70	0.85	3.00	39	3370S-3X-0.90	■	■	■	■	■
1.00	2.00	3.00	0.95	3.00	39	3370S-3X-1.00	■	■	■	■	■
1.10	2.20	3.30	1.05	3.00	39	3370S-3X-1.10	■	■	■	■	■
1.20	2.40	3.60	1.15	3.00	39	3370S-3X-1.20	■	■	■	■	■
1.30	2.60	3.90	1.25	3.00	39	3370S-3X-1.30	■	■	■	■	■
1.40	2.80	4.20	1.35	3.00	39	3370S-3X-1.40	■	■	■	■	■
1.50	3.00	4.50	1.45	3.00	39	3370S-3X-1.50	■	■	■	■	■
1.60	3.20	4.80	1.55	3.00	39	3370S-3X-1.60	■	■	■	■	■
1.70	3.40	5.10	1.65	3.00	39	3370S-3X-1.70	■	■	■	■	■
1.80	3.60	5.40	1.75	3.00	39	3370S-3X-1.80	■	■	■	■	■
1.90	3.80	5.70	1.85	3.00	39	3370S-3X-1.90	■	■	■	■	■
2.00	4.00	6.00	1.95	6.00	50	3370S-3X-2.00	■	■	■	■	■
2.10	4.20	6.30	2.05	6.00	50	3370S-3X-2.10	■	■	■	■	■
2.20	4.40	6.60	2.15	6.00	50	3370S-3X-2.20	■	■	■	■	■
2.30	4.60	6.90	2.25	6.00	50	3370S-3X-2.30	■	■	■	■	■
2.40	4.80	7.20	2.35	6.00	50	3370S-3X-2.40	■	■	■	■	■
2.50	5.00	7.50	2.45	6.00	50	3370S-3X-2.50	■	■	■	■	■
3.00	6.00	9.00	2.95	6.00	50	3370S-3X-3.00	■	■	■	■	■

new

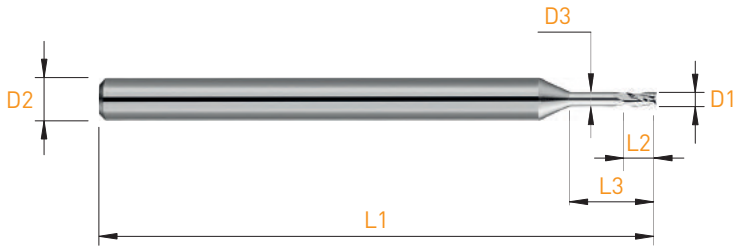

D1 +0.005 / -0.010	L2	L3	D3	D2 h4 Ø3.0 h5 Ø6.0	L1	Art. N°	Z	TiAIN	STF	TiCN	DLC
0.30	0.60	1.80	0.27	3.00	39	3370S-6X-0.30	■	■	■	■	■
0.40	0.80	2.40	0.37	3.00	39	3370S-6X-0.40	■	■	■	■	■
0.50	1.00	3.00	0.45	3.00	39	3370S-6X-0.50	■	■	■	■	■
0.60	1.20	3.60	0.55	3.00	39	3370S-6X-0.60	■	■	■	■	■
0.70	1.40	4.20	0.65	3.00	39	3370S-6X-0.70	■	■	■	■	■
0.80	1.60	4.80	0.75	3.00	39	3370S-6X-0.80	■	■	■	■	■
0.90	1.80	5.40	0.85	3.00	39	3370S-6X-0.90	■	■	■	■	■
1.00	2.00	6.00	0.95	3.00	39	3370S-6X-1.00	■	■	■	■	■
1.10	2.20	6.60	1.05	3.00	39	3370S-6X-1.10	■	■	■	■	■
1.20	2.40	7.20	1.15	3.00	39	3370S-6X-1.20	■	■	■	■	■
1.30	2.60	7.80	1.25	3.00	39	3370S-6X-1.30	■	■	■	■	■
1.40	2.80	8.40	1.35	3.00	39	3370S-6X-1.40	■	■	■	■	■
1.50	3.00	9.00	1.45	3.00	39	3370S-6X-1.50	■	■	■	■	■
1.60	3.20	9.60	1.55	3.00	39	3370S-6X-1.60	■	■	■	■	■
1.70	3.40	10.20	1.65	3.00	39	3370S-6X-1.70	■	■	■	■	■
1.80	3.60	10.80	1.75	3.00	39	3370S-6X-1.80	■	■	■	■	■
1.90	3.80	11.40	1.85	3.00	39	3370S-6X-1.90	■	■	■	■	■
2.00	4.00	12.00	1.95	6.00	50	3370S-6X-2.00	■	■	■	■	■
2.10	4.20	12.60	2.05	6.00	50	3370S-6X-2.10	■	■	■	■	■
2.20	4.40	13.20	2.15	6.00	50	3370S-6X-2.20	■	■	■	■	■
2.30	4.60	13.80	2.25	6.00	50	3370S-6X-2.30	■	■	■	■	■
2.40	4.80	14.40	2.35	6.00	50	3370S-6X-2.40	■	■	■	■	■
2.50	5.00	15.00	2.45	6.00	50	3370S-6X-2.50	■	■	■	■	■
3.00	6.00	18.00	2.95	6.00	50	3370S-6X-3.00	■	■	■	■	■

Micro-fraises de précision

Mikropräzisionsfräser

Precision micro end mills

3370S-9X

new



MD VHM HM λ 30° Sharp Corner  L3 9xD1 Z=3 

D1 +0.005 / -0.010	L2	L3	D3	D2 h4 Ø3.0 h5 Ø6.0	L1	Art. N°	Z	TiAIN	STF	TiCN	DLC
0.40	0.80	3.60	0.37	3.00	39	3370S-9X-0.40	■	■	■	■	■
0.50	1.00	4.50	0.45	3.00	39	3370S-9X-0.50	■	■	■	■	■
0.60	1.20	5.40	0.55	3.00	39	3370S-9X-0.60	■	■	■	■	■
0.70	1.40	6.30	0.65	3.00	39	3370S-9X-0.70	■	■	■	■	■
0.80	1.60	7.20	0.75	3.00	39	3370S-9X-0.80	■	■	■	■	■
0.90	1.80	8.10	0.85	3.00	39	3370S-9X-0.90	■	■	■	■	■
1.00	2.00	9.00	0.95	3.00	39	3370S-9X-1.00	■	■	■	■	■
1.10	2.20	9.90	1.05	3.00	39	3370S-9X-1.10	■	■	■	■	■
1.20	2.40	10.80	1.15	3.00	39	3370S-9X-1.20	■	■	■	■	■
1.30	2.60	11.70	1.25	3.00	39	3370S-9X-1.30	■	■	■	■	■
1.40	2.80	12.60	1.35	3.00	39	3370S-9X-1.40	■	■	■	■	■
1.50	3.00	13.50	1.45	3.00	39	3370S-9X-1.50	■	■	■	■	■
1.60	3.20	14.40	1.55	3.00	39	3370S-9X-1.60	■	■	■	■	■
1.70	3.40	15.30	1.65	3.00	39	3370S-9X-1.70	■	■	■	■	■
1.80	3.60	16.20	1.75	3.00	39	3370S-9X-1.80	■	■	■	■	■
1.90	3.80	17.10	1.85	3.00	39	3370S-9X-1.90	■	■	■	■	■
2.00	4.00	18.00	1.95	6.00	50	3370S-9X-2.00	■	■	■	■	■
2.10	4.20	18.90	2.05	6.00	50	3370S-9X-2.10	■	■	■	■	■
2.20	4.40	19.80	2.15	6.00	50	3370S-9X-2.20	■	■	■	■	■
2.30	4.60	20.70	2.25	6.00	50	3370S-9X-2.30	■	■	■	■	■
2.40	4.80	21.60	2.35	6.00	50	3370S-9X-2.40	■	■	■	■	■
2.50	5.00	22.50	2.45	6.00	50	3370S-9X-2.50	■	■	■	■	■
3.00	6.00	27.00	2.95	6.00	50	3370S-9X-3.00	■	■	■	■	■

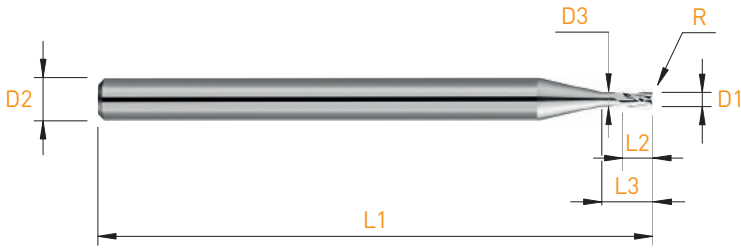

D1 +0.005 / -0.010	R +/- 0.02	L2	L3	D3	D2 h4 Ø3.0 h5 Ø6.0	L1	Art. N°	Z	TiAlN	STF	TiCN	DLC
0.30	0.05	0.60	0.90	0.27	3.00	39	3379T-3X-0.30	■	■	■	■	■
0.40	0.05	0.80	1.20	0.37	3.00	39	3379T-3X-0.40	■	■	■	■	■
0.50	0.05	1.00	1.50	0.45	3.00	39	3379T-3X-0.50	■	■	■	■	■
0.60	0.05	1.20	1.80	0.55	3.00	39	3379T-3X-0.60	■	■	■	■	■
0.70	0.05	1.40	2.10	0.65	3.00	39	3379T-3X-0.70	■	■	■	■	■
0.80	0.05	1.60	2.40	0.75	3.00	39	3379T-3X-0.80	■	■	■	■	■
0.90	0.05	1.80	2.70	0.85	3.00	39	3379T-3X-0.90	■	■	■	■	■
1.00	0.10	2.00	3.00	0.95	3.00	39	3379T-3X-1.00	■	■	■	■	■
1.10	0.10	2.20	3.30	1.05	3.00	39	3379T-3X-1.10	■	■	■	■	■
1.20	0.10	2.40	3.60	1.15	3.00	39	3379T-3X-1.20	■	■	■	■	■
1.30	0.10	2.60	3.90	1.25	3.00	39	3379T-3X-1.30	■	■	■	■	■
1.40	0.10	2.80	4.20	1.35	3.00	39	3379T-3X-1.40	■	■	■	■	■
1.50	0.20	3.00	4.50	1.45	3.00	39	3379T-3X-1.50	■	■	■	■	■
1.60	0.20	3.20	4.80	1.55	3.00	39	3379T-3X-1.60	■	■	■	■	■
1.70	0.20	3.40	5.10	1.65	3.00	39	3379T-3X-1.70	■	■	■	■	■
1.80	0.20	3.60	5.40	1.75	3.00	39	3379T-3X-1.80	■	■	■	■	■
1.90	0.20	3.80	5.70	1.85	3.00	39	3379T-3X-1.90	■	■	■	■	■
2.00	0.20	4.00	6.00	1.95	6.00	50	3379T-3X-2.00	■	■	■	■	■
2.10	0.20	4.20	6.30	2.05	6.00	50	3379T-3X-2.10	■	■	■	■	■
2.20	0.20	4.40	6.60	2.15	6.00	50	3379T-3X-2.20	■	■	■	■	■
2.30	0.20	4.60	6.90	2.25	6.00	50	3379T-3X-2.30	■	■	■	■	■
2.40	0.20	4.80	7.20	2.35	6.00	50	3379T-3X-2.40	■	■	■	■	■
2.50	0.20	5.00	7.50	2.45	6.00	50	3379T-3X-2.50	■	■	■	■	■
3.00	0.20	6.00	9.00	2.95	6.00	50	3379T-3X-3.00	■	■	■	■	■

Micro-fraises de précision

Mikropräzisionsfräser

Precision micro end mills

3379T-6X

new

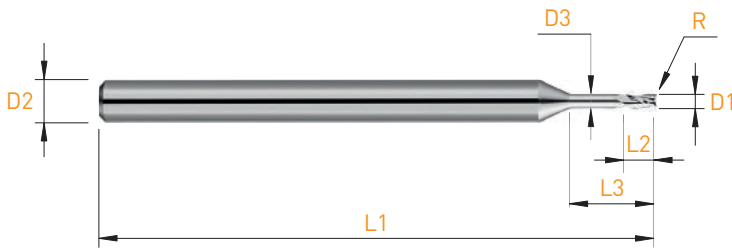

D1 +0.005 / -0.010	R +/- 0.02	L2	L3	D3	D2 h4 Ø3.0 h5 Ø6.0	L1	Art. N°	Z	TiAlN	STF	TiCN	DLC
0.30	0.05	0.60	1.80	0.27	3.00	39	3379T-6X-0.30	■	■	■	■	■
0.40	0.05	0.80	2.40	0.37	3.00	39	3379T-6X-0.40	■	■	■	■	■
0.50	0.05	1.00	3.00	0.45	3.00	39	3379T-6X-0.50	■	■	■	■	■
0.60	0.05	1.20	3.60	0.55	3.00	39	3379T-6X-0.60	■	■	■	■	■
0.70	0.05	1.40	4.20	0.65	3.00	39	3379T-6X-0.70	■	■	■	■	■
0.80	0.05	1.60	4.80	0.75	3.00	39	3379T-6X-0.80	■	■	■	■	■
0.90	0.05	1.80	5.40	0.85	3.00	39	3379T-6X-0.90	■	■	■	■	■
1.00	0.10	2.00	6.00	0.95	3.00	39	3379T-6X-1.00	■	■	■	■	■
1.10	0.10	2.20	6.60	1.05	3.00	39	3379T-6X-1.10	■	■	■	■	■
1.20	0.10	2.40	7.20	1.15	3.00	39	3379T-6X-1.20	■	■	■	■	■
1.30	0.10	2.60	7.80	1.25	3.00	39	3379T-6X-1.30	■	■	■	■	■
1.40	0.10	2.80	8.40	1.35	3.00	39	3379T-6X-1.40	■	■	■	■	■
1.50	0.20	3.00	9.00	1.45	3.00	39	3379T-6X-1.50	■	■	■	■	■
1.60	0.20	3.20	9.60	1.55	3.00	39	3379T-6X-1.60	■	■	■	■	■
1.70	0.20	3.40	10.20	1.65	3.00	39	3379T-6X-1.70	■	■	■	■	■
1.80	0.20	3.60	10.80	1.75	3.00	39	3379T-6X-1.80	■	■	■	■	■
1.90	0.20	3.80	11.40	1.85	3.00	39	3379T-6X-1.90	■	■	■	■	■
2.00	0.20	4.00	12.00	1.95	6.00	50	3379T-6X-2.00	■	■	■	■	■
2.10	0.20	4.20	12.60	2.05	6.00	50	3379T-6X-2.10	■	■	■	■	■
2.20	0.20	4.40	13.20	2.15	6.00	50	3379T-6X-2.20	■	■	■	■	■
2.30	0.20	4.60	13.80	2.25	6.00	50	3379T-6X-2.30	■	■	■	■	■
2.40	0.20	4.80	14.40	2.35	6.00	50	3379T-6X-2.40	■	■	■	■	■
2.50	0.20	5.00	15.00	2.45	6.00	50	3379T-6X-2.50	■	■	■	■	■
3.00	0.20	6.00	18.00	2.95	6.00	50	3379T-6X-3.00	■	■	■	■	■

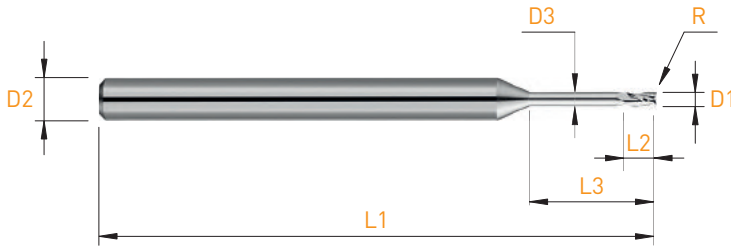

D1 +0.005 / -0.010	R +/- 0.02	L2	L3	D3	D2 h4 Ø3.0 h5 Ø6.0	L1	Art. N°	Z	TiAlN	STF	TiCN	DLC
0.40	0.05	0.80	3.60	0.37	3.00	39	3379T-9X-0.40	■	■	■	■	■
0.50	0.05	1.00	4.50	0.45	3.00	39	3379T-9X-0.50	■	■	■	■	■
0.60	0.05	1.20	5.40	0.55	3.00	39	3379T-9X-0.60	■	■	■	■	■
0.70	0.05	1.40	6.30	0.65	3.00	39	3379T-9X-0.70	■	■	■	■	■
0.80	0.05	1.60	7.20	0.75	3.00	39	3379T-9X-0.80	■	■	■	■	■
0.90	0.05	1.80	8.10	0.85	3.00	39	3379T-9X-0.90	■	■	■	■	■
1.00	0.10	2.00	9.00	0.95	3.00	39	3379T-9X-1.00	■	■	■	■	■
1.10	0.10	2.20	9.90	1.05	3.00	39	3379T-9X-1.10	■	■	■	■	■
1.20	0.10	2.40	10.80	1.15	3.00	39	3379T-9X-1.20	■	■	■	■	■
1.30	0.10	2.60	11.70	1.25	3.00	39	3379T-9X-1.30	■	■	■	■	■
1.40	0.10	2.80	12.60	1.35	3.00	39	3379T-9X-1.40	■	■	■	■	■
1.50	0.20	3.00	13.50	1.45	3.00	39	3379T-9X-1.50	■	■	■	■	■
1.60	0.20	3.20	14.40	1.55	3.00	39	3379T-9X-1.60	■	■	■	■	■
1.70	0.20	3.40	15.30	1.65	3.00	39	3379T-9X-1.70	■	■	■	■	■
1.80	0.20	3.60	16.20	1.75	3.00	39	3379T-9X-1.80	■	■	■	■	■
1.90	0.20	3.80	17.10	1.85	3.00	39	3379T-9X-1.90	■	■	■	■	■
2.00	0.20	4.00	18.00	1.95	6.00	50	3379T-9X-2.00	■	■	■	■	■
2.10	0.20	4.20	18.90	2.05	6.00	50	3379T-9X-2.10	■	■	■	■	■
2.20	0.20	4.40	19.80	2.15	6.00	50	3379T-9X-2.20	■	■	■	■	■
2.30	0.20	4.60	20.70	2.25	6.00	50	3379T-9X-2.30	■	■	■	■	■
2.40	0.20	4.80	21.60	2.35	6.00	50	3379T-9X-2.40	■	■	■	■	■
2.50	0.20	5.00	22.50	2.45	6.00	50	3379T-9X-2.50	■	■	■	■	■
3.00	0.20	6.00	27.00	2.95	6.00	50	3379T-9X-3.00	■	■	■	■	■

Micro-fraises de précision

Mikropräzisionsfräser

Precision micro end mills

3471-1.5

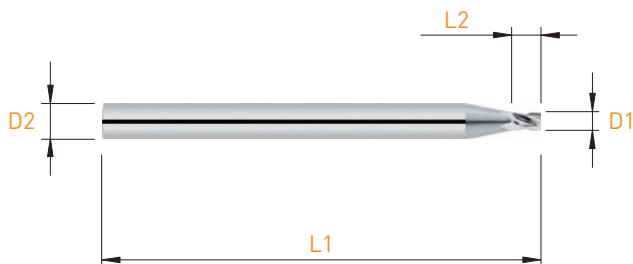

D1 +0.005 / -0.010	L2	D2 h4	L1	Art. N°	N	TiAlN	STF	TiCN	DLC
0.30	0.45	3.00	39	3471-1.5-0.30	■	■	■	■	■
0.40	0.60	3.00	39	3471-1.5-0.40	■	■	■	■	■
0.50	0.75	3.00	39	3471-1.5-0.50	■	■	■	■	■
0.60	0.90	3.00	39	3471-1.5-0.60	■	■	■	■	■
0.70	1.05	3.00	39	3471-1.5-0.70	■	■	■	■	■
0.80	1.20	3.00	39	3471-1.5-0.80	■	■	■	■	■
0.90	1.35	3.00	39	3471-1.5-0.90	■	■	■	■	■
1.00	1.50	3.00	39	3471-1.5-1.00	■	■	■	■	■
1.10	1.65	3.00	39	3471-1.5-1.10	■	■	■	■	■
1.20	1.80	3.00	39	3471-1.5-1.20	■	■	■	■	■
1.30	1.95	3.00	39	3471-1.5-1.30	■	■	■	■	■
1.40	2.10	3.00	39	3471-1.5-1.40	■	■	■	■	■
1.50	2.25	3.00	39	3471-1.5-1.50	■	■	■	■	■
1.60	2.40	3.00	39	3471-1.5-1.60	■	■	■	■	■
1.70	2.55	3.00	39	3471-1.5-1.70	■	■	■	■	■
1.80	2.70	3.00	39	3471-1.5-1.80	■	■	■	■	■
1.90	2.85	3.00	39	3471-1.5-1.90	■	■	■	■	■
2.00	3.00	3.00	39	3471-1.5-2.00	■	■	■	■	■
2.10	3.15	3.00	39	3471-1.5-2.10	■	■	■	■	■
2.20	3.30	3.00	39	3471-1.5-2.20	■	■	■	■	■
2.30	3.45	3.00	39	3471-1.5-2.30	■	■	■	■	■
2.40	3.60	3.00	39	3471-1.5-2.40	■	■	■	■	■
2.50	3.75	3.00	39	3471-1.5-2.50	■	■	■	■	■
2.60	3.90	3.00	39	3471-1.5-2.60	■	■	■	■	■
2.70	4.05	3.00	39	3471-1.5-2.70	■	■	■	■	■
2.80	4.20	3.00	39	3471-1.5-2.80	■	■	■	■	■
2.90	4.35	3.00	39	3471-1.5-2.90	■	■	■	■	■

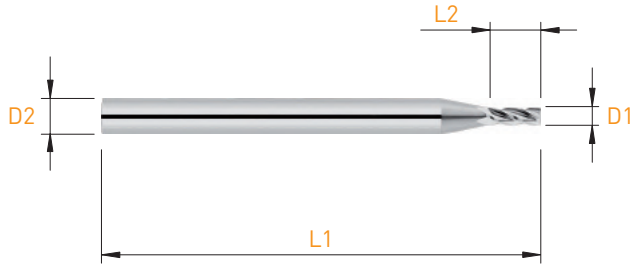

D1 +0.005 / -0.010	L2	D2 h4	L1	Art. N°	N	TiAlN	STF	TiCN	DLC
0.30	0.90	3.00	39	3471-3-0.30	■	■	■	■	■
0.40	1.20	3.00	39	3471-3-0.40	■	■	■	■	■
0.50	1.50	3.00	39	3471-3-0.50	■	■	■	■	■
0.55	1.70	3.00	39	3471-3-0.55	■	■	■	■	■
0.60	1.80	3.00	39	3471-3-0.60	■	■	■	■	■
0.70	2.10	3.00	39	3471-3-0.70	■	■	■	■	■
0.75	2.30	3.00	39	3471-3-0.75	■	■	■	■	■
0.80	2.40	3.00	39	3471-3-0.80	■	■	■	■	■
0.85	2.60	3.00	39	3471-3-0.85	■	■	■	■	■
0.90	2.70	3.00	39	3471-3-0.90	■	■	■	■	■
0.95	2.90	3.00	39	3471-3-0.95	■	■	■	■	■
1.00	3.00	3.00	39	3471-3-1.00	■	■	■	■	■
1.10	3.30	3.00	39	3471-3-1.10	■	■	■	■	■
1.20	3.60	3.00	39	3471-3-1.20	■	■	■	■	■
1.30	3.90	3.00	39	3471-3-1.30	■	■	■	■	■
1.40	4.20	3.00	39	3471-3-1.40	■	■	■	■	■
1.50	4.50	3.00	39	3471-3-1.50	■	■	■	■	■
1.60	4.80	3.00	39	3471-3-1.60	■	■	■	■	■
1.70	5.10	3.00	39	3471-3-1.70	■	■	■	■	■
1.80	5.40	3.00	39	3471-3-1.80	■	■	■	■	■
1.90	5.70	3.00	39	3471-3-1.90	■	■	■	■	■
2.00	6.00	3.00	39	3471-3-2.00	■	■	■	■	■
2.10	6.30	3.00	39	3471-3-2.10	■	■	■	■	■
2.20	6.60	3.00	39	3471-3-2.20	■	■	■	■	■
2.30	6.90	3.00	39	3471-3-2.30	■	■	■	■	■
2.40	7.20	3.00	39	3471-3-2.40	■	■	■	■	■
2.50	7.50	3.00	39	3471-3-2.50	■	■	■	■	■
2.60	7.80	3.00	39	3471-3-2.60	■	■	■	■	■
2.70	8.10	3.00	39	3471-3-2.70	■	■	■	■	■
2.80	8.40	3.00	39	3471-3-2.80	■	■	■	■	■
2.90	8.70	3.00	39	3471-3-2.90	■	■	■	■	■

Micro-fraises de précision

Mikropräzisionsfräser

Precision micro end mills

DHP3471-3

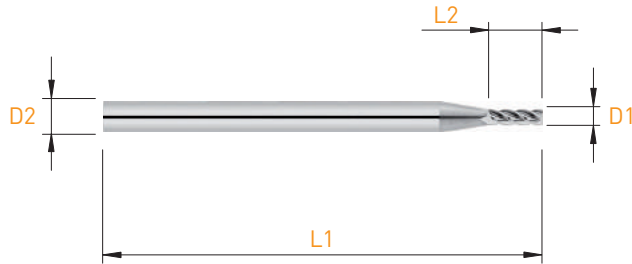

DHP Denture à pas irrégulier, angle d'hélice progressive
 Ungleiche Teilung, progressive Drallwinkel
 Uneven tooth pitch, progressive helix angle

D1 +0.005 / -0.010	L2	D2 h4	L1	Art. N°	N	TiAlN	STF	TiCN	DLC
0.50	1.50	3.00	39	DHP3471-3-0.50	■	■	■	■	■
0.60	1.80	3.00	39	DHP3471-3-0.60	■	■	■	■	■
0.70	2.10	3.00	39	DHP3471-3-0.70	■	■	■	■	■
0.80	2.40	3.00	39	DHP3471-3-0.80	■	■	■	■	■
0.90	2.70	3.00	39	DHP3471-3-0.90	■	■	■	■	■
1.00	3.00	3.00	39	DHP3471-3-1.00	■	■	■	■	■
1.10	3.30	3.00	39	DHP3471-3-1.10	■	■	■	■	■
1.20	3.60	3.00	39	DHP3471-3-1.20	■	■	■	■	■
1.30	3.90	3.00	39	DHP3471-3-1.30	■	■	■	■	■
1.40	4.20	3.00	39	DHP3471-3-1.40	■	■	■	■	■
1.50	4.50	3.00	39	DHP3471-3-1.50	■	■	■	■	■
1.60	4.80	3.00	39	DHP3471-3-1.60	■	■	■	■	■
1.70	5.10	3.00	39	DHP3471-3-1.70	■	■	■	■	■
1.80	5.40	3.00	39	DHP3471-3-1.80	■	■	■	■	■
1.90	5.70	3.00	39	DHP3471-3-1.90	■	■	■	■	■
2.00	6.00	3.00	39	DHP3471-3-2.00	■	■	■	■	■
2.50	7.50	3.00	39	DHP3471-3-2.50	■	■	■	■	■

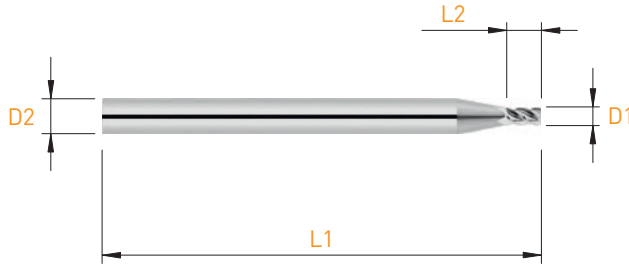

D1 +0.005 / -0.010	L2	D2 h4	L1	Art. N°	Z	TiAIN	STF	TiCN	DLC
0.30	0.60	3.00	39	3472-2-0.30	■	■	■	■	■
0.40	0.80	3.00	39	3472-2-0.40	■	■	■	■	■
0.50	1.00	3.00	39	3472-2-0.50	■	■	■	■	■
0.60	1.20	3.00	39	3472-2-0.60	■	■	■	■	■
0.70	1.40	3.00	39	3472-2-0.70	■	■	■	■	■
0.80	1.60	3.00	39	3472-2-0.80	■	■	■	■	■
0.90	1.80	3.00	39	3472-2-0.90	■	■	■	■	■
1.00	2.00	3.00	39	3472-2-1.00	■	■	■	■	■
1.10	2.20	3.00	39	3472-2-1.10	■	■	■	■	■
1.20	2.40	3.00	39	3472-2-1.20	■	■	■	■	■
1.30	2.60	3.00	39	3472-2-1.30	■	■	■	■	■
1.40	2.80	3.00	39	3472-2-1.40	■	■	■	■	■
1.50	3.00	3.00	39	3472-2-1.50	■	■	■	■	■
1.60	3.20	3.00	39	3472-2-1.60	■	■	■	■	■
1.70	3.40	3.00	39	3472-2-1.70	■	■	■	■	■
1.80	3.60	3.00	39	3472-2-1.80	■	■	■	■	■
1.90	3.80	3.00	39	3472-2-1.90	■	■	■	■	■
2.00	4.00	3.00	39	3472-2-2.00	■	■	■	■	■
2.10	4.20	3.00	39	3472-2-2.10	■	■	■	■	■
2.20	4.40	3.00	39	3472-2-2.20	■	■	■	■	■
2.30	4.60	3.00	39	3472-2-2.30	■	■	■	■	■
2.40	4.80	3.00	39	3472-2-2.40	■	■	■	■	■
2.50	5.00	3.00	39	3472-2-2.50	■	■	■	■	■
2.60	5.20	3.00	39	3472-2-2.60	■	■	■	■	■
2.70	5.40	3.00	39	3472-2-2.70	■	■	■	■	■
2.80	5.60	3.00	39	3472-2-2.80	■	■	■	■	■
2.90	5.80	3.00	39	3472-2-2.90	■	■	■	■	■

Micro-fraises de précision

Mikropräzisionsfräser

Precision micro end mills

3472-4

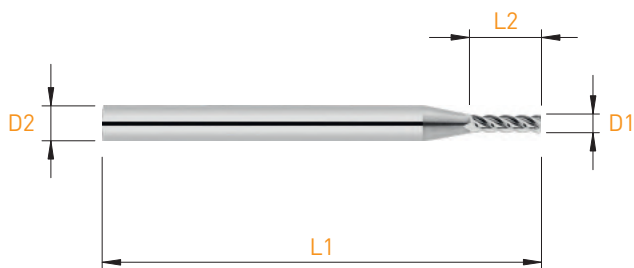

D1 +0.005 / -0.010	L2	D2 h4	L1	Art. N°	Z	TiAlN	STF	TiCN	DLC
0.40	1.60	3.00	39	3472-4-0.40	■	■	■	■	■
0.50	2.00	3.00	39	3472-4-0.50	■	■	■	■	■
0.60	2.40	3.00	39	3472-4-0.60	■	■	■	■	■
0.70	2.80	3.00	39	3472-4-0.70	■	■	■	■	■
0.80	3.20	3.00	39	3472-4-0.80	■	■	■	■	■
0.90	3.60	3.00	39	3472-4-0.90	■	■	■	■	■
1.00	4.00	3.00	39	3472-4-1.00	■	■	■	■	■
1.10	4.40	3.00	39	3472-4-1.10	■	■	■	■	■
1.20	4.80	3.00	39	3472-4-1.20	■	■	■	■	■
1.30	5.20	3.00	39	3472-4-1.30	■	■	■	■	■
1.40	5.60	3.00	39	3472-4-1.40	■	■	■	■	■
1.50	6.00	3.00	39	3472-4-1.50	■	■	■	■	■
1.60	6.40	3.00	39	3472-4-1.60	■	■	■	■	■
1.70	6.80	3.00	39	3472-4-1.70	■	■	■	■	■
1.80	7.20	3.00	39	3472-4-1.80	■	■	■	■	■
1.90	7.60	3.00	39	3472-4-1.90	■	■	■	■	■
2.00	8.00	3.00	39	3472-4-2.00	■	■	■	■	■
2.10	8.40	3.00	39	3472-4-2.10	■	■	■	■	■
2.20	8.80	3.00	39	3472-4-2.20	■	■	■	■	■
2.30	9.20	3.00	39	3472-4-2.30	■	■	■	■	■
2.40	9.60	3.00	39	3472-4-2.40	■	■	■	■	■
2.50	10.00	3.00	39	3472-4-2.50	■	■	■	■	■
2.60	10.40	3.00	39	3472-4-2.60	■	■	■	■	■
2.70	10.80	3.00	39	3472-4-2.70	■	■	■	■	■
2.80	11.20	3.00	39	3472-4-2.80	■	■	■	■	■
2.90	11.60	3.00	39	3472-4-2.90	■	■	■	■	■

MICRO-LINE

Micro-fraises de précision

Mikropräzisionsfräser

Precision micro end mills

3278-0.75

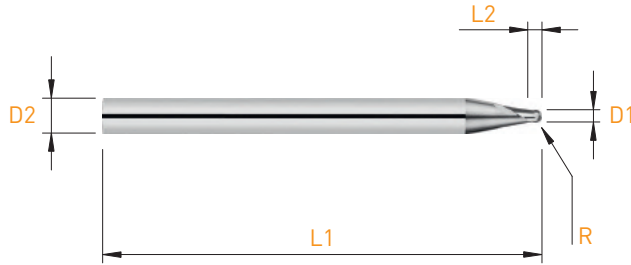

D1 +0.005 / -0.010	R	L2	D2 h4	L1	Art. N°	Z	TiAlN	STF	TiCN	DLC
0.20	0.10	0.15	3.00	39	3278-0.75-0.20	■				
0.30	0.15	0.20	3.00	39	3278-0.75-0.30	■	■	■	■	■
0.40	0.20	0.30	3.00	39	3278-0.75-0.40	■	■	■	■	■
0.50	0.25	0.35	3.00	39	3278-0.75-0.50	■	■	■	■	■
0.60	0.30	0.45	3.00	39	3278-0.75-0.60	■	■	■	■	■
0.70	0.35	0.55	3.00	39	3278-0.75-0.70	■	■	■	■	■
0.80	0.40	0.60	3.00	39	3278-0.75-0.80	■	■	■	■	■
0.90	0.45	0.70	3.00	39	3278-0.75-0.90	■	■	■	■	■
1.00	0.50	0.75	3.00	39	3278-0.75-1.00	■	■	■	■	■
1.50	0.75	1.15	3.00	39	3278-0.75-1.50	■	■	■	■	■
2.00	1.00	1.50	3.00	39	3278-0.75-2.00	■	■	■	■	■
2.50	1.25	1.90	3.00	39	3278-0.75-2.50	■	■	■	■	■

Micro-fraises de précision

Mikropräzisionsfräser

Precision micro end mills

3278-1

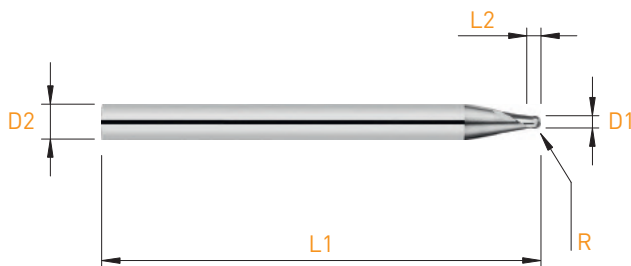

D1 +0.005 / -0.010	R	L2	D2 h4	L1	Art. N°	Z	TiAlN	STF	TiCN	DLC
0.20	0.10	0.20	3.00	39	3278-1-0.20	■				
0.30	0.15	0.30	3.00	39	3278-1-0.30	■	■	■	■	■
0.40	0.20	0.40	3.00	39	3278-1-0.40	■	■	■	■	■
0.50	0.25	0.50	3.00	39	3278-1-0.50	■	■	■	■	■
0.60	0.30	0.60	3.00	39	3278-1-0.60	■	■	■	■	■
0.70	0.35	0.70	3.00	39	3278-1-0.70	■	■	■	■	■
0.80	0.40	0.80	3.00	39	3278-1-0.80	■	■	■	■	■
0.90	0.45	0.90	3.00	39	3278-1-0.90	■	■	■	■	■
1.00	0.50	1.00	3.00	39	3278-1-1.00	■	■	■	■	■
1.10	0.55	1.10	3.00	39	3278-1-1.10	■	■	■	■	■
1.20	0.60	1.20	3.00	39	3278-1-1.20	■	■	■	■	■
1.30	0.35	1.30	3.00	39	3278-1-1.30	■	■	■	■	■
1.40	0.70	1.40	3.00	39	3278-1-1.40	■	■	■	■	■
1.50	0.75	1.50	3.00	39	3278-1-1.50	■	■	■	■	■
1.60	0.80	1.60	3.00	39	3278-1-1.60	■	■	■	■	■
1.70	0.85	1.70	3.00	39	3278-1-1.70	■	■	■	■	■
1.80	0.90	1.80	3.00	39	3278-1-1.80	■	■	■	■	■
1.90	0.95	1.90	3.00	39	3278-1-1.90	■	■	■	■	■
2.00	1.00	2.00	3.00	39	3278-1-2.00	■	■	■	■	■
2.10	1.05	2.10	3.00	39	3278-1-2.10	■	■	■	■	■
2.20	1.10	2.20	3.00	39	3278-1-2.20	■	■	■	■	■
2.30	1.15	2.30	3.00	39	3278-1-2.30	■	■	■	■	■
2.40	1.20	2.40	3.00	39	3278-1-2.40	■	■	■	■	■
2.50	1.25	2.50	3.00	39	3278-1-2.50	■	■	■	■	■
2.60	1.30	2.60	3.00	39	3278-1-2.60	■	■	■	■	■
2.70	1.35	2.70	3.00	39	3278-1-2.70	■	■	■	■	■
2.80	1.40	2.80	3.00	39	3278-1-2.80	■	■	■	■	■
2.90	1.45	2.90	3.00	39	3278-1-2.90	■	■	■	■	■

MICRO-LINE

Micro-fraises de précision

Mikropräzisionsfräser

Precision micro end mills

3278-1.5

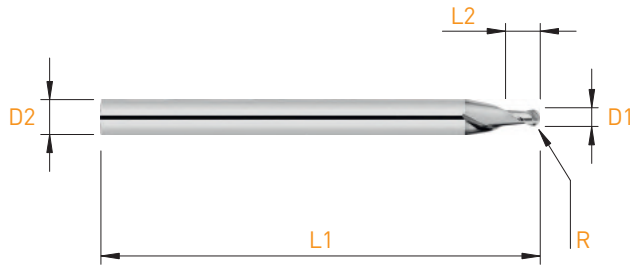

D1 +0.005 / -0.010	R	L2	D2 h4	L1	Art. N°	Z	TiAlN	STF	TiCN	DLC
0.20	0.10	0.30	3.00	39	3278-1.5-0.20	■				
0.25	0.125	0.35	3.00	39	3278-1.5-0.25	■				
0.30	0.15	0.45	3.00	39	3278-1.5-0.30	■	■	■	■	■
0.40	0.20	0.60	3.00	39	3278-1.5-0.40	■	■	■	■	■
0.50	0.25	0.75	3.00	39	3278-1.5-0.50	■	■	■	■	■
0.60	0.30	0.90	3.00	39	3278-1.5-0.60	■	■	■	■	■
0.70	0.35	1.05	3.00	39	3278-1.5-0.70	■	■	■	■	■
0.80	0.40	1.20	3.00	39	3278-1.5-0.80	■	■	■	■	■
0.85	0.40	1.30	3.00	39	3278-1.5-0.85	■	■	■	■	■
0.90	0.45	1.35	3.00	39	3278-1.5-0.90	■	■	■	■	■
1.00	0.50	1.50	3.00	39	3278-1.5-1.00	■	■	■	■	■
1.10	0.55	1.65	3.00	39	3278-1.5-1.10	■	■	■	■	■
1.15	0.55	1.75	3.00	39	3278-1.5-1.15	■	■	■	■	■
1.20	0.60	1.80	3.00	39	3278-1.5-1.20	■	■	■	■	■
1.30	0.65	1.95	3.00	39	3278-1.5-1.30	■	■	■	■	■
1.40	0.70	2.10	3.00	39	3278-1.5-1.40	■	■	■	■	■
1.50	0.75	2.25	3.00	39	3278-1.5-1.50	■	■	■	■	■
1.60	0.80	2.40	3.00	39	3278-1.5-1.60	■	■	■	■	■
1.70	0.85	2.60	3.00	39	3278-1.5-1.70	■	■	■	■	■
1.80	0.90	2.70	3.00	39	3278-1.5-1.80	■	■	■	■	■
1.90	0.95	2.90	3.00	39	3278-1.5-1.90	■	■	■	■	■
2.00	1.00	3.00	3.00	39	3278-1.5-2.00	■	■	■	■	■
2.10	1.05	3.20	3.00	39	3278-1.5-2.10	■	■	■	■	■
2.20	1.10	3.30	3.00	39	3278-1.5-2.20	■	■	■	■	■
2.30	1.15	3.50	3.00	39	3278-1.5-2.30	■	■	■	■	■
2.40	1.20	3.60	3.00	39	3278-1.5-2.40	■	■	■	■	■
2.50	1.25	3.75	3.00	39	3278-1.5-2.50	■	■	■	■	■
2.60	1.30	3.90	3.00	39	3278-1.5-2.60	■	■	■	■	■
2.70	1.35	4.00	3.00	39	3278-1.5-2.70	■	■	■	■	■
2.80	1.40	4.20	3.00	39	3278-1.5-2.80	■	■	■	■	■
2.90	1.45	4.40	3.00	39	3278-1.5-2.90	■	■	■	■	■

Micro-fraises de précision

Mikropräzisionsfräser

Precision micro end mills

3278-3

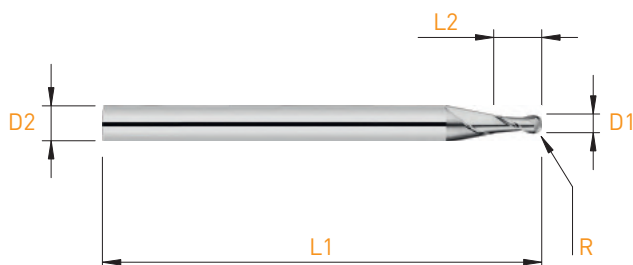

D1 +0.005 / -0.010	R	L2	D2 h4	L1	Art. N°	Z	TiAlN	STF	TiCN	DLC
0.20	0.10	0.60	3.00	39	3278-3-0.20	■				
0.30	0.15	1.00	3.00	39	3278-3-0.30	■	■	■	■	■
0.40	0.20	1.00	3.00	39	3278-3-0.40	■	■	■	■	■
0.50	0.25	1.50	3.00	39	3278-3-0.50	■	■	■	■	■
0.60	0.30	1.50	3.00	39	3278-3-0.60	■	■	■	■	■
0.70	0.35	2.00	3.00	39	3278-3-0.70	■	■	■	■	■
0.80	0.40	2.00	3.00	39	3278-3-0.80	■	■	■	■	■
0.90	0.45	2.50	3.00	39	3278-3-0.90	■	■	■	■	■
1.00	0.50	3.00	3.00	39	3278-3-1.00	■	■	■	■	■
1.20	0.60	4.00	3.00	39	3278-3-1.20	■	■	■	■	■
1.30	0.65	4.00	3.00	39	3278-3-1.30	■	■	■	■	■
1.40	0.70	4.00	3.00	39	3278-3-1.40	■	■	■	■	■
1.50	0.75	4.50	3.00	39	3278-3-1.50	■	■	■	■	■
1.55	0.775	5.00	3.00	39	3278-3-1.55	■	■	■	■	■
1.60	0.80	5.00	3.00	39	3278-3-1.60	■	■	■	■	■
1.80	0.90	5.50	3.00	39	3278-3-1.80	■	■	■	■	■
2.00	1.00	6.00	3.00	39	3278-3-2.00	■	■	■	■	■
2.10	1.05	6.50	3.00	39	3278-3-2.10	■	■	■	■	■
2.20	1.10	7.00	3.00	39	3278-3-2.20	■	■	■	■	■
2.50	1.25	7.50	3.00	39	3278-3-2.50	■	■	■	■	■
2.60	1.30	7.80	3.00	39	3278-3-2.60	■	■	■	■	■
2.70	1.35	8.10	3.00	39	3278-3-2.70	■	■	■	■	■
2.80	1.40	8.40	3.00	39	3278-3-2.80	■	■	■	■	■
2.90	1.45	8.70	3.00	39	3278-3-2.90	■	■	■	■	■

new

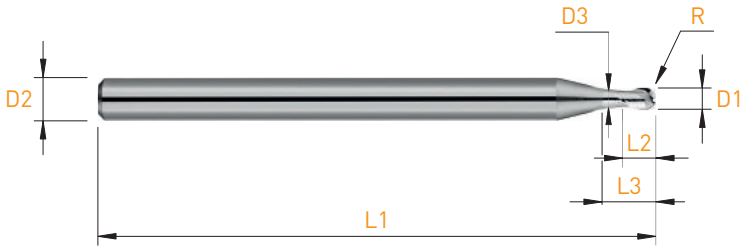

D1 +0.005 / -0.010	R	L2	L3	D3	D2 h4 Ø3.0 h5 Ø6.0	L1	Art. N°	Z	TiAlN	STF	TiCN	DLC
0.20	0.10	0.30	0.60	0.19	3.00	39	3278H-3X-0.20	■				
0.30	0.15	0.45	0.90	0.27	3.00	39	3278H-3X-0.30	■	■	■	■	■
0.40	0.20	0.60	1.20	0.37	3.00	39	3278H-3X-0.40	■	■	■	■	■
0.50	0.25	0.75	1.50	0.45	3.00	39	3278H-3X-0.50	■	■	■	■	■
0.60	0.30	0.90	1.80	0.55	3.00	39	3278H-3X-0.60	■	■	■	■	■
0.70	0.35	1.05	2.10	0.65	3.00	39	3278H-3X-0.70	■	■	■	■	■
0.80	0.40	1.20	2.40	0.75	3.00	39	3278H-3X-0.80	■	■	■	■	■
0.90	0.45	1.35	2.70	0.85	3.00	39	3278H-3X-0.90	■	■	■	■	■
1.00	0.50	1.50	3.00	0.95	3.00	39	3278H-3X-1.00	■	■	■	■	■
1.10	0.55	1.65	3.30	1.05	3.00	39	3278H-3X-1.10	■	■	■	■	■
1.20	0.60	1.80	3.60	1.15	3.00	39	3278H-3X-1.20	■	■	■	■	■
1.30	0.65	1.95	3.90	1.25	3.00	39	3278H-3X-1.30	■	■	■	■	■
1.40	0.70	2.10	4.20	1.35	3.00	39	3278H-3X-1.40	■	■	■	■	■
1.50	0.75	2.25	4.50	1.45	3.00	39	3278H-3X-1.50	■	■	■	■	■
1.60	0.80	2.40	4.80	1.55	3.00	39	3278H-3X-1.60	■	■	■	■	■
1.70	0.85	2.55	5.10	1.65	3.00	39	3278H-3X-1.70	■	■	■	■	■
1.80	0.90	2.70	5.40	1.75	3.00	39	3278H-3X-1.80	■	■	■	■	■
1.90	0.95	2.85	5.70	1.85	3.00	39	3278H-3X-1.90	■	■	■	■	■
2.00	1.00	3.00	6.00	1.95	6.00	50	3278H-3X-2.00	■	■	■	■	■
2.10	1.05	3.15	6.30	2.05	6.00	50	3278H-3X-2.10	■	■	■	■	■
2.20	1.10	3.30	6.60	2.15	6.00	50	3278H-3X-2.20	■	■	■	■	■
2.30	1.15	3.45	6.90	2.25	6.00	50	3278H-3X-2.30	■	■	■	■	■
2.40	1.20	3.60	7.20	2.35	6.00	50	3278H-3X-2.40	■	■	■	■	■
2.50	1.25	3.75	7.50	2.45	6.00	50	3278H-3X-2.50	■	■	■	■	■
3.00	1.50	4.50	9.00	2.95	6.00	50	3278H-3X-3.00	■	■	■	■	■

Micro-fraises de précision

Mikropräzisionsfräser

Precision micro end mills

3278H-6X

new



D1 +0.005 / -0.010	R	L2	L3	D3	D2 h4 Ø3.0 h5 Ø6.0	L1	Art. N°	Z	TiAlN	STF	TiCN	DLC
0.30	0.15	0.45	1.80	0.27	3.00	39	3278H-6X-0.30	■	■	■	■	■
0.40	0.20	0.60	2.40	0.37	3.00	39	3278H-6X-0.40	■	■	■	■	■
0.50	0.25	0.75	3.00	0.45	3.00	39	3278H-6X-0.50	■	■	■	■	■
0.60	0.30	0.90	3.60	0.55	3.00	39	3278H-6X-0.60	■	■	■	■	■
0.70	0.35	1.05	4.20	0.65	3.00	39	3278H-6X-0.70	■	■	■	■	■
0.80	0.40	1.20	4.80	0.75	3.00	39	3278H-6X-0.80	■	■	■	■	■
0.90	0.45	1.35	5.40	0.85	3.00	39	3278H-6X-0.90	■	■	■	■	■
1.00	0.50	1.50	6.00	0.95	3.00	39	3278H-6X-1.00	■	■	■	■	■
1.10	0.55	1.65	6.60	1.05	3.00	39	3278H-6X-1.10	■	■	■	■	■
1.20	0.60	1.80	7.20	1.15	3.00	39	3278H-6X-1.20	■	■	■	■	■
1.30	0.65	1.95	7.80	1.25	3.00	39	3278H-6X-1.30	■	■	■	■	■
1.40	0.70	2.10	8.40	1.35	3.00	39	3278H-6X-1.40	■	■	■	■	■
1.50	0.75	2.25	9.00	1.45	3.00	39	3278H-6X-1.50	■	■	■	■	■
1.60	0.80	2.40	9.60	1.55	3.00	39	3278H-6X-1.60	■	■	■	■	■
1.70	0.85	2.55	10.20	1.65	3.00	39	3278H-6X-1.70	■	■	■	■	■
1.80	0.90	2.70	10.80	1.75	3.00	39	3278H-6X-1.80	■	■	■	■	■
1.90	0.95	2.85	11.40	1.85	3.00	39	3278H-6X-1.90	■	■	■	■	■
2.00	1.00	3.00	12.00	1.95	6.00	50	3278H-6X-2.00	■	■	■	■	■
2.10	1.05	3.15	12.60	2.05	6.00	50	3278H-6X-2.10	■	■	■	■	■
2.20	1.10	3.30	13.20	2.15	6.00	50	3278H-6X-2.20	■	■	■	■	■
2.30	1.15	3.45	13.80	2.25	6.00	50	3278H-6X-2.30	■	■	■	■	■
2.40	1.20	3.60	14.40	2.35	6.00	50	3278H-6X-2.40	■	■	■	■	■
2.50	1.25	3.75	15.00	2.45	6.00	50	3278H-6X-2.50	■	■	■	■	■
3.00	1.50	4.50	18.00	2.95	6.00	50	3278H-6X-3.00	■	■	■	■	■

MICRO-LINE

Micro-fraises de précision

Mikropräzisionsfräser

Precision micro end mills

3278H-9X

new

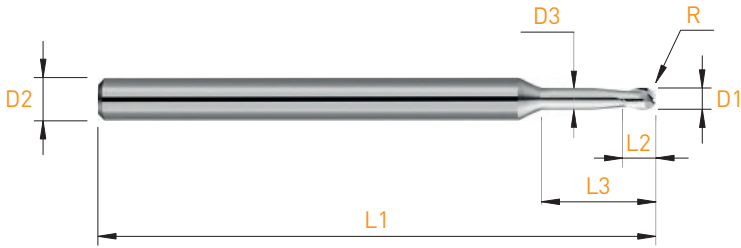

D1 +0.005 / -0.010	R	L2	L3	D3	D2 h4 Ø3.0 h5 Ø6.0	L1	Art. N°	Z	TiAlN	STF	TiCN	DLC
0.40	0.20	0.60	3.60	0.37	3.00	39	3278H-9X-0.40	■	■	■	■	■
0.50	0.25	0.75	4.50	0.45	3.00	39	3278H-9X-0.50	■	■	■	■	■
0.60	0.30	0.90	5.40	0.55	3.00	39	3278H-9X-0.60	■	■	■	■	■
0.70	0.35	1.05	6.30	0.65	3.00	39	3278H-9X-0.70	■	■	■	■	■
0.80	0.40	1.20	7.20	0.75	3.00	39	3278H-9X-0.80	■	■	■	■	■
0.90	0.45	1.35	8.10	0.85	3.00	39	3278H-9X-0.90	■	■	■	■	■
1.00	0.50	1.50	9.00	0.95	3.00	39	3278H-9X-1.00	■	■	■	■	■
1.10	0.55	1.65	9.90	1.05	3.00	39	3278H-9X-1.10	■	■	■	■	■
1.20	0.60	1.80	10.80	1.15	3.00	39	3278H-9X-1.20	■	■	■	■	■
1.30	0.65	1.95	11.70	1.25	3.00	39	3278H-9X-1.30	■	■	■	■	■
1.40	0.70	2.10	12.60	1.35	3.00	39	3278H-9X-1.40	■	■	■	■	■
1.50	0.75	2.25	13.50	1.45	3.00	39	3278H-9X-1.50	■	■	■	■	■
1.60	0.80	2.40	14.40	1.55	3.00	39	3278H-9X-1.60	■	■	■	■	■
1.70	0.85	2.55	15.30	1.65	3.00	39	3278H-9X-1.70	■	■	■	■	■
1.80	0.90	2.70	16.20	1.75	3.00	39	3278H-9X-1.80	■	■	■	■	■
1.90	0.95	2.85	17.10	1.85	3.00	39	3278H-9X-1.90	■	■	■	■	■
2.00	1.00	3.00	18.00	1.95	6.00	50	3278H-9X-2.00	■	■	■	■	■
2.10	1.05	3.15	18.90	2.05	6.00	50	3278H-9X-2.10	■	■	■	■	■
2.20	1.10	3.30	19.80	2.15	6.00	50	3278H-9X-2.20	■	■	■	■	■
2.30	1.15	3.45	20.70	2.25	6.00	50	3278H-9X-2.30	■	■	■	■	■
2.40	1.20	3.60	21.60	2.35	6.00	50	3278H-9X-2.40	■	■	■	■	■
2.50	1.25	3.75	22.50	2.45	6.00	50	3278H-9X-2.50	■	■	■	■	■
3.00	1.50	4.50	27.00	2.95	6.00	50	3278H-9X-3.00	■	■	■	■	■









Fraises en bout





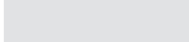

Schaftfräser

End mills

Paramètres de coupe indicatif
Empfohlene Schnittwerte
Standard machining data

14.53

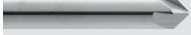
	Fraises en bout avec angle vif Schaftfräser mit scharfkantigen Ecken End mills with sharp corners					
	Z	λ	D1	D2	Type	page
	Z=3	Div.	Ø1.00 - 8.00	Ø3/6/8	E-DHP4300-1.5	14.57
	Z=4	26° / 33°	Ø10.00	Ø10 h6	E-DHP4400-1.5	
	Z=3	Div.	Ø1.00 - 8.00	Ø3/6/8	E-DHP4300-2.5	
	Z=4	26° / 33°	Ø10.00	Ø10h6	E-DHP4400-2.5	
	Z=1	23°	Ø1.00 - 6.00	Ø6h5	3123-2	14.58 new
			Ø1.00 - 6.00	Ø6h5	3123-4	14.59 new
	Z=2	60°	Ø0.50 - 6.00	Ø3/6/8	3260MV	14.60 new
		90°	Ø0.30 - 6.00	Ø3/6/8	3290MV	14.61 new
		120°	Ø0.50 - 6.00	Ø3/6/8	32120MV	14.62 new
	Z=2	30°	Ø1.00 - 6.00	Ø6 h5	3230	14.63
			Ø3.00 - 6.00	Ø6 h5	3230-1.5	14.64 new
			Ø3.00 - 6.00	Ø6 h5	3230-3	14.65 new
			Ø2.00 - 6.00	D1 = D2	3231	14.66
			Ø3.00 - 6.00	Ø6 h5	3239T-2.5X	14.67 new
			Ø3.00 - 6.00	Ø6 h5	3239T-4X	14.68 new
	Z=3	30°	Ø1.00 - 6.00	Ø6 h6	3330-S	14.69
			Ø3.00-12.00	D1 = D2	3330	14.70
			Ø3.00 - 6.00	Ø6 h5	3330-4	14.71 new
			Ø2.00 - 6.00	D1 = D2	3331	14.72
			Ø1.50 - 6.00	Ø6 h5	3336-HA	14.73
			Ø1.50 - 6.00	Ø6 h5	3337-HA	14.73
			Ø2.00 - 6.00	D1 = D2	3341	14.74
			Ø0.50 - 6.00	Ø6 h6	3345-S	14.75 new
	Z=4	30°	Ø3.00 - 6.00	D1 = D2	3430	14.78
			Ø2.00 - 6.00	D1 = D2	3431	14.79
			Ø2.00 - 6.00	D1 = D2	3441	14.80
			Ø0.50 - 6.00	Ø6 h6	3445-S	14.81
			Ø1.00 - 6.00	Ø6 h5	3450	14.82 new
			Ø1.00 - 6.00	Ø6 h5	DHP3436	14.83
	Z=4	30°	Ø3.00 - 6.00	Ø6 h5	3439T-2.5X	14.84 new
			Ø3.00 - 6.00	Ø6 h5	3439T-4X	14.85 new
			Ø1.00 - 6.00	Ø6 h5	3545	14.86 new
			Ø1.00 - 6.00	Ø6 h5	35645	14.87 new
	Z=8	10°	Ø6.00	Ø6 h5	3810	14.88 new

 	Z	λ	D1	D2	Type	page	
	    	Z=2	30°	Ø2.00 - 6.00	D1 = D2	3238	14.89
Z=3		30°	Ø2.00 - 6.00	D1 = D2	3338	14.90	
Z=3				Ø0.30 - 3.50	Ø6 h5	701S3371-1	
				Ø0.30 - 3.50	Ø6 h5	701S3371-2	14.91
				Ø0.30 - 3.00	Ø6 h5	701S3371-3	
Z=3		30°	Ø8.00-12.00	Ø6h6	3383	14.93	
Z=10		30°	Ø16.3 / 20.30	Ø10h6	3831 / 3833	14.94	
Z=3		0°	Ø0.50 - 3.00	Ø3h4	3611	14.95	new
Z=3		0°	Ø0.50 - 3.00	Ø3h4	3911	14.96	
Z=4		0°	Ø3.00-8.00	Ø3 h4 Ø6 h5 Ø8 h6	3901	14.97	

Fraises ébauches

Schrupfräser

Roughing mills

Paramètres de coupe indicatifs

Empfohlene Schnittwerte

Standard machining data

Matière Werkstoff Material	VC	1.0 - 2.0	2.0 - 4.0	4.0 - 6.0	6.0 - 10.0	Z	TAIN	STF
	(m/min)	fz (mm)	fz (mm)	fz (mm)	fz (mm)			
Acier de décolletage Automatenstahl Free-cutting steel (P)	100 - 140	0.010 - 0.015	0.015 - 0.030	0.030 - 0.040	0.040 - 0.060	-	***	***
Acier Stahl < 600 N/mm ² (P)	90 - 140	0.010 - 0.015	0.015 - 0.030	0.030 - 0.040	0.040 - 0.060	-	***	***
Acier Stahl < 800 N/mm ² (P)	90 - 140	0.010 - 0.015	0.015 - 0.030	0.030 - 0.040	0.040 - 0.060	-	***	***
Acier Stahl > 800 N/mm ² (P)	80 - 120	0.010 - 0.015	0.015 - 0.030	0.030 - 0.040	0.040 - 0.060	-	***	***
Acier trempé Gehärteter Stahl -55HRC (H)	120 - 170	0.005 - 0.008	0.008 - 0.015	0.015 - 0.020	0.020 - 0.035	-	***	***
Acier trempé Gehärteter Stahl +55HRC (H)	110 - 150	0.005 - 0.008	0.008 - 0.015	0.015 - 0.020	0.020 - 0.035	-	***	***
Inox Rostfreistahl Stainless steel (M)	50 - 90	0.004 - 0.008	0.008 - 0.012	0.012 - 0.020	0.020 - 0.040	-	***	***
Aluminium (N)	250 - 350	0.008 - 0.015	0.015 - 0.030	0.030 - 0.040	0.040 - 0.065	-	***	**
Cuivre, laiton, bronze Kupfer, Messing, Bronze Copper, brass, bronze (N)	130 - 240	0.005 - 0.010	0.010 - 0.020	0.020 - 0.030	0.030 - 0.050	-	***	**
Matière synthétique Synthetisches Material Synthetic material (N)	150 - 300	0.020 - 0.030	0.030 - 0.050	0.050 - 0.080	0.080 - 0.150	-	***	**
Métaux précieux Edelmetalle Precious metals (N)	120 - 150	0.005 - 0.010	0.010 - 0.020	0.020 - 0.030	0.030 - 0.050	-	***	**
Titane Titan Titanium (S)	50 - 100	0.010 - 0.015	0.015 - 0.020	0.020 - 0.030	0.030 - 0.050	-	***	***
Alliage de nickel Nickel-Legierung Nickel alloy (S)	40 - 60	0.005 - 0.007	0.007-0.012	0.012 - 0.020	0.020 - 0.030	-	***	***
Matière exotique Exotisches material Exotic material (O)	15 - 25	0.005 - 0.010	0.010 - 0.020	0.020 - 0.030	0.030 - 0.050	-	***	***

Avec revêtement, augmenter les valeurs de 20-30%

Mit Beschichtung, Daten um 20-30% erhöhen

With coating, increase data by 20-30%

* Bien / Gut / Good

** Très bien / Sehr Gut / Very good

*** Excellent / Ausgezeichnet / Excellent

Fraises en bout

Schafffräser

End mills

Paramètres de coupe indicatifs

Empfohlene Schnittwerte

Standard machining data

Matière Werkstoff Material	VC	0.50 - 2.0	2.0 - 4.0	4.0 - 6.0	6.0 - 8.0	8.0 - 12.0	Z	TAIN	STF	DLC
	(m/min)	fz (mm)	fz (mm)	fz (mm)	fz (mm)	fz (mm)				
Acier de décolletage Automatenstahl Free-cutting steel	P 80 - 130	0.004-0.015	0.015 - 0.025	0.025 - 0.035	0.035 - 0.050	0.050 - 0.080	-	***	***	-
Acier Stahl Steel < 600 N/mm ²	P 70 - 100	0.004-0.015	0.015 - 0.025	0.025 - 0.035	0.035 - 0.050	0.050 - 0.080	-	***	***	-
Acier Stahl Steel < 800 N/mm ²	P 70 - 100	0.004-0.015	0.015 - 0.025	0.025 - 0.035	0.035 - 0.050	0.050 - 0.080	-	***	***	-
Acier Stahl Steel > 800 N/mm ²	P 50 - 80	0.004-0.015	0.015 - 0.025	0.025 - 0.035	0.035 - 0.050	0.050 - 0.080	-	***	***	-
Acier trempé Gehärteter Stahl -55HRC Hardened steel	H 60 - 90	0.002 - 0.008	0.008 - 0.015	0.012 - 0.020	0.020 - 0.025	0.025 - 0.030	-	***	***	-
Acier trempé Gehärteter Stahl +55HRC Hardened steel	H 40 - 70	0.002 - 0.008	0.008 - 0.015	0.012 - 0.020	0.020 - 0.025	0.020 - 0.030	-	***	***	-
Inox Rostfreistahl Stainless steel	M 40 - 80	0.003 - 0.008	0.008 - 0.015	0.015 - 0.020	0.020 - 0.030	0.030 - 0.050	-	***	***	-
Aluminium	N 230 - 320	0.003 - 0.010	0.010 - 0.025	0.025 - 0.030	0.030 - 0.050	0.050 - 0.080	**	*	**	***
Cuivre, laiton, bronze Kupfer, Messing, Bronze Copper, brass, bronze	N 100 - 190	0.003 - 0.010	0.010 - 0.020	0.020 - 0.030	0.030 - 0.040	0.040 - 0.070	**	*	**	***
Matière synthétique Synthetisches Material Synthetic material	N 250 - 500	0.005 - 0.030	0.030 - 0.050	0.050 - 0.080	0.080 - 0.100	0.100 - 0.200	***	-	**	***
Métaux précieux Edelmetalle Precious metals	N 90 - 150	0.003 - 0.015	0.015 - 0.025	0.025 - 0.030	0.030 - 0.050	0.050 - 0.080	***	*	**	***
Titane Titan Titanium	S 30 - 70	0.004 - 0.010	0.010 - 0.017	0.017-0.025	0.025 - 0.035	0.035 - 0.050	-	**	***	-
Alliage de nickel Nickel-Legierung Nickel alloy	S 30 - 60	0.003 - 0.008	0.008 - 0.015	0.015 - 0.020	0.020 - 0.025	0.025 - 0.040	-	***	***	-
Matière exotique Exotisches material Exotic material	O 15 - 25	0.002 - 0.008	0.008 - 0.020	0.020 - 0.030	0.030 - 0.040	0.040 - 0.050	-	***	***	**

Avec revêtement, augmenter les valeurs de 20-30%

Mit Beschichtung, Daten um 20-30% erhöhen

With coating, increase data by 20-30%

* Bien / Gut / Good

** Très bien / Sehr Gut / Very good

*** Excellent / Ausgezeichnet / Excellent

Outils WM 701S

Werkzeuge WM 701S

Tools WM 701S

Paramètres de coupe indicatifs

Empfohlene Schnittwerte

Standard machining data

Matière Werkstoff Material		VC	Z	TiAlN	STF	DLC
		(m/min)				
Acier de décolletage Automatenstahl Free-cutting steel	P	120 - 180	-	***	***	-
Acier Stahl Steel	< 600 N/mm ² P	100 - 150	-	***	***	-
Acier Stahl Steel	< 800 N/mm ² P	100 - 130	-	***	***	-
Acier Stahl Steel	> 800 N/mm ² P	80 - 100	-	***	***	-
Acier trempé Gehärteter Stahl -55HRC Hardened steel	H	-	-	***	***	-
Acier trempé Gehärteter Stahl +55HRC Hardened steel	H	-	-	***	***	-
Inox Rostfreistahl Stainless steel	M	60 - 90	-	***	***	-
Aluminium	N	250 - 400	**	***	***	***
Cuivre, laiton, bronze Kupfer, Messing, Bronze Copper, brass, bronze	N	150 - 200	***	**	**	***
Matière synthétique Synthetisches Material Synthetic material	N	100 - 150	***	**	**	***
Métaux précieux Edelmetalle Precious metals	N	140 - 200	***	**	**	***
Titane Titan Titanium	S	40 - 70	-	***	***	-
Alliage de nickel Nickel-Legierung Nickel alloy	S	30 - 60	-	***	***	-
Matière exotique Exotisches material Exotic material	O	30 - 60	-	***	***	***

Avec revêtement, augmenter les valeurs de 20-30%

Mit Beschichtung, Daten um 20-30% erhöhen

With coating, increase data by 20-30%

* Bien / Gut / Good

** Très bien / Sehr Gut / Very good

*** Excellent / Ausgezeichnet / Excellent

Fraises à angler

Kegelsenker

Chamfering tools

Paramètres de coupe indicatifs

Empfohlene Schnittwerte

Standard machining data

Matière Werkstoff Material		VC	Z	TiAlN	STF
		(m/min)			
Acier de décolletage Automatenstahl Free-cutting steel	P	80 - 130	★	★★★	★★★
Acier Stahl Steel	< 600 N/mm ² P	70 - 100	★	★★★	★★★
Acier Stahl Steel	< 800 N/mm ² P	70 - 100	★	★★★	★★★
Acier Stahl Steel	> 800 N/mm ² P	50 - 80	★	★★★	★★★
Acier trempé Gehärteter Stahl Hardened steel	-55HRC H	60 - 90	-	★★	★★★
Acier trempé Gehärteter Stahl Hardened steel	+55HRC H	40 - 70	-	★★	★★★
Inox Rostfreistahl Stainless steel	M	50 - 100	★	★★★	★★★
Aluminium	N	200 - 300	★★★	★★	★★★
Cuivre, laiton, bronze Kupfer, Messing, Bronze Copper, brass, bronze	N	100 - 200	★★★	★★	★★★
Matière synthétique Synthetisches Material Synthetic material	N	200 - 500	★★★	★★	★★
Métaux précieux Edelmetalle Precious metals	N	90 - 140	★★★	★★	★★★
Titane Titan Titanium	S	30 - 80	-	★★★	★★★
Alliage de nickel Nickel-Legierung Nickel alloy	S	30 - 60	-	★★★	★★★
Matière exotique Exotisches material Exotic material	O	20 - 30	-	★★★	★★★

Avec revêtement, augmenter les valeurs de 20-30%
Mit Beschichtung, Daten um 20-30% erhöhen
With coating, increase data by 20-30%

* Bien / Gut / Good
** Très bien / Sehr Gut / Very good
*** Excellent / Ausgezeichnet / Excellent

Fraises ébauches

Schrupfräser

Roughing mills

E-DHP3300 / 3400

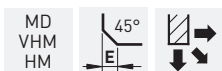
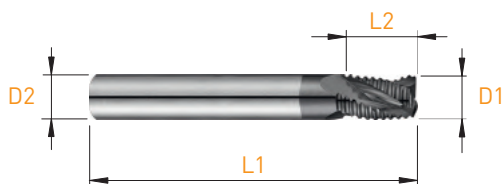

	Z	E	λ	D1 h10	L2	D2 h6	L1	Art. N°	Z	TiAIN	STF
	3	0.05	26°/30°	1.00	1.50	3.00	39	E-DHP3300-1.5-1.00	■	■	■
	3	0.10	26°/30°	1.50	2.25	3.00	39	E-DHP3300-1.5-1.50	■	■	■
	3	0.20	26°/30°	2.00	3.00	3.00	39	E-DHP3300-1.5-2.00	■	■	■
	3	0.20	26°/33°	2.50	3.75	6.00	50	E-DHP3300-1.5-2.50	■	■	■
	3	0.20	26°/33°	3.00	4.25	6.00	50	E-DHP3300-1.5-3.00	■	■	■
	3	0.30	26°/33°	4.00	6.00	6.00	50	E-DHP3300-1.5-4.00	■	■	■
	3	0.30	26°/33°	5.00	7.50	6.00	50	E-DHP3300-1.5-5.00	■	■	■
	3	0.40	26°/33°	6.00	9.00	6.00	50	E-DHP3300-1.5-6.00	■	■	■
	3	0.50	26°/33°	8.00	12.00	8.00	64	E-DHP3300-1.5-8.00	■	■	■
	4	0.50	26°/33°	10.00	15.00	10.00	73	E-DHP3400-1.5-10.00	■	■	■

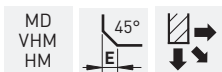
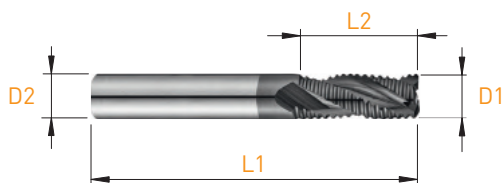

	Z	E	λ	D1 h10	L2	D2 h6	L1	Art. N°	Z	TiAIN	STF
	3	0.05	26°/30°	1.00	2.50	3.00	39	E-DHP3300-2.5-1.00	■	■	■
	3	0.10	26°/30°	1.50	3.75	3.00	39	E-DHP3300-2.5-1.50	■	■	■
	3	0.20	26°/30°	2.00	5.00	3.00	39	E-DHP3300-2.5-2.00	■	■	■
	3	0.20	26°/33°	2.50	6.25	6.00	58	E-DHP3300-2.5-2.50	■	■	■
	3	0.20	26°/33°	3.00	7.50	6.00	58	E-DHP3300-2.5-3.00	■	■	■
	3	0.30	26°/33°	4.00	10.00	6.00	58	E-DHP3300-2.5-4.00	■	■	■
	3	0.30	26°/33°	5.00	12.50	6.00	58	E-DHP3300-2.5-5.00	■	■	■
	3	0.40	26°/33°	6.00	15.00	6.00	58	E-DHP3300-2.5-6.00	■	■	■
	3	0.50	26°/33°	8.00	20.00	8.00	64	E-DHP3300-2.5-8.00	■	■	■
	4	0.50	26°/33°	10.00	25.00	10.00	73	E-DHP3400-2.5-10.00	■	■	■

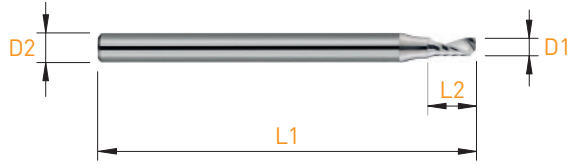

MD VHM HM	λ 23°	Sharp Corner		2xD1	Z=1
-----------------	---------------	-----------------	--	------	-----

D1 h10	L2	D2 h5	L1	Art. N°	Z	TiAIN	STF	DLC
1.00	2.00	6.00	50	3123-2-1.0	■	■	■	■
2.00	4.00	6.00	50	3123-2-2.0	■	■	■	■
3.00	6.00	6.00	50	3123-2-3.0	■	■	■	■
4.00	8.00	6.00	50	3123-2-4.0	■	■	■	■
5.00	10.00	6.00	50	3123-2-5.0	■	■	■	■
6.00	12.00	6.00	50	3123-2-6.0	■	■	■	■

Fraises en bout de finition

Schlicht Schafffräser

Finishing end mills

3123-4

new

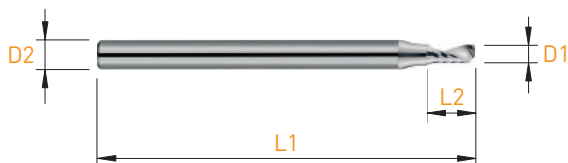

MD VHM HM	λ 23°	Sharp Corner		4xD1	Z=1
-----------------	---------------	-----------------	--	------	-----

D1 h10	L2	D2 h5	L1	Art. N°	Z	TiAlN	STF	DLC
1.00	4.00	6.00	50	3123-4-1.0	■	■	■	■
2.00	8.00	6.00	50	3123-4-2.0	■	■	■	■
3.00	12.00	6.00	50	3123-4-3.0	■	■	■	■
4.00	16.00	6.00	50	3123-4-4.0	■	■	■	■
5.00	20.00	6.00	50	3123-4-5.0	■	■	■	■
6.00	24.00	6.00	50	3123-4-6.0	■	■	■	■

new

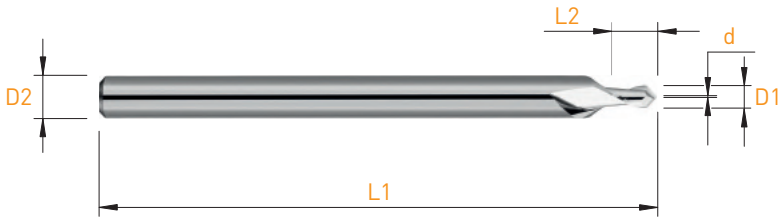

D1 h10	d	L2	D2 Ø3h4 Ø4h5 Ø8h6	L1	Art. N°	Z	TiAlN	STF
0.50	0.05	1.00	3.00	39	3260MV-0.5	■	■	■
1.00	0.10	2.00	3.00	39	3260MV-1.0	■	■	■
1.50	0.15	3.00	3.00	39	3260MV-1.5	■	■	■
2.00	0.20	4.00	3.00	39	3260MV-2.0	■	■	■
2.50	0.25	5.00	3.00	39	3260MV-2.5	■	■	■
3.00	0.30	6.00	6.00	50	3260MV-3.0	■	■	■
4.00	0.40	8.00	6.00	50	3260MV-4.0	■	■	■
6.00	0.60	12.00	8.00	63	3260MV-6.0	■	■	■

Fraises Multi-V

Multi-V Fräser

End mills Multi-V

3290MV

new

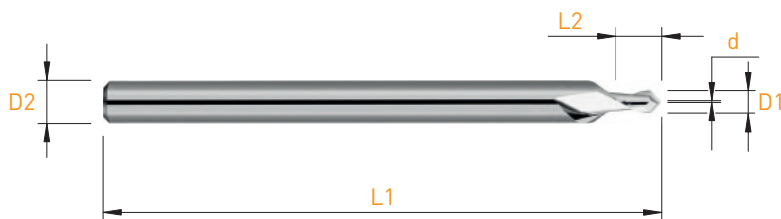

D1 h10	d	L2	D2 Ø3h4 Ø6h5 Ø8h6	L1	Art. N°	Z	TiAlN	STF
0.30	0.03	0.60	3.00	39	3290MV-0.3	■	■	■
0.40	0.04	0.80	3.00	39	3290MV-0.4	■	■	■
0.50	0.05	1.00	3.00	39	3290MV-0.5	■	■	■
0.60	0.06	1.20	3.00	39	3290MV-0.6	■	■	■
0.70	0.07	1.40	3.00	39	3290MV-0.7	■	■	■
0.80	0.08	1.60	3.00	39	3290MV-0.8	■	■	■
0.90	0.09	1.80	3.00	39	3290MV-0.9	■	■	■
1.00	0.10	2.00	3.00	39	3290MV-1.0	■	■	■
1.10	0.11	2.20	3.00	39	3290MV-1.1	■	■	■
1.20	0.12	2.40	3.00	39	3290MV-1.2	■	■	■
1.30	0.13	2.60	3.00	39	3290MV-1.3	■	■	■
1.40	0.14	2.80	3.00	39	3290MV-1.4	■	■	■
1.50	0.15	3.00	3.00	39	3290MV-1.5	■	■	■
1.60	0.16	3.20	3.00	39	3290MV-1.6	■	■	■
1.70	0.17	3.40	3.00	39	3290MV-1.7	■	■	■
1.80	0.18	3.60	3.00	39	3290MV-1.8	■	■	■
1.90	0.19	3.80	3.00	39	3290MV-1.9	■	■	■
2.00	0.20	4.00	3.00	39	3290MV-2.0	■	■	■
2.50	0.25	5.00	3.00	39	3290MV-2.5	■	■	■
3.00	0.30	6.00	6.00	50	3290MV-3.0	■	■	■
4.00	0.40	8.00	6.00	50	3290MV-4.0	■	■	■
6.00	0.60	12.00	8.00	63	3290MV-6.0	■	■	■

new

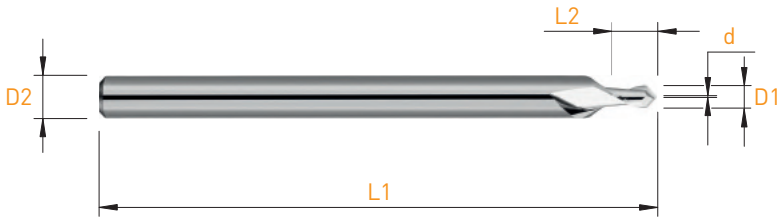

D1 h10	d	L2	D2 Ø3h4 Ø4h5 Ø8h6	L1	Art. N°	Z	TiAlN	STF
0.50	0.05	1.00	3.00	39	32120MV-0.5	■	■	■
1.00	0.10	2.00	3.00	39	32120MV-1.0	■	■	■
1.50	0.15	3.00	3.00	39	32120MV-1.5	■	■	■
2.00	0.20	4.00	3.00	39	32120MV-2.0	■	■	■
2.50	0.25	5.00	3.00	39	32120MV-2.5	■	■	■
3.00	0.30	6.00	6.00	50	32120MV-3.0	■	■	■
4.00	0.40	8.00	6.00	50	32120MV-4.0	■	■	■
6.00	0.60	12.00	8.00	63	32120MV-6.0	■	■	■

Fraises en bout de finition

Schlicht Schafffräser

Finishing end mills

3230

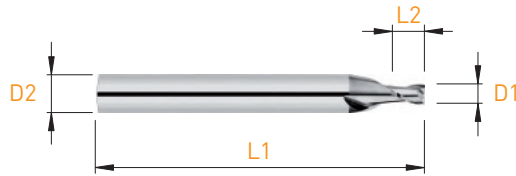

D1 _{h10}	L2	D2 _{h5}	L1	Art. N°	Z	TiAlN	STF
1.00	1.00	6.00	50	3230-1.0	■	■	■
1.50	1.50	6.00	50	3230-1.5	■	■	■
2.00	2.00	6.00	50	3230-2.0	■	■	■
2.50	2.50	6.00	50	3230-2.5	■	■	■
3.00	3.00	6.00	50	3230-3.0	■	■	■
4.00	4.00	6.00	50	3230-4.0	■	■	■
5.00	5.00	6.00	50	3230-5.0	■	■	■
6.00	6.00	6.00	50	3230-6.0	■	■	■

new

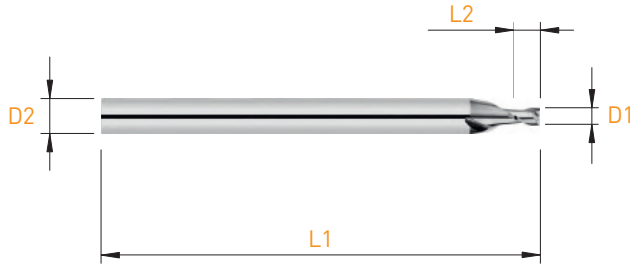

MD VHM HM	λ 30°	Sharp Corner		1.5xD1	Z=2	
-----------------	---------------	-----------------	--	--------	-----	--

D1 h10	L2	D2 h5	L1	Art. N°	Z	TiAlN	STF
3.00	4.50	6.00	50	3230-1.5-3.0	■	■	■
3.50	5.00	6.00	50	3230-1.5-3.5	■	■	■
4.00	6.00	6.00	50	3230-1.5-4.0	■	■	■
4.50	7.00	6.00	50	3230-1.5-4.5	■	■	■
5.00	8.00	6.00	50	3230-1.5-5.0	■	■	■
6.00	9.00	6.00	50	3230-1.5-6.0	■	■	■

Fraises en bout de finition

Schlicht Schafffräser

Finishing end mills

3230-3

new

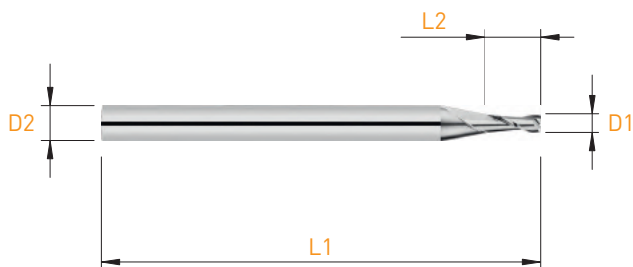

D1 h10	L2	D2 h5	L1	Art. N°	Z	TIAIN	STF
3.00	9.00	6.00	50	3230-3-3.0	■	■	■
3.50	10.00	6.00	50	3230-3-3.5	■	■	■
4.00	12.00	6.00	50	3230-3-4.0	■	■	■
4.50	13.00	6.00	50	3230-3-4.5	■	■	■
5.00	15.00	6.00	50	3230-3-5.0	■	■	■
6.00	18.00	6.00	50	3230-3-6.0	■	■	■

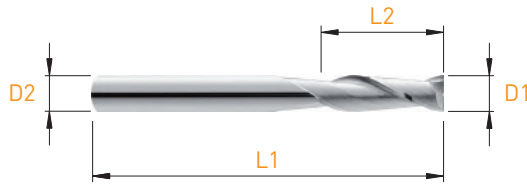

D1 e9	L2	D2 h5	L1	Art. N°	Z	TiAlN	STF
2.00	8.00	2.00	32	3231-2.0	■	■	■
2.50	8.00	2.50	32	3231-2.5	■	■	■
3.00	12.00	3.00	32	3231-3.0	■	■	■
3.50	12.00	3.50	32	3231-3.5	■	■	■
4.00	12.00	4.00	40	3231-4.0	■	■	■
4.50	14.00	4.50	50	3231-4.5	■	■	■
5.00	14.00	5.00	50	3231-5.0	■	■	■
6.00	16.00	6.00	50	3231-6.0	■	■	■

Fraises en bout de finition

Schlicht Schafffräser

Finishing end mills

3239T-2.5X

new

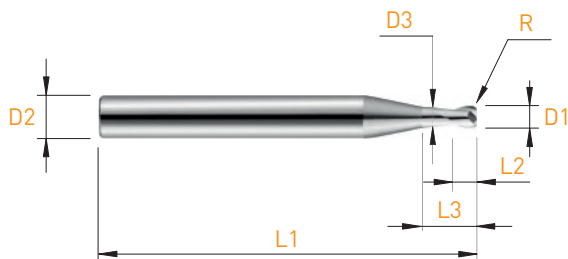

D1 h10	R +/- 0.02	L2	L3	D3	D2 h5	L1	Art. N°	Z	TiAlN	STF
3.00	0.50	3.00	7.50	2.95	6.00	57	3239T-2.5X-3.0	■	■	■
3.50	0.50	3.50	8.75	3.45	6.00	57	3239T-2.5X-3.5	■	■	■
4.00	0.50	4.00	10.00	3.95	6.00	57	3239T-2.5X-4.0	■	■	■
4.50	0.50	4.50	11.25	4.45	6.00	57	3239T-2.5X-4.5	■	■	■
5.00	0.50	5.00	12.50	4.95	6.00	57	3239T-2.5X-5.0	■	■	■
5.50	0.50	5.50	13.75	5.45	6.00	57	3239T-2.5X-5.5	■	■	■
6.00	0.50	6.00	15.00	5.95	6.00	57	3239T-2.5X-6.0	■	■	■

new

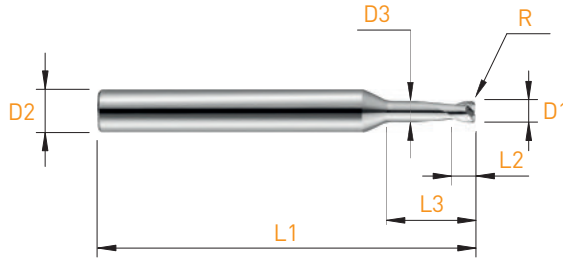

D1 h10	R +/- 0.02	L2	L3	D3	D2 h5	L1	Art. N°	Z	TiAlN	STF
3.00	0.50	3.00	12.00	2.95	6.00	57	3239T-4X-3.0	■	■	■
3.50	0.50	3.50	14.00	3.45	6.00	57	3239T-4X-3.5	■	■	■
4.00	0.50	4.00	16.00	3.95	6.00	57	3239T-4X-4.0	■	■	■
4.50	0.50	4.50	18.00	4.45	6.00	57	3239T-4X-4.5	■	■	■
5.00	0.50	5.00	20.00	4.95	6.00	57	3239T-4X-5.0	■	■	■
5.50	0.50	5.50	22.00	5.45	6.00	57	3239T-4X-5.5	■	■	■
6.00	0.50	6.00	24.00	5.95	6.00	57	3239T-4X-6.0	■	■	■

Fraises en bout de finition

Schlicht Schafffräser

Finishing end mills

3330-S



D1 h10	L2	D2 h6	L1	Art. N°	Z	TiAlN	STF
1.00	3.00	6.00	40	3330-S-1.0	■	■	■
1.50	3.00	6.00	40	3330-S-1.5	■	■	■
2.00	3.00	6.00	40	3330-S-2.0	■	■	■
2.50	3.00	6.00	40	3330-S-2.5	■	■	■
3.00	4.00	6.00	40	3330-S-3.0	■	■	■
3.50	4.00	6.00	40	3330-S-3.5	■	■	■
4.00	5.00	6.00	40	3330-S-4.0	■	■	■
4.50	5.00	6.00	40	3330-S-4.5	■	■	■
5.00	6.00	6.00	40	3330-S-5.0	■	■	■
6.00	7.00	6.00	40	3330-S-6.0	■	■	■

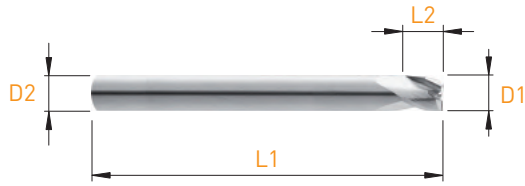

MD VHM HM	$\lambda 30^\circ$	Sharp Corner		Z=3	
-----------------	--------------------	-----------------	--	-----	--

D1 e9	L2	D2 h6	L1	Art. N°	Z	TiAlN	STF
3.00	3.00	3.00	39	3330-3.0	■	■	■
4.00	4.00	4.00	50	3330-4.0	■	■	■
5.00	5.00	5.00	50	3330-5.0	■	■	■
6.00	6.00	6.00	50	3330-6.0	■	■	■
8.00	8.00	8.00	58	3330-8.0	■		
10.00	10.00	10.00	66	3330-10.0	■		
12.00	12.00	12.00	73	3330-12.0	■		

Fraises en bout de finition

Schlicht Schafffräser

Finishing end mills

3330-4

new

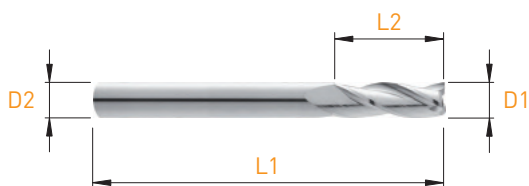

D1 h10	L2	D2 h5	L1	Art. N°	Z	TiAlN	STF
3.00	12.00	6.00	50	3330-4-3.0	■	■	■
4.00	16.00	6.00	50	3330-4-4.0	■	■	■
5.00	20.00	6.00	50	3330-4-5.0	■	■	■
6.00	24.00	6.00	57	3330-4-6.0	■	■	■

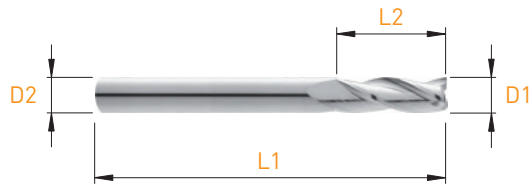

D1 e9	L2	D2 h5	L1	Art. N°	Z	TiAlN	STF
2.00	8.00	2.00	32	3331-2.0	■	■	■
2.50	8.00	2.50	32	3331-2.5	■	■	■
3.00	12.00	3.00	32	3331-3.0	■	■	■
3.50	12.00	3.50	32	3331-3.5	■	■	■
4.00	12.00	4.00	40	3331-4.0	■	■	■
4.50	14.00	4.50	50	3331-4.5	■	■	■
5.00	14.00	5.00	50	3331-5.0	■	■	■
6.00	16.00	6.00	50	3331-6.0	■	■	■

Fraises en bout de finition

Schlicht Schafffräser

Finishing end mills

3336-HA / 3337-HA

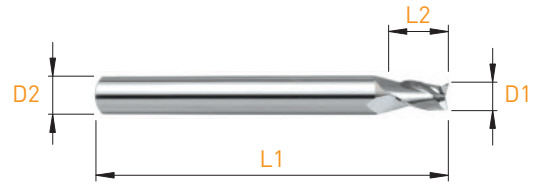
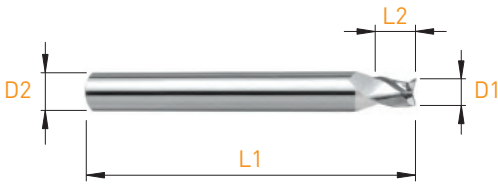

MD VHM HM	λ 30°	Sharp Corner		DIN 6527K	Z=3	
-----------------	---------------	-----------------	--	--------------	-----	--

D1 h10	L2	D2 h5	L1	Art. N°	Z	TiAlN	STF
1.50	3.00	6.00	50	3336-HA-1.5	■	■	■
1.80	3.00	6.00	50	3336-HA-1.8	■	■	■
2.00	3.00	6.00	50	3336-HA-2.0	■	■	■
2.50	3.00	6.00	50	3336-HA-2.5	■	■	■
2.80	4.00	6.00	50	3336-HA-2.8	■	■	■
3.00	4.00	6.00	50	3336-HA-3.0	■	■	■
3.50	4.00	6.00	50	3336-HA-3.5	■	■	■
3.80	5.00	6.00	54	3336-HA-3.8	■	■	■
4.00	5.00	6.00	54	3336-HA-4.0	■	■	■
4.50	5.00	6.00	54	3336-HA-4.5	■	■	■
4.80	6.00	6.00	54	3336-HA-4.8	■	■	■
5.00	6.00	6.00	54	3336-HA-5.0	■	■	■
5.50	7.00	6.00	54	3336-HA-5.5	■	■	■
5.80	7.00	6.00	54	3336-HA-5.8	■	■	■
6.00	7.00	6.00	54	3336-HA-6.0	■	■	■

MD VHM HM	λ 30°	Sharp Corner		DIN 6527L	Z=3	
-----------------	---------------	-----------------	--	--------------	-----	--

D1 h10	L2	D2 h5	L1	Art. N°	Z	TiAlN	STF
1.50	6.00	6.00	57	3337-HA-1.5	■	■	■
1.80	6.00	6.00	57	3337-HA-1.8	■	■	■
2.00	6.00	6.00	57	3337-HA-2.0	■	■	■
2.50	6.00	6.00	57	3337-HA-2.5	■	■	■
2.80	7.00	6.00	57	3337-HA-2.8	■	■	■
3.00	7.00	6.00	57	3337-HA-3.0	■	■	■
3.50	7.00	6.00	57	3337-HA-3.5	■	■	■
3.80	8.00	6.00	57	3337-HA-3.8	■	■	■
4.00	8.00	6.00	57	3337-HA-4.0	■	■	■
4.50	8.00	6.00	57	3337-HA-4.5	■	■	■
4.80	10.00	6.00	57	3337-HA-4.8	■	■	■
5.00	10.00	6.00	57	3337-HA-5.0	■	■	■
5.50	10.00	6.00	57	3337-HA-5.5	■	■	■
5.80	10.00	6.00	57	3337-HA-5.8	■	■	■
6.00	10.00	6.00	57	3337-HA-6.0	■	■	■

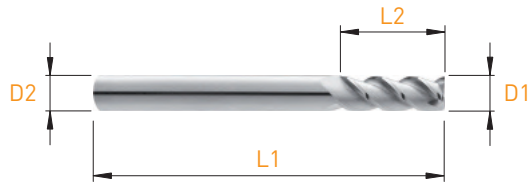

D1 e9	L2	D2 h5	L1	Art. N°	Z	TiAlN	STF
2.00	8.00	2.00	32	3341-2.0	■	■	■
2.50	8.00	2.50	32	3341-2.5	■	■	■
3.00	12.00	3.00	32	3341-3.0	■	■	■
3.50	12.00	3.50	32	3341-3.5	■	■	■
4.00	12.00	4.00	40	3341-4.0	■	■	■
4.50	14.00	4.50	50	3341-4.5	■	■	■
5.00	14.00	5.00	50	3341-5.0	■	■	■
6.00	16.00	6.00	50	3341-6.0	■	■	■

Fraises en bout de finition

Schlicht Schafffräser

Finishing end mills

3345-S

new

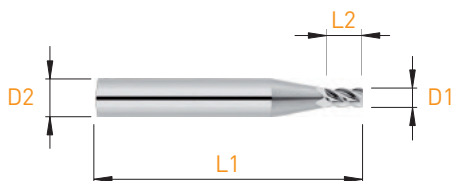

D1 h10	L2	D2 h6	L1	Art. N°	Z	TAIN	STF
0.50	1.00	6.00	40	3345-S-0.5	■	■	■
0.60	1.20	6.00	40	3345-S-0.6	■	■	■
0.70	1.40	6.00	40	3345-S-0.7	■	■	■
0.80	1.60	6.00	40	3345-S-0.8	■	■	■
0.90	1.80	6.00	40	3345-S-0.9	■	■	■
1.00	2.00	6.00	40	3345-S-1.0	■	■	■
1.10	2.20	6.00	40	3345-S-1.1	■	■	■
1.20	2.40	6.00	40	3345-S-1.2	■	■	■
1.30	2.60	6.00	40	3345-S-1.3	■	■	■
1.40	2.80	6.00	40	3345-S-1.4	■	■	■
1.50	3.00	6.00	40	3345-S-1.5	■	■	■
1.60	3.20	6.00	40	3345-S-1.6	■	■	■
1.70	3.40	6.00	40	3345-S-1.7	■	■	■
1.80	3.60	6.00	40	3345-S-1.8	■	■	■
1.90	3.80	6.00	40	3345-S-1.9	■	■	■
2.00	4.00	6.00	40	3345-S-2.0	■	■	■
2.10	4.20	6.00	40	3345-S-2.1	■	■	■
2.20	4.40	6.00	40	3345-S-2.2	■	■	■
2.30	4.60	6.00	40	3345-S-2.3	■	■	■
2.40	4.80	6.00	40	3345-S-2.4	■	■	■
2.50	5.00	6.00	40	3345-S-2.5	■	■	■
2.60	5.20	6.00	40	3345-S-2.6	■	■	■
2.70	5.40	6.00	40	3345-S-2.7	■	■	■
2.80	5.60	6.00	40	3345-S-2.8	■	■	■
2.90	5.80	6.00	40	3345-S-2.9	■	■	■
3.00	6.00	6.00	40	3345-S-3.0	■	■	■
3.50	7.00	6.00	40	3345-S-3.5	■	■	■
4.00	8.00	6.00	40	3345-S-4.0	■	■	■
4.50	9.00	6.00	40	3345-S-4.5	■	■	■
5.00	10.00	6.00	40	3345-S-5.0	■	■	■
6.00	12.00	6.00	40	3345-S-6.0	■	■	■

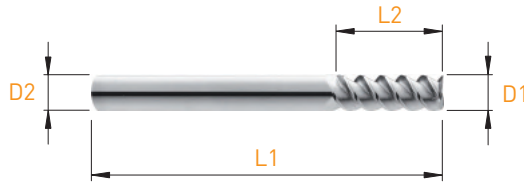

D1 e9	L2	D2 h5	L1	Art. N°	Z	TiAlN	STF
2.00	8.00	2.00	32	3361-2.0	■	■	■
2.50	8.00	2.50	32	3361-2.5	■	■	■
3.00	12.00	3.00	32	3361-3.0	■	■	■
3.50	12.00	3.50	32	3361-3.5	■	■	■
4.00	12.00	4.00	40	3361-4.0	■	■	■
4.50	14.00	4.50	50	3361-4.5	■	■	■
5.00	14.00	5.00	50	3361-5.0	■	■	■
6.00	16.00	6.00	50	3361-6.0	■	■	■

Fraises en bout de finition

Schlicht Schafffräser

Finishing end mills

DHP3336



DHP

Denture à pas irrégulier, angle d'hélice progressif
 Ungleiche Teilung, progressive Drallwinkel
 Uneven tooth pitch, progressive helix angle

D1 h10	L2	D2 h5	L1	Art. N°	Z	TIALIN	STF
1.00	4.00	6.00	40	DHP3336-1.0	■	■	■
1.50	4.00	6.00	40	DHP3336-1.5	■	■	■
2.00	4.00	6.00	40	DHP3336-2.0	■	■	■
2.50	4.00	6.00	40	DHP3336-2.5	■	■	■
3.00	5.00	6.00	40	DHP3336-3.0	■	■	■
3.50	5.00	6.00	40	DHP3336-3.5	■	■	■
4.00	6.00	6.00	40	DHP3336-4.0	■	■	■
5.00	7.00	6.00	40	DHP3336-5.0	■	■	■
6.00	8.00	6.00	40	DHP3336-6.0	■	■	■



D1 e9	L2	D2 h5	L1	Art. N°	Z	TiAlN	STF
3.00	3.00	3.00	39	3430-3.0	■	■	■
4.00	4.00	4.00	50	3430-4.0	■	■	■
5.00	5.00	5.00	50	3430-5.0	■	■	■
6.00	6.00	6.00	50	3430-6.0	■	■	■

Fraises en bout de finition

Schlicht Schafffräser

Finishing end mills

3431

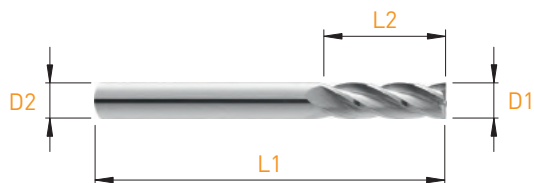

D1 e9	L2	D2 h5	L1	Art. N°	Z	TAIN	STF
2.00	8.00	2.00	32	3431-2.0	■	■	■
2.50	8.00	2.50	32	3431-2.5	■	■	■
3.00	12.00	3.00	32	3431-3.0	■	■	■
3.50	12.00	3.50	32	3431-3.5	■	■	■
4.00	12.00	4.00	40	3431-4.0	■	■	■
4.50	14.00	4.50	50	3431-4.5	■	■	■
5.00	14.00	5.00	50	3431-5.0	■	■	■
6.00	16.00	6.00	50	3431-6.0	■	■	■

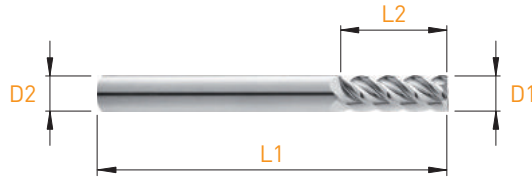

D1 e9	L2	D2 h5	L1	Art. N°	Z	TiAlN	STF
2.00	8.00	2.00	32	3441-2.0	■	■	■
2.50	8.00	2.50	32	3441-2.5	■	■	■
3.00	12.00	3.00	32	3441-3.0	■	■	■
3.50	12.00	3.50	32	3441-3.5	■	■	■
4.00	12.00	4.00	40	3441-4.0	■	■	■
4.50	14.00	4.50	50	3441-4.5	■	■	■
5.00	14.00	5.00	50	3441-5.0	■	■	■
6.00	16.00	6.00	50	3441-6.0	■	■	■

Fraises en bout de finition

Schlicht Schafffräser

Finishing end mills

3445-S

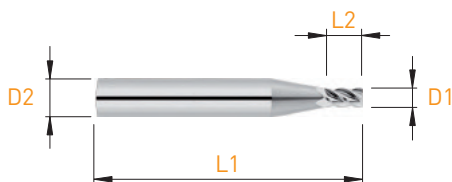

D1 h10	L2	D2 h6	L1	Art. N°	Z	TIAIN	STF
0.50	1.00	6.00	40	3445-S-0.5	■	■	new
0.60	1.20	6.00	40	3445-S-0.6	■	■	new
0.70	1.40	6.00	40	3445-S-0.7	■	■	new
0.80	1.60	6.00	40	3445-S-0.8	■	■	new
0.90	1.80	6.00	40	3445-S-0.9	■	■	new
1.00	2.00	6.00	40	3445-S-1.0	■	■	
1.10	2.20	6.00	40	3445-S-1.1	■	■	new
1.20	2.40	6.00	40	3445-S-1.2	■	■	new
1.30	2.60	6.00	40	3445-S-1.3	■	■	new
1.40	2.80	6.00	40	3445-S-1.4	■	■	new
1.50	3.00	6.00	40	3445-S-1.5	■	■	
1.60	3.20	6.00	40	3445-S-1.6	■	■	new
1.70	3.40	6.00	40	3445-S-1.7	■	■	new
1.80	3.60	6.00	40	3445-S-1.8	■	■	new
1.90	3.80	6.00	40	3445-S-1.9	■	■	new
2.00	4.00	6.00	40	3445-S-2.0	■	■	
2.10	4.20	6.00	40	3445-S-2.1	■	■	new
2.20	4.40	6.00	40	3445-S-2.2	■	■	new
2.30	4.60	6.00	40	3445-S-2.3	■	■	new
2.40	4.80	6.00	40	3445-S-2.4	■	■	new
2.50	5.00	6.00	40	3445-S-2.5	■	■	
2.60	5.20	6.00	40	3445-S-2.6	■	■	new
2.70	5.40	6.00	40	3445-S-2.7	■	■	new
2.80	5.60	6.00	40	3445-S-2.8	■	■	new
2.90	5.80	6.00	40	3445-S-2.9	■	■	new
3.00	6.00	6.00	40	3445-S-3.0	■	■	
3.50	7.00	6.00	40	3445-S-3.5	■	■	
4.00	8.00	6.00	40	3445-S-4.0	■	■	
4.50	9.00	6.00	40	3445-S-4.5	■	■	
5.00	10.00	6.00	40	3445-S-5.0	■	■	
6.00	12.00	6.00	40	3445-S-6.0	■	■	

new

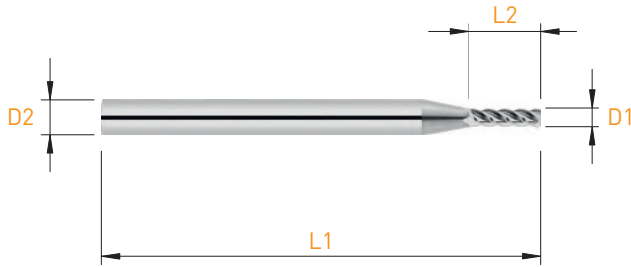

D1 h10	L2	D2 h5	L1	Art. N°	Z	TiAIN	STF
1.00	1.50	6.00	50	3450-1.0	■	■	■
1.50	2.25	6.00	50	3450-1.5	■	■	■
2.00	3.00	6.00	50	3450-2.0	■	■	■
2.50	3.75	6.00	50	3450-2.5	■	■	■
3.00	4.50	6.00	50	3450-3.0	■	■	■
3.50	5.25	6.00	50	3450-3.5	■	■	■
4.00	6.00	6.00	50	3450-4.0	■	■	■
5.00	7.50	6.00	50	3450-5.0	■	■	■
6.00	9.00	6.00	50	3450-6.0	■	■	■

Fraises en bout de finition

Schlicht Schafffräser

Finishing end mills

DHP3436

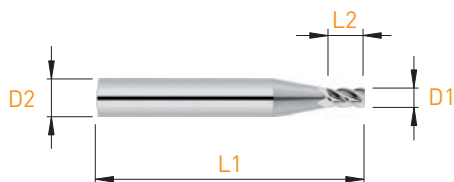

DHP

Denture à pas irrégulier, angle d'hélice progressive
 Ungleiche Teilung, progressive Drallwinkel
 Uneven tooth pitch, progressive helix angle

D1 h10	L2	D2 h5	L1	Art. N°	Z	TiAIN	STF
1.00	4.00	6.00	40	DHP3436-1.0	■	■	■
1.50	4.00	6.00	40	DHP3436-1.5	■	■	■
2.00	4.00	6.00	40	DHP3436-2.0	■	■	■
2.50	4.00	6.00	40	DHP3436-2.5	■	■	■
3.00	5.00	6.00	40	DHP3436-3.0	■	■	■
3.50	5.00	6.00	40	DHP3436-3.5	■	■	■
4.00	6.00	6.00	40	DHP3436-4.0	■	■	■
5.00	7.00	6.00	40	DHP3436-5.0	■	■	■
6.00	8.00	6.00	40	DHP3436-6.0	■	■	■

new

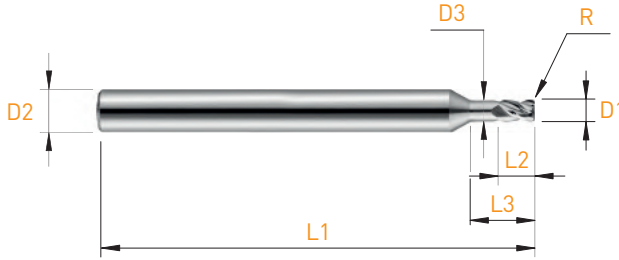

MD VHM HM	λ 30°	Radius Corner		L3 2.5xD1	Z=4	
-----------------	---------------	------------------	--	--------------	-----	--

D1 h10	R +/- 0.02	L2	L3	D3	D2 h5	L1	Art. N°	Z	TiAlN	STF
3.00	0.50	3.00	7.50	2.95	6.00	57	3439T-2.5X-3.0	■	■	■
3.50	0.50	3.50	8.75	3.45	6.00	57	3439T-2.5X-3.5	■	■	■
4.00	0.50	4.00	10.00	3.95	6.00	57	3439T-2.5X-4.0	■	■	■
4.50	0.50	4.50	11.25	4.45	6.00	57	3439T-2.5X-4.5	■	■	■
5.00	0.50	5.00	12.50	4.95	6.00	57	3439T-2.5X-5.0	■	■	■
5.50	0.50	5.50	13.75	5.45	6.00	57	3439T-2.5X-5.5	■	■	■
6.00	0.50	6.00	15.00	5.95	6.00	57	3439T-2.5X-6.0	■	■	■

Fraises en bout toriques

Torische Schaftfräser

Toric end mills

3439T-4X

new

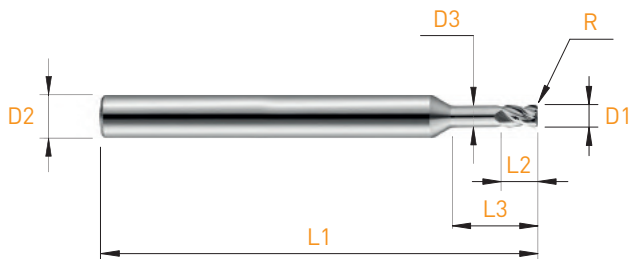

D1 h10	R +/- 0.02	L2	L3	D3	D2 h5	L1	Art. N°	Z	TiAlN	STF
3.00	0.50	3.00	12.00	2.95	6.00	57	3439T-4X-3.0	■	■	■
3.50	0.50	3.50	14.00	3.45	6.00	57	3439T-4X-3.5	■	■	■
4.00	0.50	4.00	16.00	3.95	6.00	57	3439T-4X-4.0	■	■	■
4.50	0.50	4.50	18.00	4.45	6.00	57	3439T-4X-4.5	■	■	■
5.00	0.50	5.00	20.00	4.95	6.00	57	3439T-4X-5.0	■	■	■
5.50	0.50	5.50	22.00	5.45	6.00	57	3439T-4X-5.5	■	■	■
6.00	0.50	6.00	24.00	5.95	6.00	57	3439T-4X-6.0	■	■	■

new

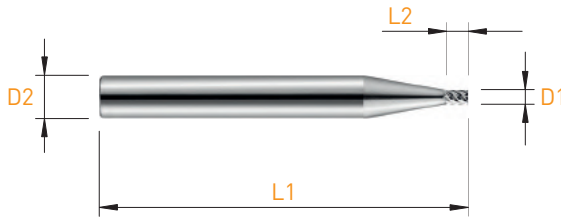

MD VHM HM	λ 45°	Sharp Corner		1.5xD1	Z=5	
-----------------	---------------	-----------------	--	--------	-----	--

D1 h10	L2	D2 h5	L1	Art. N°	Z	TiAIN	STF
1.00	1.50	6.00	50	3545-1.0	■	■	■
2.00	3.00	6.00	50	3545-2.0	■	■	■
3.00	4.50	6.00	50	3545-3.0	■	■	■
4.00	6.00	6.00	50	3545-4.0	■	■	■
5.00	7.50	6.00	50	3545-5.0	■	■	■
6.00	9.00	6.00	50	3545-6.0	■	■	■

Fraises en bout de finition

Schlicht Schafffräser

Finishing end mills

35645

new

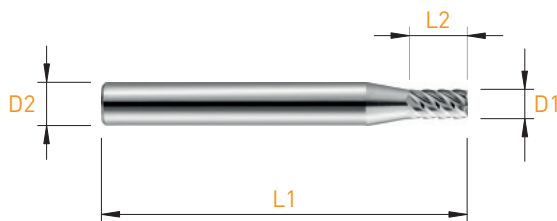
MD
VHM
HM λ 45°Sharp
CornerZ=4
Z=5
Z=6

D1 h10	L2	Z	D2 h5	L1	Art. N°	Z	TiAIN	STF
1.00	2.00	4	6.00	50	35645-1.0	■	■	■
1.50	3.00	5	6.00	50	35645-1.5	■	■	■
2.00	4.00	5	6.00	50	35645-2.0	■	■	■
2.50	5.00	5	6.00	50	35645-2.5	■	■	■
3.00	6.00	5	6.00	50	35645-3.0	■	■	■
3.50	7.00	5	6.00	50	35645-3.5	■	■	■
4.00	8.00	6	6.00	50	35645-4.0	■	■	■
4.50	9.00	6	6.00	50	35645-4.5	■	■	■
5.00	10.00	6	6.00	50	35645-5.0	■	■	■
6.00	12.00	6	6.00	50	35645-6.0	■	■	■

new

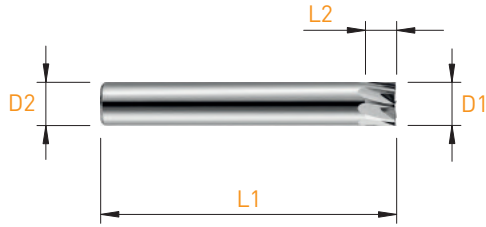

D1 e9	L2	D2 h5	L1	Art. N°	Z	TiAIN	STF
6.00	4.00	6.00	50	3810-0.65-6.0	■	■	■
6.00	6.00	6.00	57	3810-1.0-6.0	■	■	■
6.00	9.00	6.00	57	3810-1.5-6.0	■	■	■

Fraises en bout hémisphériques

Vollradius Schaftfräser

Ball nose end mills

3238

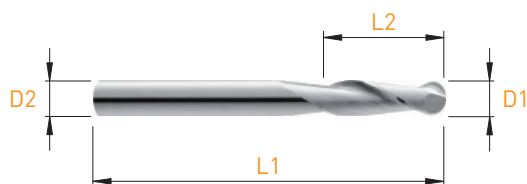

D1 e9	L2	D2 h5	L1	Art. N°	Z	TAIN	STF
2.00	8.00	2.00	32	3238-2.0	■	■	■
2.50	8.00	2.50	32	3238-2.5	■	■	■
3.00	12.00	3.00	32	3238-3.0	■	■	■
3.50	12.00	3.50	32	3238-3.5	■	■	■
4.00	12.00	4.00	40	3238-4.0	■	■	■
4.50	14.00	4.50	50	3238-4.5	■	■	■
5.00	14.00	5.00	50	3238-5.0	■	■	■
6.00	16.00	6.00	50	3238-6.0	■	■	■

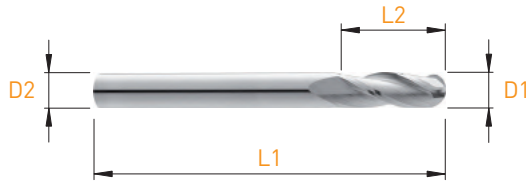

D1 e9	L2	D2 h5	L1	Art. N°	Z	TAIN	STF
2.00	8.00	2.00	32	3338-2.0	■	■	■
2.50	8.00	2.50	32	3338-2.5	■	■	■
3.00	12.00	3.00	32	3338-3.0	■	■	■
3.50	12.00	3.50	32	3338-3.5	■	■	■
4.00	12.00	4.00	40	3338-4.0	■	■	■
4.50	14.00	4.50	50	3338-4.5	■	■	■
5.00	14.00	5.00	50	3338-5.0	■	■	■
6.00	16.00	6.00	50	3338-6.0	■	■	■

Outils pour machine WM 701S

Werkzeuge für Maschine WM 701S

Executions for machine WM 701S



Tous les outils de la gamme MICRO-Line sont réalisables pour la machine WM 701S sur demande.

Alle Werkzeuge aus der MICRO-Line sind machbar für die Maschine WM 701S auf Anfrage.

All tools of MICRO-Line can be produced for the machine WM 701S on request.

Fraises en bout de finition pour machine WM 701S

Schafffräser für Maschine WM 701S

End mills for machine WM 701S

701S3371

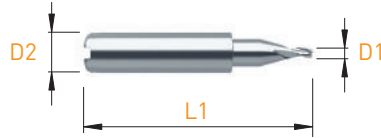

Sharp Corner		1xD1	Z=3	Disponible tous les 0.1 mm Verfügbar jede 0.1 mm Available each 0.1 mm
--------------	--	------	-----	--

D1 +0.005 / -0.010	L2	D2 h5	L1	Art. N°	Z	TiAlN	STF	TiCN	DLC
0.30	0.30	6.00	33	701S3371-1-0.30	■	■	■	■	■
⋮	⋮	⋮	⋮	⋮	⋮	⋮	⋮	⋮	⋮
3.50	3.50	6.00	33	701S3371-1-3.50	■	■	■	■	■

Sharp Corner		2xD1	Z=3	Disponible tous les 0.1 mm Verfügbar jede 0.1 mm Available each 0.1 mm
--------------	--	------	-----	--

D1 +0.005 / -0.010	L2	D2 h5	L1	Art. N°	Z	TiAlN	STF	TiCN	DLC
0.30	0.60	6.00	33	701S3371-2-0.30	■	■	■	■	■
⋮	⋮	⋮	⋮	⋮	⋮	⋮	⋮	⋮	⋮
3.50	7.00	6.00	33	701S3371-2-3.50	■	■	■	■	■

Sharp Corner		3xD1	Z=3	Disponible tous les 0.1 mm Verfügbar jede 0.1 mm Available each 0.1 mm
--------------	--	------	-----	--

D1 +0.005 / -0.010	L2	D2 h5	L1	Art. N°	Z	TiAlN	STF	TiCN	DLC
0.30	0.90	6.00	33	701S3371-3-0.30	■	■	■	■	■
⋮	⋮	⋮	⋮	⋮	⋮	⋮	⋮	⋮	⋮
3.00	9.00	6.00	33	701S3371-3-3.00	■	■	■	■	■

Fraises en bout pour usinage en bout plat

Schafffräser für flache Frontbearbeitung

End mills for flat front machining

3383

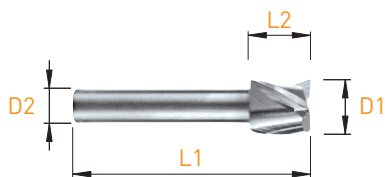

D1 h10	L2	D2 h6	L1	Art. N°	Z
8.00	8.00	6.00	40	3383-8.0	■
10.00	10.00	6.00	40	3383-10.0	■
12.00	12.00	6.00	40	3383-12.0	■

MICRO-LINE

Fraises en bout avec queue réduite
 Schafffräser mit reduziertem Schaft
 End mills with reduced shank

3831 / 3833

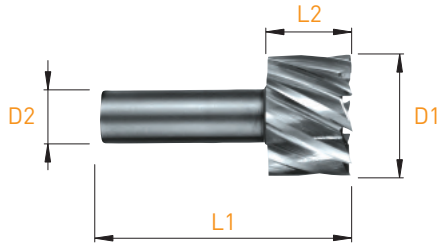

MD VHM HM	λ 30°	Sharp Corner		Z=10
-----------------	---------------	-----------------	--	------

D1 h10	L2	D2 h6	L1	Art. N°	Z
16.30	15.00	10.00	45	3831	■
20.30	15.00	10.00	45	3833	■

Fraises à angler

Kegelsenker

Chamfering tools

3611

new



MD VHM HM	λ^{0°		Z=3	60°
-----------------	---------------------	--	-----	-----

D1 +0.005 / -0.010	L2	D2 h4	L1	d	Art. N°	Z	TIALN	STF
0.50	3.00	3.00	39	0.10	3611-0.5	■	■	■
0.60	3.00	3.00	39	0.10	3611-0.6	■	■	■
0.70	3.00	3.00	39	0.10	3611-0.7	■	■	■
0.80	3.00	3.00	39	0.10	3611-0.8	■	■	■
0.90	3.00	3.00	39	0.10	3611-0.9	■	■	■
1.00	3.00	3.00	39	0.10	3611-1.0	■	■	■
1.50	4.50	3.00	39	0.10	3611-1.5	■	■	■
2.00	6.00	3.00	39	0.10	3611-2.0	■	■	■
2.50	7.50	3.00	39	0.10	3611-2.5	■	■	■
3.00	-	3.00	39	0.10	3611-3.0	■	■	■



MD VHM HM	λ^{0°		Z=3	90°
-----------------	---------------------	--	-----	-----

D1	L2	D2 _{h4}	L1	d	Art. N°	Z	TiAlN	STF
0.50	3.00	3.00	39	0.10	3911-0.5	■	■	■
0.60	3.00	3.00	39	0.10	3911-0.6	■	■	■
0.70	3.00	3.00	39	0.10	3911-0.7	■	■	■
0.80	3.00	3.00	39	0.10	3911-0.8	■	■	■
0.90	3.00	3.00	39	0.10	3911-0.9	■	■	■
1.00	3.00	3.00	39	0.10	3911-1.0	■	■	■
1.50	4.50	3.00	39	0.10	3911-1.5	■	■	■
2.00	6.00	3.00	39	0.10	3911-2.0	■	■	■
2.50	7.50	3.00	39	0.10	3911-2.5	■	■	■
3.00	-	3.00	39	0.10	3911-3.0	■	■	■

Fraises à angler

Kegelsenker

Chamfering tools

1901 / 3901





MD VHM HM	λ^{0°		Z=4	90°	L		R		
D Ø3h4 Ø6h5 Ø8h6	d	L1	Art. N°	Z	Art. N°	Z	TiAlN	STF	
3.00	0.30	39	1901-3.0	■	3901-3.0	■	■	■	
6.00	0.70	50	1901-6.0	■	3901-6.0	■	■	■	
8.00	1.20	59	1901-8.0	■	3901-8.0	■	■	■	

Fraises à graver

Gravierfräser

Engraving mills

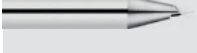
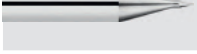
Paramètres de coupe indicatif Empfohlene Schnittwerte Standard machining data					14.99
	A	Plat [E] / Rayon [r] Fläche [E] / Radius [r] Flat [E] / Radius [r]	D	Type Typ Type	Page Seite Page
	20° / 30° / 35° / 40° 45° / 50° / 55° / 60° 65° / 70° / 90° / 120°	0.05-0.30 0.05-0.10 / every 0.01 0.10-0.30 / every 0.05	Ø3h4 Ø6h5	E100-P	14.100 new
	20° / 30° / 35° / 40° 45° / 50° / 55° / 60° 65° / 70° / 90°	0.02-0.30 0.02-0.10 / every 0.01 0.10-0.30 / every 0.05	Ø3h4	E300-P	14.101
	20° / 30° / 35° / 40° 45° / 50° / 55° / 60° 65° / 70° / 90°	0.04-0.30 0.04-0.10 / every 0.01 0.10-0.30 / every 0.05	Ø3h4	E300-R	14.102
	20° / 30° / 35° / 40° 45° / 50° / 55° / 60° 65° / 70° / 90°	0.04-0.30 0.04-0.10 / every 0.01 0.10-0.30 / every 0.05	Ø3h4	E900-P	14.103

Fraises à graver

Gravierfräser

Engraving mills

Paramètres de coupe indicatifs

Empfohlene Schnittwerte

Standard machining data

Matière Werkstoff Material	n	Vf	Z	TiAlN	STF	TiCN	DLC
	[tr/min]	[mm/min]					
Acier de décolletage Automatenstahl Free-cutting steel (P)	20 - 50'000	100 - 180	-	***	***	**	-
Acier Stahl < 600 N/mm ² (P)	20 - 50'000	100 - 180	-	***	***	**	-
Acier Stahl < 800 N/mm ² (P)	20 - 50'000	100 - 180	-	***	***	**	-
Acier Stahl > 800 N/mm ² (P)	20 - 50'000	100 - 150	-	***	***	**	-
Acier trempé Gehärteter Stahl -55HRC (H)	20 - 50'000	-	-	***	***	*	-
Acier trempé Gehärteter Stahl +55HRC (H)	20 - 50'00	-	-	***	***	*	-
Inox Rostfreistahl Stainless steel (M)	20 - 50'000	100 - 170	-	***	***	**	-
Aluminium (N)	20 - 50'000	100 - 250	***	**	**	*	***
Cuivre, laiton, bronze Kupfer, Messing, Bronze Copper, brass, bronze (N)	20 - 50'000	70 - 150	***	**	**	**	***
Matière synthétique Synthetisches Material Synthetic material (N)	20 - 50'000	100 - 200	***	**	**	**	***
Métaux précieux Edelmetalle Precious metals (N)	20 - 50'000	100 - 200	***	**	**	**	***
Titane Titan Titanium (S)	20 - 50'000	70 - 150	-	***	***	**	-
Alliage de nickel Nickel-Legierung Nickel alloy (S)	20 - 50'000	80 - 180	-	***	***	**	-
Matière exotique Exotisches material Exotic material (O)	20 - 50'000	80 - 180	*	***	***	**	***

Avec revêtement, augmenter les valeurs de 20-30%

Mit Beschichtung, Daten um 20-30% erhöhen

With coating, increase data by 20-30%

* Bien / Gut / Good

** Très bien / Sehr Gut / Very good

*** Excellent / Ausgezeichnet / Excellent

MICRO-LINE

Fraises à graver avec plat
 Gravierfräser mit Fläche
 Engraving mills with flat

E100-P

new

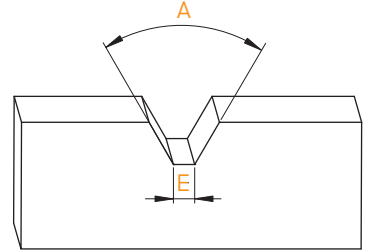
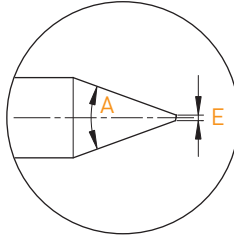

MD
 VHM
 HM

A	E	L2	D2 h4 Ø3.0 h5 Ø6.0	L1	Art. N°	Z	TiAlN	STF	TiCN	DLC
20°	0.05-0.10* / 0.10-0.30 **	5.20	3.00	33	E120-P-_(E)	■	■	■	■	■
30°	0.05-0.10* / 0.10-0.30 **	5.20	3.00	33	E130-P-_(E)	■	■	■	■	■
35°	0.05-0.10* / 0.10-0.30 **	5.20	3.00	33	E135-P-_(E)	■	■	■	■	■
40°	0.05-0.10* / 0.10-0.30 **	6.00	3.00	33	E140-P-_(E)	■	■	■	■	■
45°	0.05-0.10* / 0.10-0.30 **	6.00	3.00	33	E145-P-_(E)	■	■	■	■	■
50°	0.05-0.10* / 0.10-0.30 **	6.00	3.00	33	E150-P-_(E)	■	■	■	■	■
55°	0.05-0.10* / 0.10-0.30 **	6.00	3.00	33	E155-P-_(E)	■	■	■	■	■
60°	0.05-0.10* / 0.10-0.30 **	8.00	3.00	33	E160-P-_(E)	■	■	■	■	■
65°	0.05-0.10* / 0.10-0.30 **	8.00	3.00	33	E165-P-_(E)	■	■	■	■	■
70°	0.05-0.10* / 0.10-0.30 **	8.00	3.00	33	E170-P-_(E)	■	■	■	■	■
90°	0.05-0.10* / 0.10-0.30 **	8.00	3.00	33	E190-P-_(E)	■	■	■	■	■
120°	0.05-0.10* / 0.10-0.30 **	8.00	3.00	33	E1120-P-_(E)	■	■	■	■	■
30°	0.05-0.10* / 0.10-0.30 **	12.00	6.00	40	E130-6-P-_(E)	■	■	■	■	■
40°	0.05-0.10* / 0.10-0.30 **	12.00	6.00	40	E140-6-P-_(E)	■	■	■	■	■

* tous les 0.01 mm
 alle 0.01 mm
 every 0.01 mm

** tous les 0.05 mm
 alle 0.05 mm
 every 0.05 mm

Fraises à graver avec plat

Gravierfräser mit Fläche

Engraving mills with flat

E300-P

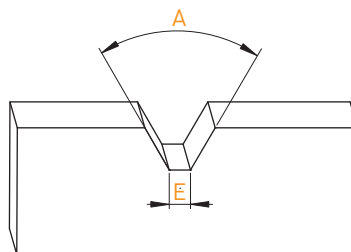
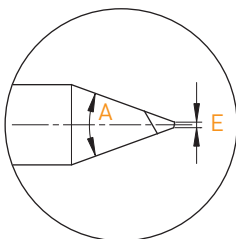

MD
VHM
HM

A	E	D h4	L1	Art. N°	Z	TiAIN	STF	TiCN	DLC
20°	0.02-0.10* / 0.10-0.30**	3.00	33	E320-P-_(E)	■	■	■	■	■
30°	0.02-0.10* / 0.10-0.30**	3.00	33	E330-P-_(E)	■	■	■	■	■
35°	0.02-0.10* / 0.10-0.30**	3.00	33	E335-P-_(E)	■	■	■	■	■
40°	0.02-0.10* / 0.10-0.30**	3.00	33	E340-P-_(E)	■	■	■	■	■
45°	0.02-0.10* / 0.10-0.30**	3.00	33	E345-P-_(E)	■	■	■	■	■
50°	0.02-0.10* / 0.10-0.30**	3.00	33	E350-P-_(E)	■	■	■	■	■
55°	0.02-0.10* / 0.10-0.30**	3.00	33	E355-P-_(E)	■	■	■	■	■
60°	0.02-0.10* / 0.10-0.30**	3.00	33	E360-P-_(E)	■	■	■	■	■
65°	0.02-0.10* / 0.10-0.30**	3.00	33	E365-P-_(E)	■	■	■	■	■
70°	0.02-0.10* / 0.10-0.30**	3.00	33	E370-P-_(E)	■	■	■	■	■
90°	0.02-0.10* / 0.10-0.30**	3.00	33	E390-P-_(E)	■	■	■	■	■

* tous les 0.01 mm
alle 0.01 mm
every 0.01 mm

** tous les 0.05 mm
alle 0.05 mm
every 0.05 mm

MICRO-LINE

Fraises à graver à rayon

Gravierfräser mit Radius

Engraving mills with radius

E300-R

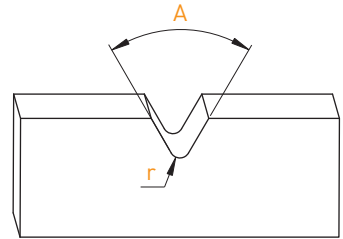
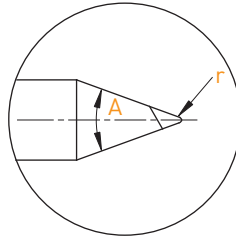

MD
VHM
HM

A	r	D h4	L1	Art. N°	N	TiAIN	STF	TiCN	DLC
20°	0.04-0.10* / 0.10-0.30**	3.00	33	E320-R_(r)	■	■	■	■	■
30°	0.04-0.10* / 0.10-0.30**	3.00	33	E330-R_(r)	■	■	■	■	■
35°	0.04-0.10* / 0.10-0.30**	3.00	33	E335-R_(r)	■	■	■	■	■
40°	0.04-0.10* / 0.10-0.30**	3.00	33	E340-R_(r)	■	■	■	■	■
45°	0.04-0.10* / 0.10-0.30**	3.00	33	E345-R_(r)	■	■	■	■	■
50°	0.04-0.10* / 0.10-0.30**	3.00	33	E350-R_(r)	■	■	■	■	■
55°	0.04-0.10* / 0.10-0.30**	3.00	33	E355-R_(r)	■	■	■	■	■
60°	0.04-0.10* / 0.10-0.30**	3.00	33	E360-R_(r)	■	■	■	■	■
65°	0.04-0.10* / 0.10-0.30**	3.00	33	E365-R_(r)	■	■	■	■	■
70°	0.04-0.10* / 0.10-0.30**	3.00	33	E370-R_(r)	■	■	■	■	■
90°	0.04-0.10* / 0.10-0.30**	3.00	33	E390-R_(r)	■	■	■	■	■

* tous les 0.01 mm
alle 0.01 mm
every 0.01 mm

** tous les 0.05 mm
alle 0.05 mm
every 0.05 mm

Fraises à graver renforcées

Verstärkte Gravierfräser

Reinforced engraving mills

E900-P

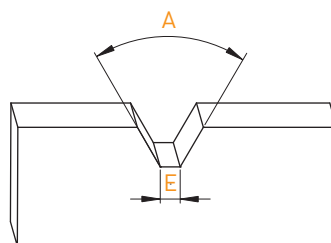
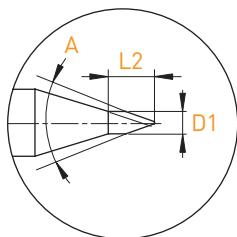

MD
VHM
HM

A	E	D1	L2	D _{h4}	L1	Art. N°	Z	TiAIN	STF	TiCN	DLC
20°	0.04-0.10* / 0.10-0.30**	0.60	1.80	3.00	33	E920-P-_(E)	■	■	■	■	■
30°	0.04-0.10* / 0.10-0.30**	0.60	1.80	3.00	33	E930-P-_(E)	■	■	■	■	■
35°	0.04-0.10* / 0.10-0.30**	0.60	1.80	3.00	33	E935-P-_(E)	■	■	■	■	■
40°	0.04-0.10* / 0.10-0.30**	0.60	1.80	3.00	33	E940-P-_(E)	■	■	■	■	■
45°	0.04-0.10* / 0.10-0.30**	1.00	1.80	3.00	33	E945-P-_(E)	■	■	■	■	■
50°	0.04-0.10* / 0.10-0.30**	1.00	2.00	3.00	33	E950-P-_(E)	■	■	■	■	■
55°	0.04-0.10* / 0.10-0.30**	1.00	2.00	3.00	33	E955-P-_(E)	■	■	■	■	■
60°	0.04-0.10* / 0.10-0.30**	1.20	2.00	3.00	33	E960-P-_(E)	■	■	■	■	■
65°	0.04-0.10* / 0.10-0.30**	1.20	2.00	3.00	33	E965-P-_(E)	■	■	■	■	■
70°	0.04-0.10* / 0.10-0.30**	1.20	2.00	3.00	33	E970-P-_(E)	■	■	■	■	■
90°	0.04-0.10* / 0.10-0.30**	1.20	2.00	3.00	33	E990-P-_(E)	■	■	■	■	■

* tous les 0.01 mm
alle 0.01 mm
every 0.01 mm

** tous les 0.05 mm
alle 0.05 mm
every 0.05 mm

Paramètres de coupe indicatif
Empfohlene Schnittwerte
Standard machining data

Micro-forets et centreurs
Mikrobohrer und Zentrierbohrer
Micro drills and centering drills

Point angle	λ	L2	D1	D2	Type	Page
60°	25°	Div.	Ø 2.00 - 6.00	D1 = D2	2680-60	14.107
90°	25°	Div.	Ø 0.50 - 20.00	Ø 2.0 - 20.0	2680-90	14.108
90°	25°	Div.	Ø 2.00 - 16.00	D1 = D2	1680-90	14.108
120°	25°	Div.	Ø 0.50 - 20.00	Ø 2.0 - 20.0	2680-120	14.109
120°	25°	Div.	Ø 2.00 - 12.00	D1 = D2	1680-120	14.109

Micro-forets de préperçage
Mikro Pilotbohrer
Micro pilot drill

Z	Point angle	λ	L2	D1	D2	Type	Page
Z2	90°	25° - 32°	Div.	Ø 0.50 - 3.00	Ø2h5 Ø3h4	2690	14.110
Z2	130°	30°	~ 2 x D1	Ø 0.10 - 2.00	Ø3h6	2020	14.115

Micro-forets avec affûtage à facettes
Mikrobohrer mit Facettenschliff
Micro drills with faceted drill point

Z	Point angle	λ	L2	D1	D2	Type	Page
Z2	118°	25°	~ 5-10 x D1	Ø 0.50 - 6.00	D1 = D2	1010	14.111
Z2	118°	25°/35°	~ 5-10 x D1	Ø 0.50 - 6.00	D1 = D2	2010	14.112
Z2	120°	30°	~ 2 x D1	Ø 0.80 - 2.00	Ø 2h6	2011	14.113
Z2	120°	24°	~ 3 x D1	Ø 0.50 - 2.40	Ø 1.5 - 3.0 h6	2012	14.113
Z2	120°	35°	~ 8 x D1	Ø 0.40 - 1.90	Ø 1.0 - 2.0 h6	2013	14.114
Z2	120°	30°	~ 12 x D1	Ø 0.50 - 1.95	Ø 1.5 - 2.0 h6	2014	14.114
Z2	130°	35°	6 x D1	Ø 0.10 - 3.00	Ø3h6	2023	14.117
Z2	130°	35°	12 x D1	Ø 0.20 - 2.00	Ø3h6	2026	14.120
Z3	140°	35°	5 x D1	Ø 0.20 - 2.99	Ø3h6	2030	14.122

Forets à centrer NC

NC-Zentrierbohrer

NC centering drills

Paramètres de coupe indicatifs

Empfohlene Schnittwerte

Standard machining data

Matière Werkstoff Material	VC	f	Z	TAIN	STF
	[m/min]	[mm]			
Acier de décolletage Automatenstahl Free-cutting steel (P)	60	D1/55	**	***	***
Acier Stahl < 600 N/mm ² (P)	55	D1/55	**	***	***
Acier Stahl < 800 N/mm ² (P)	55	D1/55	**	***	***
Acier Stahl > 800 N/mm ² (P)	55	D1/55	**	***	***
Acier trempé Gehärteter Stahl -55HRC (H)	10	D1/100	-	***	***
Acier trempé Gehärteter Stahl +55HRC (H)	-	-	-	-	-
Inox Rostfreistahl Stainless steel (M)	30	D1/85	**	***	***
Aluminium (N)	100 - 180	D1/50	***	**	**
Cuivre, laiton, bronze Kupfer, Messing, Bronze Copper, brass, bronze (N)	60 - 90	D1/60	***	**	**
Matière synthétique Synthetisches Material Synthetic material (N)	350 - 700	D1/60	***	**	**
Métaux précieux Edelmetalle Precious metals (N)	50 - 80	D1/100	***	**	**
Titane Titan Titanium (S)	30	D1/115	**	***	***
Alliage de nickel Nickel-Legierung Nickel alloy (S)	15 - 20	D1/120	**	***	***
Matière exotique Exotisches material Exotic material (O)	10	D1/100	**	***	***

Avec revêtement, augmenter les valeurs de 20-30%

Mit Beschichtung, Daten um 20-30% erhöhen

With coating, increase data by 20-30%

* Bien / Gut / Good

** Très bien / Sehr Gut / Very good

*** Excellent / Ausgezeichnet / Excellent

Matière Werkstoff Material		VC	f	Débouillage
		(m/min)	(mm)	
Acier de décolletage Automatenstahl Free-cutting steel	P	60 - 90	D1/70	1.5xØ
Acier Stahl Steel	< 600 N/mm ² P	50 - 80	D1/70	1.5xØ
Acier Stahl Steel	< 800 N/mm ² P	50 - 80	D1/70	1.5xØ
Acier Stahl Steel	> 800 N/mm ² P	50 - 80	D1/70	1.5xØ
Acier trempé Gehärteter Stahl Hardened steel	-55HRC H	-	-	-
Acier trempé Gehärteter Stahl Hardened steel	+55HRC H	-	-	-
Inox Rostfreistahl Stainless steel	M	20 - 30	D1/70	3xØ
Aluminium	N	100 - 180	D1/40	2xØ
Cuivre, laiton, bronze Kupfer, Messing, Bronze Copper, brass, bronze	N	50 - 85	D1/120	1xØ
Matière synthétique Synthetisches Material Synthetic material	N	350 - 750	D1/40	2xØ
Métaux précieux Edelmetalle Precious metals	N	60 - 90	D1/100	0.85xØ
Titane Titan Titanium	S	20 - 40	D1/120	1.3xØ
Alliage de nickel Nickel-Legierung Nickel alloy	S	20	D1/120	1xØ
Matière exotique Exotisches material Exotic material	O	5 - 10	D1/100	1xØ

Avec revêtement, augmenter les valeurs de 20-30%

Mit Beschichtung, Daten um 20-30% erhöhen

With coating, increase data by 20-30%

Centreurs NC

NC-Zentrierbohrer

NC centering drills

2680-60

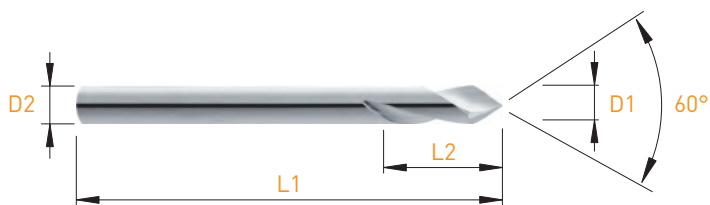

MD VHM HM	λ^{25°	60°
-----------------	----------------------	-----

D1 h6	L2	D2 h5	L1	Art. N°	Z	TiAlN	STF
2.00	8.00	2.00	39	2680-2.00-60	■	■	■
3.00	10.00	3.00	39	2680-3.00-60	■	■	■
4.00	12.00	4.00	50	2680-4.00-60	■	■	■
5.00	14.00	5.00	50	2680-5.00-60	■	■	■
6.00	16.00	6.00	50	2680-6.00-60	■	■	■

MICRO-LINE

Centreurs NC
 NC-Zentrierbohrer
 NC centering drills

1680-90° / 2680-90°

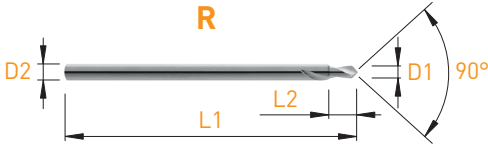

MD VHM HM	λ		R					
	25°	90°	D1 h ₆	L2	D2 h ₅	L1	Art. N°	Z
			0.50	1.50	2.00	39	2680-0.50-90	■
			0.60	1.50	2.00	39	2680-0.60-90	■
			0.70	1.50	2.00	39	2680-0.70-90	■
			0.80	1.50	2.00	39	2680-0.80-90	■
			0.90	1.50	2.00	39	2680-0.90-90	■
			1.00	3.00	2.00	39	2680-1.00-90	■
			1.10	3.00	2.00	39	2680-1.10-90	■
			1.20	3.00	2.00	39	2680-1.20-90	■
			1.30	3.00	2.00	39	2680-1.30-90	■
			1.40	3.00	2.00	39	2680-1.40-90	■
			1.50	4.00	2.00	39	2680-1.50-90	■
			1.60	4.00	2.00	39	2680-1.60-90	■
			1.70	4.00	2.00	39	2680-1.70-90	■
			1.80	4.00	2.00	39	2680-1.80-90	■
			1.90	4.00	2.00	39	2680-1.90-90	■

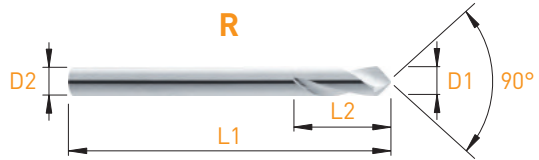

MD VHM HM	λ		L				R				HSS	R		
	25°	90°	D1	L2	D2 h ₆	L1	Art. N°	Z	Art. N°	Z		TiAIN	STF	Art. N°
			2.00	8.00	2.00	39	1680-2.00-90	■	2680-2.00-90	■	■	■	-	
			2.50	8.00	2.50	39	1680-2.50-90	■	2680-2.50-90	■	■	■	-	
			3.00	10.00	3.00	39	1680-3.00-90	■	2680-3.00-90	■	■	■	2680-3.00-90-HSS	■
			4.00	12.00	4.00	50	1680-4.00-90	■	2680-4.00-90	■	■	■	2680-4.00-90-HSS	■
			5.00	15.00	5.00	50	1680-5.00-90	■	2680-5.00-90	■	■	■	2680-5.00-90-HSS	■
			6.00	16.00	6.00	57	1680-6.00-90	■	2680-6.00-90	■	■	■	2680-6.00-90-HSS	■
			8.00	20.00	8.00	63	1680-8.00-90	■	2680-8.00-90	■			2680-8.00-90-HSS	■
			10.00	22.00	10.00	72	1680-10.00-90	■	2680-10.00-90	■			2680-10.00-90-HSS	■
			12.00	24.00	12.00	73	1680-12.00-90	■	2680-12.00-90	■			2680-12.00-90-HSS	■
			16.00	26.00	16.00	82	1680-16.00-90	■	2680-16.00-90	■			-	
			20.00	30.00	20.00	92	-		2680-20.00-90	■			-	

Centreurs NC
 NC-Zentrierbohrer
 NC centering drills

1680-120° / 2680-120°

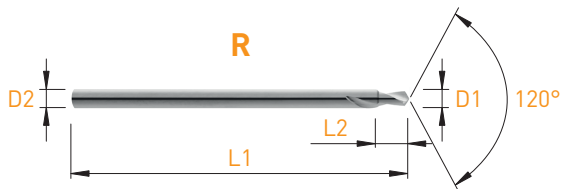

MD VHM HM	λ		R		
	25°	120°			
D1 h6	L2	D2 h5	L1	Art. N°	Z
0.50	1.50	2.00	39	2680-0.50-120	■
0.60	1.50	2.00	39	2680-0.60-120	■
0.70	1.50	2.00	39	2680-0.70-120	■
0.80	1.50	2.00	39	2680-0.80-120	■
0.90	1.50	2.00	39	2680-0.90-120	■
1.00	3.00	2.00	39	2680-1.00-120	■
1.10	3.00	2.00	39	2680-1.10-120	■
1.20	3.00	2.00	39	2680-1.20-120	■
1.30	3.00	2.00	39	2680-1.30-120	■
1.40	3.00	2.00	39	2680-1.40-120	■
1.50	4.00	2.00	39	2680-1.50-120	■
1.60	4.00	2.00	39	2680-1.60-120	■
1.70	4.00	2.00	39	2680-1.70-120	■
1.80	4.00	2.00	39	2680-1.80-120	■
1.90	4.00	2.00	39	2680-1.90-120	■

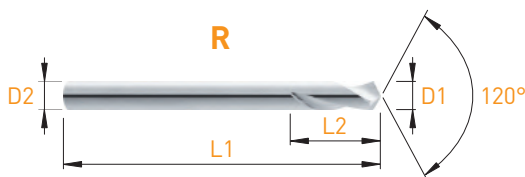

MD VHM HM	λ		L		R				
	25°	120°							
D1	L2	D2 h6	L1	Art. N°	Z	Art. N°	Z	TiAlN	STF
2.00	8.00	2.00	39	1680-2.00-120	■	2680-2.00-120	■	■	■
2.50	8.00	2.50	39	1680-2.50-120	■	2680-2.50-120	■	■	■
3.00	10.00	3.00	39	1680-3.00-120	■	2680-3.00-120	■	■	■
4.00	12.00	4.00	50	1680-4.00-120	■	2680-4.00-120	■	■	■
5.00	15.00	5.00	50	1680-5.00-120	■	2680-5.00-120	■	■	■
6.00	16.00	6.00	57	1680-6.00-120	■	2680-6.00-120	■	■	■
8.00	20.00	8.00	63	1680-8.00-120	■	2680-8.00-120	■		
10.00	22.00	10.00	72	1680-10.00-120	■	2680-10.00-120	■		
12.00	24.00	12.00	73	1680-12.00-120	■	2680-12.00-120	■		
16.00	26.00	16.00	82	-		2680-16.00-120	■		
20.00	30.00	20.00	92	-		2680-20.00-120	■		

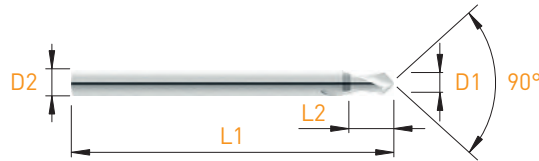

MD VHM HM	*			Art. N°	Z	TiAlN	STF
	λ 32°	λ 25°	90°				
D1 h5	L2	D2 h5	L1				
0.50*	2.50	2.00	39	2690-0.50	■		
0.60*	2.50	2.00	39	2690-0.60	■		
0.70*	2.50	2.00	39	2690-0.70	■		
0.80*	2.50	2.00	39	2690-0.80	■		
0.90*	2.50	2.00	39	2690-0.90	■		
1.00	3.00	2.00	39	2690-1.00	■		
1.10	3.00	2.00	39	2690-1.10	■		
1.20	3.00	2.00	39	2690-1.20	■		
1.30	3.00	2.00	39	2690-1.30	■		
1.40	3.00	2.00	39	2690-1.40	■		
1.50	3.50	2.00	39	2690-1.50	■		
1.60	3.50	2.00	39	2690-1.60	■		
1.70	3.50	2.00	39	2690-1.70	■		
1.80	3.50	2.00	39	2690-1.80	■		
1.90	3.50	2.00	39	2690-1.90	■		
2.00	-	2.00	39	2690-2.00	■	■	■
2.10	4.00	3.00	39	2690-2.10	■	■	■
2.20	4.00	3.00	39	2690-2.20	■	■	■
2.30	4.00	3.00	39	2690-2.30	■	■	■
2.40	4.00	3.00	39	2690-2.40	■	■	■
2.50	4.00	3.00	39	2690-2.50	■	■	■
2.60	4.00	3.00	39	2690-2.60	■	■	■
2.70	4.00	3.00	39	2690-2.70	■	■	■
2.80	4.00	3.00	39	2690-2.80	■	■	■
2.90	4.00	3.00	39	2690-2.90	■	■	■
3.00	-	3.00	50	2690-3.00	■	■	■

Forets cylindriques

Zylindrische Bohrer

Cylindrical drills

Coupe à gauche

Linksschneidend

Left hand cut

1010

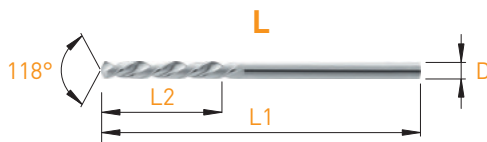

MD
VHM
HM

λ 25°

Z=2



D h6	L1	L2	Art. N°	Z
0.50	30	5.00	1010-0.50	■
0.55	30	5.00	1010-0.55	■
0.60	30	5.00	1010-0.60	■
0.65	30	6.00	1010-0.65	■
0.70	30	6.00	1010-0.70	■
0.75	30	8.00	1010-0.75	■
0.80	30	8.00	1010-0.80	■
0.85	30	9.00	1010-0.85	■
0.90	30	9.00	1010-0.90	■
0.95	30	10.00	1010-0.95	■
1.00	30	10.00	1010-1.00	■
1.05	30	10.00	1010-1.05	■
1.10	30	10.00	1010-1.10	■
1.15	30	12.00	1010-1.15	■
1.20	30	12.00	1010-1.20	■
1.25	30	12.00	1010-1.25	■
1.30	30	12.00	1010-1.30	■
1.35	30	12.00	1010-1.35	■
1.40	30	12.00	1010-1.40	■
1.45	30	12.00	1010-1.45	■
1.50	30	12.00	1010-1.50	■
1.55	40	16.00	1010-1.55	■
1.60	40	16.00	1010-1.60	■
1.65	40	16.00	1010-1.65	■
1.70	40	16.00	1010-1.70	■
1.75	40	16.00	1010-1.75	■
1.80	40	16.00	1010-1.80	■
1.85	40	16.00	1010-1.85	■
1.90	40	16.00	1010-1.90	■
1.95	40	16.00	1010-1.95	■
2.00	40	16.00	1010-2.00	■
2.05	40	18.00	1010-2.05	■
2.10	40	18.00	1010-2.10	■
2.15	40	18.00	1010-2.15	■
2.20	40	18.00	1010-2.20	■
2.25	40	18.00	1010-2.25	■
2.30	40	18.00	1010-2.30	■
2.35	40	18.00	1010-2.35	■
2.40	40	18.00	1010-2.40	■
2.45	40	18.00	1010-2.45	■
2.50	40	18.00	1010-2.50	■

D h6	L1	L2	Art. N°	Z
2.55	45	18.00	1010-2.55	■
2.60	45	18.00	1010-2.60	■
2.65	45	18.00	1010-2.65	■
2.70	45	18.00	1010-2.70	■
2.75	45	18.00	1010-2.75	■
2.80	45	18.00	1010-2.80	■
2.85	45	18.00	1010-2.85	■
2.90	45	18.00	1010-2.90	■
2.95	45	18.00	1010-2.95	■
3.00	45	18.00	1010-3.00	■
3.10	50	20.00	1010-3.10	■
3.20	50	20.00	1010-3.20	■
3.30	50	20.00	1010-3.30	■
3.40	50	20.00	1010-3.40	■
3.50	50	20.00	1010-3.50	■
3.60	50	20.00	1010-3.60	■
3.70	50	20.00	1010-3.70	■
3.80	50	20.00	1010-3.80	■
3.90	50	20.00	1010-3.90	■
4.00	50	20.00	1010-4.00	■
4.10	50	25.00	1010-4.10	■
4.20	50	25.00	1010-4.20	■
4.30	50	25.00	1010-4.30	■
4.40	50	25.00	1010-4.40	■
4.50	50	25.00	1010-4.50	■
4.60	50	25.00	1010-4.60	■
4.70	50	25.00	1010-4.70	■
4.80	50	25.00	1010-4.80	■
4.90	50	25.00	1010-4.90	■
5.00	50	25.00	1010-5.00	■
5.10	50	25.00	1010-5.10	■
5.20	50	25.00	1010-5.20	■
5.30	50	25.00	1010-5.30	■
5.40	50	25.00	1010-5.40	■
5.50	50	25.00	1010-5.50	■
5.60	50	25.00	1010-5.60	■
5.70	50	25.00	1010-5.70	■
5.80	50	25.00	1010-5.80	■
5.90	50	25.00	1010-5.90	■
6.00	50	25.00	1010-6.00	■

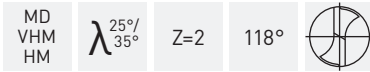
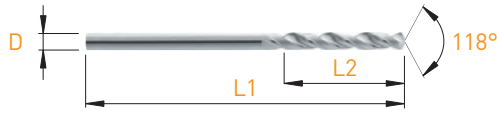

D h6	L1	L2	Art. N°	Z
0.50	30	5.00	2010-0.50	■
0.55	30	5.00	2010-0.55	■
0.60	30	5.00	2010-0.60	■
0.65	30	6.00	2010-0.65	■
0.70	30	6.00	2010-0.70	■
0.75	30	8.00	2010-0.75	■
0.80	30	8.00	2010-0.80	■
0.85	30	9.00	2010-0.85	■
0.90	30	9.00	2010-0.90	■
0.95	30	10.00	2010-0.95	■
1.00	30	10.00	2010-1.00	■
1.05	30	10.00	2010-1.05	■
1.10	30	10.00	2010-1.10	■
1.15	30	12.00	2010-1.15	■
1.20	30	12.00	2010-1.20	■
1.25	30	12.00	2010-1.25	■
1.30	30	12.00	2010-1.30	■
1.35	30	12.00	2010-1.35	■
1.40	30	12.00	2010-1.40	■
1.45	30	12.00	2010-1.45	■
1.50	30	12.00	2010-1.50	■
1.55	40	16.00	2010-1.55	■
1.60	40	16.00	2010-1.60	■
1.65	40	16.00	2010-1.65	■
1.70	40	16.00	2010-1.70	■
1.75	40	16.00	2010-1.75	■
1.80	40	16.00	2010-1.80	■
1.85	40	16.00	2010-1.85	■
1.90	40	16.00	2010-1.90	■
1.95	40	16.00	2010-1.95	■
2.00	40	16.00	2010-2.00	■
2.05	40	18.00	2010-2.05	■
2.10	40	18.00	2010-2.10	■
2.15	40	18.00	2010-2.15	■
2.20	40	18.00	2010-2.20	■
2.25	40	18.00	2010-2.25	■
2.30	40	18.00	2010-2.30	■
2.35	40	18.00	2010-2.35	■
2.40	40	18.00	2010-2.40	■
2.45	40	18.00	2010-2.45	■
2.50	40	18.00	2010-2.50	■

D h6	L1	L2	Art. N°	Z
2.55	45	18.00	2010-2.55	■
2.60	45	18.00	2010-2.60	■
2.65	45	18.00	2010-2.65	■
2.70	45	18.00	2010-2.70	■
2.75	45	18.00	2010-2.75	■
2.80	45	18.00	2010-2.80	■
2.85	45	18.00	2010-2.85	■
2.90	45	18.00	2010-2.90	■
2.95	45	18.00	2010-2.95	■
3.00	45	18.00	2010-3.00	■
3.10	50	20.00	2010-3.10	■
3.20	50	20.00	2010-3.20	■
3.30	50	20.00	2010-3.30	■
3.40	50	20.00	2010-3.40	■
3.50	50	20.00	2010-3.50	■
3.60	50	20.00	2010-3.60	■
3.70	50	20.00	2010-3.70	■
3.80	50	20.00	2010-3.80	■
3.90	50	20.00	2010-3.90	■
4.00	50	20.00	2010-4.00	■
4.10	50	25.00	2010-4.10	■
4.20	50	25.00	2010-4.20	■
4.30	50	25.00	2010-4.30	■
4.40	50	25.00	2010-4.40	■
4.50	50	25.00	2010-4.50	■
4.60	50	25.00	2010-4.60	■
4.70	50	25.00	2010-4.70	■
4.80	50	25.00	2010-4.80	■
4.90	50	25.00	2010-4.90	■
5.00	50	25.00	2010-5.00	■
5.10	50	25.00	2010-5.10	■
5.20	50	25.00	2010-5.20	■
5.30	50	25.00	2010-5.30	■
5.40	50	25.00	2010-5.40	■
5.50	50	25.00	2010-5.50	■
5.60	50	25.00	2010-5.60	■
5.70	50	25.00	2010-5.70	■
5.80	50	25.00	2010-5.80	■
5.90	50	25.00	2010-5.90	■
6.00	50	25.00	2010-6.00	■

Micro-forets

Mikrobohrer

Micro drills

2011 / 2012

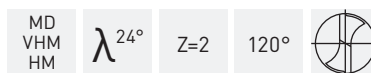
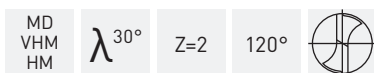
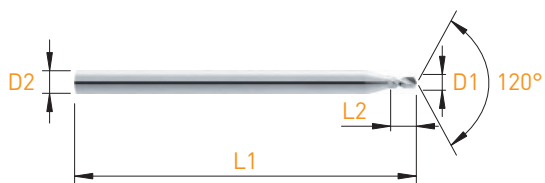

D1 h6	L2	D2 h6	L1	Art. N°	Z
0.80	2.50	2.00	30	2011-0.80	■
0.90	2.50	2.00	30	2011-0.90	■
1.00	2.50	2.00	30	2011-1.00	■
1.10	2.50	2.00	30	2011-1.10	■
1.20	2.50	2.00	30	2011-1.20	■
1.30	2.50	2.00	30	2011-1.30	■
1.40	2.50	2.00	30	2011-1.40	■
1.50	2.50	2.00	30	2011-1.50	■
2.00	2.50	2.00	30	2011-2.00	■

D1 h6	L2	D2 h6	L1	Art. N°	Z
0.50	1.70	1.50	30	2012-0.50	■
0.55	1.90	1.50	30	2012-0.55	■
0.60	1.90	1.50	30	2012-0.60	■
0.65	1.90	1.50	30	2012-0.65	■
0.70	2.40	1.50	30	2012-0.70	■
0.75	2.40	1.50	30	2012-0.75	■
0.80	2.60	1.50	30	2012-0.80	■
0.85	2.60	1.50	30	2012-0.85	■
0.90	3.00	1.50	30	2012-0.90	■
0.95	3.00	1.50	30	2012-0.95	■
1.00	3.40	1.50	30	2012-1.00	■
1.10	3.80	1.50	30	2012-1.10	■
1.20	4.20	1.50	30	2012-1.20	■
1.30	4.20	1.50	30	2012-1.30	■
1.40	4.70	1.50	30	2012-1.40	■
1.50	4.70	2.00	38	2012-1.50	■
1.60	5.40	2.00	38	2012-1.60	■
1.70	5.40	2.00	38	2012-1.70	■
1.80	6.50	2.00	38	2012-1.80	■
1.90	6.50	2.00	38	2012-1.90	■
2.00	6.50	3.00	38	2012-2.00	■
2.10	6.50	3.00	38	2012-2.10	■
2.20	6.50	3.00	38	2012-2.20	■
2.30	6.50	3.00	38	2012-2.30	■
2.40	6.50	3.00	38	2012-2.40	■

MICRO-LINE

Micro-forets

Mikrobohrer

Micro drills

2013 / 2014

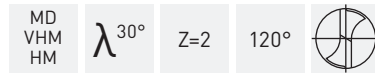
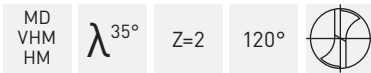
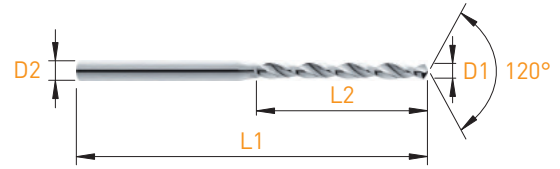
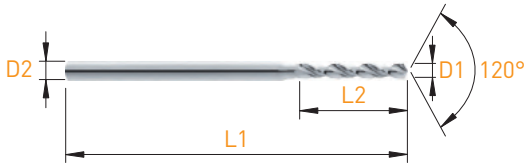

D1 h6	L2	D2 h6	L1	Art. N°	Z
0.40	3.60	1.00	25	2013-0.40	■
0.45	3.60	1.00	25	2013-0.45	■
0.50	4.00	1.00	25	2013-0.50	■
0.55	4.50	1.00	25	2013-0.55	■
0.60	4.50	1.50	30	2013-0.60	■
0.65	5.00	1.50	30	2013-0.65	■
0.70	5.60	1.50	30	2013-0.70	■
0.75	5.60	1.50	30	2013-0.75	■
0.80	6.30	1.50	30	2013-0.80	■
0.85	6.30	1.50	30	2013-0.85	■
0.90	7.10	1.50	30	2013-0.90	■
0.95	7.10	1.50	30	2013-0.95	■
1.00	8.00	1.50	30	2013-1.00	■
1.05	8.00	1.50	30	2013-1.05	■
1.10	9.00	1.50	30	2013-1.10	■
1.15	9.00	1.50	30	2013-1.15	■
1.20	10.00	1.50	30	2013-1.20	■
1.25	10.00	1.50	30	2013-1.25	■
1.30	10.00	1.50	30	2013-1.30	■
1.35	11.20	1.50	30	2013-1.35	■
1.40	11.20	1.50	30	2013-1.40	■
1.45	11.20	1.50	30	2013-1.45	■
1.50	12.00	2.00	38	2013-1.50	■
1.60	12.00	2.00	38	2013-1.60	■
1.70	12.00	2.00	38	2013-1.70	■
1.80	12.00	2.00	38	2013-1.80	■
1.90	12.00	2.00	38	2013-1.90	■

D1 h6	L2	D2 h6	L1	Art. N°	Z
0.50	6.00	1.50	30	2014-0.50	■
0.55	6.50	1.50	30	2014-0.55	■
0.60	6.50	1.50	30	2014-0.60	■
0.65	7.50	1.50	30	2014-0.65	■
0.70	8.50	1.50	30	2014-0.70	■
0.75	8.50	1.50	30	2014-0.75	■
0.80	9.50	1.50	30	2014-0.80	■
0.85	9.50	1.50	30	2014-0.85	■
0.90	10.50	1.50	30	2014-0.90	■
0.95	10.50	1.50	30	2014-0.95	■
1.00	12.00	1.50	38	2014-1.00	■
1.05	12.00	1.50	38	2014-1.05	■
1.10	13.50	1.50	38	2014-1.10	■
1.15	13.50	1.50	38	2014-1.15	■
1.20	15.00	1.50	38	2014-1.20	■
1.25	15.00	1.50	38	2014-1.25	■
1.30	17.00	1.50	38	2014-1.30	■
1.35	17.00	1.50	38	2014-1.35	■
1.40	17.00	1.50	38	2014-1.40	■
1.45	17.00	1.50	38	2014-1.45	■
1.50	18.00	2.00	38	2014-1.50	■
1.55	18.00	2.00	38	2014-1.55	■
1.60	18.00	2.00	38	2014-1.60	■
1.65	18.00	2.00	38	2014-1.65	■
1.70	18.00	2.00	38	2014-1.70	■
1.75	18.00	2.00	38	2014-1.75	■
1.80	18.00	2.00	38	2014-1.80	■
1.85	18.00	2.00	38	2014-1.85	■
1.90	18.00	2.00	38	2014-1.90	■
1.95	18.00	2.00	38	2014-1.95	■

Micro-forets de préperçage

Mikro Pilotbohrer

Micro pilot drill

Ø 0.10 - Ø 0.99 mm

2020

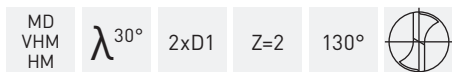
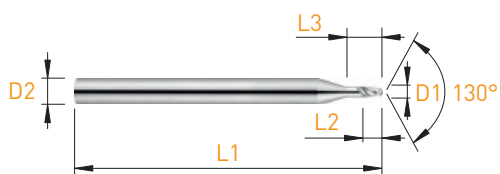

D1 +0.005 / 0	L2	L3	L1	D2 h6	Art. N°	z
0.10	0.35	0.55	38	3.00	2020-0.10	■
0.11	0.35	0.55	38	3.00	2020-0.11	■
0.12	0.35	0.55	38	3.00	2020-0.12	■
0.13	0.40	0.60	38	3.00	2020-0.13	■
0.14	0.40	0.60	38	3.00	2020-0.14	■
0.15	0.40	0.60	38	3.00	2020-0.15	■
0.16	0.40	0.60	38	3.00	2020-0.16	■
0.17	0.50	0.70	38	3.00	2020-0.17	■
0.18	0.50	0.70	38	3.00	2020-0.18	■
0.19	0.50	0.70	38	3.00	2020-0.19	■
0.20	0.55	0.75	38	3.00	2020-0.20	■
0.21	0.55	0.75	38	3.00	2020-0.21	■
0.22	0.60	0.80	38	3.00	2020-0.22	■
0.23	0.60	0.80	38	3.00	2020-0.23	■
0.24	0.60	0.80	38	3.00	2020-0.24	■
0.25	0.70	0.90	38	3.00	2020-0.25	■
0.26	0.70	0.90	38	3.00	2020-0.26	■
0.27	0.70	0.90	38	3.00	2020-0.27	■
0.28	0.80	1.00	38	3.00	2020-0.28	■
0.29	0.80	1.00	38	3.00	2020-0.29	■
0.30	0.90	1.20	38	3.00	2020-0.30	■
0.31	0.90	1.20	38	3.00	2020-0.31	■
0.32	0.90	1.20	38	3.00	2020-0.32	■
0.33	0.90	1.20	38	3.00	2020-0.33	■
0.34	0.90	1.35	38	3.00	2020-0.34	■
0.35	0.90	1.35	38	3.00	2020-0.35	■
0.36	0.95	1.35	38	3.00	2020-0.36	■
0.37	0.95	1.35	38	3.00	2020-0.37	■
0.38	0.95	1.50	38	3.00	2020-0.38	■
0.39	0.95	1.50	38	3.00	2020-0.39	■
0.40	0.80	1.60	38	3.00	2020-0.40	■
0.41	0.82	1.60	38	3.00	2020-0.41	■
0.42	0.84	1.60	38	3.00	2020-0.42	■
0.43	0.86	1.60	38	3.00	2020-0.43	■
0.44	0.88	1.60	38	3.00	2020-0.44	■
0.45	0.90	1.60	38	3.00	2020-0.45	■
0.46	0.92	1.70	38	3.00	2020-0.46	■
0.47	0.94	1.70	38	3.00	2020-0.47	■
0.48	0.96	1.70	38	3.00	2020-0.48	■

D1 +0.005 / 0	L2	L3	L1	D2 h6	Art. N°	z
0.49	0.98	1.70	38	3.00	2020-0.49	■
0.50	1.00	1.70	38	3.00	2020-0.50	■
0.51	1.02	1.80	38	3.00	2020-0.51	■
0.52	1.04	1.80	38	3.00	2020-0.52	■
0.53	1.06	1.80	38	3.00	2020-0.53	■
0.54	1.08	1.80	38	3.00	2020-0.54	■
0.55	1.10	1.80	38	3.00	2020-0.55	■
0.56	1.12	1.90	38	3.00	2020-0.56	■
0.57	1.14	1.90	38	3.00	2020-0.57	■
0.58	1.16	1.90	38	3.00	2020-0.58	■
0.59	1.18	1.90	38	3.00	2020-0.59	■
0.60	1.20	1.90	38	3.00	2020-0.60	■
0.61	1.22	2.00	38	3.00	2020-0.61	■
0.62	1.24	2.00	38	3.00	2020-0.62	■
0.63	1.26	2.00	38	3.00	2020-0.63	■
0.64	1.28	2.00	38	3.00	2020-0.64	■
0.65	1.30	2.00	38	3.00	2020-0.65	■
0.66	1.32	2.10	38	3.00	2020-0.66	■
0.67	1.34	2.10	38	3.00	2020-0.67	■
0.68	1.36	2.10	38	3.00	2020-0.68	■
0.69	1.38	2.10	38	3.00	2020-0.69	■
0.70	1.40	2.10	38	3.00	2020-0.70	■
0.71	1.42	2.20	38	3.00	2020-0.71	■
0.72	1.44	2.20	38	3.00	2020-0.72	■
0.73	1.46	2.20	38	3.00	2020-0.73	■
0.74	1.48	2.20	38	3.00	2020-0.74	■
0.75	1.50	2.20	38	3.00	2020-0.75	■
0.76	1.52	2.30	38	3.00	2020-0.76	■
0.77	1.54	2.30	38	3.00	2020-0.77	■
0.78	1.56	2.30	38	3.00	2020-0.78	■
0.79	1.58	2.30	38	3.00	2020-0.79	■
0.80	1.60	2.30	38	3.00	2020-0.80	■
0.81	1.62	2.40	38	3.00	2020-0.81	■
0.82	1.64	2.40	38	3.00	2020-0.82	■
0.83	1.66	2.40	38	3.00	2020-0.83	■
0.84	1.68	2.40	38	3.00	2020-0.84	■
0.85	1.70	2.40	38	3.00	2020-0.85	■
0.86	1.72	2.50	38	3.00	2020-0.86	■
0.87	1.74	2.50	38	3.00	2020-0.87	■
0.88	1.76	2.50	38	3.00	2020-0.88	■
0.89	1.78	2.50	38	3.00	2020-0.89	■
0.90	1.80	2.50	38	3.00	2020-0.90	■
0.91	1.82	2.60	38	3.00	2020-0.91	■
0.92	1.84	2.60	38	3.00	2020-0.92	■
0.93	1.86	2.60	38	3.00	2020-0.93	■
0.94	1.88	2.60	38	3.00	2020-0.94	■
0.95	1.90	2.60	38	3.00	2020-0.95	■
0.96	1.92	2.70	38	3.00	2020-0.96	■
0.97	1.94	2.70	38	3.00	2020-0.97	■
0.98	1.96	2.70	38	3.00	2020-0.98	■
0.99	1.98	2.70	38	3.00	2020-0.99	■

D1 +0.005/0	L2	L3	L1	D2 h ₆	Art. N°	Z
1.00	2.00	2.70	38	3.00	2020-1.00	■
1.01	2.02	3.50	38	3.00	2020-1.01	■
1.02	2.04	3.50	38	3.00	2020-1.02	■
1.03	2.06	3.50	38	3.00	2020-1.03	■
1.04	2.08	3.50	38	3.00	2020-1.04	■
1.05	2.10	3.50	38	3.00	2020-1.05	■
1.06	2.12	3.60	38	3.00	2020-1.06	■
1.07	2.14	3.60	38	3.00	2020-1.07	■
1.08	2.16	3.60	38	3.00	2020-1.08	■
1.09	2.18	3.60	38	3.00	2020-1.09	■
1.10	2.20	3.60	38	3.00	2020-1.10	■
1.11	2.22	3.70	38	3.00	2020-1.11	■
1.12	2.24	3.70	38	3.00	2020-1.12	■
1.13	2.26	3.70	38	3.00	2020-1.13	■
1.14	2.28	3.70	38	3.00	2020-1.14	■
1.15	2.30	3.70	38	3.00	2020-1.15	■
1.16	2.32	3.80	38	3.00	2020-1.16	■
1.17	2.34	3.80	38	3.00	2020-1.17	■
1.18	2.36	3.80	38	3.00	2020-1.18	■
1.19	2.38	3.80	38	3.00	2020-1.19	■
1.20	2.40	3.80	38	3.00	2020-1.20	■
1.21	2.42	4.20	38	3.00	2020-1.21	■
1.22	2.44	4.20	38	3.00	2020-1.22	■
1.23	2.46	4.20	38	3.00	2020-1.23	■
1.24	2.48	4.20	38	3.00	2020-1.24	■
1.25	2.50	4.20	38	3.00	2020-1.25	■
1.26	2.52	4.30	38	3.00	2020-1.26	■
1.27	2.54	4.30	38	3.00	2020-1.27	■
1.28	2.56	4.30	38	3.00	2020-1.28	■
1.29	2.58	4.30	38	3.00	2020-1.29	■
1.30	2.60	4.30	38	3.00	2020-1.30	■
1.31	2.62	4.40	38	3.00	2020-1.31	■
1.32	2.64	4.40	38	3.00	2020-1.32	■
1.33	2.66	4.40	38	3.00	2020-1.33	■
1.34	2.68	4.40	38	3.00	2020-1.34	■
1.35	2.70	4.40	38	3.00	2020-1.35	■
1.36	2.72	4.50	38	3.00	2020-1.36	■
1.37	2.74	4.50	38	3.00	2020-1.37	■
1.38	2.76	4.50	38	3.00	2020-1.38	■
1.39	2.78	4.50	38	3.00	2020-1.39	■
1.40	2.80	4.50	38	3.00	2020-1.40	■
1.41	2.82	4.60	38	3.00	2020-1.41	■
1.42	2.84	4.60	38	3.00	2020-1.42	■
1.43	2.86	4.60	38	3.00	2020-1.43	■
1.44	2.88	4.60	38	3.00	2020-1.44	■
1.45	2.90	4.60	38	3.00	2020-1.45	■
1.46	2.92	4.70	38	3.00	2020-1.46	■
1.47	2.94	4.70	38	3.00	2020-1.47	■
1.48	2.96	4.70	38	3.00	2020-1.48	■
1.49	2.98	4.70	38	3.00	2020-1.49	■
1.50	3.00	4.70	38	3.00	2020-1.50	■

D1 +0.005/0	L2	L3	L1	D2 h ₆	Art. N°	Z
1.51	3.02	5.10	38	3.00	2020-1.51	■
1.52	3.04	5.10	38	3.00	2020-1.52	■
1.53	3.06	5.10	38	3.00	2020-1.53	■
1.54	3.08	5.10	38	3.00	2020-1.54	■
1.55	3.10	5.10	38	3.00	2020-1.55	■
1.56	3.12	5.20	38	3.00	2020-1.56	■
1.57	3.14	5.20	38	3.00	2020-1.57	■
1.58	3.16	5.20	38	3.00	2020-1.58	■
1.59	3.18	5.20	38	3.00	2020-1.59	■
1.60	3.20	5.20	38	3.00	2020-1.60	■
1.61	3.22	5.30	38	3.00	2020-1.61	■
1.62	3.24	5.30	38	3.00	2020-1.62	■
1.63	3.26	5.30	38	3.00	2020-1.63	■
1.64	3.28	5.30	38	3.00	2020-1.64	■
1.65	3.30	5.30	38	3.00	2020-1.65	■
1.66	3.32	5.40	38	3.00	2020-1.66	■
1.67	3.34	5.40	38	3.00	2020-1.67	■
1.68	3.36	5.40	38	3.00	2020-1.68	■
1.69	3.38	5.40	38	3.00	2020-1.69	■
1.70	3.40	5.40	38	3.00	2020-1.70	■
1.71	3.42	5.50	38	3.00	2020-1.71	■
1.72	3.44	5.50	38	3.00	2020-1.72	■
1.73	3.46	5.50	38	3.00	2020-1.73	■
1.74	3.48	5.50	38	3.00	2020-1.74	■
1.75	3.50	5.50	38	3.00	2020-1.75	■
1.76	3.52	5.60	38	3.00	2020-1.76	■
1.77	3.54	5.60	38	3.00	2020-1.77	■
1.78	3.56	5.60	38	3.00	2020-1.78	■
1.79	3.58	5.60	38	3.00	2020-1.79	■
1.80	3.60	5.60	38	3.00	2020-1.80	■
1.81	3.62	5.70	38	3.00	2020-1.81	■
1.82	3.64	5.70	38	3.00	2020-1.82	■
1.83	3.66	5.70	38	3.00	2020-1.83	■
1.84	3.68	5.70	38	3.00	2020-1.84	■
1.85	3.70	5.70	38	3.00	2020-1.85	■
1.86	3.72	5.80	38	3.00	2020-1.86	■
1.87	3.74	5.80	38	3.00	2020-1.87	■
1.88	3.76	5.80	38	3.00	2020-1.88	■
1.89	3.78	5.80	38	3.00	2020-1.89	■
1.90	3.80	5.80	38	3.00	2020-1.90	■
1.91	3.82	5.90	38	3.00	2020-1.91	■
1.92	3.84	5.90	38	3.00	2020-1.92	■
1.93	3.86	5.90	38	3.00	2020-1.93	■
1.94	3.88	5.90	38	3.00	2020-1.94	■
1.95	3.90	5.90	38	3.00	2020-1.95	■
1.96	3.92	6.00	38	3.00	2020-1.96	■
1.97	3.94	6.00	38	3.00	2020-1.97	■
1.98	3.96	6.00	38	3.00	2020-1.98	■
1.99	3.98	6.00	38	3.00	2020-1.99	■
2.00	4.00	6.00	38	3.00	2020-2.00	■

Micro-forets

Mikrobohrer

Micro drills

Ø 0.10 - Ø 0.99 mm

2023

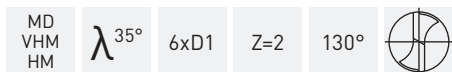
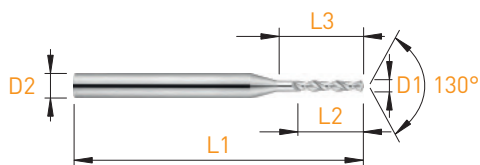

D1 0/-0.004	L2	L3	L1	D2 h6	Art. N°	z
0.10	0.50	0.70	38	3.00	2023-0.10	■
0.11	0.50	0.70	38	3.00	2023-0.11	■
0.12	0.50	0.70	38	3.00	2023-0.12	■
0.13	0.80	1.00	38	3.00	2023-0.13	■
0.14	0.80	1.00	38	3.00	2023-0.14	■
0.15	0.80	1.00	38	3.00	2023-0.15	■
0.16	1.10	1.40	38	3.00	2023-0.16	■
0.17	1.10	1.40	38	3.00	2023-0.17	■
0.18	1.10	1.40	38	3.00	2023-0.18	■
0.19	1.10	1.40	38	3.00	2023-0.19	■
0.20	1.50	1.80	38	3.00	2023-0.20	■
0.21	1.50	1.80	38	3.00	2023-0.21	■
0.22	1.50	1.80	38	3.00	2023-0.22	■
0.23	1.50	1.80	38	3.00	2023-0.23	■
0.24	1.50	1.80	38	3.00	2023-0.24	■
0.25	1.90	2.20	38	3.00	2023-0.25	■
0.26	1.90	2.20	38	3.00	2023-0.26	■
0.27	1.90	2.20	38	3.00	2023-0.27	■
0.28	1.90	2.20	38	3.00	2023-0.28	■
0.29	1.90	2.20	38	3.00	2023-0.29	■
0.30	1.80	2.40	38	3.00	2023-0.30	■
0.31	1.80	2.40	38	3.00	2023-0.31	■
0.32	1.80	2.40	38	3.00	2023-0.32	■
0.33	1.80	2.40	38	3.00	2023-0.33	■
0.34	1.80	2.40	38	3.00	2023-0.34	■
0.35	2.20	2.80	38	3.00	2023-0.35	■
0.36	2.20	2.80	38	3.00	2023-0.36	■
0.37	2.20	2.80	38	3.00	2023-0.37	■
0.38	2.20	2.80	38	3.00	2023-0.38	■
0.39	2.70	3.60	38	3.00	2023-0.39	■
0.40	2.70	3.60	38	3.00	2023-0.40	■
0.41	2.70	3.60	38	3.00	2023-0.41	■
0.42	2.70	3.60	38	3.00	2023-0.42	■
0.43	2.70	3.60	38	3.00	2023-0.43	■
0.44	2.70	3.60	38	3.00	2023-0.44	■
0.45	2.70	3.60	38	3.00	2023-0.45	■
0.46	2.70	3.60	38	3.00	2023-0.46	■
0.47	2.70	3.60	38	3.00	2023-0.47	■
0.48	2.70	3.60	38	3.00	2023-0.48	■

D1 0/-0.004	L2	L3	L1	D2 h6	Art. N°	z
0.49	3.20	4.00	38	3.00	2023-0.49	■
0.50	3.20	4.00	38	3.00	2023-0.50	■
0.51	3.20	4.00	38	3.00	2023-0.51	■
0.52	3.20	4.00	38	3.00	2023-0.52	■
0.53	3.20	4.00	38	3.00	2023-0.53	■
0.54	3.60	4.50	38	3.00	2023-0.54	■
0.55	3.60	4.50	38	3.00	2023-0.55	■
0.56	3.60	4.50	38	3.00	2023-0.56	■
0.57	3.60	4.50	38	3.00	2023-0.57	■
0.58	3.60	4.50	38	3.00	2023-0.58	■
0.59	3.60	4.50	38	3.00	2023-0.59	■
0.60	3.60	4.50	38	3.00	2023-0.60	■
0.61	3.90	5.00	38	3.00	2023-0.61	■
0.62	3.90	5.00	38	3.00	2023-0.62	■
0.63	3.90	5.00	38	3.00	2023-0.63	■
0.64	3.90	5.00	38	3.00	2023-0.64	■
0.65	3.90	5.00	38	3.00	2023-0.65	■
0.66	3.90	5.00	38	3.00	2023-0.66	■
0.67	3.90	5.00	38	3.00	2023-0.67	■
0.68	4.50	5.60	38	3.00	2023-0.68	■
0.69	4.50	5.60	38	3.00	2023-0.69	■
0.70	4.50	5.60	38	3.00	2023-0.70	■
0.71	4.50	5.60	38	3.00	2023-0.71	■
0.72	4.50	5.60	38	3.00	2023-0.72	■
0.73	4.50	5.60	38	3.00	2023-0.73	■
0.74	4.50	5.60	38	3.00	2023-0.74	■
0.75	4.50	5.60	38	3.00	2023-0.75	■
0.76	5.00	6.30	38	3.00	2023-0.76	■
0.77	5.00	6.30	38	3.00	2023-0.77	■
0.78	5.00	6.30	38	3.00	2023-0.78	■
0.79	5.00	6.30	38	3.00	2023-0.79	■
0.80	5.00	6.30	38	3.00	2023-0.80	■
0.81	5.00	6.30	38	3.00	2023-0.81	■
0.82	5.00	6.30	38	3.00	2023-0.82	■
0.83	5.00	6.30	38	3.00	2023-0.83	■
0.84	5.00	6.30	38	3.00	2023-0.84	■
0.85	5.00	6.30	38	3.00	2023-0.85	■
0.86	5.70	7.10	38	3.00	2023-0.86	■
0.87	5.70	7.10	38	3.00	2023-0.87	■
0.88	5.70	7.10	38	3.00	2023-0.88	■
0.89	5.70	7.10	38	3.00	2023-0.89	■
0.90	5.70	7.10	38	3.00	2023-0.90	■
0.91	5.70	7.10	38	3.00	2023-0.91	■
0.92	5.70	7.10	38	3.00	2023-0.92	■
0.93	5.70	7.10	38	3.00	2023-0.93	■
0.94	5.70	7.10	38	3.00	2023-0.94	■
0.95	5.70	7.10	38	3.00	2023-0.95	■
0.96	6.50	8.00	38	3.00	2023-0.96	■
0.97	6.50	8.00	38	3.00	2023-0.97	■
0.98	6.50	8.00	38	3.00	2023-0.98	■
0.99	6.50	8.00	38	3.00	2023-0.99	■

D1 0/-0.004	L2	L3	L1	D2 h6	Art. N°	Z
1.00	6.50	8.00	38	3.00	2023-1.00	■
1.01	6.50	8.00	38	3.00	2023-1.01	■
1.02	6.50	8.00	38	3.00	2023-1.02	■
1.03	6.50	8.00	38	3.00	2023-1.03	■
1.04	6.50	8.00	38	3.00	2023-1.04	■
1.05	6.50	8.00	38	3.00	2023-1.05	■
1.06	7.30	9.00	38	3.00	2023-1.06	■
1.07	7.30	9.00	38	3.00	2023-1.07	■
1.08	7.30	9.00	38	3.00	2023-1.08	■
1.09	7.30	9.00	38	3.00	2023-1.09	■
1.10	7.30	9.00	38	3.00	2023-1.10	■
1.11	7.30	9.00	38	3.00	2023-1.11	■
1.12	7.30	9.00	38	3.00	2023-1.12	■
1.13	7.30	9.00	38	3.00	2023-1.13	■
1.14	7.30	9.00	38	3.00	2023-1.14	■
1.15	7.30	9.00	38	3.00	2023-1.15	■
1.16	8.20	10.00	38	3.00	2023-1.16	■
1.17	8.20	10.00	38	3.00	2023-1.17	■
1.18	8.20	10.00	38	3.00	2023-1.18	■
1.19	8.20	10.00	38	3.00	2023-1.19	■
1.20	8.20	10.00	38	3.00	2023-1.20	■
1.21	8.20	10.00	38	3.00	2023-1.21	■
1.22	8.20	10.00	38	3.00	2023-1.22	■
1.23	8.20	10.00	38	3.00	2023-1.23	■
1.24	8.20	10.00	38	3.00	2023-1.24	■
1.25	8.20	10.00	38	3.00	2023-1.25	■
1.26	8.20	10.00	38	3.00	2023-1.26	■
1.27	8.20	10.00	38	3.00	2023-1.27	■
1.28	8.20	10.00	38	3.00	2023-1.28	■
1.29	8.20	10.00	38	3.00	2023-1.29	■
1.30	8.20	10.00	38	3.00	2023-1.30	■
1.31	9.20	11.20	38	3.00	2023-1.31	■
1.32	9.20	11.20	38	3.00	2023-1.32	■
1.33	9.20	11.20	38	3.00	2023-1.33	■
1.34	9.20	11.20	38	3.00	2023-1.34	■
1.35	9.20	11.20	38	3.00	2023-1.35	■
1.36	9.20	11.20	38	3.00	2023-1.36	■
1.37	9.20	11.20	38	3.00	2023-1.37	■
1.38	9.20	11.20	38	3.00	2023-1.38	■
1.39	9.20	11.20	38	3.00	2023-1.39	■
1.40	9.20	11.20	38	3.00	2023-1.40	■
1.41	9.20	11.20	38	3.00	2023-1.41	■
1.42	9.20	11.20	38	3.00	2023-1.42	■
1.43	9.20	11.20	38	3.00	2023-1.43	■
1.44	9.20	11.20	38	3.00	2023-1.44	■
1.45	9.20	11.20	38	3.00	2023-1.45	■
1.46	9.20	11.20	38	3.00	2023-1.46	■
1.47	9.20	11.20	38	3.00	2023-1.47	■
1.48	9.20	11.20	38	3.00	2023-1.48	■
1.49	9.20	11.20	38	3.00	2023-1.49	■
1.50	9.20	11.20	38	3.00	2023-1.50	■

D1 0/-0.004	L2	L3	L1	D2 h6	Art. N°	Z
1.51	11.20	13.40	38	3.00	2023-1.51	■
1.52	11.20	13.40	38	3.00	2023-1.52	■
1.53	11.20	13.40	38	3.00	2023-1.53	■
1.54	11.20	13.40	38	3.00	2023-1.54	■
1.55	11.20	13.40	38	3.00	2023-1.55	■
1.56	11.20	13.40	38	3.00	2023-1.56	■
1.57	11.20	13.40	38	3.00	2023-1.57	■
1.58	11.20	13.40	38	3.00	2023-1.58	■
1.59	11.20	13.40	38	3.00	2023-1.59	■
1.60	11.20	13.40	38	3.00	2023-1.60	■
1.61	11.20	13.40	38	3.00	2023-1.61	■
1.62	11.20	13.40	38	3.00	2023-1.62	■
1.63	11.20	13.40	38	3.00	2023-1.63	■
1.64	11.20	13.40	38	3.00	2023-1.64	■
1.65	11.20	13.40	38	3.00	2023-1.65	■
1.66	11.20	13.40	38	3.00	2023-1.66	■
1.67	11.20	13.40	38	3.00	2023-1.67	■
1.68	11.20	13.40	38	3.00	2023-1.68	■
1.69	11.20	13.40	38	3.00	2023-1.69	■
1.70	11.20	13.40	38	3.00	2023-1.70	■
1.71	11.20	13.40	38	3.00	2023-1.71	■
1.72	11.20	13.40	38	3.00	2023-1.72	■
1.73	11.20	13.40	38	3.00	2023-1.73	■
1.74	11.20	13.40	38	3.00	2023-1.74	■
1.75	11.20	13.40	38	3.00	2023-1.75	■
1.76	11.20	13.40	38	3.00	2023-1.76	■
1.77	11.20	13.40	38	3.00	2023-1.77	■
1.78	11.20	13.40	38	3.00	2023-1.78	■
1.79	11.20	13.40	38	3.00	2023-1.79	■
1.80	11.20	13.40	38	3.00	2023-1.80	■
1.81	11.20	13.40	38	3.00	2023-1.81	■
1.82	11.20	13.40	38	3.00	2023-1.82	■
1.83	11.20	13.40	38	3.00	2023-1.83	■
1.84	11.20	13.40	38	3.00	2023-1.84	■
1.85	11.20	13.40	38	3.00	2023-1.85	■
1.86	11.20	13.40	38	3.00	2023-1.86	■
1.87	11.20	13.40	38	3.00	2023-1.87	■
1.88	11.20	13.40	38	3.00	2023-1.88	■
1.89	11.20	13.40	38	3.00	2023-1.89	■
1.90	11.20	13.40	38	3.00	2023-1.90	■
1.91	11.20	13.40	38	3.00	2023-1.91	■
1.92	11.20	13.40	38	3.00	2023-1.92	■
1.93	11.20	13.40	38	3.00	2023-1.93	■
1.94	11.20	13.40	38	3.00	2023-1.94	■
1.95	11.20	13.40	38	3.00	2023-1.95	■
1.96	11.20	13.40	38	3.00	2023-1.96	■
1.97	11.20	13.40	38	3.00	2023-1.97	■
1.98	11.20	13.40	38	3.00	2023-1.98	■
1.99	11.20	13.40	38	3.00	2023-1.99	■
2.00	11.20	13.40	38	3.00	2023-2.00	■

Micro-forets

Mikrobohrer

Micro drills

Ø 2.01 - Ø 3.00 mm

2023

D1 0/-0.004	L2	L3	L1	D2 h6	Art. N°	Z
2.01	12.50	14.00	38	3.00	2023-2.01	■
2.02	12.50	14.00	38	3.00	2023-2.02	■
2.03	12.50	14.00	38	3.00	2023-2.03	■
2.04	12.50	14.00	38	3.00	2023-2.04	■
2.05	12.50	14.00	38	3.00	2023-2.05	■
2.06	12.50	14.00	38	3.00	2023-2.06	■
2.07	12.50	14.00	38	3.00	2023-2.07	■
2.08	12.50	14.00	38	3.00	2023-2.08	■
2.09	12.50	14.00	38	3.00	2023-2.09	■
2.10	12.50	14.00	38	3.00	2023-2.10	■
2.11	12.50	14.00	38	3.00	2023-2.11	■
2.12	12.50	14.00	38	3.00	2023-2.12	■
2.13	12.50	14.00	38	3.00	2023-2.13	■
2.14	12.50	14.00	38	3.00	2023-2.14	■
2.15	12.50	14.00	38	3.00	2023-2.15	■
2.16	12.50	14.00	38	3.00	2023-2.16	■
2.17	12.50	14.00	38	3.00	2023-2.17	■
2.18	12.50	14.00	38	3.00	2023-2.18	■
2.19	12.50	14.00	38	3.00	2023-2.19	■
2.20	12.50	14.00	38	3.00	2023-2.20	■
2.21	12.50	14.00	38	3.00	2023-2.21	■
2.22	12.50	14.00	38	3.00	2023-2.22	■
2.23	12.50	14.00	38	3.00	2023-2.23	■
2.24	12.50	14.00	38	3.00	2023-2.24	■
2.25	12.50	14.00	38	3.00	2023-2.25	■
2.26	12.50	14.00	38	3.00	2023-2.26	■
2.27	12.50	14.00	38	3.00	2023-2.27	■
2.28	12.50	14.00	38	3.00	2023-2.28	■
2.29	12.50	14.00	38	3.00	2023-2.29	■
2.30	12.50	14.00	38	3.00	2023-2.30	■
2.31	12.50	14.00	38	3.00	2023-2.31	■
2.32	12.50	14.00	38	3.00	2023-2.32	■
2.33	12.50	14.00	38	3.00	2023-2.33	■
2.34	12.50	14.00	38	3.00	2023-2.34	■
2.35	12.50	14.00	38	3.00	2023-2.35	■
2.36	12.50	14.00	38	3.00	2023-2.36	■
2.37	12.50	14.00	38	3.00	2023-2.37	■
2.38	12.50	14.00	38	3.00	2023-2.38	■
2.39	12.50	14.00	38	3.00	2023-2.39	■
2.40	12.50	14.00	38	3.00	2023-2.40	■
2.41	12.50	14.00	38	3.00	2023-2.41	■
2.42	12.50	14.00	38	3.00	2023-2.42	■
2.43	12.50	14.00	38	3.00	2023-2.43	■
2.44	12.50	14.00	38	3.00	2023-2.44	■
2.45	12.50	14.00	38	3.00	2023-2.45	■
2.46	12.50	14.00	38	3.00	2023-2.46	■
2.47	12.50	14.00	38	3.00	2023-2.47	■
2.48	12.50	14.00	38	3.00	2023-2.48	■
2.49	12.50	14.00	38	3.00	2023-2.49	■
2.50	14.00	17.00	38	3.00	2023-2.50	■

D1 0/-0.004	L2	L3	L1	D2 h6	Art. N°	Z
2.51	14.00	17.00	38	3.00	2023-2.51	■
2.52	14.00	17.00	38	3.00	2023-2.52	■
2.53	14.00	17.00	38	3.00	2023-2.53	■
2.54	14.00	17.00	38	3.00	2023-2.54	■
2.55	14.00	17.00	38	3.00	2023-2.55	■
2.56	14.00	17.00	38	3.00	2023-2.56	■
2.57	14.00	17.00	38	3.00	2023-2.57	■
2.58	14.00	17.00	38	3.00	2023-2.58	■
2.59	14.00	17.00	38	3.00	2023-2.59	■
2.60	14.00	17.00	38	3.00	2023-2.60	■
2.61	14.00	17.00	38	3.00	2023-2.61	■
2.62	14.00	17.00	38	3.00	2023-2.62	■
2.63	14.00	17.00	38	3.00	2023-2.63	■
2.64	14.00	17.00	38	3.00	2023-2.64	■
2.65	14.00	17.00	38	3.00	2023-2.65	■
2.66	14.00	17.00	38	3.00	2023-2.66	■
2.67	14.00	17.00	38	3.00	2023-2.67	■
2.68	14.00	17.00	38	3.00	2023-2.68	■
2.69	14.00	17.00	38	3.00	2023-2.69	■
2.70	14.00	17.00	38	3.00	2023-2.70	■
2.71	14.00	17.00	38	3.00	2023-2.71	■
2.72	14.00	17.00	38	3.00	2023-2.72	■
2.73	14.00	17.00	38	3.00	2023-2.73	■
2.74	14.00	17.00	38	3.00	2023-2.74	■
2.75	14.00	17.00	38	3.00	2023-2.75	■
2.76	14.00	17.00	38	3.00	2023-2.76	■
2.77	14.00	17.00	38	3.00	2023-2.77	■
2.78	14.00	17.00	38	3.00	2023-2.78	■
2.79	14.00	17.00	38	3.00	2023-2.79	■
2.80	14.00	17.00	38	3.00	2023-2.80	■
2.81	14.00	17.00	38	3.00	2023-2.81	■
2.82	14.00	17.00	38	3.00	2023-2.82	■
2.83	14.00	17.00	38	3.00	2023-2.83	■
2.84	14.00	17.00	38	3.00	2023-2.84	■
2.85	14.00	17.00	38	3.00	2023-2.85	■
2.86	14.00	17.00	38	3.00	2023-2.86	■
2.87	14.00	17.00	38	3.00	2023-2.87	■
2.88	14.00	17.00	38	3.00	2023-2.88	■
2.89	14.00	17.00	38	3.00	2023-2.89	■
2.90	14.00	17.00	38	3.00	2023-2.90	■
2.91	14.00	17.00	38	3.00	2023-2.91	■
2.92	14.00	17.00	38	3.00	2023-2.92	■
2.93	14.00	17.00	38	3.00	2023-2.93	■
2.94	14.00	17.00	38	3.00	2023-2.94	■
2.95	14.00	17.00	38	3.00	2023-2.95	■
2.96	14.00	17.00	38	3.00	2023-2.96	■
2.97	14.00	17.00	38	3.00	2023-2.97	■
2.98	14.00	17.00	38	3.00	2023-2.98	■
2.99	14.00	17.00	38	3.00	2023-2.99	■
3.00	14.00	17.00	38	3.00	2023-3.00	■

MICRO-LINE

Micro-forets

Mikrobohrer

Micro drills

Ø 0.20 - Ø 1.09 mm

2026

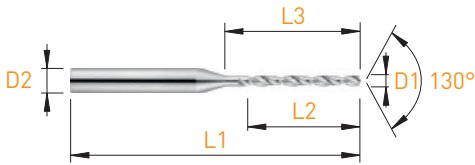

MD VHM HM	λ^{25°	Z=2	12xD1	130°	
-----------------	----------------------	-----	-------	------	--

D1 h6	L2	L3	L1	D2 h6	Art. N°	Z
0.20	2.40	3.50	38	3.00	2026-0.20	■
0.21	2.50	3.50	38	3.00	2026-0.21	■
0.22	2.70	3.50	38	3.00	2026-0.22	■
0.23	2.80	3.50	38	3.00	2026-0.23	■
0.24	2.90	4.00	38	3.00	2026-0.24	■
0.25	3.00	4.00	38	3.00	2026-0.25	■
0.26	3.10	4.00	38	3.00	2026-0.26	■
0.27	3.30	4.00	38	3.00	2026-0.27	■
0.28	3.40	4.50	38	3.00	2026-0.28	■
0.29	3.50	4.50	38	3.00	2026-0.29	■
0.30	3.60	4.50	38	3.00	2026-0.30	■
0.31	3.70	4.50	38	3.00	2026-0.31	■
0.32	3.90	5.00	38	3.00	2026-0.32	■
0.33	4.00	5.00	38	3.00	2026-0.33	■
0.34	4.10	5.00	38	3.00	2026-0.34	■
0.35	4.20	5.00	38	3.00	2026-0.35	■
0.36	4.30	5.50	38	3.00	2026-0.36	■
0.37	4.50	5.50	38	3.00	2026-0.37	■
0.38	4.60	5.50	38	3.00	2026-0.38	■
0.39	4.70	5.50	38	3.00	2026-0.39	■
0.40	4.80	6.00	38	3.00	2026-0.40	■
0.41	4.90	6.00	38	3.00	2026-0.41	■
0.42	5.10	6.00	38	3.00	2026-0.42	■
0.43	5.20	6.00	38	3.00	2026-0.43	■
0.44	5.30	6.50	38	3.00	2026-0.44	■
0.45	5.40	6.50	38	3.00	2026-0.45	■
0.46	5.50	6.50	38	3.00	2026-0.46	■
0.47	5.70	6.50	38	3.00	2026-0.47	■
0.48	5.80	7.00	38	3.00	2026-0.48	■
0.49	5.90	7.00	38	3.00	2026-0.49	■
0.50	6.00	7.00	38	3.00	2026-0.50	■
0.51	6.10	7.00	38	3.00	2026-0.51	■
0.52	6.30	7.50	38	3.00	2026-0.52	■
0.53	6.40	7.50	38	3.00	2026-0.53	■
0.54	6.50	7.50	38	3.00	2026-0.54	■
0.55	6.60	7.50	38	3.00	2026-0.55	■
0.56	6.70	8.00	38	3.00	2026-0.56	■
0.57	6.90	8.00	38	3.00	2026-0.57	■
0.58	7.00	8.00	38	3.00	2026-0.58	■

D1 h6	L2	L3	L1	D2 h6	Art. N°	Z
0.59	7.10	8.00	38	3.00	2026-0.59	■
0.60	7.20	9.00	38	3.00	2026-0.60	■
0.61	7.30	9.00	38	3.00	2026-0.61	■
0.62	7.50	9.00	38	3.00	2026-0.62	■
0.63	7.60	9.00	38	3.00	2026-0.63	■
0.64	7.70	9.50	38	3.00	2026-0.64	■
0.65	7.80	9.50	38	3.00	2026-0.65	■
0.66	7.90	9.50	38	3.00	2026-0.66	■
0.67	8.10	9.50	38	3.00	2026-0.67	■
0.68	8.20	10.00	38	3.00	2026-0.68	■
0.69	8.30	10.00	38	3.00	2026-0.69	■
0.70	8.40	10.00	38	3.00	2026-0.70	■
0.71	8.50	10.00	38	3.00	2026-0.71	■
0.72	8.70	10.50	38	3.00	2026-0.72	■
0.73	8.80	10.50	38	3.00	2026-0.73	■
0.74	8.90	10.50	38	3.00	2026-0.74	■
0.75	9.00	10.50	38	3.00	2026-0.75	■
0.76	9.10	11.00	38	3.00	2026-0.76	■
0.77	9.30	11.00	38	3.00	2026-0.77	■
0.78	9.40	11.00	38	3.00	2026-0.78	■
0.79	9.50	11.00	38	3.00	2026-0.79	■
0.80	9.60	11.50	38	3.00	2026-0.80	■
0.81	9.70	11.50	38	3.00	2026-0.81	■
0.82	9.90	11.50	38	3.00	2026-0.82	■
0.83	10.00	11.50	38	3.00	2026-0.83	■
0.84	10.10	12.00	38	3.00	2026-0.84	■
0.85	10.20	12.00	38	3.00	2026-0.85	■
0.86	10.30	12.00	38	3.00	2026-0.86	■
0.87	10.50	12.00	38	3.00	2026-0.87	■
0.88	10.60	12.50	38	3.00	2026-0.88	■
0.89	10.70	12.50	38	3.00	2026-0.89	■
0.90	10.80	12.50	38	3.00	2026-0.90	■
0.91	10.90	12.50	38	3.00	2026-0.91	■
0.92	11.10	13.00	38	3.00	2026-0.92	■
0.93	11.20	13.00	38	3.00	2026-0.93	■
0.94	11.30	13.00	38	3.00	2026-0.94	■
0.95	11.40	13.00	38	3.00	2026-0.95	■
0.96	11.50	13.50	38	3.00	2026-0.96	■
0.97	11.70	13.50	38	3.00	2026-0.97	■
0.98	11.80	13.50	38	3.00	2026-0.98	■
0.99	11.90	13.50	38	3.00	2026-0.99	■
1.00	12.00	14.50	38	3.00	2026-1.00	■
1.01	12.10	14.50	38	3.00	2026-1.01	■
1.02	12.30	14.50	38	3.00	2026-1.02	■
1.03	12.40	14.50	38	3.00	2026-1.03	■
1.04	12.50	15.00	38	3.00	2026-1.04	■
1.05	12.60	15.00	38	3.00	2026-1.05	■
1.06	12.70	15.00	38	3.00	2026-1.06	■
1.07	12.90	15.00	38	3.00	2026-1.07	■
1.08	13.00	15.50	38	3.00	2026-1.08	■
1.09	13.10	15.50	38	3.00	2026-1.09	■

Micro-forets

Mikrobohrer

Micro drills

Ø 1.10 - Ø 2.00 mm

2026

D1 h6	L2	L3	L1	D2 h6	Art. N°	Z
1.10	13.20	15.50	38	3.00	2026-1.10	■
1.11	13.30	15.50	38	3.00	2026-1.11	■
1.12	13.50	16.00	38	3.00	2026-1.12	■
1.13	13.60	16.00	38	3.00	2026-1.13	■
1.14	13.70	16.00	38	3.00	2026-1.14	■
1.15	13.80	16.00	38	3.00	2026-1.15	■
1.16	13.90	16.50	38	3.00	2026-1.16	■
1.17	14.10	16.50	38	3.00	2026-1.17	■
1.18	14.20	16.50	38	3.00	2026-1.18	■
1.19	14.30	16.50	38	3.00	2026-1.19	■
1.20	14.40	17.00	38	3.00	2026-1.20	■
1.21	14.50	17.00	38	3.00	2026-1.21	■
1.22	14.70	17.00	38	3.00	2026-1.22	■
1.23	14.80	17.00	38	3.00	2026-1.23	■
1.24	14.90	17.50	38	3.00	2026-1.24	■
1.25	15.00	17.50	38	3.00	2026-1.25	■
1.26	15.10	17.50	50	3.00	2026-1.26	■
1.27	15.30	17.50	50	3.00	2026-1.27	■
1.28	15.40	18.00	50	3.00	2026-1.28	■
1.29	15.50	18.00	50	3.00	2026-1.29	■
1.30	15.60	18.00	50	3.00	2026-1.30	■
1.31	15.70	18.00	50	3.00	2026-1.31	■
1.32	15.90	18.50	50	3.00	2026-1.32	■
1.33	16.00	18.50	50	3.00	2026-1.33	■
1.34	16.10	18.50	50	3.00	2026-1.34	■
1.35	16.20	18.50	50	3.00	2026-1.35	■
1.36	16.30	19.00	50	3.00	2026-1.36	■
1.37	16.50	19.00	50	3.00	2026-1.37	■
1.38	16.60	19.00	50	3.00	2026-1.38	■
1.39	16.70	19.00	50	3.00	2026-1.39	■
1.40	16.80	19.50	50	3.00	2026-1.40	■
1.41	16.90	19.50	50	3.00	2026-1.41	■
1.42	17.10	19.50	50	3.00	2026-1.42	■
1.43	17.20	19.50	50	3.00	2026-1.43	■
1.44	17.30	20.00	50	3.00	2026-1.44	■
1.45	17.40	20.00	50	3.00	2026-1.45	■
1.46	17.50	20.00	50	3.00	2026-1.46	■
1.47	17.70	20.00	50	3.00	2026-1.47	■
1.48	17.80	20.50	50	3.00	2026-1.48	■
1.49	17.90	20.50	50	3.00	2026-1.49	■
1.50	18.00	21.00	50	3.00	2026-1.50	■
1.51	18.10	21.00	50	3.00	2026-1.51	■
1.52	18.30	21.00	50	3.00	2026-1.52	■
1.53	18.40	21.00	50	3.00	2026-1.53	■
1.54	18.50	21.50	50	3.00	2026-1.54	■
1.55	18.60	21.50	50	3.00	2026-1.55	■
1.56	18.70	21.50	50	3.00	2026-1.56	■
1.57	18.90	21.50	50	3.00	2026-1.57	■
1.58	19.00	22.00	50	3.00	2026-1.58	■
1.59	19.10	22.00	50	3.00	2026-1.59	■
1.60	19.20	22.00	50	3.00	2026-1.60	■

D1 h6	L2	L3	L1	D2 h6	Art. N°	Z
1.61	19.30	22.00	50	3.00	2026-1.61	■
1.62	19.40	22.50	50	3.00	2026-1.62	■
1.63	19.60	22.50	50	3.00	2026-1.63	■
1.64	19.70	22.50	50	3.00	2026-1.64	■
1.65	19.80	22.50	50	3.00	2026-1.65	■
1.66	19.90	23.00	50	3.00	2026-1.66	■
1.67	20.10	23.00	50	3.00	2026-1.67	■
1.68	20.20	23.00	50	3.00	2026-1.68	■
1.69	20.30	23.00	50	3.00	2026-1.69	■
1.70	20.40	23.50	50	3.00	2026-1.70	■
1.71	20.50	23.50	50	3.00	2026-1.71	■
1.72	20.70	23.50	50	3.00	2026-1.72	■
1.73	20.80	23.50	50	3.00	2026-1.73	■
1.74	20.90	24.00	50	3.00	2026-1.74	■
1.75	21.00	24.00	50	3.00	2026-1.75	■
1.76	21.10	24.00	50	3.00	2026-1.76	■
1.77	21.30	24.00	50	3.00	2026-1.77	■
1.78	21.40	24.50	50	3.00	2026-1.78	■
1.79	21.50	24.50	50	3.00	2026-1.79	■
1.80	21.60	25.00	50	3.00	2026-1.80	■
1.81	21.70	25.00	50	3.00	2026-1.81	■
1.82	21.90	25.00	50	3.00	2026-1.82	■
1.83	22.00	25.00	50	3.00	2026-1.83	■
1.84	22.10	25.50	50	3.00	2026-1.84	■
1.85	22.20	25.50	50	3.00	2026-1.85	■
1.86	22.30	25.50	50	3.00	2026-1.86	■
1.87	22.50	25.50	50	3.00	2026-1.87	■
1.88	22.60	26.00	50	3.00	2026-1.88	■
1.89	22.70	26.00	50	3.00	2026-1.89	■
1.90	22.80	26.00	50	3.00	2026-1.90	■
1.91	22.90	26.00	50	3.00	2026-1.91	■
1.92	23.10	26.50	50	3.00	2026-1.92	■
1.93	23.20	26.50	50	3.00	2026-1.93	■
1.94	23.30	26.50	50	3.00	2026-1.94	■
1.95	23.40	26.50	50	3.00	2026-1.95	■
1.96	23.50	27.00	50	3.00	2026-1.96	■
1.97	23.70	27.00	50	3.00	2026-1.97	■
1.98	23.80	27.00	50	3.00	2026-1.98	■
1.99	23.90	27.00	50	3.00	2026-1.99	■
2.00	24.00	27.00	50	3.00	2026-2.00	■

MICRO-LINE

Micro-forets

Mikrobohrer

Micro drills

Ø 0.20 - Ø 1.09 mm

2030

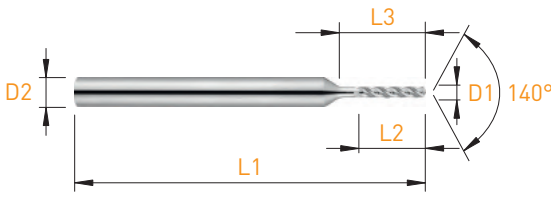

D1 h6	L2	L3	L1	D2 h6	Art. N°	z
0.20	1.00	1.50	38	3.00	2030-0.20	■
0.21	1.05	1.50	38	3.00	2030-0.21	■
0.22	1.10	1.60	38	3.00	2030-0.22	■
0.23	1.15	1.60	38	3.00	2030-0.23	■
0.24	1.20	1.70	38	3.00	2030-0.24	■
0.25	1.25	1.70	38	3.00	2030-0.25	■
0.26	1.30	1.80	38	3.00	2030-0.26	■
0.27	1.35	1.80	38	3.00	2030-0.27	■
0.28	1.40	1.90	38	3.00	2030-0.28	■
0.29	1.45	1.90	38	3.00	2030-0.29	■
0.30	1.50	2.00	38	3.00	2030-0.30	■
0.31	1.55	2.00	38	3.00	2030-0.31	■
0.32	1.60	2.10	38	3.00	2030-0.32	■
0.33	1.65	2.10	38	3.00	2030-0.33	■
0.34	1.70	2.20	38	3.00	2030-0.34	■
0.35	1.75	2.20	38	3.00	2030-0.35	■
0.36	1.80	2.30	38	3.00	2030-0.36	■
0.37	1.85	2.30	38	3.00	2030-0.37	■
0.38	1.90	2.40	38	3.00	2030-0.38	■
0.39	1.95	2.40	38	3.00	2030-0.39	■
0.40	2.00	2.50	38	3.00	2030-0.40	■
0.41	2.05	2.50	38	3.00	2030-0.41	■
0.42	2.10	2.60	38	3.00	2030-0.42	■
0.43	2.15	2.60	38	3.00	2030-0.43	■
0.44	2.20	2.70	38	3.00	2030-0.44	■
0.45	2.25	2.70	38	3.00	2030-0.45	■
0.46	2.30	2.80	38	3.00	2030-0.46	■
0.47	2.35	2.80	38	3.00	2030-0.47	■
0.48	2.40	2.90	38	3.00	2030-0.48	■
0.49	2.45	2.90	38	3.00	2030-0.49	■
0.50	2.50	3.00	38	3.00	2030-0.50	■
0.51	2.55	3.00	38	3.00	2030-0.51	■
0.52	2.60	3.10	38	3.00	2030-0.52	■
0.53	2.65	3.10	38	3.00	2030-0.53	■
0.54	2.70	3.20	38	3.00	2030-0.54	■
0.55	2.75	3.20	38	3.00	2030-0.55	■
0.56	2.80	3.30	38	3.00	2030-0.56	■
0.57	2.85	3.30	38	3.00	2030-0.57	■
0.58	2.90	3.40	38	3.00	2030-0.58	■

D1 h6	L2	L3	L1	D2 h6	Art. N°	z
0.59	2.95	3.40	38	3.00	2030-0.59	■
0.60	3.00	3.50	38	3.00	2030-0.60	■
0.61	3.05	3.50	38	3.00	2030-0.61	■
0.62	3.10	3.60	38	3.00	2030-0.62	■
0.63	3.15	3.60	38	3.00	2030-0.63	■
0.64	3.20	3.70	38	3.00	2030-0.64	■
0.65	3.25	3.70	38	3.00	2030-0.65	■
0.66	3.30	3.80	38	3.00	2030-0.66	■
0.67	3.35	3.80	38	3.00	2030-0.67	■
0.68	3.40	3.90	38	3.00	2030-0.68	■
0.69	3.45	3.90	38	3.00	2030-0.69	■
0.70	3.50	4.00	38	3.00	2030-0.70	■
0.71	3.55	4.00	38	3.00	2030-0.71	■
0.72	3.60	4.10	38	3.00	2030-0.72	■
0.73	3.65	4.10	38	3.00	2030-0.73	■
0.74	3.70	4.20	38	3.00	2030-0.74	■
0.75	3.75	4.20	38	3.00	2030-0.75	■
0.76	3.80	4.30	38	3.00	2030-0.76	■
0.77	3.85	4.30	38	3.00	2030-0.77	■
0.78	3.90	4.40	38	3.00	2030-0.78	■
0.79	3.95	4.40	38	3.00	2030-0.79	■
0.80	4.00	4.50	38	3.00	2030-0.80	■
0.81	4.05	4.50	38	3.00	2030-0.81	■
0.82	4.10	4.60	38	3.00	2030-0.82	■
0.83	4.15	4.60	38	3.00	2030-0.83	■
0.84	4.20	4.70	38	3.00	2030-0.84	■
0.85	4.25	4.70	38	3.00	2030-0.85	■
0.86	4.30	4.80	38	3.00	2030-0.86	■
0.87	4.35	4.80	38	3.00	2030-0.87	■
0.88	4.40	4.90	38	3.00	2030-0.88	■
0.89	4.45	4.90	38	3.00	2030-0.89	■
0.90	4.50	5.00	38	3.00	2030-0.90	■
0.91	4.55	5.00	38	3.00	2030-0.91	■
0.92	4.60	5.10	38	3.00	2030-0.92	■
0.93	4.65	5.10	38	3.00	2030-0.93	■
0.94	4.70	5.20	38	3.00	2030-0.94	■
0.95	4.75	5.20	38	3.00	2030-0.95	■
0.96	4.80	5.30	38	3.00	2030-0.96	■
0.97	4.85	5.30	38	3.00	2030-0.97	■
0.98	4.90	5.40	38	3.00	2030-0.98	■
0.99	4.95	5.40	38	3.00	2030-0.99	■
1.00	5.00	6.50	38	3.00	2030-1.00	■
1.01	5.05	6.50	38	3.00	2030-1.01	■
1.02	5.10	6.50	38	3.00	2030-1.02	■
1.03	5.15	6.50	38	3.00	2030-1.03	■
1.04	5.20	6.50	38	3.00	2030-1.04	■
1.05	5.25	6.50	38	3.00	2030-1.05	■
1.06	5.30	6.50	38	3.00	2030-1.06	■
1.07	5.35	7.50	38	3.00	2030-1.07	■
1.08	5.40	7.50	38	3.00	2030-1.08	■
1.09	5.45	7.50	38	3.00	2030-1.09	■

Micro-forets

Mikrobohrer

Micro drills

Ø 1.10 - Ø 2.11 mm

2030

D1 h6	L2	L3	L1	D2 h6	Art. N°	z
1.10	5.50	7.50	38	3.00	2030-1.10	■
1.11	5.55	7.50	38	3.00	2030-1.11	■
1.12	5.60	7.50	38	3.00	2030-1.12	■
1.13	5.65	7.50	38	3.00	2030-1.13	■
1.14	5.70	7.50	38	3.00	2030-1.14	■
1.15	5.75	7.50	38	3.00	2030-1.15	■
1.16	5.80	7.50	38	3.00	2030-1.16	■
1.17	5.85	7.50	38	3.00	2030-1.17	■
1.18	5.90	8.50	38	3.00	2030-1.18	■
1.19	5.95	8.50	38	3.00	2030-1.19	■
1.20	6.00	8.50	38	3.00	2030-1.20	■
1.21	6.05	8.50	38	3.00	2030-1.21	■
1.22	6.10	8.50	38	3.00	2030-1.22	■
1.23	6.15	8.50	38	3.00	2030-1.23	■
1.24	6.20	8.50	38	3.00	2030-1.24	■
1.25	6.25	8.50	38	3.00	2030-1.25	■
1.26	6.30	8.50	38	3.00	2030-1.26	■
1.27	6.35	8.50	38	3.00	2030-1.27	■
1.28	6.40	8.50	38	3.00	2030-1.28	■
1.29	6.45	8.50	38	3.00	2030-1.29	■
1.30	6.50	8.50	38	3.00	2030-1.30	■
1.31	6.55	8.50	38	3.00	2030-1.31	■
1.32	6.60	8.50	38	3.00	2030-1.32	■
1.33	6.65	9.50	38	3.00	2030-1.33	■
1.34	6.70	9.50	38	3.00	2030-1.34	■
1.35	6.75	9.50	38	3.00	2030-1.35	■
1.36	6.80	9.50	38	3.00	2030-1.36	■
1.37	6.85	9.50	38	3.00	2030-1.37	■
1.38	6.90	9.50	38	3.00	2030-1.38	■
1.39	6.95	9.50	38	3.00	2030-1.39	■
1.40	7.00	9.50	38	3.00	2030-1.40	■
1.41	7.05	9.50	38	3.00	2030-1.41	■
1.42	7.10	9.50	38	3.00	2030-1.42	■
1.43	7.15	9.50	38	3.00	2030-1.43	■
1.44	7.20	9.50	38	3.00	2030-1.44	■
1.45	7.25	9.50	38	3.00	2030-1.45	■
1.46	7.30	9.50	38	3.00	2030-1.46	■
1.47	7.35	9.50	38	3.00	2030-1.47	■
1.48	7.40	9.50	38	3.00	2030-1.48	■
1.49	7.45	9.50	38	3.00	2030-1.49	■
1.50	7.50	9.50	38	3.00	2030-1.50	■
1.51	7.55	10.50	38	3.00	2030-1.51	■
1.52	7.60	10.50	38	3.00	2030-1.52	■
1.53	7.65	10.50	38	3.00	2030-1.53	■
1.54	7.70	10.50	38	3.00	2030-1.54	■
1.55	7.75	10.50	38	3.00	2030-1.55	■
1.56	7.80	10.50	38	3.00	2030-1.56	■
1.57	7.85	10.50	38	3.00	2030-1.57	■
1.58	7.90	10.50	38	3.00	2030-1.58	■
1.59	7.95	10.50	38	3.00	2030-1.59	■
1.60	8.00	10.50	38	3.00	2030-1.60	■

D1 h6	L2	L3	L1	D2 h6	Art. N°	z
1.61	8.05	10.50	38	3.00	2030-1.61	■
1.62	8.10	10.50	38	3.00	2030-1.62	■
1.63	8.15	10.50	38	3.00	2030-1.63	■
1.64	8.20	10.50	38	3.00	2030-1.64	■
1.65	8.25	10.50	38	3.00	2030-1.65	■
1.66	8.30	10.50	38	3.00	2030-1.66	■
1.67	8.35	10.50	38	3.00	2030-1.67	■
1.68	8.40	10.50	38	3.00	2030-1.68	■
1.69	8.45	10.50	38	3.00	2030-1.69	■
1.70	8.50	10.50	38	3.00	2030-1.70	■
1.71	8.55	11.50	38	3.00	2030-1.71	■
1.72	8.60	11.50	38	3.00	2030-1.72	■
1.73	8.65	11.50	38	3.00	2030-1.73	■
1.74	8.70	11.50	38	3.00	2030-1.74	■
1.75	8.75	11.50	38	3.00	2030-1.75	■
1.76	8.80	11.50	38	3.00	2030-1.76	■
1.77	8.85	11.50	38	3.00	2030-1.77	■
1.78	8.90	11.50	38	3.00	2030-1.78	■
1.79	8.95	11.50	38	3.00	2030-1.79	■
1.80	9.00	11.50	38	3.00	2030-1.80	■
1.81	9.05	11.50	38	3.00	2030-1.81	■
1.82	9.10	11.50	38	3.00	2030-1.82	■
1.83	9.15	11.50	38	3.00	2030-1.83	■
1.84	9.20	11.50	38	3.00	2030-1.84	■
1.85	9.25	11.50	38	3.00	2030-1.85	■
1.86	9.30	11.50	38	3.00	2030-1.86	■
1.87	9.35	11.50	38	3.00	2030-1.87	■
1.88	9.40	11.50	38	3.00	2030-1.88	■
1.89	9.45	11.50	38	3.00	2030-1.89	■
1.90	9.50	11.50	38	3.00	2030-1.90	■
1.91	9.55	12.50	38	3.00	2030-1.91	■
1.92	9.60	12.50	38	3.00	2030-1.92	■
1.93	9.65	12.50	38	3.00	2030-1.93	■
1.94	9.70	12.50	38	3.00	2030-1.94	■
1.95	9.75	12.50	38	3.00	2030-1.95	■
1.96	9.80	12.50	38	3.00	2030-1.96	■
1.97	9.85	12.50	38	3.00	2030-1.97	■
1.98	9.90	12.50	38	3.00	2030-1.98	■
1.99	9.95	12.50	38	3.00	2030-1.99	■
2.00	10.00	12.50	38	3.00	2030-2.00	■
2.01	10.05	12.50	38	3.00	2030-2.01	■
2.02	10.10	12.50	38	3.00	2030-2.02	■
2.03	10.15	12.50	38	3.00	2030-2.03	■
2.04	10.20	12.50	38	3.00	2030-2.04	■
2.05	10.25	12.50	38	3.00	2030-2.05	■
2.06	10.30	12.50	38	3.00	2030-2.06	■
2.07	10.35	12.50	38	3.00	2030-2.07	■
2.08	10.40	12.50	38	3.00	2030-2.08	■
2.09	10.45	12.50	38	3.00	2030-2.09	■
2.10	10.50	12.50	38	3.00	2030-2.10	■
2.11	10.55	12.50	38	3.00	2030-2.11	■

D1 h6	L2	L3	L1	D2 h6	Art. N°	z
2.12	10.60	12.50	38	3.00	2030-2.12	■
2.13	10.65	13.50	38	3.00	2030-2.13	■
2.14	10.70	13.50	38	3.00	2030-2.14	■
2.15	10.75	13.50	38	3.00	2030-2.15	■
2.16	10.80	13.50	38	3.00	2030-2.16	■
2.17	10.85	13.50	38	3.00	2030-2.17	■
2.18	10.90	13.50	38	3.00	2030-2.18	■
2.19	10.95	13.50	38	3.00	2030-2.19	■
2.20	11.00	13.50	38	3.00	2030-2.20	■
2.21	11.05	13.50	38	3.00	2030-2.21	■
2.22	11.10	13.50	38	3.00	2030-2.22	■
2.23	11.15	13.50	38	3.00	2030-2.23	■
2.24	11.20	13.50	38	3.00	2030-2.24	■
2.25	11.25	13.50	38	3.00	2030-2.25	■
2.26	11.30	13.50	38	3.00	2030-2.26	■
2.27	11.35	13.50	38	3.00	2030-2.27	■
2.28	11.40	13.50	38	3.00	2030-2.28	■
2.29	11.45	13.50	38	3.00	2030-2.29	■
2.30	11.50	13.50	38	3.00	2030-2.30	■
2.31	11.55	13.50	38	3.00	2030-2.31	■
2.32	11.60	13.50	38	3.00	2030-2.32	■
2.33	11.65	13.50	38	3.00	2030-2.33	■
2.34	11.70	13.50	38	3.00	2030-2.34	■
2.35	11.75	13.50	38	3.00	2030-2.35	■
2.36	11.80	13.50	38	3.00	2030-2.36	■
2.37	11.85	14.50	38	3.00	2030-2.37	■
2.38	11.90	14.50	38	3.00	2030-2.38	■
2.39	11.95	14.50	38	3.00	2030-2.39	■
2.40	12.00	14.50	38	3.00	2030-2.40	■
2.41	12.05	14.50	38	3.00	2030-2.41	■
2.42	12.10	14.50	38	3.00	2030-2.42	■
2.43	12.15	14.50	38	3.00	2030-2.43	■
2.44	12.20	14.50	38	3.00	2030-2.44	■
2.45	12.25	14.50	38	3.00	2030-2.45	■
2.46	12.30	14.50	38	3.00	2030-2.46	■
2.47	12.35	14.50	38	3.00	2030-2.47	■
2.48	12.40	14.50	38	3.00	2030-2.48	■
2.49	12.45	14.50	38	3.00	2030-2.49	■
2.50	12.50	14.50	38	3.00	2030-2.50	■
2.51	12.55	14.50	38	3.00	2030-2.51	■
2.52	12.60	14.50	38	3.00	2030-2.52	■
2.53	12.65	14.50	38	3.00	2030-2.53	■
2.54	12.70	14.50	38	3.00	2030-2.54	■
2.55	12.75	14.50	38	3.00	2030-2.55	■
2.56	12.80	14.50	38	3.00	2030-2.56	■
2.57	12.85	14.50	38	3.00	2030-2.57	■
2.58	12.90	14.50	38	3.00	2030-2.58	■
2.59	12.95	14.50	38	3.00	2030-2.59	■
2.60	13.00	14.50	38	3.00	2030-2.60	■
2.61	13.05	14.50	38	3.00	2030-2.61	■
2.62	13.10	14.50	38	3.00	2030-2.62	■

D1 h6	L2	L3	L1	D2 h6	Art. N°	z
2.63	13.15	14.50	38	3.00	2030-2.63	■
2.64	13.20	14.50	38	3.00	2030-2.64	■
2.65	13.25	14.50	38	3.00	2030-2.65	■
2.66	13.30	16.50	38	3.00	2030-2.66	■
2.67	13.35	16.50	38	3.00	2030-2.67	■
2.68	13.40	16.50	38	3.00	2030-2.68	■
2.69	13.45	16.50	38	3.00	2030-2.69	■
2.70	13.50	16.50	38	3.00	2030-2.70	■
2.71	13.55	16.55	38	3.00	2030-2.71	■
2.72	13.60	16.50	38	3.00	2030-2.72	■
2.73	13.65	16.50	38	3.00	2030-2.73	■
2.74	13.70	16.50	38	3.00	2030-2.74	■
2.75	13.75	16.50	38	3.00	2030-2.75	■
2.76	13.80	16.50	38	3.00	2030-2.76	■
2.77	13.85	16.50	38	3.00	2030-2.77	■
2.78	13.90	16.50	38	3.00	2030-2.78	■
2.79	13.95	16.50	38	3.00	2030-2.79	■
2.80	14.00	16.50	38	3.00	2030-2.80	■
2.81	14.05	16.50	38	3.00	2030-2.81	■
2.82	14.10	16.50	38	3.00	2030-2.82	■
2.83	14.15	16.50	38	3.00	2030-2.83	■
2.84	14.20	16.50	38	3.00	2030-2.84	■
2.85	14.25	16.50	38	3.00	2030-2.85	■
2.86	14.30	16.50	38	3.00	2030-2.86	■
2.87	14.35	16.50	38	3.00	2030-2.87	■
2.88	14.40	16.50	38	3.00	2030-2.88	■
2.89	14.45	16.50	38	3.00	2030-2.89	■
2.90	14.50	16.50	38	3.00	2030-2.90	■
2.91	14.55	16.50	38	3.00	2030-2.91	■
2.92	14.60	16.50	38	3.00	2030-2.92	■
2.93	14.65	16.50	38	3.00	2030-2.93	■
2.94	14.70	16.50	38	3.00	2030-2.94	■
2.95	14.75	16.50	38	3.00	2030-2.95	■
2.96	14.80	16.50	38	3.00	2030-2.96	■
2.97	14.85	16.50	38	3.00	2030-2.97	■
2.98	14.90	16.50	38	3.00	2030-2.98	■
2.99	14.95	16.50	38	3.00	2030-2.99	■



MICRO-LINE



Informations techniques et symboles

Technische Informationen und Symbole

Technical information and symbols

60° Angle
90° Winkel
120° Angle

 Coins vifs
Scharfkantige Ecken
Sharp corners

λ 25° Angle d'hélice
Spiralwinkel
Helix angle

 Fraises hémisphériques
Radiusfräser
End mills with ball nose

λ 36° Hélice différente
 λ 38° Verschiedene Spirale
 λ 40° Different propeller

 Rayon de coin
Eckradius
Corner radius

λ Hélice progressive
Progressive Spirale
35°/38° Progressiv propeller

 Dents avec coupe centrale
Zähne Zentrumschnitt
Teeth center cutting

Z Nombre de dents
Anzahl der Zähne
Number of teeth

 Denture décalée
Versetzte Verzahnung
Alternated teeth

2xD1 Rapport longueur-diamètre
Länge-Durchmesser Verhältnis
Length to diameter ratio

DHD Denture décalée hélice différente
Versetzte Verzahnung unterschiedliche Spirale
Alternated teeth different helix

 Lèvres, affûtage à facettes
Schneiden, Facettenschärfen
Flutes, sharpening with facets

DHP Denture décalée hélice progressive
Versetzte Verzahnung progressive Spirale
Alternated teeth progressive helix

 Taillage demi-lune
Kanonenbohrer Spitze
Gundrills tip

 Taillage renforcé 3/4
3/4 genuteter Fräser
3/4 straight fluted

 Usinage radial, diagonal et axial
Radiale, diagonale und axiale Bearbeitung
Radial, diagonal and axial machining

 Usinage radial et axial
Radiale und axiale Bearbeitung
Radial and axial machining

Informations techniques et symboles

Technische Informationen und Symbole

Technical information and symbols

Diamètre outil Werkzeugdurchmesser Tool diameter	D (mm)		
Nombre de dents Zähnezahl Number of teeth	Z		
Profondeur de coupe Schnitttiefe Cutting depth	ap (mm)		
Largeur de coupe Schnittbreite Cutting width	ae (mm)		
Vitesse de coupe Schnittgeschwindigkeit Cutting speed	(m/min)	Vc =	$\frac{D \times \pi \times n}{1000}$
Nombre de tours Umdrehungen Rotations	(U/min)	n =	$\frac{Vc \times 1000}{\pi \times D}$
Avance par dent Vorschub pro Zahn Cutting feed per tooth	(mm/tooth)	fz =	$\frac{Vf}{n \times Z}$
Vitesse d'avance Vorschubgeschwindigkeit Cutting feed	(mm/min)	Vf =	fz x Z x n
Débit d'enlèvement de copeaux Spanvolumen Removal of cutting up shaving	(mm ³ /min)	Q =	ap x ae x Vf
Avance par tour Vorschub pro Umdrehung Cutting feed per rotation	(mm/U)	f =	$\frac{Vf}{n}$

Nos propositions techniques s'appliquent à la plupart des utilisations courantes.

N'hésitez pas à nous contacter pour des conseils plus précis.

Diese technische Empfehlungen gelten für die Mehrzahl der Standardanwendungen.

Unsere Techniker beraten Sie gerne für spezifische Anliegen.

These technical propositions apply to the majority of standard usages.

Do not hesitate to contact us for more specific advices.

CIRCO-LINE

APPLITEC





Définition du nombre de dents
Empfohlene Zähnezahl
Recommended number of teeth > **15.02**

Conseils d'utilisation
Anwendungsempfehlungen
Application recommendations > **15.03**

Fraises circulaires en métal dur – denture fine
VHM-Kreissägeblätter – feine Verzahnung
Solid carbide slitting saws – fine teeth
Type 1101  > **15.04**

Fraises circulaires en métal dur – denture grossière
VHM-Kreissägeblätter – grobe Verzahnung
Solid carbide slitting saws – large teeth
Type 1102  > **15.06**

Fraises circulaires en métal dur – denture extra-fine
VHM-Kreissägeblätter – extra feine Verzahnung
Solid carbide slitting saws – extra fine teeth
Type 1103  > **15.08**

Fraises circulaires en métal dur - denture INOX
VHM-Kreissägeblätter - INOX Verzahnung
Solid carbide slitting saws - INOX teeth
Type 1104  > **15.10**

Exécutions spéciales
Sonderanfertigungen
Special executions  > **15.11**

Disques en métal dur rectifiés
Fertig geschliffene VHM-Ronden
Fully ground solid carbide discs
Type 1106  > **15.12**

Tasseaux porte-fraise avec serrage avant
Fräsdorne mit Spannung von vorne
Milling arbors with front clamping
Type 2810 / 2811 / 2815  > **15.16**

Tasseaux porte-fraise avec serrage arrière
Fräsdorne mit Spannung von hinten
Milling arbors with rear clamping
Type 2820 / 1820  > **15.17**

Définition du nombre de dents

Empfohlene Zähnezahl

Recommended number of teeth

OK

Idéalement 2-3 dents en contact
Im Idealfall 2-3 Zähne im Einsatz
Ideally 2-3 teeth in contact

KO

Trop de dents = avance trop faible par dent / pas assez de place pour le copeau
Trop peu de dents = risque de vibration / usure prématurée

Zu viele Zähne = zu geringer Vorschub pro Zahn / zu kleiner Spanraum
Zu wenig Zähne = Vibrationen / Verschleissrisiko

Too many teeth = feed too low per tooth / not enough place for the chips
Not enough teeth = vibration / risk of quick wearout

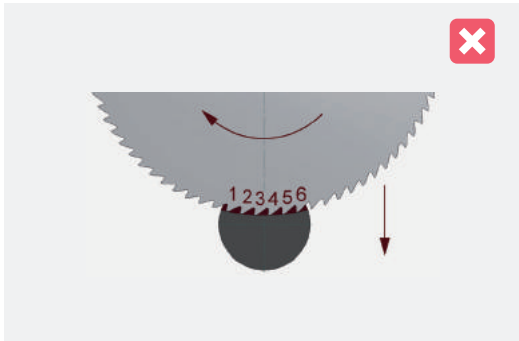
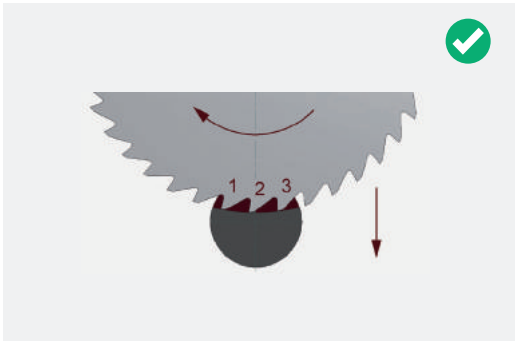
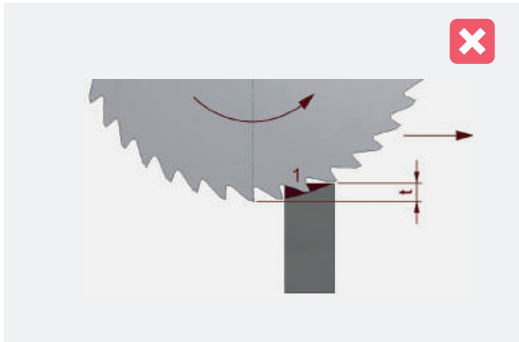
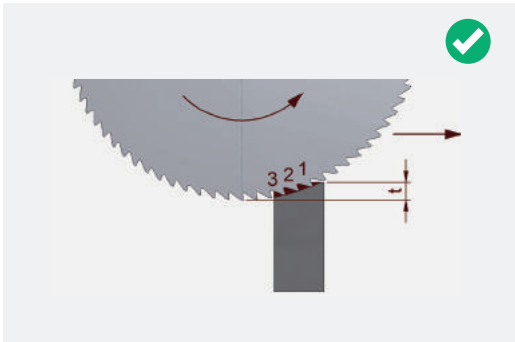
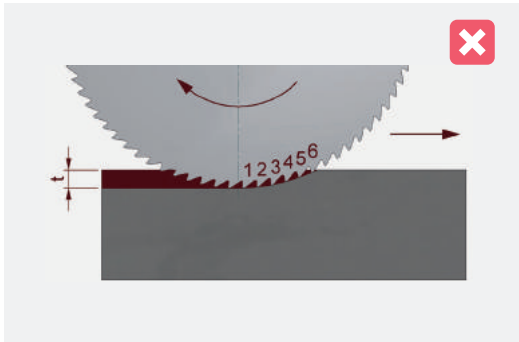
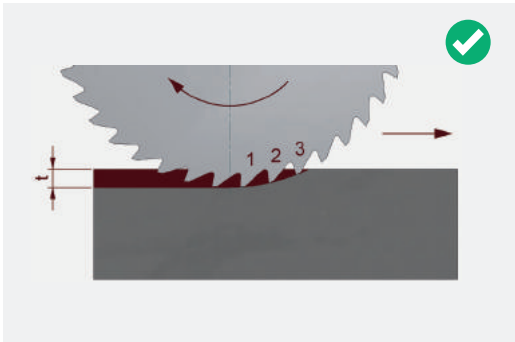

Conseils d'utilisation

Anwendungsempfehlungen

Application recommendations

		Fraises circulaires en métal dur VHM-Kreissägeblätter Solid carbide slitting saws		
Matière Werkstoff Material		Lubrifiant* Kühlung* Coolant*	VC (m/min)	Choix de la denture / avance Verzahnungswahl / Vorschub Teeth selection / cutting feed
Acier de décolletage Automatenstahl Free-cutting steel	P	O / E	120 - 240	<p>Type 1101 + 1104</p> <ul style="list-style-type: none"> • Pour usinage peu profond ou longueur à fendre faible. Avance par dent: 0.005-0.05** • Für geringe Bearbeitungstiefen oder kurze Schlitzlängen. Vorschub pro Zahn: 0.005-0.05** • For low machining depth or short slots. Feed per tooth: 0.005-0.05** <p>Type 1102</p> <ul style="list-style-type: none"> • Pour usinage profond ou grande longueur à fendre. Avance par dent: 0.01-0.1** • Für grosse Bearbeitungstiefen oder grosse Schlitzlängen. Vorschub pro Zahn: 0.01-0.1** • For deep machining or long slots. Feed per tooth: 0.01-0.1** <p>Type 1103</p> <ul style="list-style-type: none"> • Pour usinage de pièces fragiles ou fines. Avance par dent: 0.002-0.02** • Für die Bearbeitung von empfindlichen oder dünnwandigen Werkstücken. Vorschub pro Zahn: 0.002-0.02** • For machining of fragile or thin workpieces. Feed per tooth: 0.002-0.02** <p>** selon la matière, l'épaisseur ainsi que la rigidité globale ** je nach Werkstoff, Dicke und Gesamtstarrheit ** according to material, thickness and global rigidity</p>
Acier Stahl Steel < 600 N/mm ²	P	O / E	100 - 200	
Acier Stahl Steel < 800 N/mm ²	P	O / E	80 - 160	
Acier Stahl Steel < 1000 N/mm ²	P	O / E	60 - 120	
Acier Stahl Steel > 1000 N/mm ²	P	O / E	40 - 80	
Fonte Gusseisen Cast iron	K	A / E	60 - 120	
Acier inoxydable Rostfreistahl Stainless steel	M	O / E	50 - 100	
Aluminium Si < 12%	N	O / E	150 - 600	
Aluminium Si > 12%	N	O / E	80 - 300	
Cuivre, laiton, bronze Kupfer, Messing, Bronze Copper, brass, bronze	N	A / O / E	80 - 300	
Thermoplastique Thermoplaste Thermoplastics	N	A	200 - 700	
Duroplastique Duroplaste Duroplastics	N	A	150 - 600	
Acier réfractaire Warmfester Stahl Heat resistant steel	S	O / E	25 - 60	
Titane Titan Titanium	S	O / E	30 - 60	

* O = huile de coupe /Schneidöl / cutting oil

* E = Emulsion

* A = sec (air comprimé) / Trocken (Presluft) / dry (air)

avec revêtement TiN / TiCN / TiAlN, augmenter les valeurs de 20%

mit TiN / TiCN / TiAlN Beschichtung, Daten um 20% erhöhen

with TiN / TiCN / TiAlN coating, increase data by 20%

Denture fine
Feine Verzahnung
Fine teeth

DIN 1837

- Pour usinage peu profond ou longueur à fendre faible
- Für geringe Bearbeitungstiefen oder kurze Schlitzlängen
- For low machining depth or short slots
- Avance par dent: 0.005 - 0.05 mm
- Vorschub pro Zahn: 0.005 - 0.05 mm
- Feed per tooth: 0.005 - 0.05 mm
- Revêtement sur demande
- Beschichtung auf Anfrage
- Coating on request



Fraises circulaires en métal dur

VHM-Kreissägeblätter

Solid carbide slitting saws

Type 1101

Denture fine Feine Verzahnung Fine teeth												DIN 1837
D js12	15	20	25	30	40	50	63	80	100	125	160	D js12
d H7	5	5	8	8	10	13	16	22	22	22	32	d H7
Epaisseur Dicke Thickness E ±0.01	Z = Nombre de dents Zähnezahl Number of teeth										Epaisseur Dicke Thickness E ±0.01	
0.10	64	80	80	100	128							0.10
0.15	64	80	80	100	128							0.15
0.20	64	80	80	100	128	128	160					0.20
0.25	64	64	80	100	100	128	128					0.25
0.30	64	64	80	80	100	128	128	160				0.30
0.35	64	64	64	80	100	100	128	160				0.35
0.40	64	64	64	80	100	100	128	160				0.40
0.45	48	48	64	80	80	100	128	128				0.45
0.50	48	48	64	80	80	100	128	128	160			0.50
0.60	48	48	64	64	80	100	100	128	160	160		0.60
0.70	48	48	48	64	80	80	100	128	128	160		0.70
0.80	40	40	48	64	80	80	100	128	128	160		0.80
0.90	40	40	48	64	64	80	100	100	128	160		0.90
1.00	40	40	48	64	64	80	100	100	128	160	160	1.00
1.10	40	40	48	48	64	80	80	100	128	128		1.10
1.20	40	40	48	48	64	80	80	100	128	128	160	1.20
1.30	40	40	40	48	64	64	80	100	100			1.30
1.40	40	40	40	48	64	64	80	100	100	128		1.40
1.50	40	40	40	48	64	64	80	100	100	128	160	1.50
1.60	40	40	40	48	64	64	80	100	100	128	160	1.60
1.70	40	32	40	48	48	64	80	80	100			1.70
1.80	40	32	40	48	48	64	80	80	100	128	128	1.80
1.90	40	32	40	48	48	64	80	80	100			1.90
2.00	40	32	40	48	48	64	80	80	100	128	128	2.00
2.50	40	32	40	40	48	64	64	80	100	100	128	2.50
3.00	40	32	32	40	48	48	64	80	80	100	128	3.00
3.50	24	24	32	40	40	48	64	64	80	100		3.50
4.00	24	24	32	40	40	48	64	64	80	100		4.00
5.00	24	24	32	32	40	48	48	64	80	100		5.00
6.00	24	24	24	32	40	40	48	64	64	100		6.00

Denture grossière
Grobe Verzahnung
Large teeth

DIN 1838

- Pour usinage profond ou grande longueur à fendre
- Für grosse Bearbeitungstiefen oder grosse Schlitzlängen
- For deep machining or long slots
- Avance par dent: 0.01 - 0.1 mm
- Vorschub pro Zahn: 0.01 - 0.1 mm
- Feed per tooth: 0.01 - 0.1 mm
- Revêtement sur demande
- Beschichtung auf Anfrage
- Coating on request



Fraises circulaires en métal dur

VHM-Kreissägeblätter

Solid carbide slitting saws

Type 1102

Denture grossière Grobe Verzahnung Large teeth												DIN 1838
D js12	15	20	25	30	40	50	63	80	100	125	160	D js12
d H7	5	5	8	8	10	13	16	22	22	22	32	d H7
Epaisseur Dicke Thickness E ±0.01	Z = Nombre de dents Zähnezahl Number of teeth										Epaisseur Dicke Thickness E ±0.01	
0.20	20	20	20	30	40							0.20
0.25	20	20	20	30	40							0.25
0.30	20	20	20	30	40							0.30
0.40	20	20	20	30	40	48	64					0.40
0.50	20	20	20	30	40	48	64					0.50
0.60	20	20	20	30	40	48	48	64	80			0.60
0.70	20	20	20	30	40	40	48	64	64			0.70
0.80	20	20	20	24	32	40	48	64	64	80		0.80
0.90	20	20	20	24	32	40	48	48	64	80		0.90
1.00	20	20	20	24	32	40	48	48	64	80	80	1.00
1.20	20	20	20	24	32	40	40	48	64	64	80	1.20
1.50	20	20	20	24	32	32	40	48	48	64	80	1.50
1.60	20	20	20	24	32	32	40	48	48	64		1.60
1.80	20	20	20	24	24	32	40	40	48	64		1.80
2.00	20	20	20	24	24	32	40	40	48	64	80	2.00
2.50	20	20	20	24	24	32	32	40	48	48	80	2.50
3.00	20	20	20	24	24	24	32	40	40	48	64	3.00
4.00	20	20	20	24	20	24	32	32	40	48		4.00
5.00	20	20	20	24	20	24	24	32	40	40		5.00
6.00	20	20	20	24	20	20	24	32	32	40		6.00

Denture extra-fine
 Extra feine Verzahnung
 Extra fine teeth

- Pour usinage de pièces fragiles ou fines
- Avance par dent: 0.002 - 0.03 mm
- Idéal pour le décolletage
- Revêtement sur demande
- Für die Bearbeitung von empfindlichen oder dünnwandigen Werkstücken
- Vorschub pro Zahn: 0.002 - 0.03 mm
- Für Langdrehautomaten besonders empfehlenswert
- Beschichtung auf Anfrage
- For machining of fragile or thin workpieces
- Feed per tooth: 0.002 - 0.03 mm
- Recommended on automatic lathes
- Coating on request



Denture extra-fine Extra feine Verzahnung Extra fine teeth					
D js12	8	10	12	15	D js12
d H7	3	3	5	5	d H7
Epaisseur Dicke Thickness E ±0.005	$Z = \frac{\text{Nombre de dents}}{\text{Zähnezahl}} = \frac{\text{Number of teeth}}{\text{Number of teeth}}$				Epaisseur Dicke Thickness E ±0.005
0.10	48	64	64	80	0.10
0.11	48	64	64	80	0.11
0.12	48	64	64	80	0.12
0.13	48	64	64	80	0.13
0.14	48	64	64	80	0.14
0.15	48	64	64	80	0.15
0.16	48	64	64	80	0.16
0.17	48	64	64	80	0.17
0.18	48	64	64	80	0.18
0.19	48	64	64	80	0.19
0.20	48	64	64	80	0.20

Fraises circulaires en métal dur

VHM-Kreissägeblätter

Solid carbide slitting saws

Type 1103

Denture extra-fine Extra feine Verzahnung Extra fine teeth													
D js12	8	10	12	15	20	20	20	25	25	25	30	32	D js12
d H7	3	3	5	5	5	5	6	5	6	8	8	8	d H7
Epaisseur Dicke Thickness E ±0.01	$Z =$ Nombre de dents Zähnezahl Number of teeth											Epaisseur Dicke Thickness E ±0.01	
0.10	**	**	**	**			100	80	80				0.10
0.15	**	**	**	**			100	80	80	100	100	80	0.15
0.20	**	**	**	**	*		100	80	80	100	100	* 80	0.20
0.25	48	64	64	80	80		100	80	80	100	100	* 80	0.25
0.30	48	64	64	80	80		100	80	80	100	100	80	0.30
0.35	48	64	64	80	80			80	80	100	100	80	0.35
0.40	48	64	64	80	80		100	80	80	100	100	80	0.40
0.50	48	64	64	80	80		100	80	80	100	100	80	0.50
0.60	48	64	64	80	80			80	80	100	100	80	0.60
0.70	48	64	64	80	80			80	80	100	100	80	0.70
0.80	48	64	64	80	80			80	80	100	100	80	0.80
0.90	48	64	64	80	80			80	80	100	100	80	0.90
1.00	48	64	64	80	80			80	80	100	100	80	1.00
1.20				80	80			80	80	100	100	80	1.20
1.50				80	80			80	80	100	100	80	1.50
2.00				80	80			80	80	100	100	80	2.00
2.50				80	80			80	80	100	100	80	2.50
3.00				80	80			80	80	100	100	80	3.00

D js12	35	40	40	40	40	45	45	50	50	63	80	D js12
d H7	8	8	8	10	10	8	8	10	13	16	16	d H7
0.10												0.10
0.15	96	100	160	100	160	100	160					0.15
0.20	96	100	160	100	160	100	160	100				0.20
0.25	96	100	160	*	160	100	160	100	120	120		0.25
0.30	96	100	160	*	160	100	160	100	120	120		0.30
0.35	96	100	160	*	160	100	160	100	120	120		0.35
0.40	96	100	160	*	160	100	160	100	120	120		0.40
0.50	96	100	160	100	160	100	160	100	120	120	128	0.50
0.60	96	100	160	100	160	100	160	100	120	120	128	0.60
0.70	96	100	160	100	160	100	160	100	120	120	128	0.70
0.80	96	100	160	100	160	100	160	100	120	120	128	0.80
0.90	96	100	160	100	160	100	160	100	120	120	128	0.90
1.00	96	100	160	100	160	100	160	100	120	120	128	1.00
1.20	96	100	160	100	160	100	160	100	120	120	128	1.20
1.50	96	100	160	100	160	100	160	100	120	120	128	1.50
2.00	96	100	160	100	160	100	160	100	120	120	128	2.00
2.50	96	100	160	100	160	100	160	100	120	120	128	2.50
3.00	96	100	160	100	160	100	160	100	120	120	128	3.00

** voir page 15.08 / siehe Seite 15.08 / see page 15.08

* voir type 1101 / siehe Typ 1101 / see type 1101

Denture fine
Feine Verzahnung
Fine teeth

DIN 1837

- Pour usinage peu profond ou longueur à fendre faible
- Für geringe Bearbeitungstiefen oder kurze Schlitzlängen
- For low machining depth or short slots
- Avance par dent: 0.005 - 0.05 mm
- Vorschub pro Zahn: 0.005 - 0.05 mm
- Feed per tooth: 0.005 - 0.05 mm

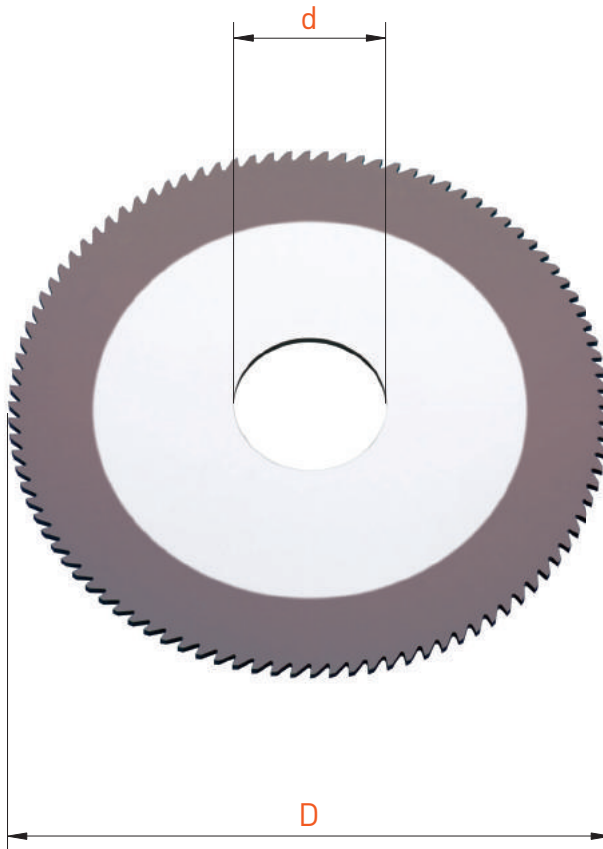

Fraises circulaires en métal dur

VHM-Kreissägeblätter

Solid carbide slitting saws

Type 1104

Denture INOX INOX Verzahnung INOX teeth				DIN 1837	
D js12	63	80	100	D js12	MAXINOX
d H7	16	22	22	d H7	
Epaisseur Dicke Thickness E ±0.01	Z = Nombre de dents Zähnezahl Number of teeth			Epaisseur Dicke Thickness E ±0.01	
0.80	80	100	120	0.80	■
1.00	80	100	120	1.00	■

Exécutions spéciales

Sonderanfertigungen

Special executions

- Denture forme B
- Denture forme W
- Train de fraises
- Alésage avec entrée de clavette
- Autres exécutions spéciales sur demande
- Revêtement sur demande
- B Zahnform
- W Zahnform
- Spezielle Kreissägeblätter im Satz
- Bohrung mit Keilnute
- Andere Sonderanfertigungen auf Anfrage
- Beschichtung auf Anfrage
- Tooth form B
- Tooth form W
- Special slitting saws in set
- Bore with keyway
- Other special executions on request
- Coating on request

Prêt pour le taillage de la denture
Bereit zum Verzahnen
Ready for teeth grinding

- Finition poli miroir des deux faces avec dépouille
- Alésage tolérance H7
- Diamètre surdimensionné ~0.15 mm
- Hochglanz Seiten mit Hohlchliff
- H7 Bohrung Toleranz
- Aussendurchmesser mit ~0.15 mm Übermass
- Mirror finish on both sides with clearance
- Bore with H7 tolerance
- Outside diameter with ~0.15 mm oversize



Disques en métal dur rectifiés

Fertig geschliffene VHM-Ronden

Fully ground solid carbide discs

Ø 8-35 mm

Type 1106

Prêt pour le taillage de la denture Bereit zum Verzahnen Ready for teeth grinding													
D +0.15/0	8	10	12	15	20	20	25	25	25	30	32	35	D ±0.15
d H7	3	3	5	5	5	6	5	6	8	8	8	8	d H7
Epaisseur Dicke Thickness E ±0.01	Epaisseurs et alésages spéciaux sur demande Andere Dicken und Bohrungen auf Anfrage Other thicknesses and bores on request											Epaisseur Dicke Thickness E ±0.01	
0.10	■	■	■	■	■	■	■	■	■	■			0.10
0.15	■	■	■	■	■	■	■	■	■	■	■	■	0.15
0.20	■	■	■	■	■	■	■	■	■	■	■	■	0.20
0.25	■	■	■	■	■	■	■	■	■	■	■	■	0.25
0.30	■	■	■	■	■	■	■	■	■	■	■	■	0.30
0.35	■	■	■	■	■	■	■	■	■	■	■	■	0.35
0.40	■	■	■	■	■	■	■	■	■	■	■	■	0.40
0.45	□	□	□	■	■	■	■	□	■	■	□	■	0.45
0.50	■	■	■	■	■	■	■	■	■	■	■	■	0.50
0.60	■	■	■	■	■	■	■	■	■	■	■	■	0.60
0.70	■	■	■	■	■	■	■	■	■	■	■	■	0.70
0.80	■	■	■	■	■	■	■	■	■	■	■	■	0.80
0.90	■	■	■	■	■	■	■	■	■	■	■	■	0.90
1.00	■	■	■	■	■	■	■	■	■	■	■	■	1.00
1.10			□	■	■	□	□	□	■	■	□	□	1.10
1.20			□	■	■	■	■	■	■	■	■	■	1.20
1.30			□	■	■	□	□	□	■	■	□	□	1.30
1.40			□	■	■	□	□	□	■	■	□	□	1.40
1.50			■	■	■	■	■	■	■	■	■	■	1.50
1.60				■	■	□	□	□	■	■	□	□	1.60
1.70				■	■	□	□	□	■	■	□	□	1.70
1.80				■	■	□	□	□	■	■	□	□	1.80
1.90				■	■	□	□	□	■	■	□	□	1.90
2.00				■	■	■	■	■	■	■	■	■	2.00
2.50				■	■	■	■	■	■	■	■	■	2.50
3.00				■	■	■	■	■	■	■	■	■	3.00
3.50				□	□				□	□			3.50
4.00				□	□				□	□			4.00
5.00				□	□				□	□			5.00
6.00				□	□				□	□			6.00

■ = disponible / verfügbar / available

□ = selon disponibilité du stock / jenach Lagerverfügbarkeit / depending on stock availability

Prêt pour le taillage de la denture
Bereit zum Verzahnen
Ready for teeth grinding

- Finition poli miroir des deux faces avec dépouille
- Alésage tolérance H7
- Diamètre surdimensionné ~0.15 mm
- Hochglanz Seiten mit Hohlchliff
- H7 Bohrung Toleranz
- Aussendurchmesser mit ~0.15 mm Übermass
- Mirror finish on both sides with clearance
- Bore with H7 tolerance
- Outside diameter with ~0.15 mm oversize

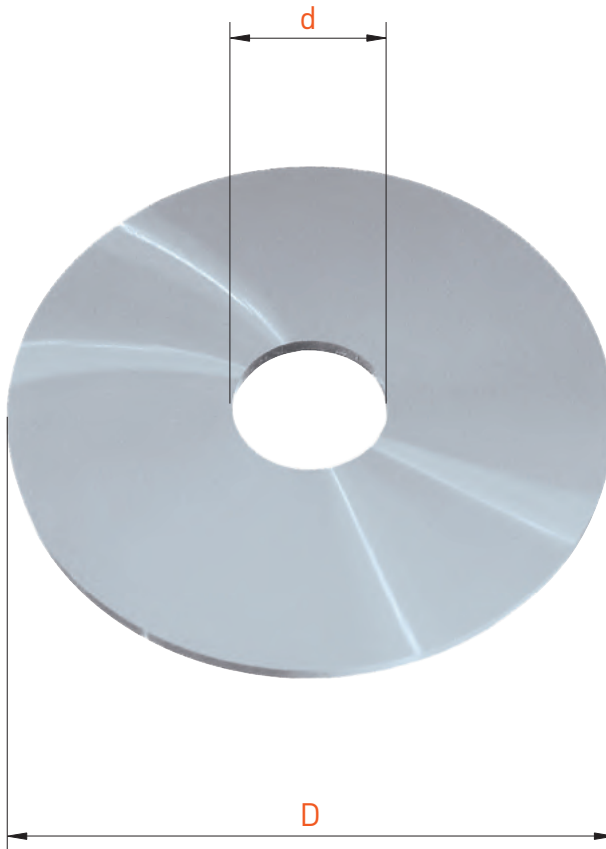

Disques en métal dur rectifiés

Fertig geschliffene VHM-Ronden

Fully ground solid carbide discs

Ø 40-160 mm

Type 1106

Prêt pour le taillage de la denture Bereit zum Verzahnen Ready for teeth grinding													
D +0.15/0	40	40	45	50	50	63	80	80	100	125	160	160	D ±0.15
d H7	8	10	8	10	13	16	16	22	22	22	22	32	d H7
Epaisseur Dicke Thickness E ±0.01	Epaisseurs et alésages spéciaux sur demande Andere Dicken und Bohrungen auf Anfrage Other thicknesses and bores on request											Epaisseur Dicke Thickness E ±0.01	
0.10		■											0.10
0.15	■	■	■										0.15
0.20	■	■	■	■	■	■							0.20
0.25	■	■	■	■	■	■							0.25
0.30	■	■	■	■	■	■		■					0.30
0.35	■	■	■	■	■	■		■					0.35
0.40	■	■	■	■	■	■		■					0.40
0.45	■	■	□	□	■	■		■					0.45
0.50	■	■	■	■	■	■	■	■	□				0.50
0.60	■	■	■	■	■	■	■	■	□	□			0.60
0.70	■	■	■	■	■	■	■	■	□	□			0.70
0.80	■	■	■	■	■	■	■	■	□	□			0.80
0.90	■	■	■	■	■	■	■	■	□	□			0.90
1.00	■	■	■	■	■	■	■	■	□	□		□	1.00
1.10	□	■	□	□	■	■	□	■	□	□		□	1.10
1.20	■	■	■	■	■	■	■	■	□	□	□	□	1.20
1.30	■	■	□	□	■	■	□	■	□	□		□	1.30
1.40	■	■	□	□	■	■	□	■	□	□		□	1.40
1.50	■	■	■	■	■	■	■	■	□	□	□	□	1.50
1.60	□	■	□	□	■	■	□	□	□	□		□	1.60
1.70	□	■	□	□	■	■	□	□	□	□		□	1.70
1.80	□	■	□	□	■	■	□	□	□	□		□	1.80
1.90	□	■	□	□	■	■	□	□	□	□		□	1.90
2.00	■	■	■	■	■	■	□	□	□	□		□	2.00
2.50	■	■	■	■	■	■	□	□	□	□		□	2.50
3.00	■	■	■	■	■	■	□	□	□	□		□	3.00
3.50		□			□	□		□	□	□			3.50
4.00		□			□	□		□	□	□			4.00
5.00		□			□	□		□	□	□			5.00
6.00		□			□	□		□	□	□			6.00

■ = disponible / verfügbar / available

□ = selon disponibilité du stock / jenach Lagerverfügbarkeit / depending on stock availability

Tasseaux porte-fraise avec serrage avant
 Fräsdorne mit Spannung von vorne
 Milling arbors with front clamping

Type 2810 / 2811 / 2815

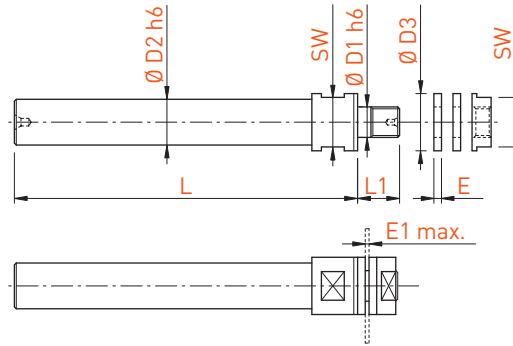

Type 2810	Rotation à droite (filet à droite) Drehrichtung rechts (Rechtsgewinde) Right hand rotation (right hand thread)							
D1 h6	D2 h6	D3	L	L1	E	SW	E1 max.	Art. N°
5.0	6.0	10.0	70	9.0	2.0	8.0	6.0	2810-5-6
5.0	10.0	10.0	80	9.0	2.0	8.0	6.0	2810-5-10
6.0	10.0	12.0	80	9.5	2.0	10.0	6.0	2810-6-10
8.0	10.0	15.0	80	10.0	2.0	13.0	6.0	2810-8-10
8.0	12.0	15.0	90	10.0	2.0	13.0	6.0	2810-8-12
10.0	6.0	18.0	80	10.5	2.0	15.0	6.0	2810-10-6
10.0	10.0	18.0	80	10.5	2.0	15.0	6.0	2810-10-10
10.0	16.0	18.0	100	10.5	2.0	15.0	6.0	2810-10-16
13.0	16.0	22.0	110	11.0	2.0	19.0	6.0	2810-13-16
16.0	20.0	26.0	120	12.0	2.0	22.0	6.0	2810-16-20
22.0	16.0	32.0	120	12.0	2.0	27.0	6.0	2810-22-16

Type 2811	Rotation à droite (filet à droite) Drehrichtung rechts (Rechtsgewinde) Right hand rotation (right hand thread)							
D1 h6	D2 h6	D3	L	L1	E	SW	E1 max.	Art. N°
16.0	10.0	22.0	80	8.0	2.0	19.0	3.0	2811-16-10

Type 2815	Pour petites fraises circulaires (filet à droite) Für kleine Kreissägebblätter (Rechtsgewinde) For small slitting saws (right hand thread)							
D1 h6	D2 h6	D3	L	L1	E	SW	E1 max.	Art. N°
3.0	5.0	5.0	60	7.0	1.0	4.0	3.0	2815-3-5
5.0	6.0	7.5	70	7.0	1.0	6.0	3.0	2815-5-6

Tasseaux porte-fraise avec serrage arrière

Fräsdorne mit Spannung von hinten

Milling arbors with rear clamping

Type 2820 / 1820

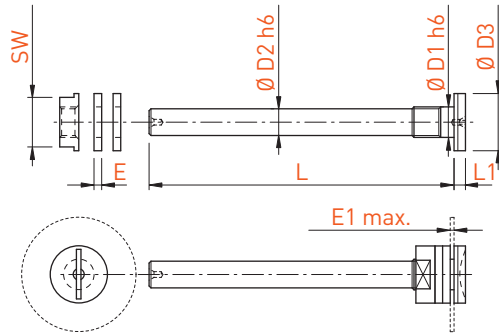

Type 2820	Rotation à droite (filet à gauche) Drehrichtung rechts (Linksgewinde) Right hand rotation (left hand thread)							
	D1 h6	D2 h6	D3	L	L1	E	SW	E1 max.
5.0	4.0	10.0	50	3.0	2.0	8.0	6.0	2820-5-4
6.0	5.0	12.0	60	3.0	2.0	10.0	6.0	2820-6-5
8.0	6.0	15.0	80	3.0	2.0	13.0	6.0	2820-8-6
8.0	7.0	15.0	80	3.0	2.0	13.0	6.0	2820-8-7
10.0	6.0	18.0	70	3.5	2.0	15.0	6.0	2820-10-6
10.0	8.0	18.0	90	3.5	2.0	15.0	6.0	2820-10-8
13.0	10.0	22.0	110	3.5	2.0	19.0	6.0	2820-13-10
16.0	12.0	26.0	120	3.5	2.0	22.0	6.0	2820-16-12

Type 1820	Rotation à gauche (filet à droite) Drehrichtung links (Rechtsgewinde) Left hand rotation (right hand thread)							
	D1 h6	D2 h6	D3	L	L1	E	SW	E1 max.
5.0	4.0	10.0	50	3.0	2.0	8.0	6.0	1820-5-4
6.0	5.0	12.0	60	3.0	2.0	10.0	6.0	1820-6-5
8.0	6.0	15.0	70	3.0	2.0	13.0	6.0	1820-8-6
10.0	6.0	18.0	70	3.5	2.0	15.0	6.0	1820-10-6

Chaque tasseau est livré avec 2 entretoises et 1 écrou

Jeder Fräsdorn wird mit 2 Abstandsringen und 1 Mutter geliefert

2 distance rings and 1 nut are included with each arbor

Pièces de rechange Ersatzteile Spare parts	E	Art. N°	Art. N°
	2	2810-D1*-A	2810-D1*-B
	2	2811-D1*-A	2811-D1*-B
	1	2815-D1*-A	2815-D1*-B
	2	2820-D1*-A	2820-D1*-B

* Diamètre D1 à spécifier * Durchmesser D1 angeben * Diameter D1 to be specified



Réduisez le temps de changement d'outil jusqu'à 75%!
Reduzieren Sie die Wechselzeit Ihrer IK-Halter um bis zu 75%!
Reduce tool change time by up to 75%!

Le système de distribution de réfrigérant Applitec JET-LINE est conçu pour tirer parti de tous les avantages offerts par le refroidissement à haute pression jusqu'à 220 bar. Associé à nos porte-outils, il permet des préparations rapides et flexibles tout en garantissant l'orientation et la quantité correcte de débit de l'agent de refroidissement directement sur l'outil de coupe!

Mit dem Applitec Hochdruckkühlmittelsystem JET-LINE profitieren Sie von einer effizienten Kühlmittelversorgung Ihrer IK-Werkzeuge bis zu 220 bar. In Verbindung mit den IK-Haltern von Applitec wird ein schneller, und flexibler Werkzeugwechsel ermöglicht!

Applitec JET-LINE coolant distribution system is designed to maximise the benefits and advantages offered by high pressure coolant up to 220 bar. Associated to our holders with intergrated coolant, the quick change and flexible system reduces set up times without compromising the correct orientation and quantity of coolant flow directly to the cutting tool!

Les avantages

Die Vorteile

The advantages

Changement rapide Schnellwechselsystem Quick change

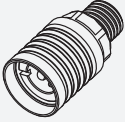

Réduit le temps de préparation et garantit le repositionnement des sorties de liquide de refroidissement
Verkürzung der Rüstzeiten bei gleicher Position der Kühlmittelauslässe
Reduces set up times with coolant outlets remain in the same position

Refroidissement à haute pression Hochdruck abgekühlt High pressure



Tuyaux flexibles renforcés garantis jusqu'à 220 bar !
Hochdruck verstärkten Schläuchen bis 220 bar !
High pressure flexible reinforced hoses up to 220 bar!

Facilité d'adaptation Einfache Anpassungsmöglichkeiten Easy to adapt

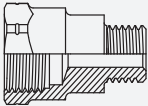

Adaptateur disponible pour filetage M5, M6, M8X1 and BSP1/8
Adapter für M5, M6, M8X1 und BSP1/8 erhältlich
Adaptors available for M5, M6, M8X1, and BSP1/8 thread

Multiples possibilités de connexion Vielfältige Anschlussoptionen Large range of connection possibilities

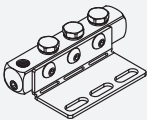





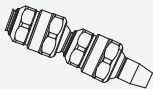





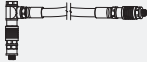



Vaste gamme de connecteurs pour tous les types de machines
Grosse Auswahl von Anschlüsse für alle Machinentypen
Huge range of possible coolant connections to suit all machine types

Système articulé Gelenksystem Articulated system



Module flexible d'arrosage en acier pour une meilleure stabilité
Flexibler Stahlkühlmittelmodul für eine bessere Stabilität
Flexible steel coolant unit for better stability





Augmentation de la durée de vie et une meilleure efficacité de l'outil dû au contrôle des copeaux
JET-LINE steigert die Lebensdauer der Werkzeuge und verbessert die Spankontrolle
Increased tool life with better swarf control

JKIT			> 16.04
STARTER-KIT			> 16.12
JS	Raccords rapides Schnellkupplungen Quick connectors		> 16.14
JO	Joints d'étanchéité en cuivre Kupferdichtungsringe Copper sealing gaskets		> 16.15
JTX-AC	Tubes de distribution flexibles en acier inoxydable tressé Rostfreier Stahlflex-Schlauch Flexible distribution tubes of stainless steel braiding		> 16.16
JT-CU	Tubes de distribution en cuivre Kupferrohre Copper distribution tubes		> 16.17
JRMF	Connecteurs mâle/femelle Gewindeadapter Innen und Außengewinde Male/female connectors		> 16.18
JRFF	Connecteurs femelle/femelle Gewindeadapter Innengewinde Female connectors		> 16.20
JRMM	Connecteurs mâle/mâle Gewindeadapter Außengewinde Male connectors		> 16.21
JN	Écrous d'étanchéité Dichtungsmutter Sealing nuts		> 16.22
JNG	Bague d'étanchéité Dichtungsring Sealing ring		> 16.23
JCBF	Banjos courts femelle Kurzer Innengewindeadapter Short female Banjo		> 16.24
JCBM	Banjos courts mâle Kurzer Aussengewindeadapter Short Banjo		> 16.25
JABF	Banjos longs droits femelle Langer Innengewindeadapter Long straight female banjos		> 16.26
JABF-45°	Banjos longs coudés femelle Adapter lang 45° Innengewinde Long curved female banjos		> 16.27

JEB	Vis banjo Hohlschrauben einfach Banjo screws		> 16.28
JEB-DUO	Vis banjo double Hohlschrauben doppelt Double banjo screws		> 16.29
JVB	Fiches de verrouillage Verschlußstecker Sealing connecting plugs		> 16.30
JVF	Fiches de connexion Innengewindestecker Connecting plugs		> 16.31
JWF	Fiches de connexion fixes femelle Innengewindestecker mit Verdrehsicherung Female positioning connection plugs		> 16.32
JWM	Fiches de connexion fixes mâle Aussengewindestecker mit Verdrehsicherung Male positioning connection plugs		> 16.33
JK	Blocs de distribution Kühlmittelverteiler Distribution blocks		> 16.34
JBB	Bouchons d'étanchéité Verschlußstopfen Sealing plugs		> 16.35

Système articulé avec arrosage / Gelenksystem mit Kühlung / Articulated system with coolant



JKIT-AR	Kit articulé avec buse d'arrosage Gelenkkit mit Kühlungsdüse Articulated kit with coolant nozzle		> 16.36
JKIT-CU	Kit tube en cuivre avec buse d'arrosage Kit Kupferrohr mit Kühlungsdüse Kit copper tube with coolant nozzle		> 16.38
JAR	Système articulé Gelenksystem Articulated system		> 16.39
JRMM-AR	Connecteurs mâle/mâle Anschlüsse Aussengewinde Male connectors		> 16.40
JJ-AR	Buses Düse Nozzle		> 16.41
ACCESSOIRES			> 16.43

JET-LINE

Kit de connexion

Verbindungskit

Connection kit

Quick / Fix

M5

JKIT-M5-D4-...-QF

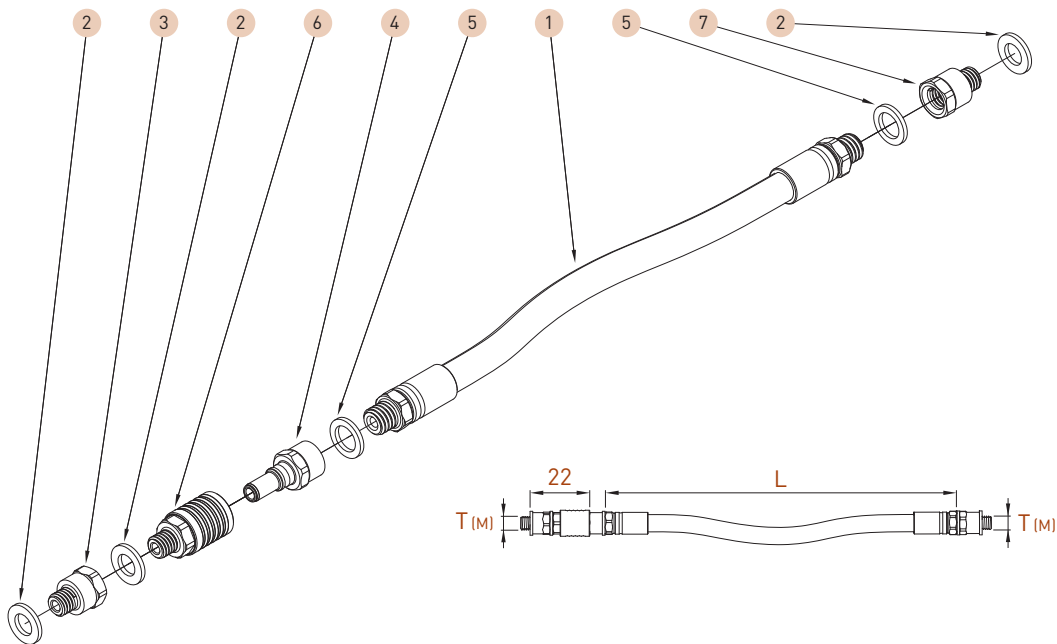

Ref	Qty	Kit composition
1	1	JTX-AC-M6-L...
2	3	JO-M5
3	1	JRMF-M5-M5-L6.5
4	1	JVF-M6-D4
5	2	JO-M6
6	1	JS-M5-D4
7	1	JRMF-M5-M6-L7.5

D	T (M)	L	Art. N°
4	M5	102	JKIT-M5-D4-102-QF
		203	JKIT-M5-D4-203-QF
		305	JKIT-M5-D4-305-QF
		406	JKIT-M5-D4-406-QF

Compatibilité
Kompatibilität
Compatibility



Porte-outil/Halter/Holder M5

ISO-Line 8X10
MODU-Line
TOP-Line 8X10
TURN-Line 8X10

Options



Art. N°

JK-M5-1010-4T

voir page 16.34
siehe Seite 16.34
see page 16.34



Art. N°

C-SW8-E2.5

voir page 16.45
siehe Seite 16.45
see page 16.45

Kit de connexion

Verbindungskit Quick / Quick

Connection kit

M5

JKIT-M5-D4-...-QQ

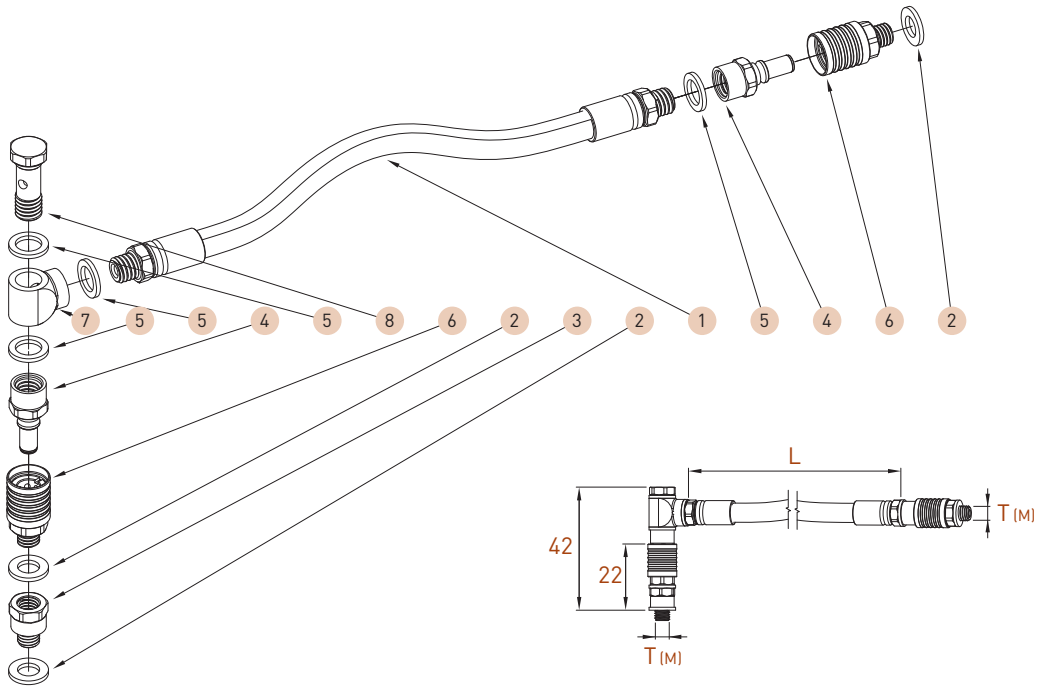

Ref	Qty	Kit composition
1	1	JTX-AC-M6-L...
2	3	JO-M5
3	1	JRMF-M5-M5-L6.5
4	2	JVF-M6-D4
5	4	JO-M6
6	2	JS-M5-D4
7	1	JCBF-Ø6-M6
8	1	JEB-M6-L19

D	T (M)	L	Art. N°
4	M5	102	JKIT-M5-D4-102-QQ
		203	JKIT-M5-D4-203-QQ
		305	JKIT-M5-D4-305-QQ
		406	JKIT-M5-D4-406-QQ

Compatibilité
Kompatibilität
Compatibility



Porte-outil/Halter/Holder M5

ISO-Line 8X10
MODU-Line
TOP-Line 8X10
TURN-Line 8X10

Options



JK-M5-1010-4T

voir page 16.34
siehe Seite 16.34
see page 16.34

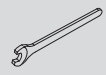

C-SW8-E2.5

voir page 16.45
siehe Seite 16.45
see page 16.45

Kit de connexion

Verbindungskit Quick / Quick

Connection kit

M6

JKIT-M6-D4-...-QQ

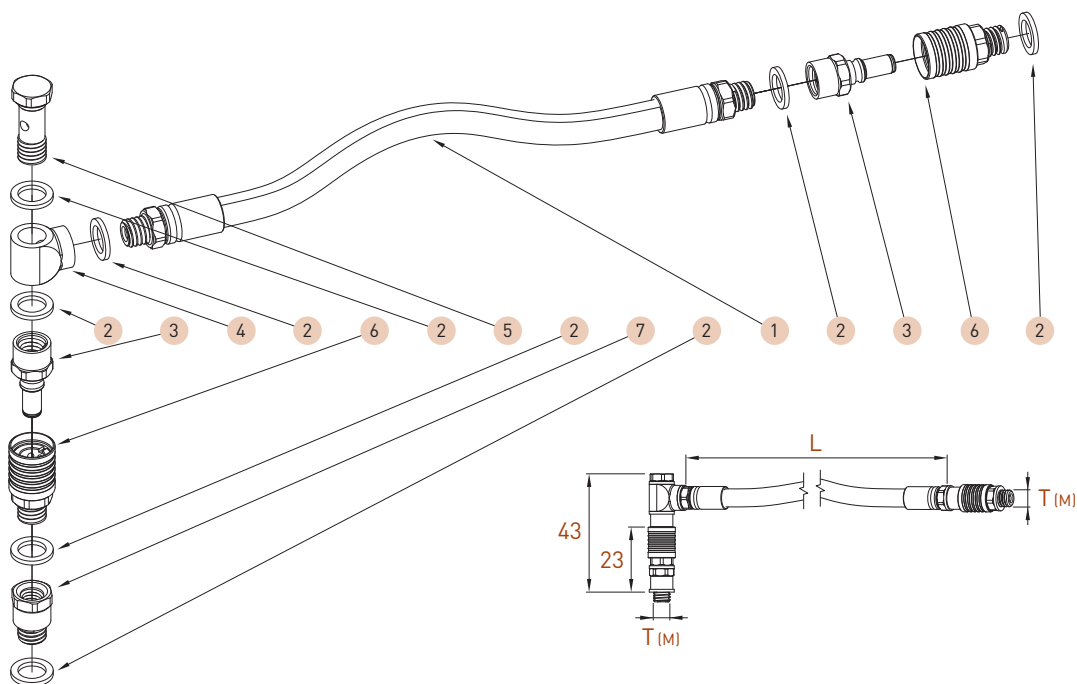

Ref	Qty	Kit composition
1	1	JTX-AC-M6-L...
2	7	JO-M6
3	2	JVF-M6-D4
4	1	JCBF-Ø6-M6
5	1	JEB-M6-L19
6	2	JS-M6-D4
7	1	JRMF-M6-M6-L7.5

D	T (M)	L	Art. N°
4	M6	102	JKIT-M6-D4-102-QQ
		203	JKIT-M6-D4-203-QQ
		305	JKIT-M6-D4-305-QQ
		406	JKIT-M6-D4-406-QQ

Compatibilité
Kompatibilität
Compatibility



Porte-outil/Halter/Holder M6

Options



Art. N°
JK-M6-1010-4T

voir page 16.34
siehe Seite 16.34
see page 16.34



Art. N°
C-SW8-E2.5

voir page 16.45
siehe Seite 16.45
see page 16.45

JET-LINE

Kit de connexion

Verbindungskit

Connection kit

Quick / Fix

M8X1

JKIT-M8X1-D6-...-QF

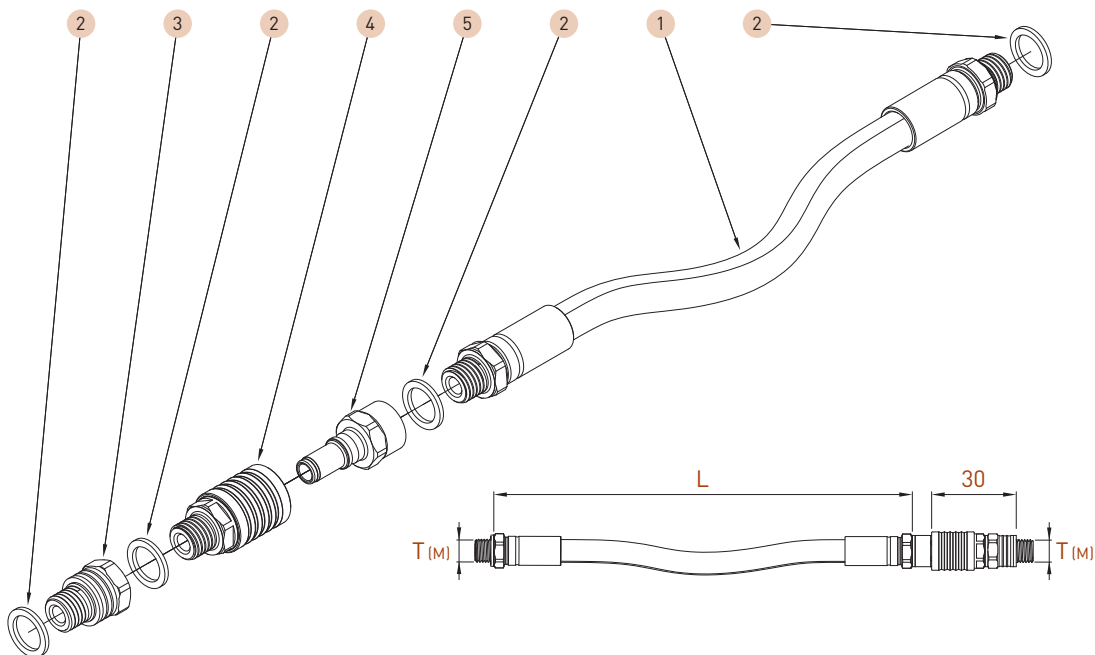

Ref	Qty	Kit composition
1	1	JTX-AC-M8X1-L...
2	4	JO-M8X1
3	1	JRMF-M8X1-M8X1-L9.5
4	1	JS-M8X1-D6
5	1	JVF-M8X1-D6

D	T (M)	L	Art. N°
6	M8X1	102	JKIT-M8X1-D6-102-QF
		203	JKIT-M8X1-D6-203-QF
		305	JKIT-M8X1-D6-305-QF
		406	JKIT-M8X1-D6-406-QF

Compatibilité Kompatibilität Compatibility	Porte-outil/Halter/Holder M8X1
	CUT-Line 16X16 - 25X25 ECO-Line 10X12 - 20X20 EVOCUT-Line 10X12 - 20X20 IN-Line Ø12 - Ø28 ISO-Line 10X10 - 20X20 MODU-Line PRO-Line 10X12 - 20X20 TOP-Line 10X12 - 20X20 TURN-Line 10X12 - 20X20

Options	Art. N°	Art. N°
	JK-M8X1-1515-4T voir page 16.34 siehe Seite 16.34 see page 16.34	C-SW11-E3.7 voir page 16.45 siehe Seite 16.45 see page 16.45

Kit de connexion

Verbindungs-kit Quick / Quick

Connection kit

M8X1

JKIT-M8X1-D6-...-QQ

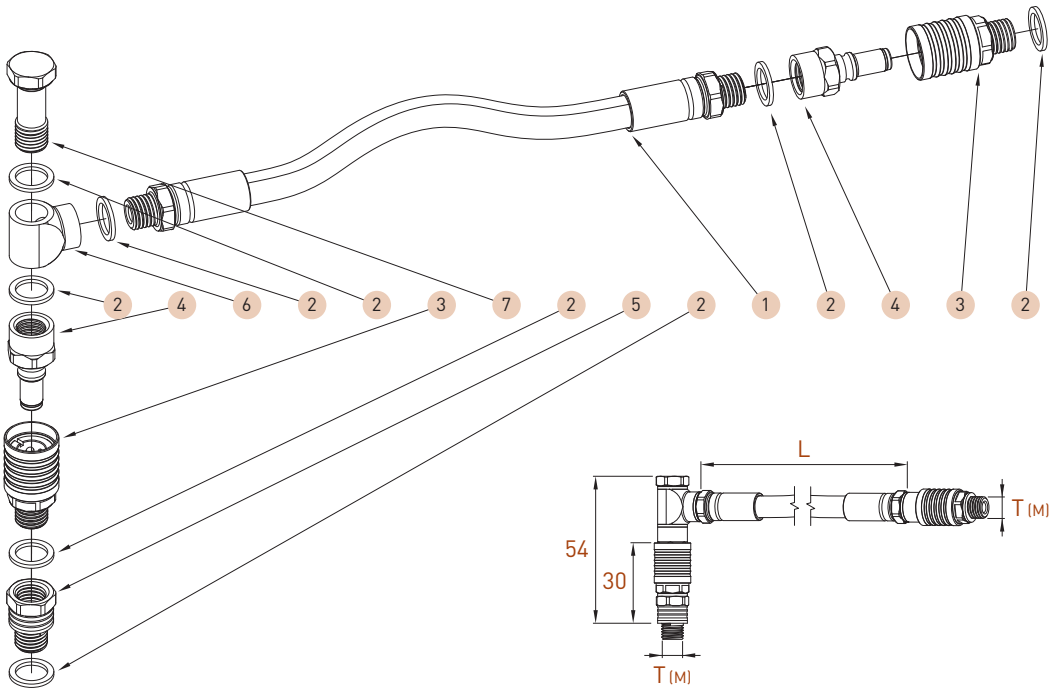

Ref	Qty	Kit composition
1	1	JTX-AC-M8X1-L...
2	7	JO-M8X1
3	2	JS-M8X1-D6
4	2	JVF-M8X1-D6
5	1	JRMF-M8X1-M8X1-L9,5
6	1	JCBF-Ø8-M8X1
7	1	JEB-M8X1-L24

D	T (M)	L	Art. N°
6	M8X1	102	JKIT-M8X1-D6-102-QQ
		203	JKIT-M8X1-D6-203-QQ
		305	JKIT-M8X1-D6-305-QQ
		406	JKIT-M8X1-D6-406-QQ

Compatibilité
Kompatibilität
Compatibility

Porte-outil/Halter/Holder M8X1

CUT-Line 16X16 - 25X25
ECO-Line 10X12 - 20X20
EVO-CUT-Line 10X12 - 20X20
IN-Line Ø12 - Ø28
ISO-Line 10X10 - 20X20
MODU-Line
PRO-Line 10X12 - 20X20
TOP-Line 10X12 - 20X20
TURN-Line 10X12 - 20X20

Options

Art. N°
JK-M8X1-1515-4T
voir page 16.34
siehe Seite 16.34
see page 16.34

Art. N°
C-SW11-E3.7
voir page 16.45
siehe Seite 16.45
see page 16.45

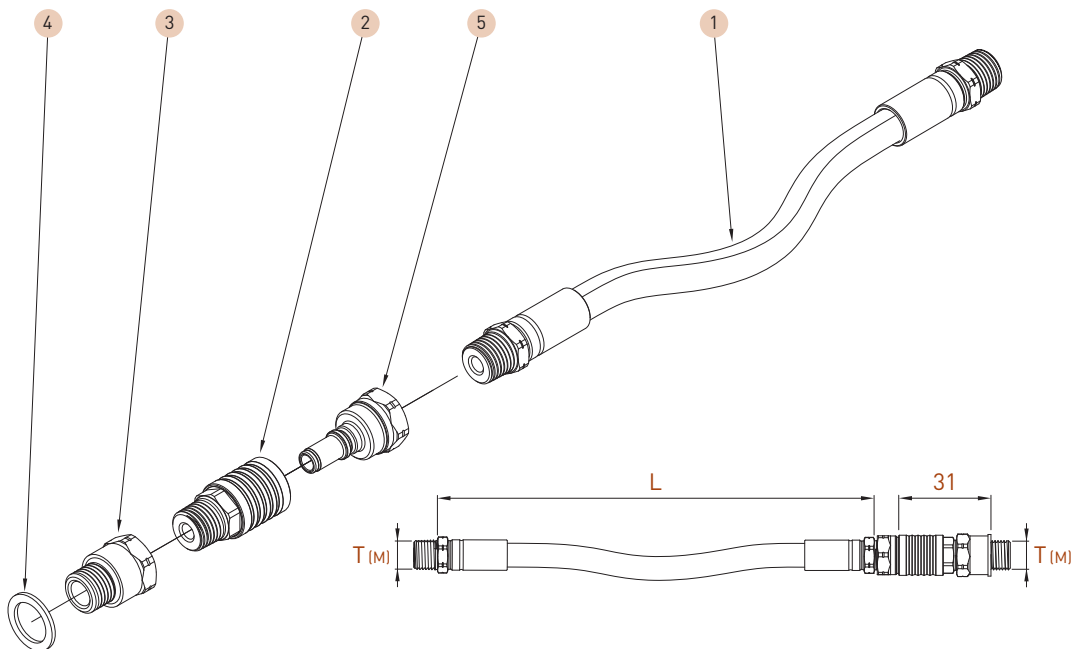

Ref	Qty	Kit composition
1	1	JTX-AC-BSPT1/8-L...
2	1	JS-BSPT1/8-D6
3	1	JRMF-BSP1/8-BSP1/8-L10.5
4	1	JO-BSP1/8
5	1	JVF-BSP1/8-D6

D	T (M)	L	Art. N°
6	BSP1/8	102	JKIT-BSP1/8-D6-102-QF
		203	JKIT-BSP1/8-D6-203-QF
		305	JKIT-BSP1/8-D6-305-QF
		406	JKIT-BSP1/8-D6-406-QF

Compatibilité
Kompatibilität
Compatibility



Porte-outil/Halter/Holder BSP1/8

Options



Art. N°

JK-BSP1/8-1515-4T

voir page 16.34
siehe Seite 16.34
see page 16.34



Art. N°

C-SW11-E3.7

voir page 16.45
siehe Seite 16.45
see page 16.45

Kit de connexion

Verbindungskit Quick / Quick

Connection kit

BSP1/8

JKIT-BSP1/8-D6-...-QQ

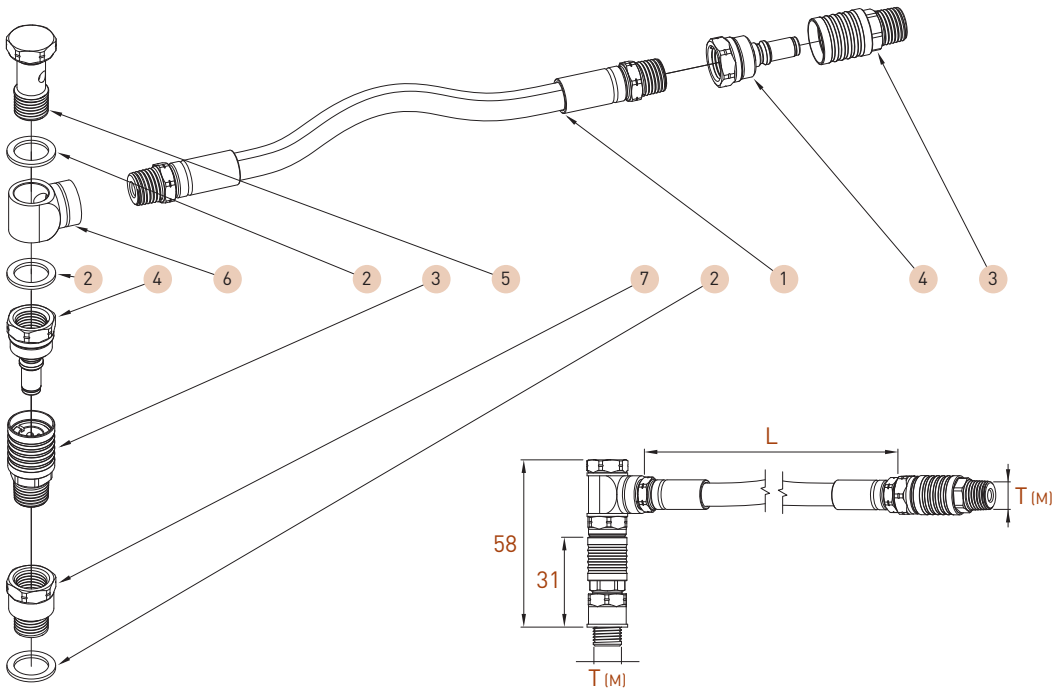

Ref	Qty	Kit composition
1	1	JTX-AC-BSPT1/8-L...
2	3	JO-BSP1/8
3	2	JS-BSPT1/8-D6
4	2	JVF-BSP1/8-D6
5	1	JEB-BSP1/8-L26
6	1	JCBF-Ø10-BSP1/8
7	1	JRMF-BSP1/8-BSP1/8-L10.5

D	T (M)	L	Art. N°
6	BSP1/8	102	JKIT-BSP1/8-D6-102-QQ
		203	JKIT-BSP1/8-D6-203-QQ
		305	JKIT-BSP1/8-D6-305-QQ
		406	JKIT-BSP1/8-D6-406-QQ

Compatibilité
Kompatibilität
Compatibility

Porte-outil/Halter/Holder BSP1/8

Options

Art. N°	Art. N°
JK-BSP1/8-1515-4T	C-SW11-E3.7
voir page 16.34 siehe Seite 16.34 see page 16.34	voir page 16.45 siehe Seite 16.45 see page 16.45



Qty	Kit composition	Art. N°
2	C-SW8-E2.5	JSTART-D4
4	JO-M6	
2	JO-M5	
2	JK-M6-1010-4T	
10	JS-M6-D4	
2	JTX-AC-M6-102	
2	JTX-AC-M6-203	
2	JTX-AC-M6-305	
2	JTX-AC-M6-406	
10	JVF-M6-D4	
2	JVB-D4	
2	JWF-M6-D4	
2	JRMF-M6-M6-L7.5	
2	JRMF-M6-M6-L12.5	
2	JRMF-M6-M6-L17.5	
10	JRMF-M5-M6-L7.5	
2	JRFF-M6-L9.0	
5	JCBF-Ø6-M6	
2	JABF-Ø6-M6-45°	
5	JEB-M6-L19	
2	JEB-M6-L30-DUO	
1	JT-CU-M6-102	
1	JT-CU-M6-203	

Starter Kit

M8X1 (+ BSP1/8)

JSTART-D6



Qty	Kit composition	Art. N°
2	C-SW11-E3.7	JSTART-D6
4	JO-M8X1	
2	JK-M8X1-1515-4T	
10	JS-M8X1-D6	
2	JTX-AC-M8X1-102	
2	JTX-AC-M8X1-203	
2	JTX-AC-M8X1-305	
2	JTX-AC-M8X1-406	
10	JVF-M8X1-D6	
2	JVB-D6	
2	JWF-M8X1-D6	
2	JRMF-M8X1-M8X1-L9.5	
2	JRMF-M8X1-M8X1-L14.5	
2	JRMF-M8X1-M8X1-L19.5	
10	JRMF-BSPT1/8-M8X1-L9.0	
2	JRFF-M8X1-L12.0	
5	JCBF-Ø8-M8X1	
2	JABF-Ø8-M8X1-45°	
5	JEB-M8X1-L24	
2	JEB-M8X1-L38-DUO	
1	JT-CU-M8X1-102	
1	JT-CU-M8X1-203	

JET-LINE

Raccord rapide
Schnellkupplungen
Quick connector

JS

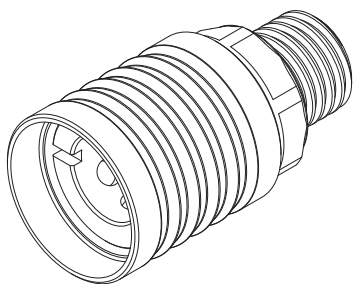
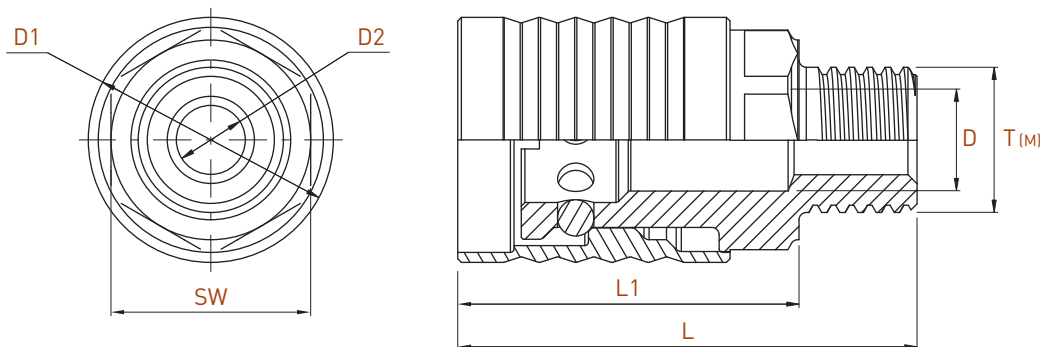

T (M)	L	L1	SW	D	D1	D2	Art. N°
M5	18	14	8	4	9.8	2.3	JS-M5-D4
M6	18	14	8	4	9.8	2.3	JS-M6-D4
M8X1KEG	20	14	8	4	9.8	2.3	JS-M8X1KEG-D4
M8X1	25	19	11	6	13.5	3.8	JS-M8X1-D6
BSPT1/8	29.3	19	11	6	13.5	3.8	JS-BSPT1/8-D6

Pression max Max. Druck max. pressure	KEG =	BSPT =
= 220 Bar (3.190 PSI)	filetage conique konisches Gewinde conical thread	filetage conique konisches Gewinde conical thread

Joint d'étanchéité en cuivre

Kupferdichtungsringe

Copper sealing gasket

JO

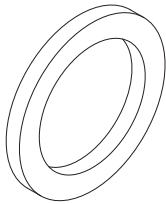
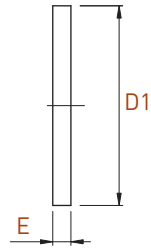
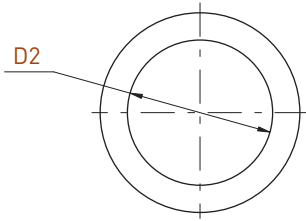

D1	D2	E	Art. N°
9	5	1	JO-M5*
9	6	1	JO-M6*
11	8	1	JO-M8X1*
14	10	1	JO-BSP1/8*

* vendu par 10 pces
 10-facherweise verkauft
 sold by 10 pcs

JET-LINE

Tube de distribution flexible en acier inoxydable tressé

Rostfreier Stahlflex-Schlauch

Flexible distribution tube of stainless steel braiding

JTX-AC

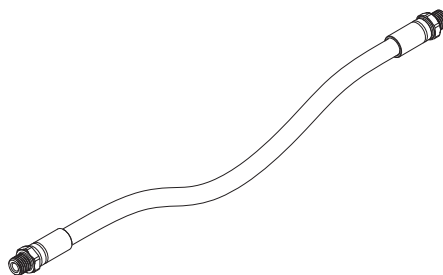
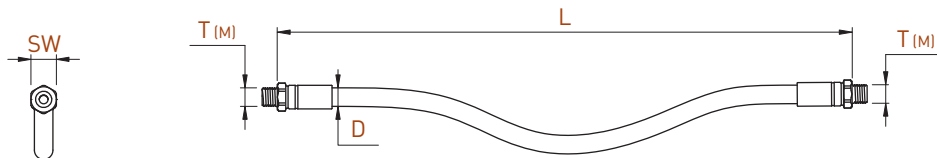

T (M)	L*	SW	D	Art. N°
M6	102	8	Ø6.5	JTX-AC-M6-102
	203	8	Ø6.5	JTX-AC-M6-203
	305	8	Ø6.5	JTX-AC-M6-305
	406	8	Ø6.5	JTX-AC-M6-406
M8X1	102	11	Ø8	JTX-AC-M8X1-102
	203	11	Ø8	JTX-AC-M8X1-203
	305	11	Ø8	JTX-AC-M8X1-305
	406	11	Ø8	JTX-AC-M8X1-406
BSPT1/8	102	11	Ø8	JTX-AC-BSPT1/8-102
	203	11	Ø8	JTX-AC-BSPT1/8-203
	305	11	Ø8	JTX-AC-BSPT1/8-305
	406	11	Ø8	JTX-AC-BSPT1/8-406

* Longueur spécifique possible sur demande
 Spezifische Länge auf Anfrage möglich
 Specific length possible on request

Pression max Max. Druck max. pressure			Pression (bar)	Ø 6.5 (l/min)	Ø 8 (l/min)
	KEG =	BSPT =			
= 220 Bar (3.190 PSI)	filetage conique	filetage conique	2	3.5	9.5
	konisches Gewinde	konisches Gewinde	8	7.0	19.0
	conical thread	conical thread	15	9.6	26.0
			20	11.0	30.1
			30	13.5	36.9
			50	17.5	47.6
			80	22.1	60.3
			100	24.7	67.4
		150	30.2	82.5	

Tube de distribution en cuivre

Kupferrohr

Copper distribution tube

JT-CU

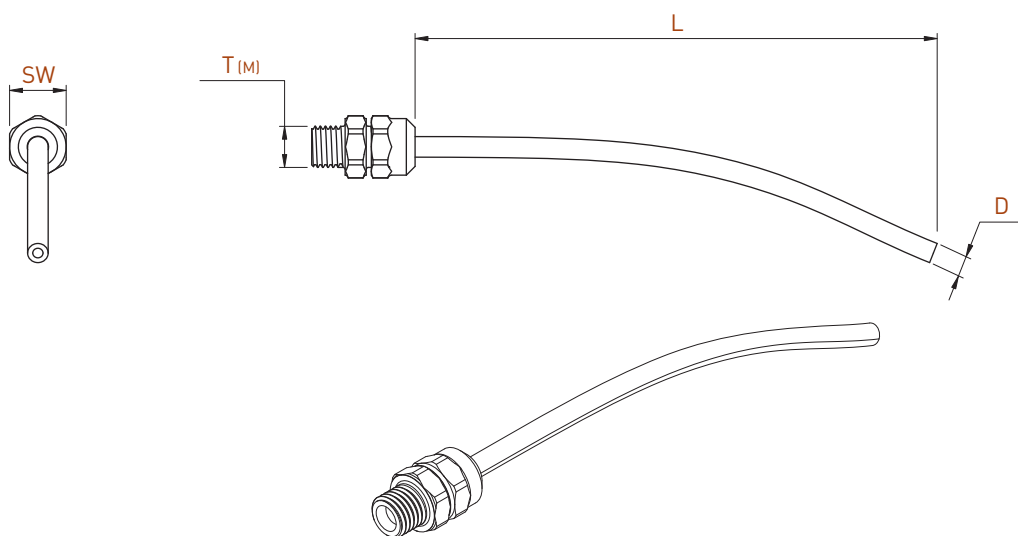

T (M)	L*	SW	D	Art. N°
M6	102	8	Ø3	JT-CU-M6-102
	203	8	Ø3	JT-CU-M6-203
	305	8	Ø3	JT-CU-M6-305
	406	8	Ø3	JT-CU-M6-406
M8X1	102	11	Ø4	JT-CU-M8X1-102
	203	11	Ø4	JT-CU-M8X1-203
	305	11	Ø4	JT-CU-M8X1-305
	406	11	Ø4	JT-CU-M8X1-406

* Longueur spécifique possible sur demande
 Spezifische Länge auf Anfrage möglich
 Specific length possible on request

Pression max
 Max. Druck
 max. pressure

= 220 Bar
 (3.190 PSI)

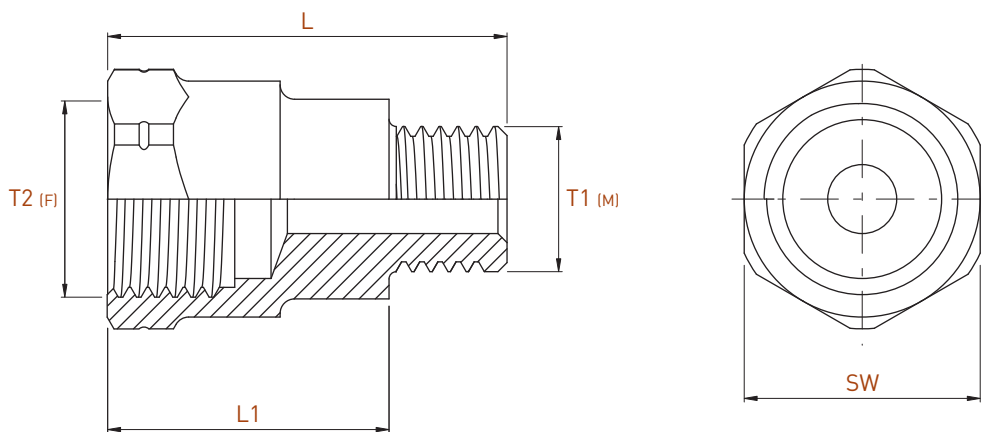

T1 (M)	T2 (F)	L1	L	SW	Art. N°	
M5	M5	6.5	11	8	JRMF-M5-M5-L6.5	
		11.5	16	8	JRMF-M5-M5-L11.5	
		16.5	21	8	JRMF-M5-M5-L16.5	
	M6	7.5	12	8	JRMF-M5-M6-L7.5	
		M8X1	9.5	14	11	JRMF-M5-M8X1-L9.5
M6	M6	7.5	12.5	8	JRMF-M6-M6-L7.5	
		12.5	17.5	8	JRMF-M6-M6-L12.5	
		17.5	22.5	8	JRMF-M6-M6-L17.5	
	M8X1	9.5	14.5	11	JRMF-M6-M8X1-L9.5	
	M8X1KEG	M6	6	12	8	JRMF-M8X1KEG-M6-L6.0
M8X1		9.5	16.5	11	JRMF-M8X1KEG-M8X1-L9.5	
M5		5.5	12	11	JRMF-M8X1-M5-L5.5	
M8X1	M6	7	13.5	11	JRMF-M8X1-M6-L7.0	
		9.5	16	11	JRMF-M8X1-M8X1-L9.5	
	M8X1	14.5	21	11	JRMF-M8X1-M8X1-L14.5	
		19.5	26	11	JRMF-M8X1-M8X1-L19.5	
		10.5	17	13	JRMF-M8X1-BSP1/8-L10.5	
		15.5	22	13	JRMF-M8X1-BSP1/8-L15.5	
		20.5	27	13	JRMF-M8X1-BSP1/8-L20.5	
		NPT1/8	11	17.5	13	JRMF-M8X1-NPT1/8-L11 new
M8X1.25	M8X1	9.5	16	11	JRMF-M8X1.25-M8X1-L9.5 new	
BSPT1/8	M5	3.5	14.6	11	JRMF-BSPT1/8-M5-L3.5	
		M6	3.5	14.6	11	JRMF-BSPT1/8-M6-L3.5
		M8X1	9	20.3	11	JRMF-BSPT1/8-M8X1-L9.0
BSP1/8	BSP1/8	10.5	18	13	JRMF-BSP1/8-BSP1/8-L10.5	
		15.5	23	13	JRMF-BSP1/8-BSP1/8-L15.5	
		20.5	28	13	JRMF-BSP1/8-BSP1/8-L20.5	
NPT1/8	M8X1	7	17	13	JRMF-NPT1/8-M8X1-L7.0 new	
	BSP1/8	9	20.3	13	JRMF-NPT1/8-BSP1/8-L9.0 new	
NPT1/16	M6	6	15	11	JRMF-NPT1/16-M6-L6.0 new	
	M8X1	9	18	13	JRMF-NPT1/16-M8X1-L9.0 new	
SAE7/16-20	M6	4.5	12	13	JRMF-SAE7/16-20-M6-L4.5 new	
		M8X1	7	14.5	13	JRMF-SAE7/16-20-M8X1-L7 new

Connecteurs mâle/femelle avec cône 60°

Innen und Außengewinde mit 60°-Kegel

Male/female connectors with cone 60°

JRMF-A60°

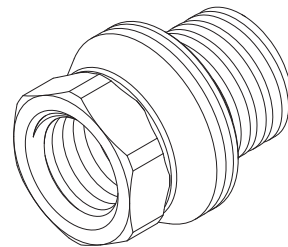
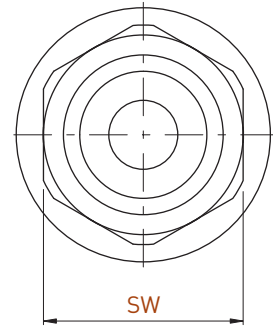
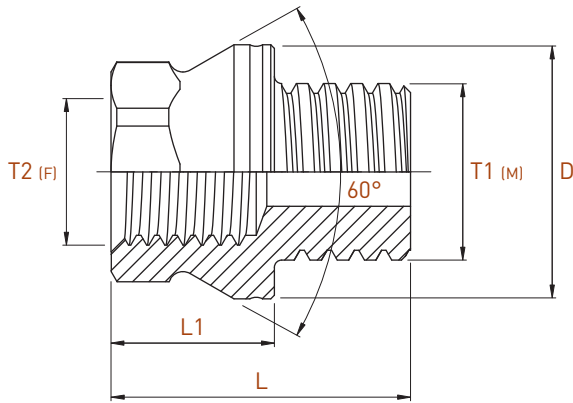

T1 (M)	T2 (F)	L1	L	D	SW	Art. N°
BSP1/8	M8X1	9	16.5	14	11	JRMF-BSP1/8-M8X1-A60°-L9.0

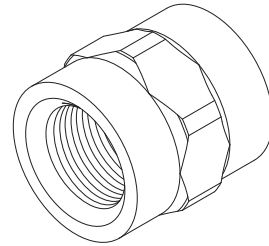
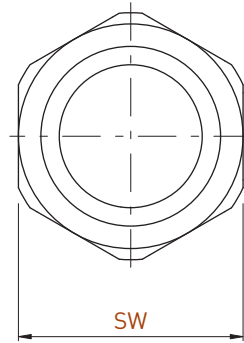
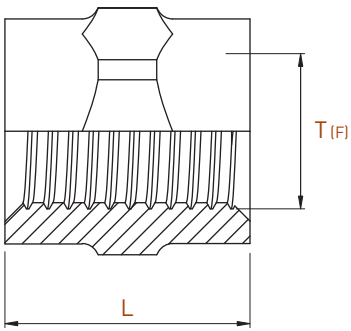

T (F)	L	SW	Art. N°
M6	9	8	JRFF-M6-L9.0
M8X1	12	11	JRFF-M8X1-L12.0

Connecteurs mâle/mâle

Gewintheadapter Außengewinde

Male connectors

JRMM

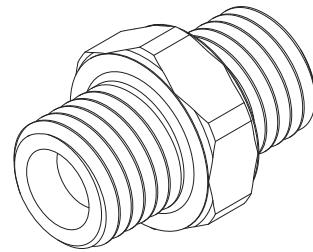
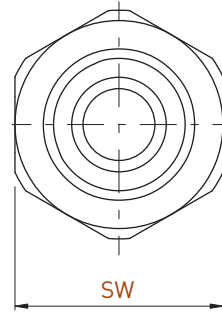
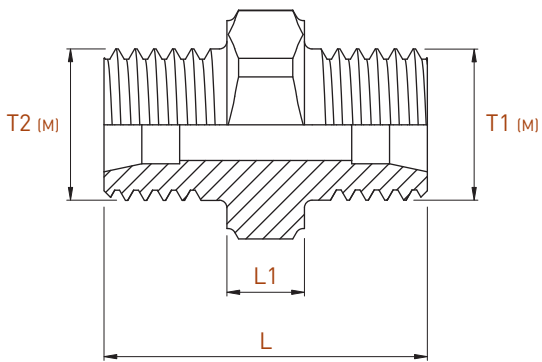

T1 (M)	T2 (M)	L1	L	SW	Art. N°
M6	M6	3	13	8	JRMM-M6-M6-L3.0
M8X1	M8X1	4	17	11	JRMM-M8X1-M8X1-L4.0
M10	M8X1	3.5	17.5	11	JRMM-M10-M8X1-3.5 new

JET-LINE

Écrous d'étanchéité

Dichtungsmutter

Sealing nuts

JN

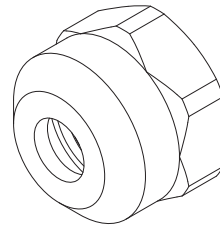
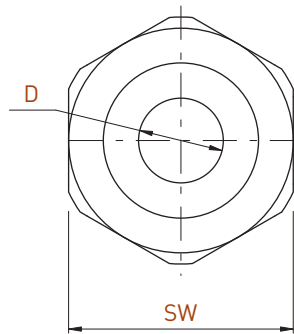
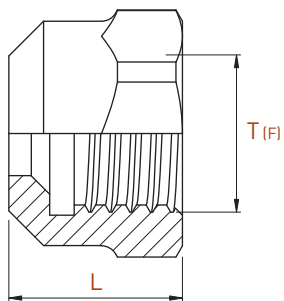

T (F)	L	D	SW	Art. N°
M6	6.5	3	8	JN-M6-D3
M8X1	8.5	4	11	JN-M8X1-D4
M10	11.5	6	12	JN-M10-D6 new

Bague d'étanchéité

Dichtungsring

Sealing ring

JNG

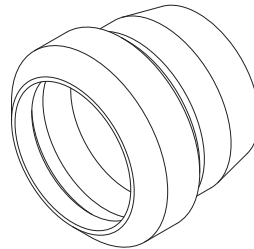
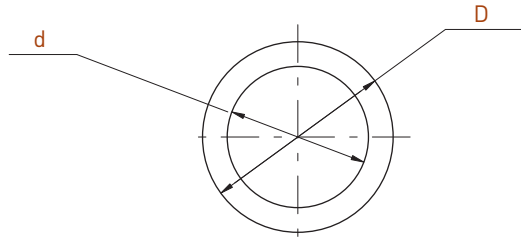
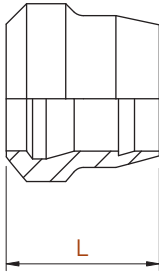

d	D	L	Art. N°
3	4	3.3	JNG-D3
4	5.5	4.5	JNG-D4
6	8.5	7	JNG-D6 new

JET-LINE

Banjos courts femelle

Kurzer Innengewintheadapter

Short female banjos

JCBF

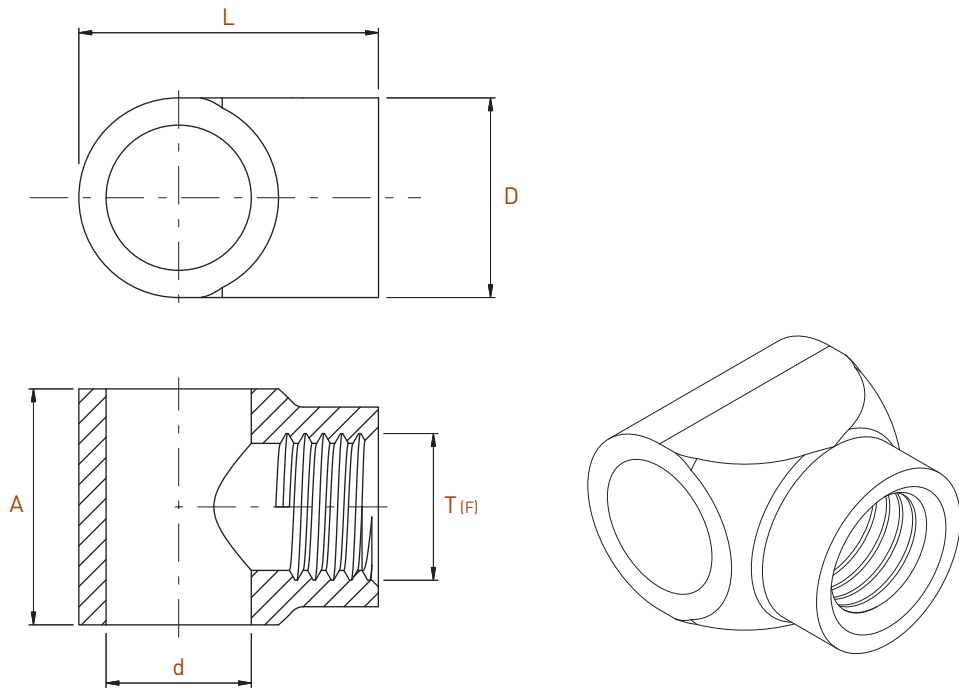

T (F)	A	L	d	D	Art. N°
M6	10	12.5	6	9	JCBF-06-M6
M8X1	13	16.5	8	11	JCBF-08-M8X1
	13	18.5	10	11	JCBF-010-M8X1
BSP1/8	13	19.5	10	13	JCBF-010-BSP1/8

Banjos courts mâle

Kurzer Aussengewindeadapter

Short male banjos

JCBM

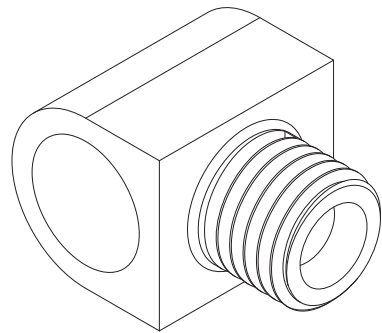
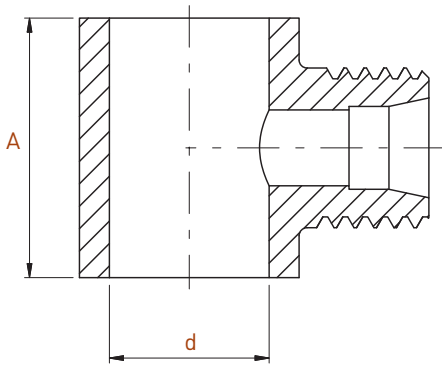
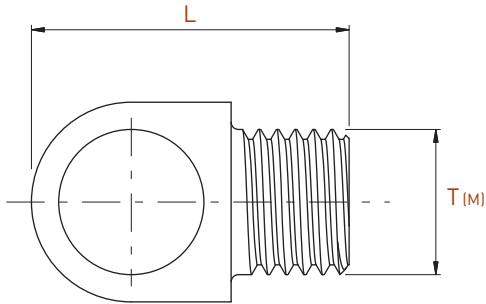

T (M)	A	L	d	Art. N°
M6	10	14	6	JCBM-Ø6-M6
M8X1	13	17.5	8	JCBM-Ø8-M8X1
	13	19.5	10	JCBM-Ø10-M8X1

JET-LINE

Banjos longs droits femelle
 Langer Innengewintheadapter
 Long straight female banjos

JABF

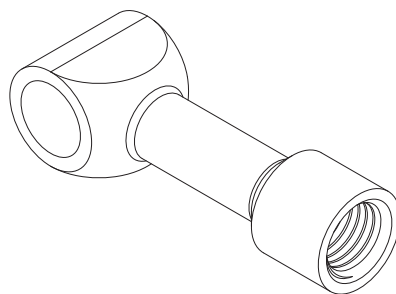
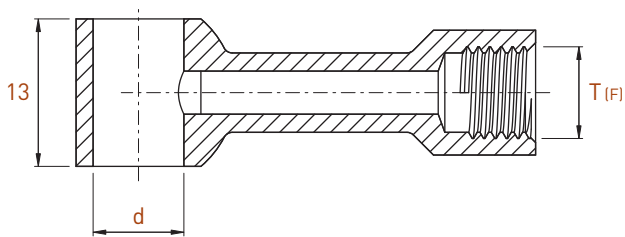
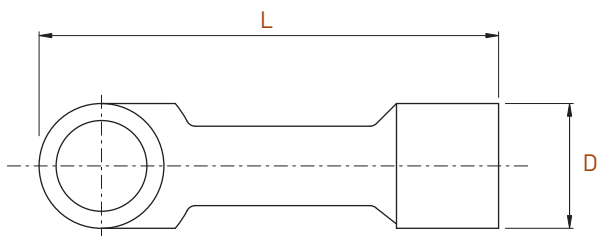

T (F)	A	L	d	D	Art. N°
M6	10	31.5	6	9	JABF-Ø6-M6
M8X1	13	40.5	8	11	JABF-Ø8-M8X1
M8X1	13	42.5	10	11	JABF-Ø10-M8X1
BSP1/8	13	42.5	10	13	JABF-Ø10-BSP1/8

- Banjos longs coudés femelle**
- Adapter lang 45° Innengewinde**
- Long curved female banjos**

JABF-45°

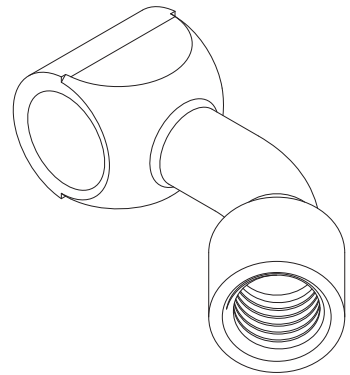
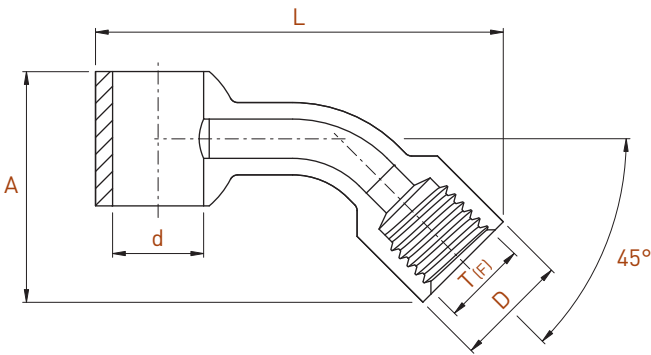
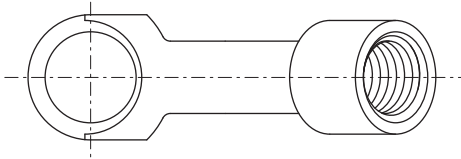

T (F)	A	L	d	D	Art. N°
M6	10	33	6	9	JABF-Ø6-M6-45°
M8X1	11.8	40	8	11	JABF-Ø8-M8X1-45°
	13	40.5	10	11	JABF-Ø10-M8X1-45°

Vis banjo

Hohlschrauben

Banjo screws

JEB

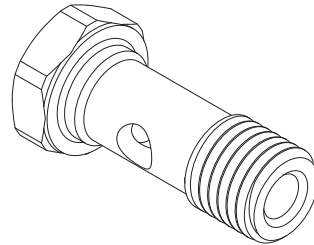
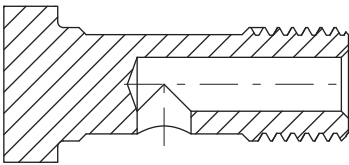
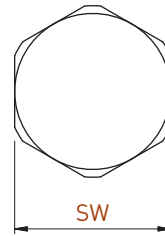
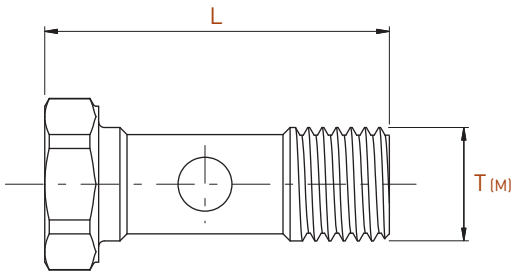

T (M)	L	SW	Art. N°
M5	18.3	8	JEB-M5-L18
M6	18.8	8	JEB-M6-L19
M8X1	24.3	11	JEB-M8X1-L24
BSP1/8	26	13	JEB-BSP1/8-L26

Vis banjo double

Hohlschrauben doppelt

Double banjo screws

JEB-DUO

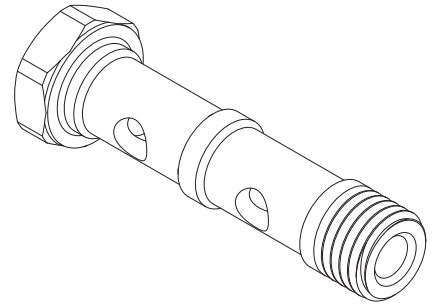
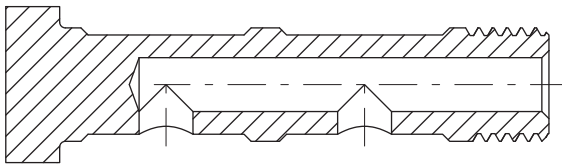
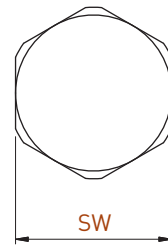
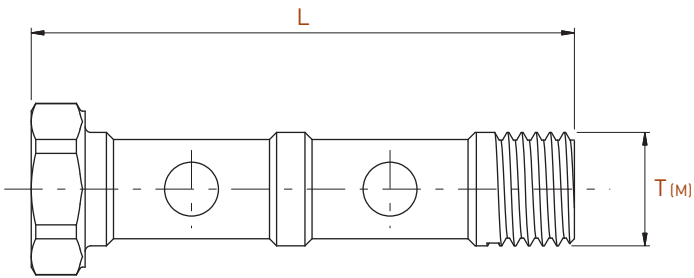

T (M)	L	SW	Art. N°
M6	29.8	8	JEB-M6-L30-DUO
M8X1	38.3	11	JEB-M8X1-L38-DUO
BSP1/8	40	13	JEB-BSP1/8-L40-DUO

JET-LINE

Fiches de verrouillage

Verschlussstecker

Sealing connecting plugs

JVB

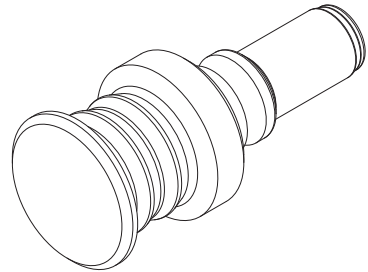
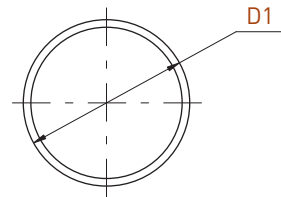
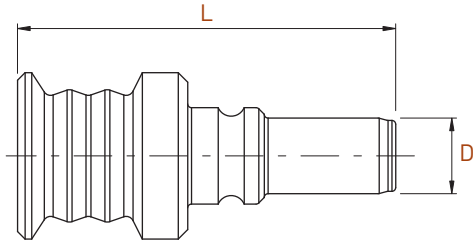

D	D1	L	Art. N°
4	8.8	20	JVB-D4
6	12	27	JVB-D6

Fiches de connexion

Innengewindestecker

Connecting plugs

JVF

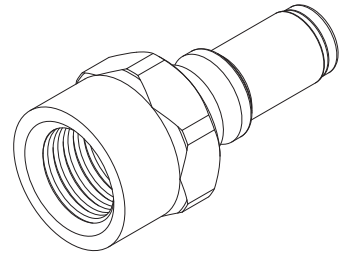
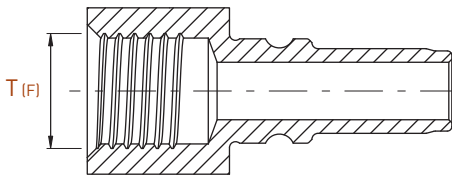
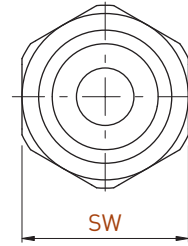
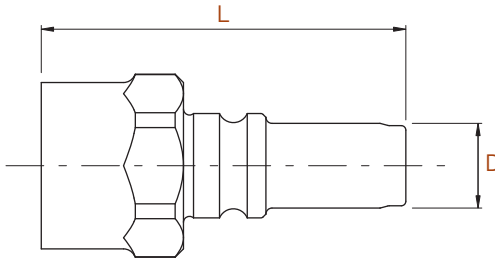

D	T (F)	L	SW	Art. N°
4	M6	18.3	8	JVF-M6-D4
6	M8X1	24	11	JVF-M8X1-D6
6	BSP1/8	25.5	11	JVF-BSP1/8-D6

JET-LINE

- Fiches de connexion fixes femelle
- Innengewindestecker mit Verdrehsicherung
- Female positioning connection plugs

JWF

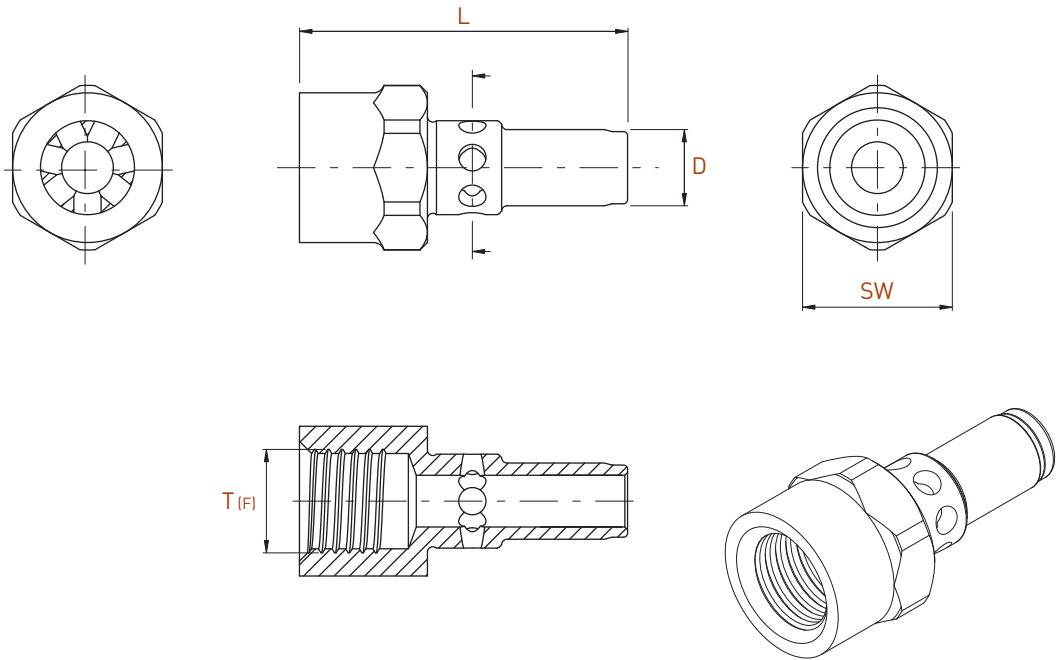

D	T (F)	L	SW	Art. N°
4	M6	18.3	8	JWF-M6-D4
6	M8X1	24	11	JWF-M8X1-D6

Fiches de connexion fixes mâle

Aussengewindestecker mit Verdrehsicherung

Male positioning connection plugs

JWM

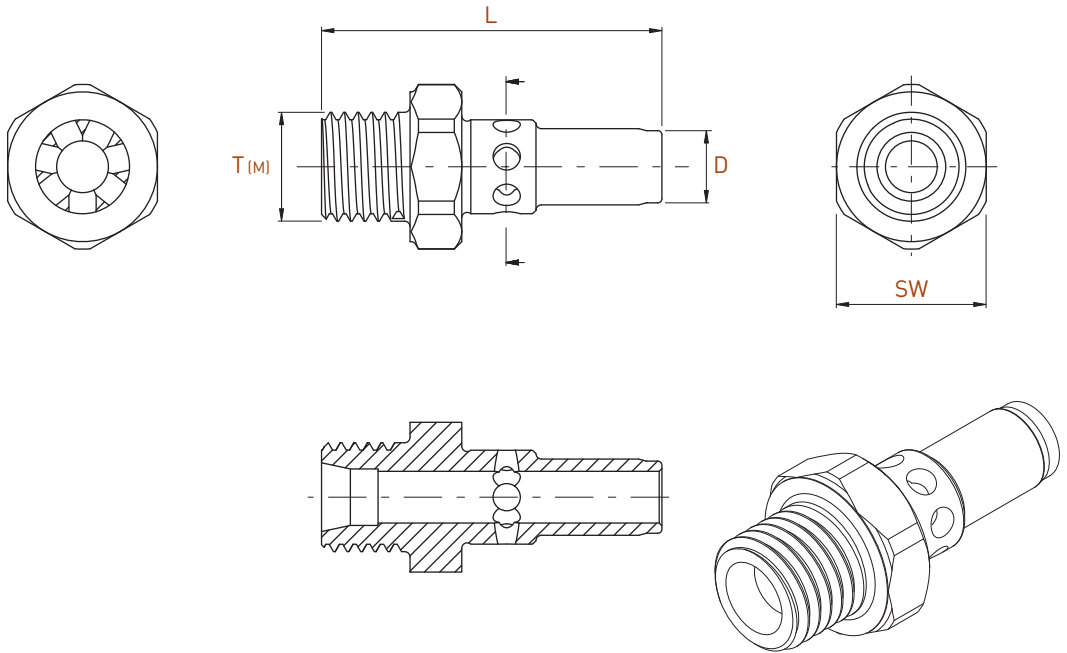

D	T (M)	L	SW	Art. N°
4	M6	18.3	8	JWM-M6-D4
6	M8X1	25	11	JWM-M8X1-D6

JET-LINE

Blocs de distribution

Kühlmittelverteiler

Distribution blocks

JK

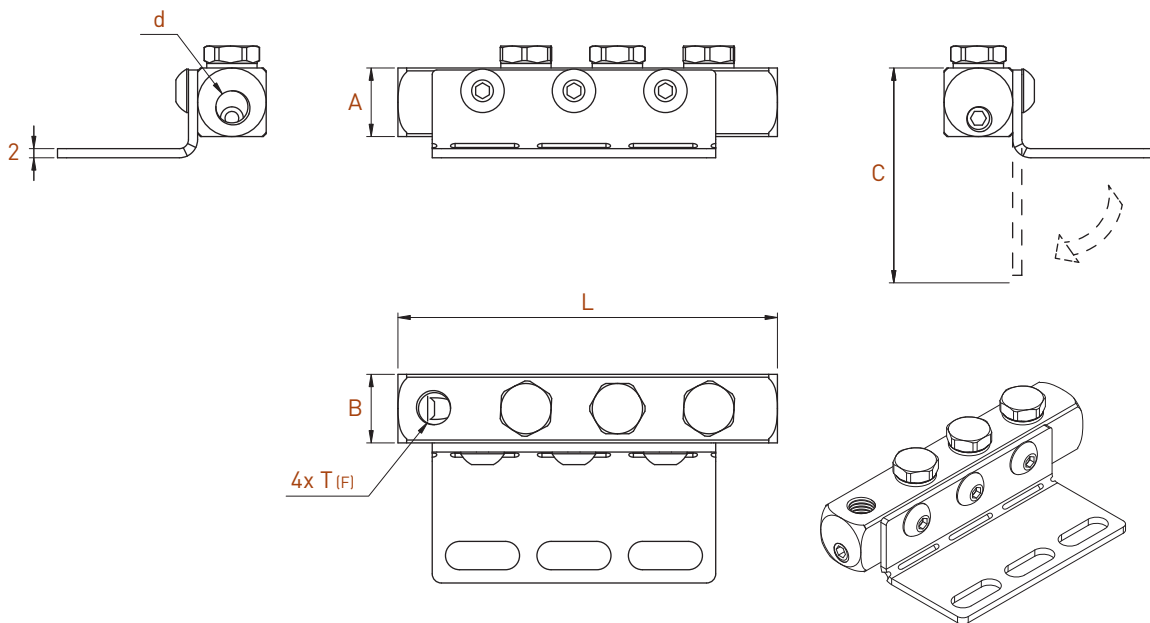

T (F)	A	B	C	d	L	Art. N°
M5	10	10	37	M5	62	JK-M5-1010-4T
M6	10	10	37	M6	62	JK-M6-1010-4T
M8X1	15	15	47	M8X1	83	JK-M8X1-1515-4T
BSP1/8	15	15	47	BSP1/8	83	JK-BSP1/8-1515-4T

Qty	Livré avec	Mitgeliefert	Supplied with
1	Plaque de serrage pliable	Faltbare Klemmplatte	Foldable clamping plate
3	Vis bombée	Linsenkopfschraube	Domed clamping Screw
3	Vis sans tête bouchon	Verschlußstopfen	Sealing screw
3	Joint d'étanchéité en cuivre	Kupferdichtungsringe	Copper sealing basket
1	Vis sans tête bouchon	Madenschraube	Grub screw

Bouchons d'étanchéité

Verschlußstopfen

Sealing plugs

JBB

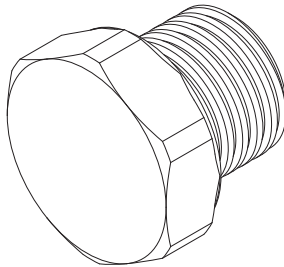
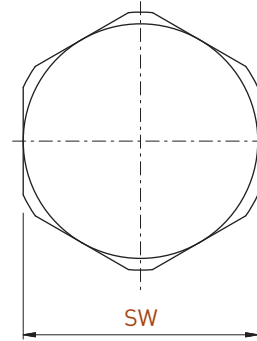
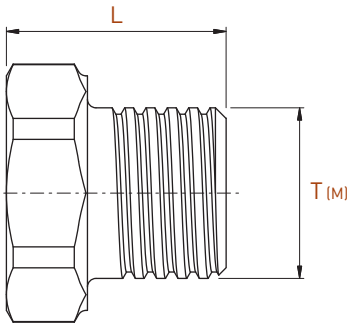

SW	T (M)	L	Art. N°
8	M5	7.3	JBB-M5-L7.0
8	M6	7.8	JBB-M6-L8.0
11	M8X1	10.3	JBB-M8X1-L10.0
11	BSP1/8	10.3	JBB-BSP1/8-L10.0

JET-LINE

Kit articulé avec buse d'arrosage

Gelenkkit mit Kühlungsdüse

Articulated kit with coolant nozzle

JKIT-AR3

new

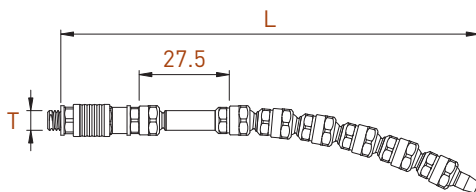
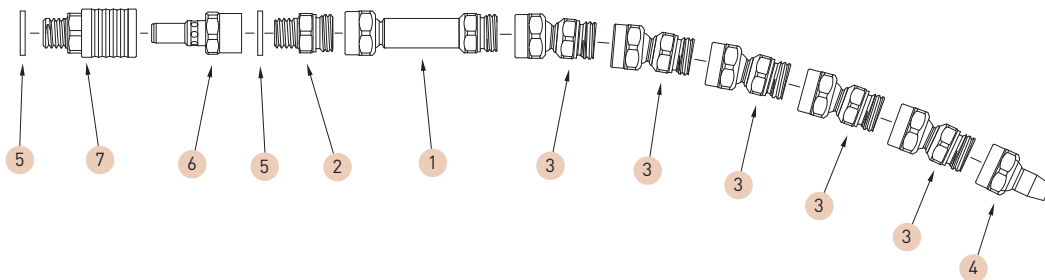

Ref	Qty	Kit composition
1	1	JAR3-L27.5
2	1	JRMM-AR3-M6-L3.0
3	5	JAR3-L12.5
4	1	JJ-AR3-D3-L9
5	2	JO-M6
6	1	JWF-M6-D4
7	1	JS-M6-D4

T (M)	L	Art. N°
M6	130	JKIT-AR3-M6-D3-130

Pression max	Couple de serrage Anzugsmoment Torque setting
150 bar (2.175psi)	1.8 Nm

Option recommandée Empfohlene Option Recommended option	Page Seite Page
C-AR3 	16.45

Kit articulé avec buse d'arrosage
Gelenkkit mit Kühlungsdüse
Articulated kit with coolant nozzle

JKIT-AR6

new

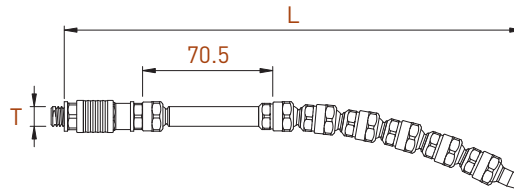
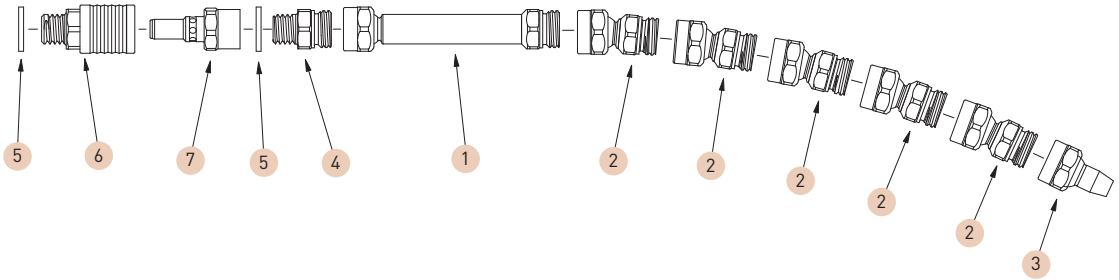

Ref	Qty	Kit composition
1	1	JAR6-L70.5
2	5	JAR6-L20.5
3	1	JJ-AR6-D6-L16
4	1	JRMM-AR6-M8X1-L4
5	2	JO-M8X1
6	1	JS-M8X1-D6
7	1	JWF-M8X1-D6

T (M)	L	Art. N°
M8X1	225	JKIT-AR6-M8X1-D6-225

Pression max	Couple de serrage Anzugsmoment Torque setting
100 bar (1.450 psi)	6 Nm

Option recommandée Empfohlene Option Recommended option		Page Seite Page
C-AR6		16.45

JET-LINE

Kit tube en cuivre avec buse d'arrosage

Kit Kupferrohr mit Kühlungsdüse

Kit copper tube with coolant nozzle

JKIT-CU

new

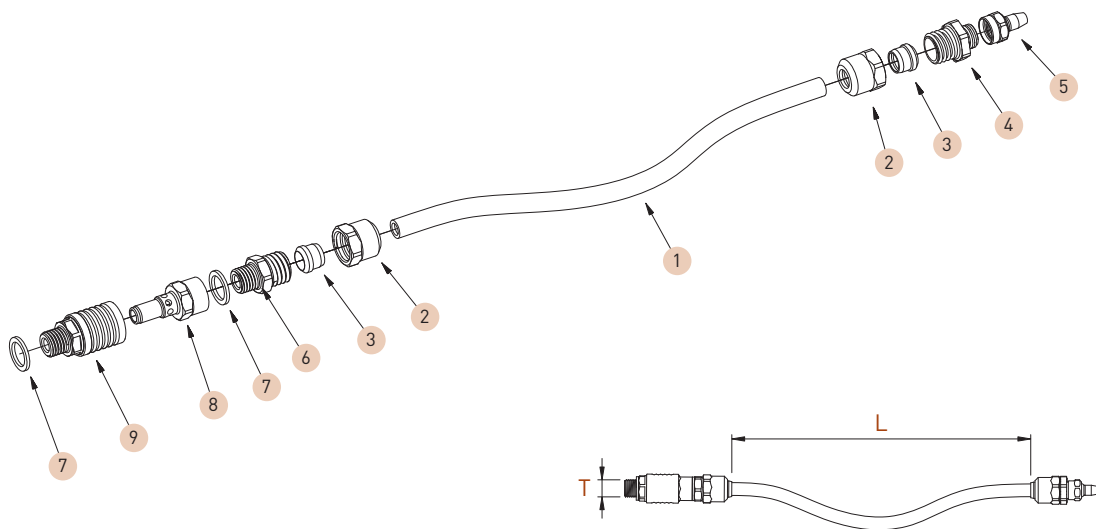

Ref	Qty	Kit composition
1	1	JT-CU
2	2	JN-M10-D6
3	2	JNG-D6
4	1	JRMM-AR3-M10-L3.0
5	1	JJ-AR3-D3-L9
6	1	JRMM-M10-M8X1-L3.5
7	2	JO-M8X1-D6
8	1	JWF-M8X1-D6
9	1	JS-M8X1-D6

T (M)	L	Art. N°
M8X1	305	JKIT-CU-AR3-D3-M8X1-305

Système articulé
 Gelenksystem
 Articulated system

JAR

new

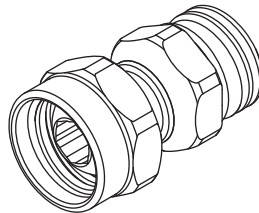
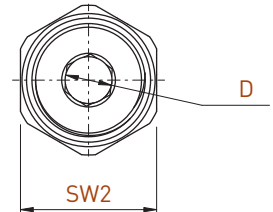
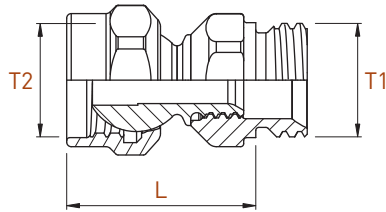
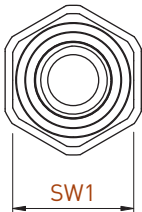

T1 (M)	T2 (F)	L	D	SW1	SW2	Art. N°
M7.5	M7.5	12.5	3	8	9	JAR3-L12.5
		27.5	3			JAR3-L27.5
		42.5	3			JAR3-L42.5
M13	M13	20.5	6	13	15	JAR6-L20.5
		45.5	6			JAR6-L45.5
		70.5	6			JAR6-L70.5

JET-LINE

Connecteurs mâle/mâle
Anschlüsse Aussengewinde
Male connectors

JRMM-AR

new

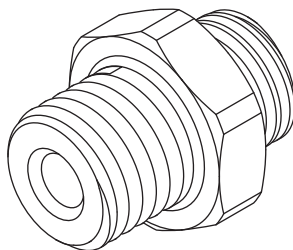
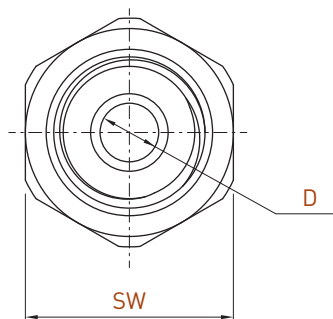
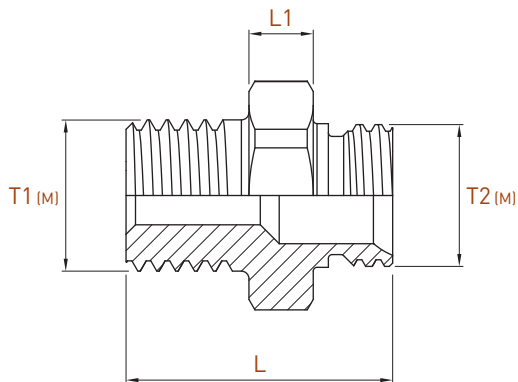

T1 (M)	T2 (M)	L	L1	D	SW	Art. N°
M6	M7.5	12	3	3	8	JRMM-AR3-M6-L3.0
M8X1	M7.5	14	3.5	3	11	JRMM-AR3-M8X1-L3.5
M10	M7.5	15	3	3	11	JRMM-AR3-M10-L3.0
M8X1	M13	4	17	6	13	JRMM-AR6-M8X1-L4.0
M10X1	M13	4	18	6	13	JRMM-AR6-M10X1-L4.0
BSP 1/8"	M13	4	18	6	13	JRMM-AR6-BSP1/8-L4.0

Buses

Düse

Nozzle

JJ-AR

new

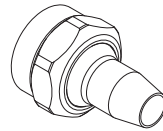
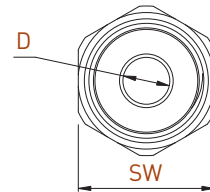
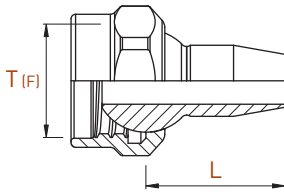

T (F)	L	D	SW	Art. N°
M7.5	9	3	9	JJ-AR3-D3-L9
M13	16	6	15	JJ-AR6-D6-L16

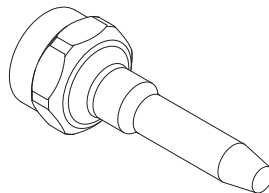
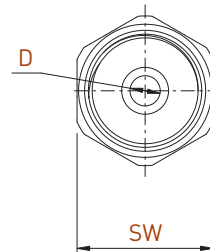
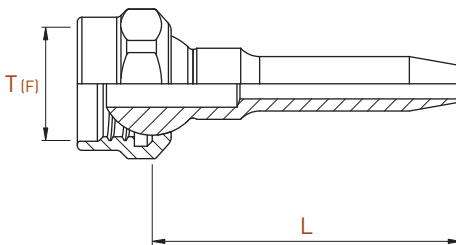

T (F)	L	D	SW	Art. N°
M7.5	20	2	9	JJ-AR3-D2-L20
M13	35	3	15	JJ-AR6-D3-L35

JET-LINE

Buses

Düse

Nozzle

JJ-AR

new

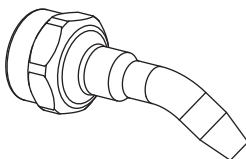
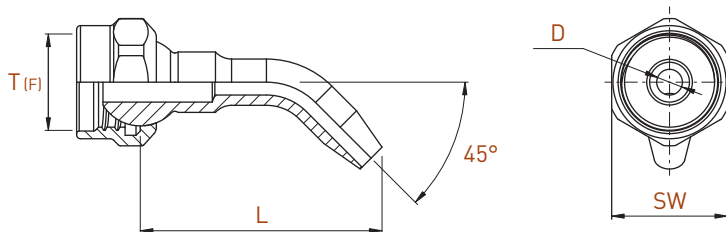

T (F)	L	D	SW	Art. N°
M7.5	19	2	9	JJ-AR3-D2-L19-45°
M13	23,5	6	15	JJ-AR6-D6-L23.5-45°

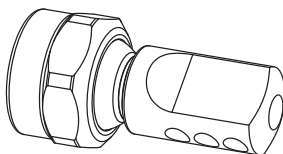
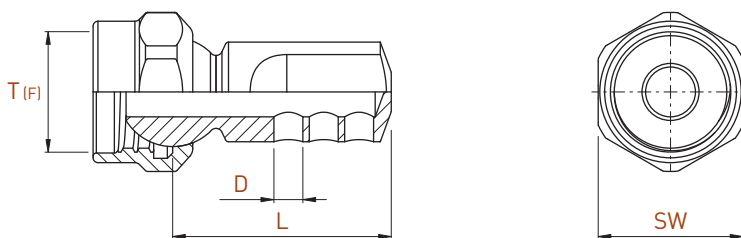

T (F)	L	D	SW	Art. N°
M7.5	15	1.8	9	JJ-AR3-3XD1.8-L13.5
M13	24	3.4	15	JJ-AR6-3XD3.4-L24

Appareil de cintrage

Biegegerät

Bending tool

JTB

new

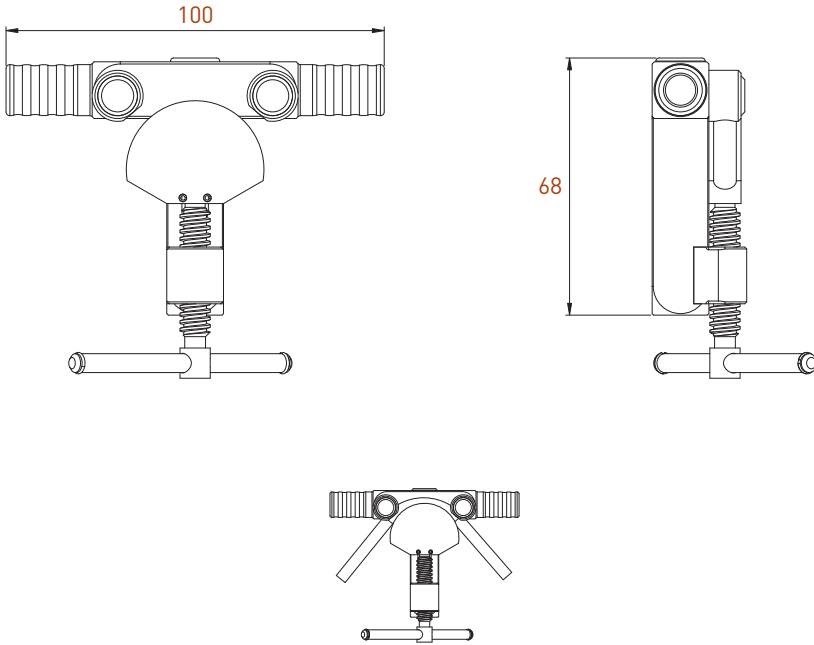

Art. N°

JTB-D6

- Clés de serrage
- Gabelschlüssel
- Clamping keys

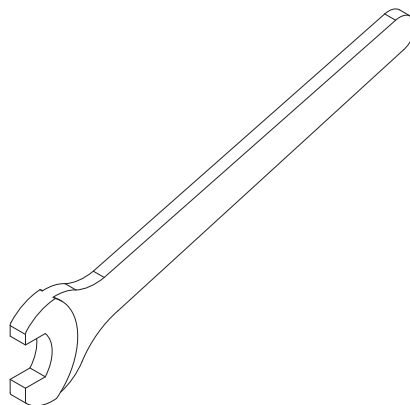
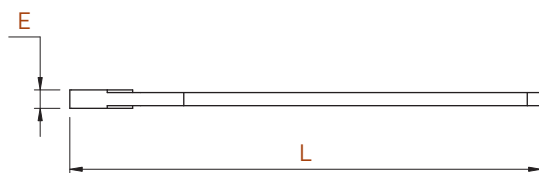
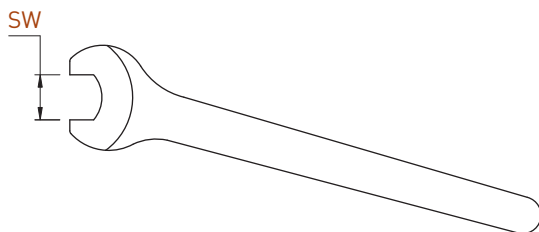

SW	E	L	Art. N°
8	2.5	90	C-SW8-E2.5
11	3.7	110	C-SW11-E3.7
13	5.8	130	C-SW13-E5.8
8	2.5	55	C-AR3 new
9	3		
13	3	65	C-AR6 new
15	4		

INDEX

Répertoire des articles

Artikelverzeichnis

Index of items

	Art. N°	Page
10	1010	13.111
11	1101	15.04
	1102	15.06
	1103	15.08
	1104	15.10
	1106	15.12
	1107	13.19
12	1200	13.14
14	1400-J	13.02
	1401-K	13.03
	1402	13.18
	1420	13.04
	1460	13.05
15	1500	13.15
	1510	13.15
16	1600	13.16
	1610	13.17
	1680	14.108
18	1820	15.17
19	1901	13.97
20	2010	14.112
	2011	14.113
	2012	14.113
	2013	14.114
	2014	14.114
	2020	14.115
	2023	14.117
	2026	14.120
	2030	14.122
22	2200	13.14
24	2400-J	13.02
	2401-K	13.03
	2402	13.18
	2405	13.08
	2420	13.04
	2425	13.09
	2435	13.12
	2436	13.13
	2440	13.10
	2441	13.10
	2450	13.07
	2450-SP	13.06
	2460	13.07
	2470	13.06
25	250	4.04
	251	4.08
	251-E	4.17
	252	4.10
	2520	13.15
	253	4.12
	2530	13.15
	254	4.14
	256	4.16
26	260	4.04
	261	4.08
	261-E	4.17
	262	4.10
	2620	13.16
	263	4.12
	2630	13.17

	Art. N°	Page
	264	4.14
	266	4.16
	2680	14.107
	2690	14.110
28	2810	15.16
	2811	15.16
	2815	15.16
	2820	15.17
31	310	6.06
	3123	14.58
	317	6.08
	3170	14.07
	318	6.08
	319	6.09
32	320	6.06
	3230	14.63
	3231	14.66
	3238	14.89
	3239T	14.67
	327	6.08
	3270S	14.18
	3271	14.11
	3278	14.44
	3279T	14.21
	328	6.08
	329	6.09
	32xxMV	13.60
33	330	6.10
	3330	14.69
	3331	14.72
	3336-HA	14.73
	3337-HA	14.73
	3338	14.90
	3341	14.74
	3345-S	14.75
	3361	14.76
	337	6.12
	3370S	14.33
	3371	13.24
	3375	14.30
	3379T	14.36
	338	6.12
	3383	14.93
	339	6.13
34	340	6.10
	3430	14.78
	3431	14.79
	3439T	14.84
	3441	14.80
	3445-S	14.81
	3450	14.85
	347	6.12
	3471	14.39
	3472	14.42
	348	6.12
	349	6.13
35	3545	14.86
	35645	14.87
36	3611	14.95
38	3810	14.88

Répertoire des articles

Artikelverzeichnis

Index of items

	Art. N°	Page
	383x	14.94
39	3901	14.97
	3911	14.96
63	630	3.06
	631-EP	3.30
	632	3.08
	633	3.12
	634	3.21
	635	3.24
	636	3.26
	637	3.28
64	640	3.06
	641-EP	3.30
	642	3.08
	643	3.12
	644	3.20
	645	3.24
	646	3.26
	647	3.28
65	650	3.31
	651	3.34
	651-EP	3.44
	660	3.31
	661	3.34
	661-EP	3.44
70	701S3371	14.91
	7050	1.143
	7051	1.144
	7051-E	1.148
	7060	1.143
	7061	1.144
	7061-E	1.148
71	710	1.10/2.06
	711	1.16
	711-EP	1.23
	711-ESF	2.09
	711SF	2.08
	712	1.17
	712SF	2.08
	713	1.18
	713SF	2.09
	714	1.21
	716	1.22
72	720	1.14
	721	1.16
	721-EP	1.23
	722	1.17
	723	1.18
	724	1.21
	726	1.22
73	730	1.26/2.10
	730R-DECO10	1.157
	730-DECO10	1.159
	730-NOVIBRA	1.30/2.11
	730RC	1.29/2.20
	730R-MULTISWISS	1.163
72	731	1.32
	731-E	1.67
	731-ESF	2.19
	731RSF	2.21

	Art. N°	Page
	732	1.46
	733	1.49
	734	1.56
	735	1.61
	736	1.63
	736SF	2.17
74	740	1.26/2.10
	740-DECO10	1.157
	740L-DECO10	1.159
	740-SF	2.11
	740Z	1.156
	741	1.32
	741-E	1.67
	741-ESF	2.19
	741SF	2.13
	742	1.46
	742SF	2.13
	743	1.49
	743SF	2.15
	744	1.56
	745	1.61
	746	1.63
	746SF	2.17
	748SF	2.18
	749SF	2.18
75	750	1.70
	750RAS	1.164
	750RC	1.72/2.20
	750R-DECO10	1.158
	750R-MULTISWISS	1.163
	751	1.78
	751-E	1.131
	751RDSF	2.21
	752	1.100
	753	1.106
	754	1.117
	756	1.125
	757	1.129
76	760	1.70
	760L-DECO10	1.160
	760Z	1.156
	761	1.78
	761-E	1.131
	762	1.100
	763	1.106
	764	1.117
	766	1.125
	767	1.129
77	770	1.133
	770R-DECO	1.161
	770-SN-SF	2.22
	771	1.136
	771-E	1.142
	771R	1.138
	771RVSF	2.24
78	780	1.133
	781	1.136
	781-E	1.142
A	A-SC...	7.17
	A-SD...	7.33

INDEX

Répertoire des articles

Artikelverzeichnis

Index of items

	Art. N°	Page
	A-SV...	7.51
B	BA	10.20
	BAX	10.22
	BCX	10.24
	B-E	10.42
	BH-D	10.10
	BHKN	10.16
	BH-MASTER	10.44
	BHS	10.18
	BHS-D	10.12
	BHY-D	10.14
	BWD1	10.45
C	C45	10.26
	C45X	10.28
	CCGT	7.19
	CCMT	7.23
	CERMET CC...	7.25
	CERMET DC...	7.43
	CERMET VC...	7.60
	CUT-GN	9.21
	CUT-H	9.10
	CUT-HX	9.11
	CUT-HZ	9.12
	CUT-HZ-JET	9.13
	CUT-PN	9.16
	CUT-PNW	9.18
	CUT-PR	9.17
	CUT-PRW	9.19
	CUT-TN	9.20
	CUT-UL	9.15
	CUT-UN	9.14
	CUT-UR	9.15
D	DCGT	7.37
	DCMT	7.41
	DHP3336	14.77
	DHP3371	14.31
	DHP3436	14.83
	DHP3471	14.41
	DT	1.165
E	E100-P	14.100
	E300-P	14.101
	E300-R	14.102
	E900-P	14.103
	E-DHP	14.57
	E-SC...	7.18
	E-SD...	7.34
	ET UL	8.21
	ET-AN	8.26
	ET-AR	8.27
	ET-H	8.06
	ET-H-JET	8.07
	ET-HK	8.16
	ET-HK-RS	8.17
	ET-HM	8.14
	ET-HM-JET	8.15
	ET-HUK	8.18
	ET-JN	8.22
	ET-JR	8.23
	ET-TN	8.24
	ET-TR	8.25

	Art. N°	Page
	ET-UN	8.20
	ET-UR	8.21
F	FEG	10.41
	FIG	10.40
G	GTX	10.32
	GWS02R-HM	8.09
	GWS202L-HM	8.12
	GWS41L-HM	8.10
	GWS41R-HM	8.11
	GX	10.30
H	H-HM-JET	8.08
	HSK	1.155
	HSK-LW	11.21
J	JABF	16.26
	JABF-45°	16.28
	JAR	16.39
	JBB	16.35
	JCBF	16.24
	JCBM	16.25
	JEB-DUO	16.29
	JJ-AR	16.41
	JK	16.34
	JKIT	16.04
	JKIT-AR	16.36
	JKIT-CU	16.38
	JN	16.22
	JNG	16.23
	JO	16.15
	JRFF	16.20
	JRMF	16.18
	JRMM	16.21
	JRMM-AR	16.40
	JS	16.14
	JT-CU	16.17
	JTX-AC	16.16
	JVB	16.30
	JVF	16.31
	JWF	16.32
	JWM	16.33
L	LW-3_0-JET	11.09
	LW-7_0-JET	11.06
	LW-D	11.19
	LW-E	11.20
	LW-JET	11.05
	LW-SC_-JET	11.12
	LW-SD_-JET	11.14
	LW-SV_-JET	11.17
M	ML12A	12.64
	ML12-B074-1-6T	12.55
	ML12-B075-1-8T	12.56
	ML12-CITIZEN-C16	12.06
	ML12-CITIZEN-L12-1M7	12.07
	ML12-CITIZEN-L12-2M10	12.08
	ML12-CITIZEN-M16V/VIII	12.09
	ML12-CITIZEN-R04-QTF3101-3T	12.12
	ML12-CITIZEN-R04-QTF5008-4T	12.10
	ML12-CITIZEN-R04-QTF5108-4T	12.10
	ML12-CITIZEN-R07-QTF4008-5T	12.13
	ML12-CITIZEN-R07-QTF4108-6T	12.13
	ML12-CITIZEN-R07-QTF4208-3T	12.14

Répertoire des articles

Artikelverzeichnis

Index of items

Art. N°	Page
ML12-CITIZEN-R07-QTF4608-4T	12.14
ML12-CT20-2020019-7T	12.43
ML12-D10-3T	12.21
ML12-DECO10-DUO	12.37
ML12-DECO10-JET	12.37
ML12-DT12-2020206-9T	12.42
ML12F	12.64
ML12-GT13-390223-7T	12.44
ML12-GT13-390224-5T	12.44
ML12-HANWHA-XD20M	12.18
ML12-PO34-1-5T	12.57
ML12-PO34-1-7T	12.58
ML12-PO34-2-10T	12.58
ML12-PO34-2-4T	12.57
ML12-STAR-SB-12RG	12.22
ML12-STAR-SR-10J	12.23
ML12-STAR-SW-12-R11-2T	12.24
ML12-STAR-SW-12-R11-8T	12.24
ML12-SWISS-NANO-2T	12.40
ML12-SWISS-NANO-3T	12.40
ML12-SWISS-NANO-6T	12.38
ML12-SWISS-NANO-7-4T	12.41
ML16A	12.64
ML16-CITIZEN-K16	12.15
ML16-CITIZEN-L20	12.16
ML16-CITIZEN-L20E	12.17
ML16-DECO13-DUO	12.50
ML16-DECO13-JET	12.50
ML16-DECO20-DUO	12.51
ML16-DECO20-JET	12.51
ML16-DT26-2020206-7T	12.54
ML16F	12.64
ML16-GT26-386209-6T	12.46
ML16-GT26-386210-5T	12.46
ML16-GT32-386209-5T	12.48
ML16-GT32-386210-4T	12.48
ML16-HANWHA-SL12/16	12.19
ML16-KMX26-DUO	12.20
ML16-KMX26-JET	12.20
ML16-S20-DUO	12.52
ML16-S20-JET	12.52
ML16-STAR-SA-16	12.25
ML16-STAR-SB-16	12.26
ML16-STAR-SB-16/20RG	12.27
ML16-STAR-SB20C/E	12.28
ML16-STAR-SR20J	12.30
ML16-STAR-SR20J11-A/B	12.31
ML16-STAR-SR-20R	12.29
ML16-STAR-SR-20R111	12.30
ML16-STAR-SR-20R1V-2T	12.32
ML16-STAR-SR-20R1V-6T	12.32
ML16-STAR-SR-32J	12.33
ML16-STAR-SV-12/20	12.34
ML16-STAR-SV-20R	12.35
ML16-STAR-SW-20R-2T	12.36
ML16-STAR-SW-20R-6T	12.36
ML16-SWISS-ST26-DUO	12.53
ML16-SWISS-ST26-JET	12.53
ML-AD	12.85
ML-FIX	12.82

Art. N°	Page
ML-JET	12.82
MS-HM	8.13
P POLYGONAL INTERFACE	1.153
S SC...	7.13
SD...	7.27
STARTER-KIT	16.12
SV...	7.45
T T216-L	5.04
T216L-EP	5.09
T216L-FT	5.06
T216L-GT	5.07
T216L-GTX	5.08
T216L-GX	5.05
T216-R	5.04
T216R-EP	5.09
T216R-FT	5.06
T216R-GT	5.07
T216R-GTX	5.08
T216R-GX	5.05
TM	10.38
TP55	10.36
TP60	10.34
V VCGT	7.52
VCGW	7.53
VGMT	7.58
W W750	1.149
W751-E	1.151
W760	1.149
W761-E	1.151



PERFORMANCE | PRECISION | RIGIDITY

SWISSMADE

**APPLITEC MOUTIER SA
RUE INDUSTRIELLE 95
2740 MOUTIER
CH-SWITZERLAND**

**+41 (0)32 494 60 20
INFO@APPLITEC-TOOLS.COM**

WWW.APPLITEC-TOOLS.COM