

Index

Codification des outils ISO-Line
ISO-Line Bezeichnungssystem
ISO-Line designation system

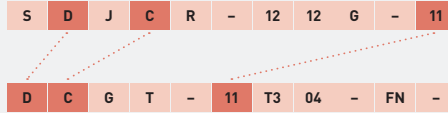

> 7.02

Géométries de coupe
Spanformgeometrien
Cutting geometries



> 7.05

Nuances
Sorten
Grades



> 7.11

Porte-outils
et plaquettes 80°
Halter und
WSP 80°
Holders and
inserts 80°

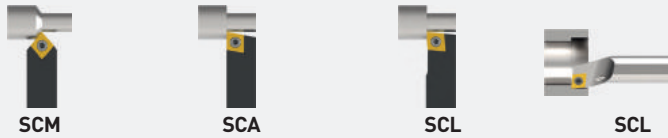

> 7.13

Porte-outils
et plaquettes 55°
Halter und
WSP 55°
Holders and
inserts 55°

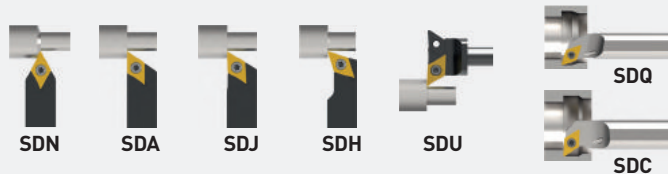

> 7.27

Porte-outils
et plaquettes 35°
Halter und
WSP 35°
Holders and
inserts 35°



> 7.45

Pièces de rechange et accessoires
Ersatzteile und Zubehör
Spare parts and accessories



> 7.61

Paramètres de coupe
Schnittwerte
Machining data

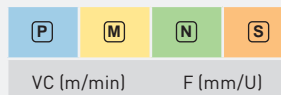

> 7.62

ISO-LINE

Codification des porte-outils ISO-Line

ISO-Line Bezeichnungssystem für Halter

ISO-Line designation system for holders

Méthode de serrage Klemmsystem Clamping system	Forme de la plaquette Plattenform Insert shape	Géométrie du porte-outil Halteform Holder geometry	Angle de dépointe de la plaquette WSP-Freiwinkel Insert clearance angle	Direction de coupe Schneidrichtung Cut direction		Hauteur du porte-outil Halter Höhe Holder height	Largeur du porte-outil Halter-Breite Holder width	Longueur du porte-outil Halter-Länge Holder length		Dimension de la plaquette (L) WSP-Größe (L) Insert size (L)
--	--	--	---	--	--	--	---	--	--	---

S D J C R - 12 12 G - 11

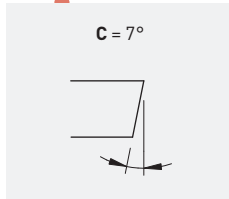
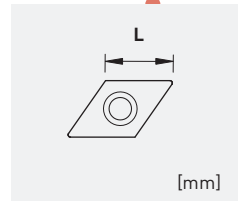
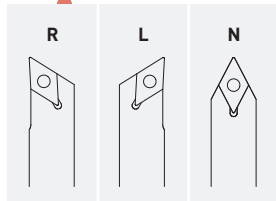

A x B (or Ø) [mm]

- 08 x 08
- 10 x 10
- 12 x 12
- 12.7 x 12.7 (1/2 in)
- 16 x 16
- 20 x 20
- Ø: D10 / D20 / D25.4 (Ø1 in)

Length: [mm]

- F = 75
- G = 90
- J = 110
- X = Special

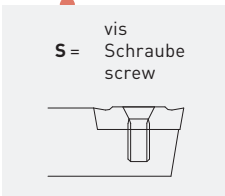
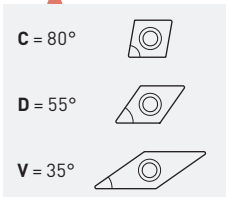
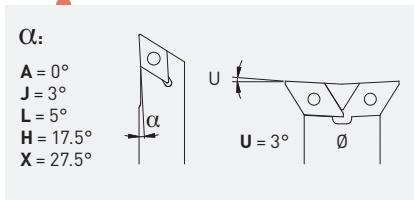

Compatibilité porte-outil - plaquette
WSP - Halter Kompatibilität
Holder - insert compatibility

S	D	J	C	R	-	12	12	G	-	11
D	C	G	T	-	11	T3	04	-	FN	-

Codification des porte-outils ISO-Line
ISO-Line Bezeichnungssystem für Halter
ISO-Line designation system for holders

Méthode de serrage Klemmsystem Clamping system	Largeur du porte-outil Halter-Breite Holder width	Longueur du porte-outil Halter-Länge Holder length		Méthode de serrage Klemmsystem Clamping system	Forme de la plaquette Plattenform Insert shape	Géométrie du porte-outil Halterform Holder geometry	Angle de dépointe de la plaquette WSP-Freiwinkel Insert clearance angle	Direction de coupe Schneidrichtung Cut direction		Dimension de la plaquette (L) WSP Grösse (L) Insert size (L)
A	12	K	-	S	C	L	C	R	-	06

**Longueur
Länge
Length**
 F = 80
 H = 100
 J = 110
 K = 125
 M = 150
 Q = 180

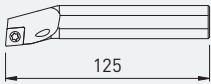

**Ø queue
Schaft Ø
Shank Ø**

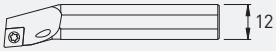
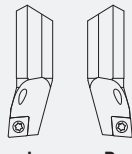



L **R**

C = 7°



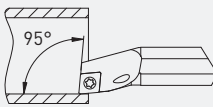

L = 95°
Q = 107.5°
U = 93°



A = acier avec lubrification
Stahl mit Kühlung
Steel with coolant

E = carbure avec lubrification
Hartmetall mit Kühlung
Carbide with coolant

C = 80° 

D = 55° 

V = 35° 

vis
S = Schraube
screw

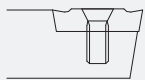
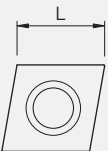
ISO-LINE

Codification des plaquettes ISO-Line

ISO-Line Bezeichnungssystem für WSP

ISO-Line designation system for inserts

Forme de la plaquette Plattenform Insert shape	Angle de dépointe de la plaquette WSP-Freiwinkel Insert clearance angle	Classe de tolérance Toleranz Klasse Tolerance class	Brise-copeau Spanbrecher Chip breaker		Dimension de la plaquette (L) WSP Größe (L) Insert size (L)	Épaisseur de la plaquette (E) WSP Dicke (E) Insert thickness (E)	Rayon de pointe de la plaquette WSP Eckenradius Insert corner radius		Exécution d'arête et direction de coupe Schneidkante Ausführung und Schneidrichtung Edge type and cutting direction		Géométrie de coupe Spanformgeometrie Cutting geometry														
D	C	G	T	-	11	T3	04	-	FN	-	X8														
		 G = ±0.025 mm M = ±0.05 mm			 L	 E	 R: 003 = 0.03 mm 005 = 0.05 mm 008 = 0.08 mm 01 = 0.1 mm 015 = 0.15 mm 02 = 0.2 mm 04 = 0.4 mm 08 = 0.8 mm																		
	 C = 7°				 L Ø d [mm]																				
	 C = 80°				<table border="1"><thead><tr><th>L</th><th>Ø d [mm]</th></tr></thead><tbody><tr><td>CC...06</td><td></td></tr><tr><td>DC...07</td><td>6.350</td></tr><tr><td>VC... 11</td><td></td></tr><tr><td>VC... 13</td><td>7.940</td></tr><tr><td>CC...09</td><td></td></tr><tr><td>DC... 11</td><td>9.525</td></tr><tr><td>VC... 16</td><td></td></tr></tbody></table>	L	Ø d [mm]	CC... 06		DC... 07	6.350	VC... 11		VC... 13	7.940	CC... 09		DC... 11	9.525	VC... 16					
L	Ø d [mm]																								
CC... 06																									
DC... 07	6.350																								
VC... 11																									
VC... 13	7.940																								
CC... 09																									
DC... 11	9.525																								
VC... 16																									
	 D = 55°																								
	 V = 35°																								

Géométries de coupe
Spanformgeometrien
Cutting geometries

G
tolerance class

Plaquettes en métal dur rectifiées
VHM geschliffene WSP
Carbide ground inserts

Finishing

FN-X8

Arête de coupe vive
Scharfe Schneidkante
Sharp edge

Poli
Poliert
Polished

P	★★★★★
M	★★★★
N	★★★
S	★★★

CCGT	DCGT	VCGT
p. 7.19	p. 7.37	p. 7.54

Semi-finishing

ENP-X8

Arête de coupe honée
Schneidkantenverrundung
Honed edge

Poli
Poliert
Polished

P	★★★★★
M	★★★
N	★★★
S	★★★

CCGT	DCGT	VCGT
p. 7.19	p. 7.37	p. 7.54

Finishing

FN-X17

Arête de coupe vive
Scharfe Schneidkante
Sharp edge

Poli
Poliert
Polished

P	★★★
M	★★★★★
N	★★★★★
S	★★★★★

CCGT	DCGT	VCGT
p. 7.20	p. 7.38	p. 7.55

Semi-finishing

ENP-X17

Arête de coupe honée
Schneidkantenverrundung
Honed edge

Poli
Poliert
Polished

P	★★★
M	★★★★★
N	★★★
S	★★★★★

CCGT	DCGT	VCGT
p. 7.20	p. 7.38	p. 7.55

ISO-LINE

Géométries de coupe
Spanformgeometrien
Cutting geometries

G
tolerance class

Plaquettes en métal dur rectifiées
VHM geschliffene WSP
Carbide ground inserts

FN-X25

Finishing



25°

Arête de coupe vive
Scharfe Schneidkante
Sharp edge

Poli
Poliert
Polished

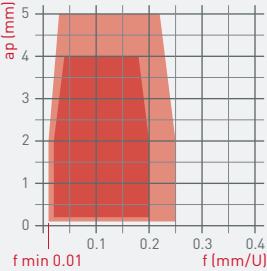

ap (mm)

f (mm/U)

f min 0.01

P	
M	★★★
N	★★★★★
S	★★★★★

CCGT DCGT VCGT



p. 7.21 p. 7.39 p. 7.56

ENP-X25

Semi-finishing



25°

Arête de coupe honée
Schneidkantenverrundung
Honed edge

Poli
Poliert
Polished

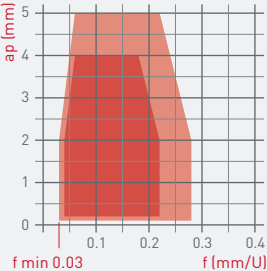

ap (mm)

f (mm/U)

f min 0.03

P	
M	★★★
N	★★★★★
S	★★★★★

CCGT DCGT VCGT



p. 7.21 p. 7.39 p. 7.56

ENP-X20

Semi-finishing



20°

Arête de coupe honée
Schneidkantenverrundung
Honed edge

Poli
Poliert
Polished

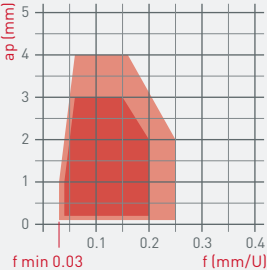

ap (mm)

f (mm/U)

f min 0.03

P	
M	★★★★★
N	★★★
S	★★★★★

CCGT DCGT VCGT



p. 7.22 p. 7.40 p. 7.57

Géométries de coupe
Spanformgeometrien
Cutting geometries



M
tolerance class

Plaquettes en métal dur
VHM-Wendepplatten
Carbide inserts

EN-XF3

Semi-finishing

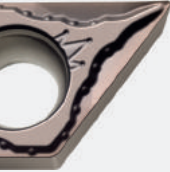
Finishing

12°

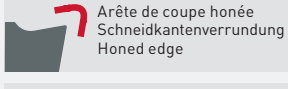

Arête de coupe honée
Schneidkantenverrundung
Honed edge

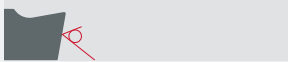
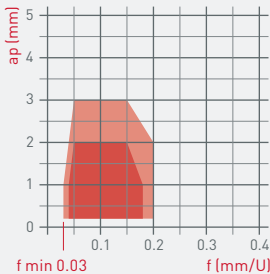

ap (mm)

f (mm/U)

f min 0.03

P	★★★★★
M	★★★★★
N	★★★
S	★★★

CCMT DCMT VCMT







p. 7.23 p. 7.41 p. 7.58

EN-XF2

Semi-finishing

Finishing

6°

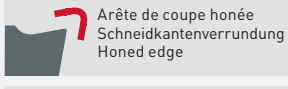

Arête de coupe honée
Schneidkantenverrundung
Honed edge

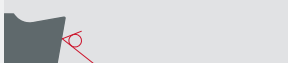
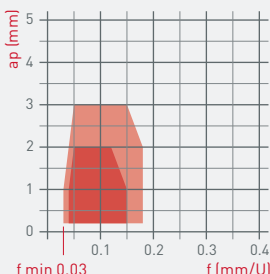

ap (mm)

f (mm/U)

f min 0.03

P	★★★★★
M	★★★
N	
S	★★★



CCMT DCMT VCMT

p. 7.23 p. 7.41 p. 7.58

EN-MF2

Semi-finishing

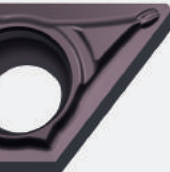
8°

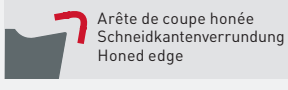

Arête de coupe honée
Schneidkantenverrundung
Honed edge

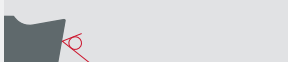
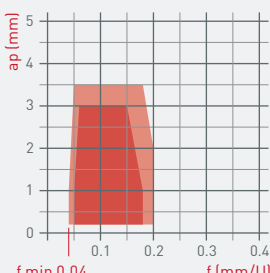

ap (mm)

f (mm/U)

f min 0.04

P	★★★★★
M	★★★★★
N	★★★
S	★★★

CCMT DCMT

p. 7.23 p. 7.41

ISO-LINE

Géométries de coupe
Spanformgeometrien
Cutting geometries

M
tolerance class

Plaquettes en métal dur
VHM-Wendeplatten
Carbide inserts

EN-MF

Semi-finishing

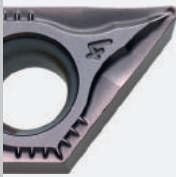

5°

Arête de coupe honée
Schneidkantenverrundung
Honed edge

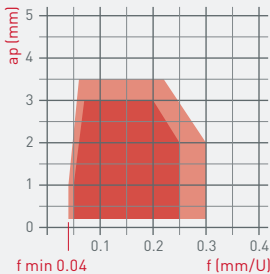

ap (mm)

f (mm/U)

f min 0.04

P	★★★★★
M	★★★
N	
S	

CCMT DCMT VCMT

p. 7.24 p. 7.42 p. 7.59

EN-HF3

Roughing

Semi-finishing

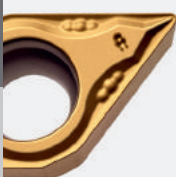

10°

Arête de coupe honée
Schneidkantenverrundung
Honed edge

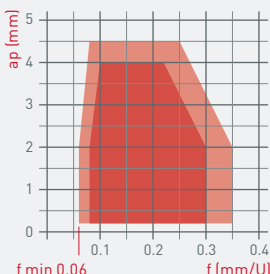

ap (mm)

f (mm/U)

f min 0.06

P	★★★★★
M	★★★★★
N	
S	★★★

CCMT DCMT

p. 7.24 p. 7.42

EN-HF

Roughing

Semi-finishing



12°

Arête de coupe honée
Schneidkantenverrundung
Honed edge

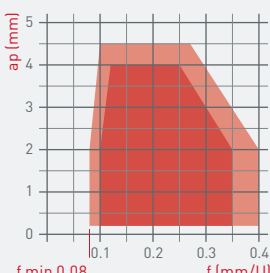

ap (mm)

f (mm/U)

f min 0.08

P	★★★★★
M	★★★★★
N	
S	

CCMT DCMT VCMT

p. 7.24 p. 7.42 p. 7.59

Géométries de coupe
Spanformgeometrien
Cutting geometries

G
tolerance class

Plaquettes en métal dur rectifiées
VHM geschliffene WSP
Carbide ground inserts

Super-finishing

FL/FR-X10



10°

Arête de coupe vive
Scharfe Schneidkante
Sharp edge

Poli
Poliert
Polished

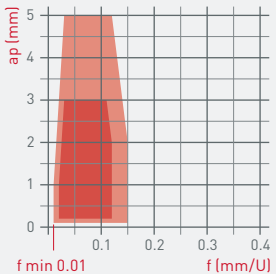

ap (mm)

f min 0.01 f (mm/U)

P	★★★★★
M	★★★★★
N	★★★★★
S	★★★★★

VCGT



p. 752

Finishing

Semi-finishing

ELP/ERP-X10



10°

Arête de coupe honée
Schneidkantenverrundung
Honed edge

Poli
Poliert
Polished

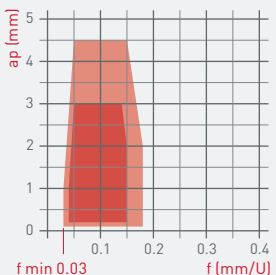

ap (mm)

f min 0.03 f (mm/U)

P	★★★★★
M	★★★★★
N	★★★
S	★★★

VCGT



p. 752

Finishing

Super-finishing

FN-K18



18°

Arête de coupe vive
Scharfe Schneidkante
Sharp edge

Poli
Poliert
Polished

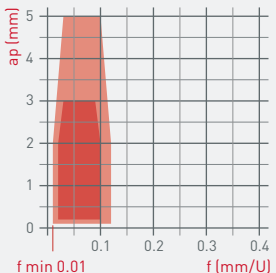

ap (mm)

f min 0.01 f (mm/U)

P	★★★★★
M	★★★★★
N	★★★★★
S	★★★★★

VCGT



p. 753

Finishing

Finishing

FN-0

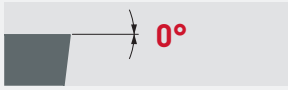

0°

Arête de coupe vive
Scharfe Schneidkante
Sharp edge

Poli
Poliert
Polished

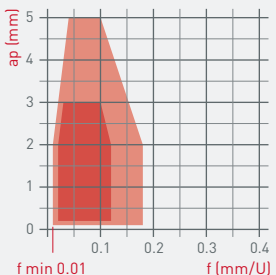

ap (mm)

f min 0.01 f (mm/U)

P	★★★
M	
N	★★★
S	

VCGW



p. 753

Finishing

FN-X8 CERMET



8°

Arête de coupe vive
Scharfe Schneidkante
Sharp edge

Poli
Poliert
Polished

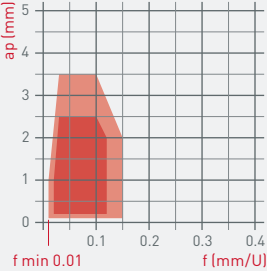

ap (mm)

f (mm/U)

f min 0.01

P	★★★★★
M	★★★
N	
S	

CCGT DCGT VCGT

p. 7.25 p. 7.43 p. 7.60

Semi-finishing

ENP-KX CERMET



8°

Arête de coupe honée
Schneidkantenverrundung
Honed edge

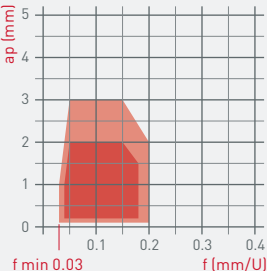

ap (mm)

f (mm/U)

f min 0.03

P	★★★★★
M	★★★
N	
S	

CCGT DCGT

p. 7.25 p. 7.43

Semi-finishing

EN-KM CERMET

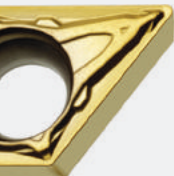

8°

Arête de coupe honée
Schneidkantenverrundung
Honed edge

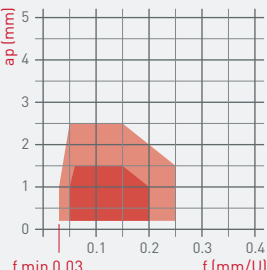

ap (mm)

f (mm/U)

f min 0.03

P	★★★★★
M	★★★
N	
S	

CCMT DCMT

p. 7.26 p. 7.44

Nuances

Sorten

Grades

Nuances Sorten Grades	Domaine d'application Anwendungsbereich Application area	Finishing / light machining	Semi-finishing / medium cut	Roughing / heavy machining	Géométries de coupe disponibles Verfügbare Spanformgeometrien Available cutting geometries	Résistance à l'usure Verschleißfestigkeit Wear resistance	Ténacité, résistance à la rupture Zähigkeit, Bruchwiderstand Toughness, crack resistance	Résistance à la température Bearbeitungswarmfestigkeit Machining heat resistance	Revêtement et couleur Beschichtung und Farbe Coating and colour	Recommandations spéciales Sonder-Empfehlungen Special recommendations
Carbide + PVD										
TiAlN	★★★★★ ★★★★★ ★★★★★ ★★★★	■	■	■	FN/ENP-X8 FN/ENP-X17 FN/ENP-X25 L/R-X10	■■■■■□	■■■■■□	■■■■■□	PVD	
HTA	★★★★★ ★★★★★ ★★★★★ ★★★★	■			FN-X8 FN-X17 FN-X25 L/R-X10 FN-K18 FN-0	■■■■■	■■■■■□	■■■■■□	PVD	
TiN	★★★★ ★★★★ ★★★★★	■	■	■	FN/ENP-X8 FN/ENP-X17 FN/ENP-X25 L/R-X10	■■■■□□	■■■■■□	■■■■□□	PVD	High resistance to edge build up
HTiN	★★★★ ★★★★ ★★★★★	■			FN-K18 FN-0	■■■■■□	■■■■■□	■■■■□□	PVD	High resistance to edge build up
TAC	★★★★★ ★★★★★ ★★★★★ ★★★★	■	■	■	EN-XF3 EN-XF2 EN-MF2 EN-HF	■■■■■□	■■■■■□	■■■■■□	PVD	
HTAC	★★★★★ ★★★★★ ★★★★★ ★★★★	■	■		EN-XF3 EN-XF2 EN-MF2	■■■■■	■■■■■□	■■■■■□	PVD	
TiX	★★★★★ ★★★★★ ★★★			■	EN-HF3	■■■■□□	■■■■■□	■■■■□□	PVD	Easy wear out control with TiN top layer
HTiX	★★★★★ ★★★★★ ★★★★★ ★★★	■	■		ENP-X20 EN-HF3	■■■■■□	■■■■■□	■■■■□□	PVD	Easy wear out control with TiN top layer
Tmax	★★★★★ ★★★★★ ★★★★★ ★★★★	■	■		EN-MF EN-HF	■■■■■□	■■■■■□	■■■■■□	PVD	
ZTA	★★★★★ ★★★★★ ★★★★★	■	■		ENP-X20	■■■■■□	■■■■■□	■■■■■□	PVD	perfect for titanium alloys & superalloys
TiAlX	★★★★ ★★★★ ★★★★★	■	■		X8 R-X10 X17 X25	■■■■■□	■■■■■□	■■■■■□	PVD	perfect for titanium alloys & superalloys
HTAX	★★★★ ★★★★ ★★★★★	■			X8 R-X10 X17 X25	■■■■■	■■■■■□	■■■■■□	PVD	perfect for titanium alloys & superalloys

ISO-LINE

Nuances

Sorten

Grades

Nuances Sorten Grades	Domaine d'application Anwendungsbereich Application area	Finishing / light machining	Semi-finishing / medium cut	Roughing / heavy machining	Géométries de coupe disponibles Verfügbare Spanformgeometrien Available cutting geometries	Résistance à l'usure Verschleißfestigkeit Wear resistance	Ténacité, résistance à la rupture Zähigkeit, Bruchwiderstand Toughness, crack resistance	Résistance à la température Bearbeitungswarmfestigkeit Machining heat resistance	Revêtement et couleur Beschichtung und Farbe Coating and colour	Recommandations spéciales Sonder-Empfehlungen Special recommendations
Carbide + CVD										
Ti4	★★★★★ ★★★		■	■	EN-MF EN-HF3 EN-HF	■■■■□	■■■■□	■■■■■	CVD	
Ti5	★★★★★ ★★★		■	■	EN-MF2 EN-HF	■■■■□	■■■■□	■■■■■	CVD	Easy wear out control with TiN top layer
HTi5	★★★★★ ★★★		■	■	EN-XF2 EN-MF2 EN-HF	■■■■■	■■■□□	■■■■■	CVD	Easy wear out control with TiN top layer
Ti6	★★★ ★★★★★ ★★★★		■	■	EN-HF3	■■■■□	■■■■□	■■■■■	CVD	
Carbide uncoated										
K10	★★★ ★★★		■		FN-X8 FN-X17 FN-X25 ELP-X10/ERP-X10 FN-K18 FN-0	■■■□□	■■■□□	■■□□□	uncoated	
K20	★★ ★★		■		FN/ENP-X8 FN/ENP-X17 FN/ENP-X25 ELP-X10/ERP-X10	■■□□□	■■■□□	■■□□□	uncoated	
CERMET										
CTA	★★★★★ ★★★		■		FN-X8	■■■■□	■■■■□	■■■■■	CERMET +PVD	
CT7	★★★★★ ★★★		■	■	ENP-KX EN-KM	■■■■□	■■■■□	■■■■■	CERMET + PVD	Easy wear out control with TiN top layer
HCT7	★★★★★ ★★★		■	■	ENP-KX EN-KM	■■■■■	■■■□□	■■■■■	CERMET + PVD	Easy wear out control with TiN top layer
CN6	★★★★		■		FN-X8 ENP-KX EN-KM	■■□□□	■■■■□	■■■■□	CERMET uncoated	

Porte-outils

Halter

Holders

80°

SCM



SCM

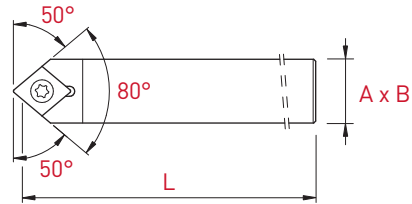

Plaquettes WSP Inserts	A x B	L	Art. N°
CC...-0602..	8 x 8	115	SCMCN-0808X-06
	10 x 10	115	SCMCN-1010X-06
	12 x 12	130	SCMCN-1212X-06
	12 x 12	90	SCMCN-1212G-06
	12.7 x 12.7	130	SCMCN-12.7X-06
	16 x 16	130	SCMCN-1616X-06
CC...-09T3..	16 x 16	75	SCMCN-1616F-06
	12 x 12	130	SCMCN-1212X-09
	12 x 12	90	SCMCN-1212G-09
	12.7 x 12.7	130	SCMCN-12.7X-09
	16 x 16	130	SCMCN-1616X-09
	16 x 16	75	SCMCN-1616F-09
	20 x 20	120	SCMCN-2020X-09



SCA

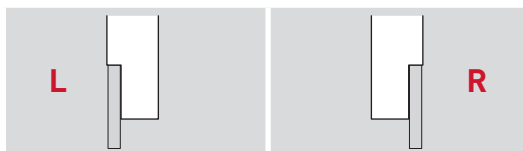
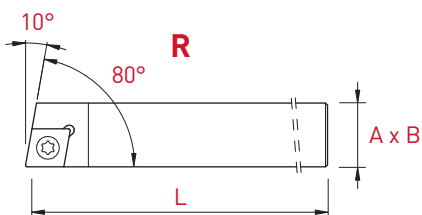

Plaquettes WSP Inserts	A x B	L	Art. N°	Art. N°
CC..-0602..	8 x 8	115	SCACL-0808X-06	SCACR-0808X-06
	10 x 10	115	SCACL-1010X-06	SCACR-1010X-06
	12 x 12	130	SCACL-1212X-06	SCACR-1212X-06
	12 x 12	90	SCACL-1212G-06	SCACR-1212G-06
	12.7 x 12.7	130	SCACL-12.7X-06	SCACR-12.7X-06
	16 x 16	130	SCACL-1616X-06	SCACR-1616X-06
	16 x 16	75	SCACL-1616F-06	SCACR-1616F-06
CC..-09T3..	12 x 12	130	SCACL-1212X-09	SCACR-1212X-09
	12 x 12	90	SCACL-1212G-09	SCACR-1212G-09
	12.7 x 12.7	130	SCACL-12.7X-09	SCACR-12.7X-09
	16 x 16	130	SCACL-1616X-09	SCACR-1616X-09
	16 x 16	75	SCACL-1616F-09	SCACR-1616F-09
	20 x 20	120	SCACL-2020X-09	SCACR-2020X-09

Porte-outils

Halter

Holders

80°

SCL



SCL

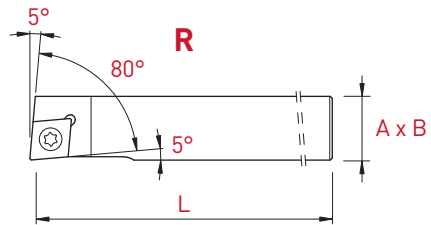

Plaquettes WSP Inserts	A x B	L	Art. N°	Art. N°
CC..-0602..	8 x 8	115	SCLCL-0808X-06	SCLCR-0808X-06
	10 x 10	115	SCLCL-1010X-06	SCLCR-1010X-06
	12 x 12	130	SCLCL-1212X-06	SCLCR-1212X-06
	12 x 12	90	SCLCL-1212G-06	SCLCR-1212G-06
	12.7 x 12.7	130	SCLCL-12.7X-06	SCLCR-12.7X-06
	16 x 16	130	SCLCL-1616X-06	SCLCR-1616X-06
	16 x 16	75	SCLCL-1616F-06	SCLCR-1616F-06
CC..-09T3..	12 x 12	130	SCLCL-1212X-09	SCLCR-1212X-09
	12 x 12	90	SCLCL-1212G-09	SCLCR-1212G-09
	12.7 x 12.7	130	SCLCL-12.7X-09	SCLCR-12.7X-09
	16 x 16	130	SCLCL-1616X-09	SCLCR-1616X-09
	16 x 16	75	SCLCL-1616F-09	SCLCR-1616F-09
	20 x 20	120	SCLCL-2020X-09	SCLCR-2020X-09

ISO-LINE

Porte-outils avec arrosage intégré
 Halter mit integrierter Kühlmittelzufuhr
 Holders with integrated coolant supply

80°

SCL-JET

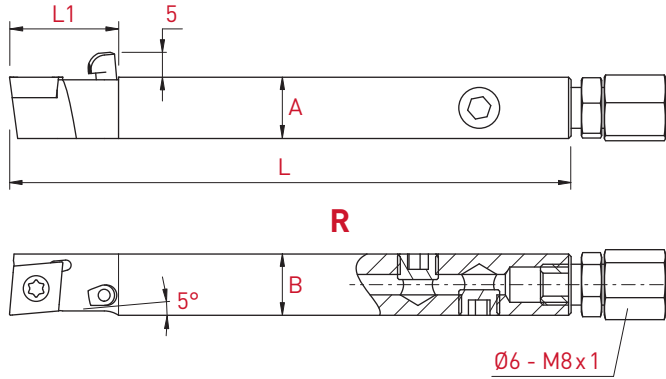

Plaquettes WSP Inserts	A x B	L	L1	Art. N°	Art. N°
CC...-0602..	10 x 10	110	21	SCLCL-1010J-06-JET	SCLCR-1010J-06-JET
	12 x 12	110	21	SCLCL-1212J-06-JET	SCLCR-1212J-06-JET
	12.7 x 12.7	110	21	SCLCL-12.7J-06-JET	SCLCR-12.7J-06-JET
	16 x 16	110	21	SCLCL-1616J-06-JET	SCLCR-1616J-06-JET
CC...-09T3..	12 x 12	110	21	SCLCL-1212J-09-JET	SCLCR-1212J-09-JET
	12.7 x 12.7	110	21	SCLCL-12.7J-09-JET	SCLCR-12.7J-09-JET
	16 x 16	110	21	SCLCL-1616J-09-JET	SCLCR-1616J-09-JET
	20 x 20	110	21	SCLCL-2020J-09-JET	SCLCR-2020J-09-JET

Porte-outils intérieurs amincis

Verjüngte Innenhalter

Thinned internal holders

80°

A-SCLCR/L

new

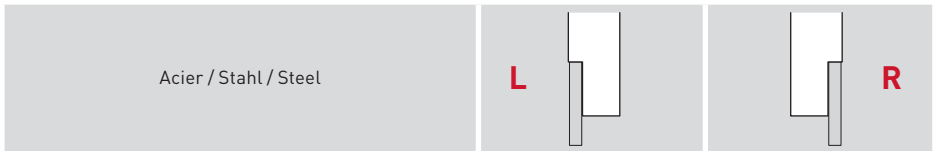
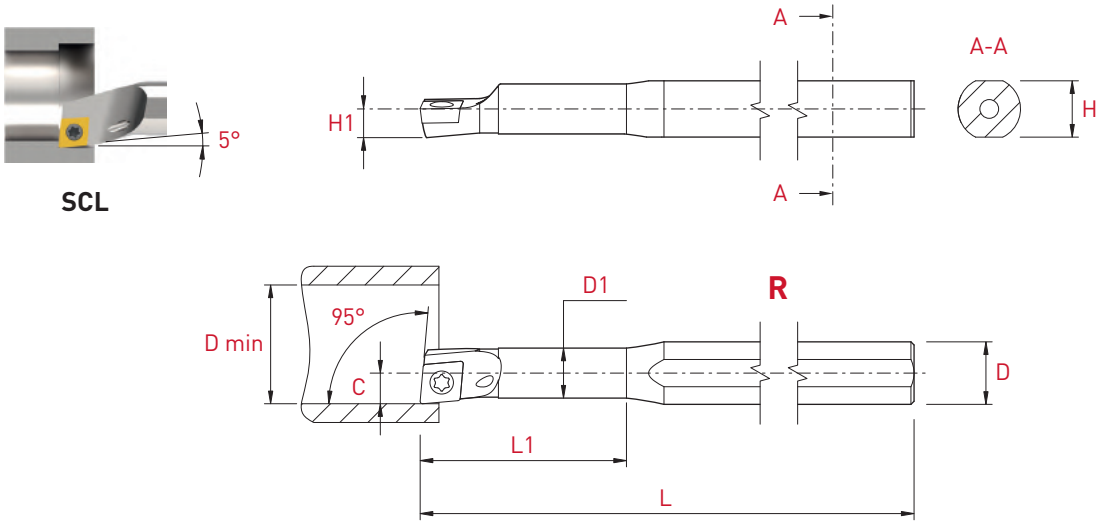

Plaquettes WSP Inserts	Acier / Stahl / Steel								Art. N°	Art. N°
	D	D min	D1	C	H1	L	L1	H		
CC...-0602..	8	8	6	4	4	100	25	7	A0608H-SCLCL-06	A0608H-SCLCR-06
	10	12	8	6	5	110	32	9	A0810J-SCLCL-06	A0810J-SCLCR-06
	12	14	10	7	6	125	38	11	A1012K-SCLCL-06	A1012K-SCLCR-06

Pour barres d'alésage For boring bar Für Borstange	Pièces de rechange Ersatzteile Spare parts	
	Art. N°	Art. N°
A0608H_ / A0810J_	V-M2.5X4.8-T8	C-T8
A1012K_	V-M2.5X5.8-T8	

new

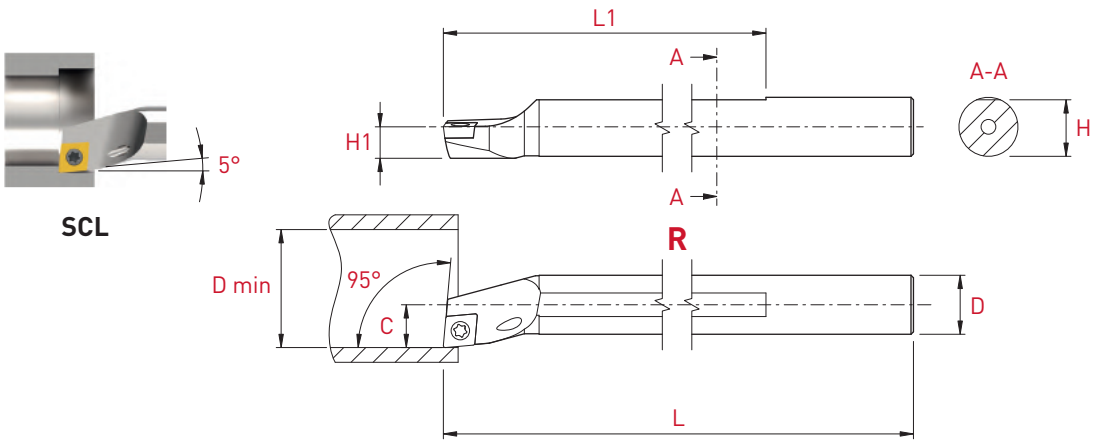



Acier / Stahl / Steel								L	R
-----------------------	--	--	--	--	--	--	--	---	---

Plaquettes WSP Inserts	D	D min	C	H1	L	L1	H	Art. N°	Art. N°
	CC...-0602	8	11	5	4	80	74	7.5	A08F-SCLCL-06
10		13	7	5	100	85	9.5	A10H-SCLCL-06	A10H-SCLCR-06
12		16	9	6	125	95	11.5	A12K-SCLCL-06	A12K-SCLCR-06
CC...-09T3	16	20	11	8	150	117	15.5	A16M-SCLCL-09	A16M-SCLCR-09

Carbure de tungstène / Hartmetall / Solid carbide								Art. N°	Art. N°
---	--	--	--	--	--	--	--	---------	---------

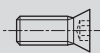
CC...-0602	D	D min	C	H1	L	L1	H	Art. N°	Art. N°
	8	9	5	4	125	-	7.5	E08K-SCLCL 06	E08K-SCLCR 06
10	11	6	5	125	-	9.5	E10K-SCLCL-06	E10K-SCLCR 06	
12	13	8	6	150	-	11.5	E12M-SCLCL 06	E12M-SCLCR 06	

Pour barres d'alésage For boring bar Für Borstange	Pièces de rechange Ersatzteile Spare parts	
		
	Art. N°	Art. N°
	A08F_ / E08K_	V-M2.5X4.8-T8
A10H_ / E10H_	V-M2.5X5.8-T8	C-T8
A16M_	V-M3.5X7.2-T15-ISO	C-T15

Plaquettes en métal dur

VHM-Wendeplatten

Solid carbide inserts

80°

CCGT-X8



CCGT
FN-X8

R	Art. N°	PVD			non revêtu unbeschichtet uncoated	
		TiAlN	HTA	TiN	K10	K20
		P M N S	P M N S	P M N		
0.05	CCGT-0602005-FN-X8	■	■	■	■	■
0.1	CCGT-060201-FN-X8	■	■	■	■	■
0.2	CCGT-060202-FN-X8	■	■	■	■	■
0.4	CCGT-060204-FN-X8	■	■	■	■	■
0.05	CCGT-09T3005-FN-X8	■	■	■	■	■
0.1	CCGT-09T301-FN-X8	■	■	■	■	■
0.2	CCGT-09T302-FN-X8	■	■	■	■	■
0.4	CCGT-09T304-FN-X8	■	■	■	■	■



CCGT
ENP-X8

R	Art. N°	PVD		non revêtu unbeschichtet uncoated
		TiAlN	TiN	K20
		P M N S	P M N	N
0.05	CCGT-0602005-ENP-X8	■	■	■
0.1	CCGT-060201-ENP-X8	■	■	■
0.2	CCGT-060202-ENP-X8	■	■	■
0.4	CCGT-060204-ENP-X8	■	■	■
0.05	CCGT-09T3005-ENP-X8	■	■	■
0.1	CCGT-09T301-ENP-X8	■	■	■
0.2	CCGT-09T302-ENP-X8	■	■	■
0.4	CCGT-09T304-ENP-X8	■	■	■





CCGT
FN-X17

R	Art. N°	PVD			non revêtu unbeschichtet uncoated	
		TiAlN	HTA	TiN	K10	K20
		P M N S	P M N S	P M N		
0.05	CCGT-0602005-FN-X17	■	■	■	■	■
0.1	CCGT-060201-FN-X17	■	■	■	■	■
0.2	CCGT-060202-FN-X17	■	■	■	■	■
0.4	CCGT-060204-FN-X17	■	■	■	■	■
0.05	CCGT-09T3005-FN-X17	■	■	■	■	■
0.1	CCGT-09T301-FN-X17	■	■	■	■	■
0.2	CCGT-09T302-FN-X17	■	■	■	■	■
0.4	CCGT-09T304-FN-X17	■	■	■	■	■
0.8	CCGT-09T308-FN-X17	■	■	■	■	■



CCGT
ENP-X17

R	Art. N°	PVD		non revêtu unbeschichtet uncoated
		TiAlN	TiN	K20
		P M N S	P M N	
0.05	CCGT-0602005-ENP-X17	■	■	■
0.1	CCGT-060201-ENP-X17	■	■	■
0.2	CCGT-060202-ENP-X17	■	■	■
0.4	CCGT-060204-ENP-X17	■	■	■
0.05	CCGT-09T3005-ENP-X17	■	■	■
0.1	CCGT-09T301-ENP-X17	■	■	■
0.2	CCGT-09T302-ENP-X17	■	■	■
0.4	CCGT-09T304-ENP-X17	■	■	■
0.8	CCGT-09T308-ENP-X17	■	■	■



Plaquettes en métal dur

VHM-Wendeplatten

Solid carbide inserts

80°

CCGT-X20



**CCGT
ENP-X20**

PVD	
ZTA	HTiX
<input type="checkbox"/>	<input type="checkbox"/>
<input checked="" type="checkbox"/> M	<input checked="" type="checkbox"/> M
<input checked="" type="checkbox"/> N	<input checked="" type="checkbox"/> N
<input checked="" type="checkbox"/> S	<input checked="" type="checkbox"/> S

R	H	Art. N°	ZTA	HTiX
~6 R	0.1	CCGT-060201-ENP-X20	■	
	0.2	CCGT-060202-ENP-X20	■	■
	0.4	CCGT-060204-ENP-X20	■	■
~9 R	0.1	CCGT-09T301-ENP-X20	■	
	0.2	CCGT-09T302-ENP-X20	■	■
	0.4	CCGT-09T304-ENP-X20	■	■
	0.8	CCGT-09T308-ENP-X20	■	■

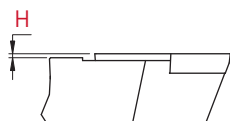
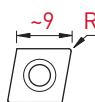

Plaquettes en métal dur

VHM-Wendeplatten

Solid carbide inserts

80°

CCMT-XF3

CCMT-XF2

CCMT-MF2

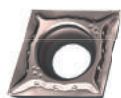

CCMT
EN-XF3

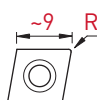

R	Art. N°	PVD	
		TAC	HTAC
0.2	CCMT-060202-EN-XF3	■	■
0.4	CCMT-060204-EN-XF3	■	■
0.2	CCMT-09T302-EN-XF3	■	■
0.4	CCMT-09T304-EN-XF3	■	■

PVD	
P	P
M	M
N	N
S	S
TAC	HTAC



CCMT
EN-XF2



R	Art. N°	PVD		CVD
		TAC	HTAC	HTi5
0.2	CCMT-060202-EN-XF2	■	■	■
0.4	CCMT-060204-EN-XF2	■	■	■
0.2	CCMT-09T302-EN-XF2	■	■	■
0.4	CCMT-09T304-EN-XF2	■	■	■

PVD		CVD
P	P	P
M	M	M
N	N	
S	S	
TAC	HTAC	HTi5

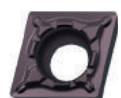

CCMT
EN-MF2

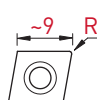

R	Art. N°	PVD		CVD	
		TAC	HTAC	Ti5	HTi5
0.2	CCMT-060202-EN-MF2	■	■	■	■
0.4	CCMT-060204-EN-MF2	■	■	■	■
0.2	CCMT-09T302-EN-MF2	■	■	■	■
0.4	CCMT-09T304-EN-MF2	■	■	■	■
0.8	CCMT-09T308-EN-MF2	■	■	■	■

PVD		CVD	
P	P	P	P
M	M	M	M
N	N		
S	S		
TAC	HTAC	Ti5	HTi5

Plaquettes en métal dur
VHM-Wendeplatten
Solid carbide inserts

80°

CCMT-MF
CCMT-HF3
CCMT-HF



**CCMT
EN-MF**

R	Art. N°	PVD		CVD	
		Tmax	Ti4	Ti4	Ti4
0.2	CCMT-060202-EN-MF	■	■	■	■
0.4	CCMT-060204-EN-MF	■	■	■	■
0.2	CCMT-09T302-EN-MF	■	■	■	■
0.4	CCMT-09T304-EN-MF	■	■	■	■

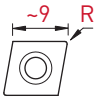

**CCMT
EN-HF3**

R	Art. N°	PVD		CVD	
		TiX	HTiX	Ti6	Ti6
0.2	CCMT-060202-EN-HF3	■	■	■	■
0.4	CCMT-060204-EN-HF3	■	■	■	■
0.2	CCMT-09T302-EN-HF3	■	■	■	■
0.4	CCMT-09T304-EN-HF3	■	■	■	■
0.8	CCMT-09T308-EN-HF3	■	■	■	■



**CCMT
EN-HF**

R	Art. N°	PVD		CVD		
		Tmax	TAC	Ti4	Ti5	HTi5
0.2	CCMT-060202-EN-HF	■	■	■	■	■
0.4	CCMT-060204-EN-HF	■	■	■	■	■
0.8	CCMT-060208-EN-HF	■	■	■	■	■
0.2	CCMT-09T302-EN-HF	■	■	■	■	■
0.4	CCMT-09T304-EN-HF	■	■	■	■	■
0.8	CCMT-09T308-EN-HF	■	■	■	■	■



Plaquettes CERMET
 CERMET-Wendeplatten
 CERMET inserts

80°

CCGT-X8
 CCGT-KX



CCGT
 FN-X8

		CERMET	
		PVD	non revêtu unbeschichtet uncoated
		<input checked="" type="checkbox"/> P <input checked="" type="checkbox"/> M <input type="checkbox"/> <input type="checkbox"/>	<input checked="" type="checkbox"/> P <input type="checkbox"/> <input type="checkbox"/> <input type="checkbox"/>
R	Art. N°	CTA	CN6
0.05	CCGT-0602005-FN-X8	<input checked="" type="checkbox"/>	<input checked="" type="checkbox"/>
0.1	CCGT-060201-FN-X8	<input checked="" type="checkbox"/>	<input checked="" type="checkbox"/>
0.2	CCGT-060202-FN-X8	<input checked="" type="checkbox"/>	<input checked="" type="checkbox"/>
0.05	CCGT-09T3005-FN-X8	<input checked="" type="checkbox"/>	<input checked="" type="checkbox"/>
0.1	CCGT-09T301-FN-X8	<input checked="" type="checkbox"/>	<input checked="" type="checkbox"/>
0.2	CCGT-09T302-FN-X8	<input checked="" type="checkbox"/>	<input checked="" type="checkbox"/>
0.4	CCGT-09T304-FN-X8	<input checked="" type="checkbox"/>	<input checked="" type="checkbox"/>



CCGT
 ENP-KX

		CERMET		
		PVD		non revêtu unbeschichtet uncoated
		<input checked="" type="checkbox"/> P <input checked="" type="checkbox"/> M <input type="checkbox"/> <input type="checkbox"/>	<input checked="" type="checkbox"/> P <input checked="" type="checkbox"/> M <input type="checkbox"/> <input type="checkbox"/>	<input checked="" type="checkbox"/> P <input type="checkbox"/> <input type="checkbox"/> <input type="checkbox"/>
R	Art. N°	CT7	HCT7	CN6
0.1	CCGT-060201-ENP-KX	<input checked="" type="checkbox"/>	<input checked="" type="checkbox"/>	<input checked="" type="checkbox"/>
0.2	CCGT-060202-ENP-KX	<input checked="" type="checkbox"/>	<input checked="" type="checkbox"/>	<input checked="" type="checkbox"/>
0.4	CCGT-060204-ENP-KX	<input checked="" type="checkbox"/>	<input checked="" type="checkbox"/>	<input checked="" type="checkbox"/>
0.1	CCGT-09T301-ENP-KX	<input checked="" type="checkbox"/>	<input checked="" type="checkbox"/>	<input checked="" type="checkbox"/>
0.2	CCGT-09T302-ENP-KX	<input checked="" type="checkbox"/>	<input checked="" type="checkbox"/>	<input checked="" type="checkbox"/>
0.4	CCGT-09T304-ENP-KX	<input checked="" type="checkbox"/>	<input checked="" type="checkbox"/>	<input checked="" type="checkbox"/>





CCMT
 EN-KM

		CERMET		
		PVD		non revêtu unbeschichtet uncoated
		P	P	P
		M	M	
		CT7	HCT7	CN6
R	Art. N°			
0.2	CCMT-060202-EN-KM	■	■	■
0.4	CCMT-060204-EN-KM	■	■	■
0.2	CCMT-09T302-EN-KM	■	■	■
0.4	CCMT-09T304-EN-KM	■	■	■
0.8	CCMT-09T308-EN-KM	■	■	■

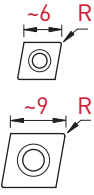

Porte-outils

Halter

Holders

55°

SDN



SDN

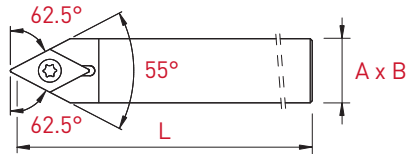

Plaquettes WSP Inserts	A x B	L	Art. N°
DC...-0702..	8 x 8	115	SDNCN-0808X-07
	10 x 10	115	SDNCN-1010X-07
	12 x 12	130	SDNCN-1212X-07
	12 x 12	90	SDNCN-1212G-07
	12.7 x 12.7	130	SDNCN-12.7X-07
	16 x 16	130	SDNCN-1616X-07
	16 x 16	75	SDNCN-1616F-07
DC...-11T3..	12 x 12	130	SDNCN-1212X-11
	12 x 12	90	SDNCN-1212G-11
	12.7 x 12.7	130	SDNCN-12.7X-11
	16 x 16	130	SDNCN-1616X-11
	16 x 16	75	SDNCN-1616F-11
	20 x 20	120	SDNCN-2020X-11



SDA

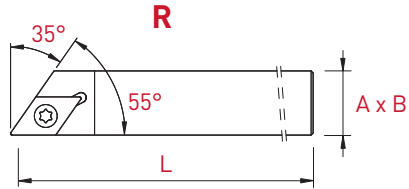

Plaquettes WSP Inserts	A x B	L	Art. N°	Art. N°
DC..-0702..	8 x 8	115	SDACL-0808X-07	SDACR-0808X-07
	10 x 10	115	SDACL-1010X-07	SDACR-1010X-07
	12 x 12	130	SDACL-1212X-07	SDACR-1212X-07
	12 x 12	90	SDACL-1212G-07	SDACR-1212G-07
	12.7 x 12.7	130	SDACL-12.7X-07	SDACR-12.7X-07
	16 x 16	130	SDACL-1616X-07	SDACR-1616X-07
	16 x 16	75	SDACL-1616F-07	SDACR-1616F-07
DC..-11T3..	12 x 12	130	SDACL-1212X-11	SDACR-1212X-11
	12 x 12	90	SDACL-1212G-11	SDACR-1212G-11
	12.7 x 12.7	130	SDACL-12.7X-11	SDACR-12.7X-11
	16 x 16	130	SDACL-1616X-11	SDACR-1616X-11
	16 x 16	75	SDACL-1616F-11	SDACR-1616F-11
	20 x 20	120	SDACL-2020X-11	SDACR-2020X-11

Porte-outils

Halter

Holders

55°

SDJ



SDJ

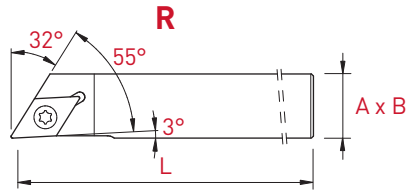

Plaquettes WSP Inserts	A x B	L	Art. N°	Art. N°
DC...0702..	8 x 8	115	SDJCL-0808X-07	SDJCR-0808X-07
	10 x 10	115	SDJCL-1010X-07	SDJCR-1010X-07
	12 x 12	130	SDJCL-1212X-07	SDJCR-1212X-07
	12 x 12	90	SDJCL-1212G-07	SDJCR-1212G-07
	12.7 x 12.7	130	SDJCL-12.7X-07	SDJCR-12.7X-07
	16 x 16	130	SDJCL-1616X-07	SDJCR-1616X-07
	16 x 16	75	SDJCL-1616F-07	SDJCR-1616F-07
	20 x 20	120	SDJCL-2020X-07	SDJCR-2020X-07
DC...11T3..	12 x 12	130	SDJCL-1212X-11	SDJCR-1212X-11
	12 x 12	90	SDJCL-1212G-11	SDJCR-1212G-11
	12.7 x 12.7	130	SDJCL-12.7X-11	SDJCR-12.7X-11
	16 x 16	130	SDJCL-1616X-11	SDJCR-1616X-11
	16 x 16	75	SDJCL-1616F-11	SDJCR-1616F-11
	20 x 20	120	SDJCL-2020X-11	SDJCR-2020X-11

ISO-LINE

Porte-outils avec arrosage intégré
 Halter mit integrierter Kühlmittelzufuhr
 Holders with integrated coolant supply

55°

SDJ-JET

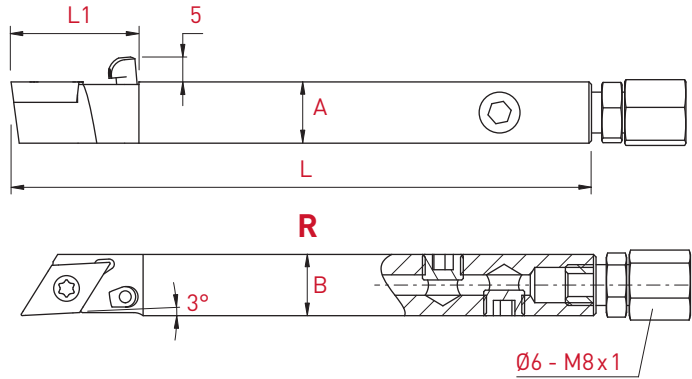

Plaquettes WSP Inserts	A x B	L	L1	Art. N°	Art. N°
DC...-0702..	10 x 10	110	20	SDJCL-1010J-07-JET	SDJCR-1010J-07-JET
	12 x 12	110	20	SDJCL-1212J-07-JET	SDJCR-1212J-07-JET
	12.7 x 12.7	110	20	SDJCL-12.7J-07-JET	SDJCR-12.7J-07-JET
	16 x 16	110	20	SDJCL-1616J-07-JET	SDJCR-1616J-07-JET
	20 x 20	110	20	SDJCL-2020J-07-JET	SDJCR-2020J-07-JET
DC...-11T3..	12 x 12	110	23	SDJCL-1212J-11-JET	SDJCR-1212J-11-JET
	12.7 x 12.7	110	23	SDJCL-12.7J-11-JET	SDJCR-12.7J-11-JET
	16 x 16	110	23	SDJCL-1616J-11-JET	SDJCR-1616J-11-JET
	20 x 20	110	23	SDJCL-2020J-11-JET	SDJCR-2020J-11-JET

Porte-outils

Halter

Holders

55°

SDH



SDH

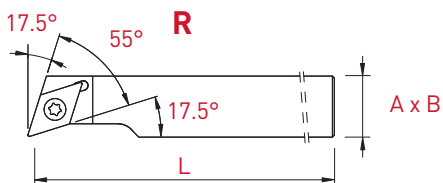

Plaquettes WSP Inserts	A x B	L	Art. N°	Art. N°
DC...-0702..	10 x 10	115	SDHCL-1010X-07	SDHCR-1010X-07
	12 x 12	130	SDHCL-1212X-07	SDHCR-1212X-07
	12 x 12	90	SDHCL-1212G-07	SDHCR-1212G-07
	12.7 x 12.7	130	SDHCL-12.7X-07	SDHCR-12.7X-07
	16 x 16	130	SDHCL-1616X-07	SDHCR-1616X-07
	16 x 16	75	SDHCL-1616F-07	SDHCR-1616F-07
DC...-11T3..	16 x 16	130	SDHCL-1616X-11	SDHCR-1616X-11
	16 x 16	75	SDHCL-1616F-11	SDHCR-1616F-11
	20 x 20	120	SDHCL-2020X-11	SDHCR-2020X-11

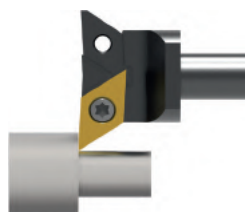

SDU

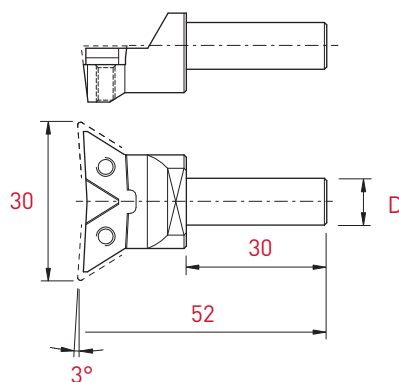

Plaquettes WSP Inserts	D	Art. N°
DC..-11T3..	10	SDUC-D10X-11

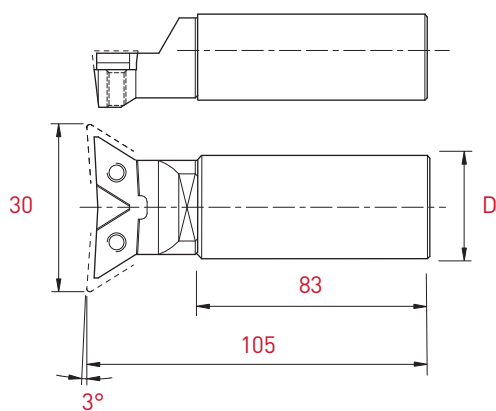

Plaquettes WSP Inserts	D	Art. N°
DC..-11T3..	20	SDUC-D20X-11
	25.4	SDUC-D25.4X-11

Porte-outils intérieurs amincis

Verjüngte Innenhalter

Thinned internal holders

55°

A-SDQCR/L

new

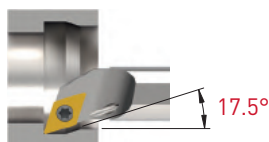

SDQ

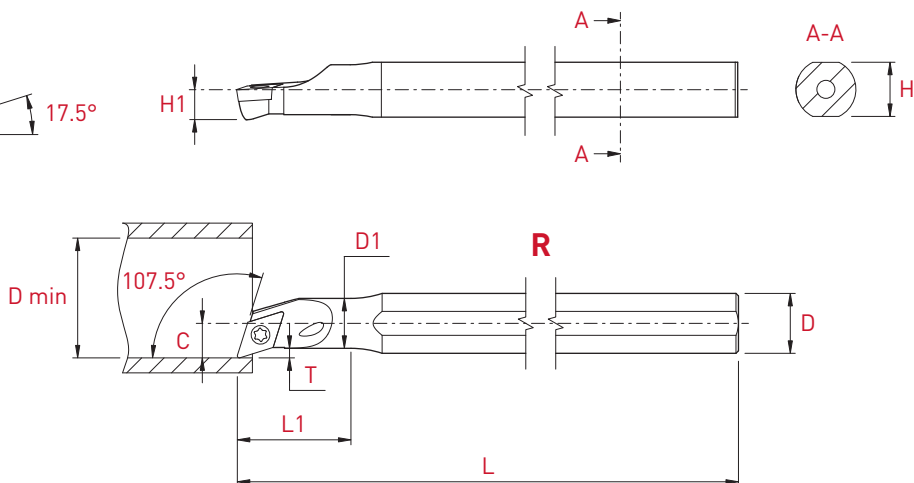

Acier / Stahl / Steel										L	R
-----------------------	--	--	--	--	--	--	--	--	--	---	---

Plaquettes WSP Inserts	D	D min	D1	T	C	H1	L	L1	H	Art. N°	Art. N°
	DC...-0702	10	12.5	8	2.4	7	5	100	22	9	A0810H-SDQCL-07
12		15.5	10	2.9	9	6	125	28	11	A1012K-SDQCL-07	A1012K-SDQCR-07

Pour barres d'alésage For boring bar Für Borstange	Pièces de rechange Ersatzteile Spare parts	
	Art. N°	Art. N°
A0810H_	V-M2.5X4.8-T8	C-T8
A1012K_	V-M2.5X5.8-T8	

new

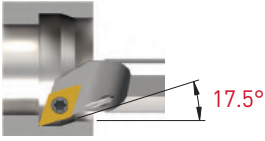

SDQ

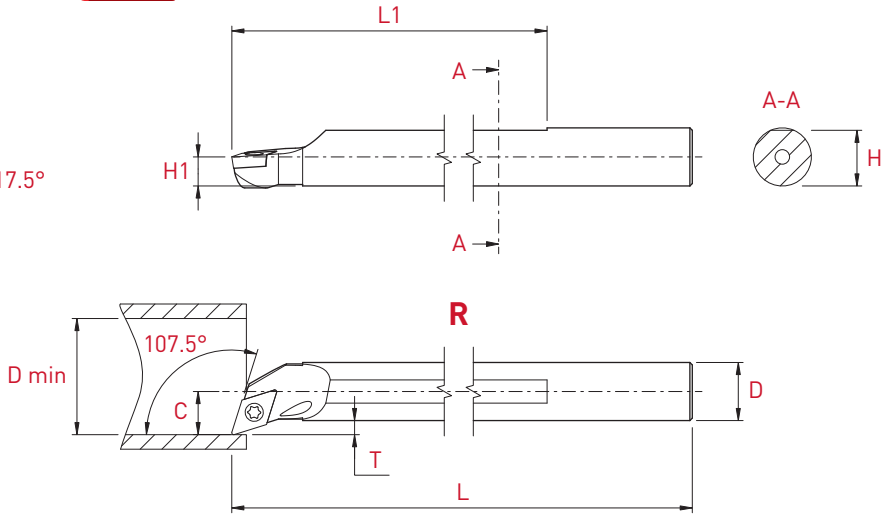

Acier / Stahl / Steel									L	R
Plaquettes WSP Inserts	D	D min	T	C	H1	L	L1	H	Art. N°	Art. N°
DC...-0702	10	14	2.4	7	4.5	100	85	9	A10H-SDQCL-07	A10H-SDQCR-07
	12	17	2.9	9	6	125	95	11.5	A12K-SDQCL-07	A12K-SDQCR-07
	16	21	2.9	11	8	150	117	15.5	A16M-SDQCL-07	A16M-SDQCR-07

Carbure de tungstène / Hartmetall / Solid carbide										
	D	D min	T	C	H1	L	L1	H	Art. N°	Art. N°
DC...-0702	10	13	2.4	7.5	5	125	-	9.5	E10K-SDQCL-07	E10K-SDQCR-07
	12	17	2.9	9	6	150	-	11.5	E12M-SDQCL-07	E12M-SDQCR-07

Pièces de rechange Ersatzteile Spare parts	
Art. N°	Art. N°
V-M2.5X5.8-T8	C-T8

Porte-outils intérieurs amincis

Verjüngte Innenhalter

Thinned internal holders

55°

A-SDUCR/L

new

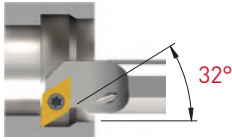

SDU

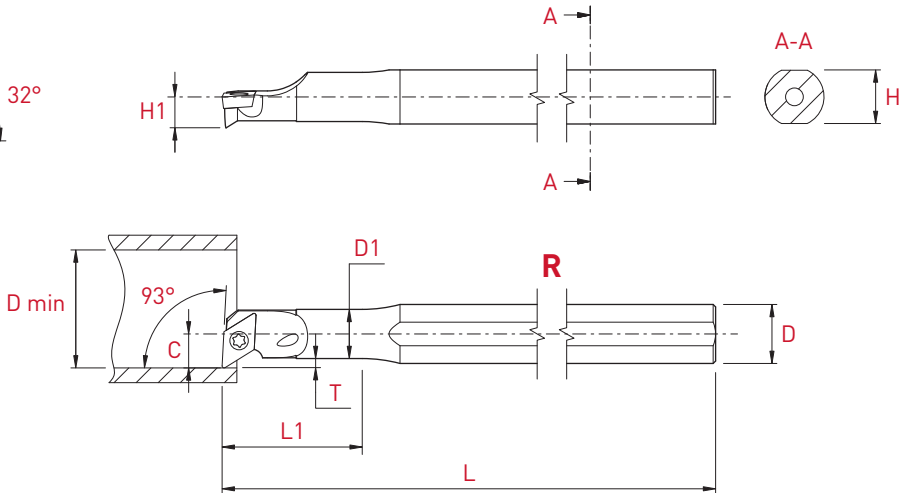

Acier / Stahl / Steel

L

R

Plaquettes WSP Inserts	D	D min	D1	T	C	H1	L	H	Art. N°	Art. N°
	DC...0702	10 12	12.5 15.5	7 9	1.9 2.9	5 6	100 125	22 28	9 11	A0810H-SDUCL-07 A1012K-SDUCL-07

Pour barres d'alésage
For boring bar
Für Borstange

Pièces de rechange
Ersatzteile
Spare parts

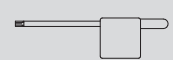
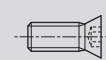

Art. N°

Art. N°

A0810H_

V-M2.5X4.8-T8

C-T8

A1012K_

V-M2.5X5.8-T8

new

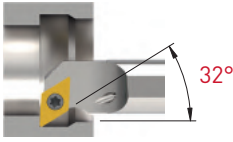

SDU

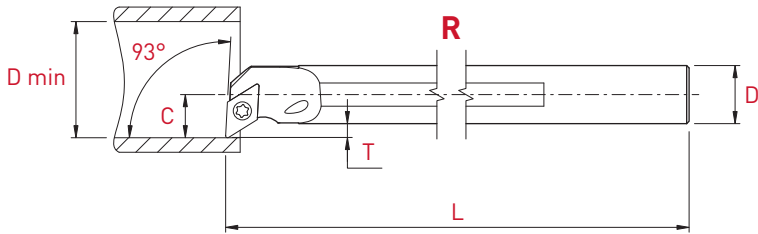
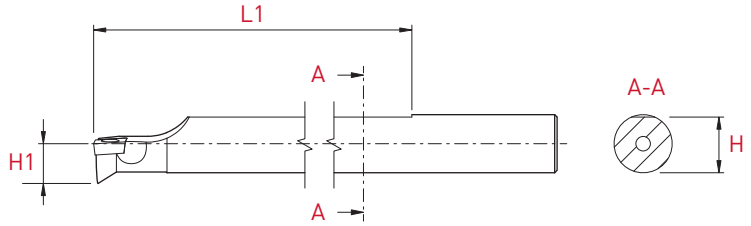

Acier / Stahl / Steel

L

R

Plaquettes WSP Inserts	Acier / Stahl / Steel								 	
	D	D min	T	C	H1	L	L1	H	Art. N°	Art. N°
DC...-0702	10	14	1.9	7	5	100	85	9.5	A10H-SDUCL-07	A10H-SDUCR-07
	12	17	2.9	9	6	125	95	11.5	A12K-SDUCL-07	A12K-SDUCR-07
	16	21	2.9	11	8	150	117	15.5	A16M-SDUCL-07	A16M-SDUCR-07

Carbure de tungstène / Hartmetall / Solid carbide

DC...-0702	Carbure de tungstène / Hartmetall / Solid carbide								 	
	D	D min	T	C	H1	L	L1	H	Art. N°	Art. N°
DC...-0702	10	14	1.9	7	5	125	-	9.5	E10K-SDUCL-07	E10K-SDUCR-07
	12	17	2.9	9	6	150	-	11.5	E12M-SDUCL-07	E12M-SDUCR-07

Pièces de rechange
Ersatzteile
Spare parts

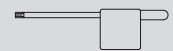

Art. N°

Art. N°

V-M2.5X5.8-T8

C-T8

Plaquettes en métal dur
VHM-Wendepplatten
Solid carbide inserts

55°

DCGT-X8



DCGT
FN-X8

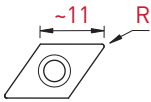
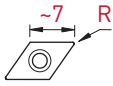

R	Art. N°	PVD					non revêtu unbeschichtet uncoated	
		TiAlN	HTA	TiAlX	HTAX	TiN	K10	K20
0.05	DCGT-0702005-FN-X8	<input checked="" type="checkbox"/>	<input checked="" type="checkbox"/>	<input checked="" type="checkbox"/>	<input checked="" type="checkbox"/>	<input checked="" type="checkbox"/>	<input type="checkbox"/>	<input type="checkbox"/>
0.08	DCGT-0702008-FN-X8	<input checked="" type="checkbox"/>	<input checked="" type="checkbox"/>	<input checked="" type="checkbox"/>	<input checked="" type="checkbox"/>	<input checked="" type="checkbox"/>	<input type="checkbox"/>	<input type="checkbox"/>
0.1	DCGT-070201-FN-X8	<input checked="" type="checkbox"/>	<input checked="" type="checkbox"/>	<input checked="" type="checkbox"/>	<input checked="" type="checkbox"/>	<input checked="" type="checkbox"/>	<input type="checkbox"/>	<input type="checkbox"/>
0.15	DCGT-0702015-FN-X8	<input checked="" type="checkbox"/>	<input checked="" type="checkbox"/>	<input checked="" type="checkbox"/>	<input checked="" type="checkbox"/>	<input checked="" type="checkbox"/>	<input type="checkbox"/>	<input type="checkbox"/>
0.2	DCGT-070202-FN-X8	<input checked="" type="checkbox"/>	<input checked="" type="checkbox"/>	<input checked="" type="checkbox"/>	<input checked="" type="checkbox"/>	<input checked="" type="checkbox"/>	<input type="checkbox"/>	<input type="checkbox"/>
0.4	DCGT-070204-FN-X8	<input checked="" type="checkbox"/>	<input checked="" type="checkbox"/>	<input checked="" type="checkbox"/>	<input checked="" type="checkbox"/>	<input checked="" type="checkbox"/>	<input type="checkbox"/>	<input type="checkbox"/>
0.05	DCGT-11T3005-FN-X8	<input checked="" type="checkbox"/>	<input checked="" type="checkbox"/>	<input checked="" type="checkbox"/>	<input checked="" type="checkbox"/>	<input checked="" type="checkbox"/>	<input type="checkbox"/>	<input type="checkbox"/>
0.08	DCGT-11T3008-FN-X8	<input checked="" type="checkbox"/>	<input checked="" type="checkbox"/>	<input checked="" type="checkbox"/>	<input checked="" type="checkbox"/>	<input checked="" type="checkbox"/>	<input type="checkbox"/>	<input type="checkbox"/>
0.1	DCGT-11T301-FN-X8	<input checked="" type="checkbox"/>	<input checked="" type="checkbox"/>	<input checked="" type="checkbox"/>	<input checked="" type="checkbox"/>	<input checked="" type="checkbox"/>	<input type="checkbox"/>	<input type="checkbox"/>
0.15	DCGT-11T3015-FN-X8	<input checked="" type="checkbox"/>	<input checked="" type="checkbox"/>	<input checked="" type="checkbox"/>	<input checked="" type="checkbox"/>	<input checked="" type="checkbox"/>	<input type="checkbox"/>	<input type="checkbox"/>
0.2	DCGT-11T302-FN-X8	<input checked="" type="checkbox"/>	<input checked="" type="checkbox"/>	<input checked="" type="checkbox"/>	<input checked="" type="checkbox"/>	<input checked="" type="checkbox"/>	<input type="checkbox"/>	<input type="checkbox"/>
0.4	DCGT-11T304-FN-X8	<input checked="" type="checkbox"/>	<input checked="" type="checkbox"/>	<input checked="" type="checkbox"/>	<input checked="" type="checkbox"/>	<input checked="" type="checkbox"/>	<input type="checkbox"/>	<input type="checkbox"/>



DCGT
ENP-X8

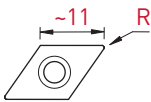
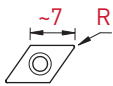

R	Art. N°	PVD		non revêtu unbeschichtet uncoated
		TiAlN	TiN	K20
0.05	DCGT-0702005-ENP-X8	<input checked="" type="checkbox"/>	<input checked="" type="checkbox"/>	<input type="checkbox"/>
0.08	DCGT-0702008-ENP-X8	<input checked="" type="checkbox"/>	<input checked="" type="checkbox"/>	<input type="checkbox"/>
0.1	DCGT-070201-ENP-X8	<input checked="" type="checkbox"/>	<input checked="" type="checkbox"/>	<input type="checkbox"/>
0.15	DCGT-0702015-ENP-X8	<input checked="" type="checkbox"/>	<input checked="" type="checkbox"/>	<input type="checkbox"/>
0.2	DCGT-070202-ENP-X8	<input checked="" type="checkbox"/>	<input checked="" type="checkbox"/>	<input type="checkbox"/>
0.4	DCGT-070204-ENP-X8	<input checked="" type="checkbox"/>	<input checked="" type="checkbox"/>	<input type="checkbox"/>
0.05	DCGT-11T3005-ENP-X8	<input checked="" type="checkbox"/>	<input checked="" type="checkbox"/>	<input type="checkbox"/>
0.08	DCGT-11T3008-ENP-X8	<input checked="" type="checkbox"/>	<input checked="" type="checkbox"/>	<input type="checkbox"/>
0.1	DCGT-11T301-ENP-X8	<input checked="" type="checkbox"/>	<input checked="" type="checkbox"/>	<input type="checkbox"/>
0.15	DCGT-11T3015-ENP-X8	<input checked="" type="checkbox"/>	<input checked="" type="checkbox"/>	<input type="checkbox"/>
0.2	DCGT-11T302-ENP-X8	<input checked="" type="checkbox"/>	<input checked="" type="checkbox"/>	<input type="checkbox"/>
0.4	DCGT-11T304-ENP-X8	<input checked="" type="checkbox"/>	<input checked="" type="checkbox"/>	<input type="checkbox"/>



DCGT
FN-X17

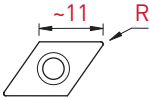
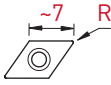

R	Art. N°	PVD					non revêtu unbeschichtet uncoated	
		TiAlN	HTA	TiAlX	HTAX	TiN	K10	K20
0.05	DCGT-0702005-FN-X17	<input checked="" type="checkbox"/>	<input checked="" type="checkbox"/>	<input checked="" type="checkbox"/>	<input checked="" type="checkbox"/>	<input checked="" type="checkbox"/>	<input type="checkbox"/>	<input type="checkbox"/>
0.08	DCGT-0702008-FN-X17	<input checked="" type="checkbox"/>	<input checked="" type="checkbox"/>	<input checked="" type="checkbox"/>	<input checked="" type="checkbox"/>	<input checked="" type="checkbox"/>	<input type="checkbox"/>	<input type="checkbox"/>
0.1	DCGT-070201-FN-X17	<input checked="" type="checkbox"/>	<input checked="" type="checkbox"/>	<input checked="" type="checkbox"/>	<input checked="" type="checkbox"/>	<input checked="" type="checkbox"/>	<input type="checkbox"/>	<input type="checkbox"/>
0.15	DCGT-0702015-FN-X17	<input checked="" type="checkbox"/>	<input checked="" type="checkbox"/>	<input checked="" type="checkbox"/>	<input checked="" type="checkbox"/>	<input checked="" type="checkbox"/>	<input type="checkbox"/>	<input type="checkbox"/>
0.2	DCGT-070202-FN-X17	<input checked="" type="checkbox"/>	<input checked="" type="checkbox"/>	<input checked="" type="checkbox"/>	<input checked="" type="checkbox"/>	<input checked="" type="checkbox"/>	<input type="checkbox"/>	<input type="checkbox"/>
0.4	DCGT-070204-FN-X17	<input checked="" type="checkbox"/>	<input checked="" type="checkbox"/>	<input checked="" type="checkbox"/>	<input checked="" type="checkbox"/>	<input checked="" type="checkbox"/>	<input type="checkbox"/>	<input type="checkbox"/>
0.05	DCGT-11T3005-FN-X17	<input checked="" type="checkbox"/>	<input checked="" type="checkbox"/>	<input checked="" type="checkbox"/>	<input checked="" type="checkbox"/>	<input checked="" type="checkbox"/>	<input type="checkbox"/>	<input type="checkbox"/>
0.08	DCGT-11T3008-FN-X17	<input checked="" type="checkbox"/>	<input checked="" type="checkbox"/>	<input checked="" type="checkbox"/>	<input checked="" type="checkbox"/>	<input checked="" type="checkbox"/>	<input type="checkbox"/>	<input type="checkbox"/>
0.1	DCGT-11T301-FN-X17	<input checked="" type="checkbox"/>	<input checked="" type="checkbox"/>	<input checked="" type="checkbox"/>	<input checked="" type="checkbox"/>	<input checked="" type="checkbox"/>	<input type="checkbox"/>	<input type="checkbox"/>
0.15	DCGT-11T3015-FN-X17	<input checked="" type="checkbox"/>	<input checked="" type="checkbox"/>	<input checked="" type="checkbox"/>	<input checked="" type="checkbox"/>	<input checked="" type="checkbox"/>	<input type="checkbox"/>	<input type="checkbox"/>
0.2	DCGT-11T302-FN-X17	<input checked="" type="checkbox"/>	<input checked="" type="checkbox"/>	<input checked="" type="checkbox"/>	<input checked="" type="checkbox"/>	<input checked="" type="checkbox"/>	<input type="checkbox"/>	<input type="checkbox"/>
0.4	DCGT-11T304-FN-X17	<input checked="" type="checkbox"/>	<input checked="" type="checkbox"/>	<input checked="" type="checkbox"/>	<input checked="" type="checkbox"/>	<input checked="" type="checkbox"/>	<input type="checkbox"/>	<input type="checkbox"/>
0.8	DCGT-11T308-FN-X17	<input checked="" type="checkbox"/>	<input checked="" type="checkbox"/>	<input checked="" type="checkbox"/>	<input checked="" type="checkbox"/>	<input checked="" type="checkbox"/>	<input type="checkbox"/>	<input type="checkbox"/>



DCGT
ENP-X17

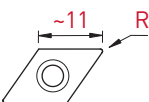
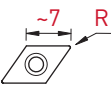

R	Art. N°	PVD		non revêtu unbeschichtet uncoated
		TiAlN	TiN	K20
0.05	DCGT-0702005-ENP-X17	<input checked="" type="checkbox"/>	<input checked="" type="checkbox"/>	<input type="checkbox"/>
0.08	DCGT-0702008-ENP-X17	<input checked="" type="checkbox"/>	<input checked="" type="checkbox"/>	<input type="checkbox"/>
0.1	DCGT-070201-ENP-X17	<input checked="" type="checkbox"/>	<input checked="" type="checkbox"/>	<input type="checkbox"/>
0.15	DCGT-0702015-ENP-X17	<input checked="" type="checkbox"/>	<input checked="" type="checkbox"/>	<input type="checkbox"/>
0.2	DCGT-070202-ENP-X17	<input checked="" type="checkbox"/>	<input checked="" type="checkbox"/>	<input type="checkbox"/>
0.4	DCGT-070204-ENP-X17	<input checked="" type="checkbox"/>	<input checked="" type="checkbox"/>	<input type="checkbox"/>
0.05	DCGT-11T3005-ENP-X17	<input checked="" type="checkbox"/>	<input checked="" type="checkbox"/>	<input type="checkbox"/>
0.08	DCGT-11T3008-ENP-X17	<input checked="" type="checkbox"/>	<input checked="" type="checkbox"/>	<input type="checkbox"/>
0.1	DCGT-11T301-ENP-X17	<input checked="" type="checkbox"/>	<input checked="" type="checkbox"/>	<input type="checkbox"/>
0.15	DCGT-11T3015-ENP-X17	<input checked="" type="checkbox"/>	<input checked="" type="checkbox"/>	<input type="checkbox"/>
0.2	DCGT-11T302-ENP-X17	<input checked="" type="checkbox"/>	<input checked="" type="checkbox"/>	<input type="checkbox"/>
0.4	DCGT-11T304-ENP-X17	<input checked="" type="checkbox"/>	<input checked="" type="checkbox"/>	<input type="checkbox"/>
0.8	DCGT-11T308-ENP-X17	<input checked="" type="checkbox"/>	<input checked="" type="checkbox"/>	<input type="checkbox"/>

Plaquettes en métal dur

VHM-Wendepplatten

Solid carbide inserts

55°

DCGT-X25



DCGT
FN-X25

R	Art. N°	PVD			non revêtu unbeschichtet uncoated	
		TiAlN	HTA	TiN	K10	K20
		<input type="checkbox"/>	<input type="checkbox"/>	<input type="checkbox"/>	<input type="checkbox"/>	<input type="checkbox"/>
		<input type="checkbox"/>	<input type="checkbox"/>	<input type="checkbox"/>	<input type="checkbox"/>	<input type="checkbox"/>
		<input type="checkbox"/>	<input type="checkbox"/>	<input type="checkbox"/>	<input type="checkbox"/>	<input type="checkbox"/>
		<input type="checkbox"/>	<input type="checkbox"/>	<input type="checkbox"/>	<input type="checkbox"/>	<input type="checkbox"/>
0.05	DCGT-0702005-FN-X25	<input checked="" type="checkbox"/>	<input checked="" type="checkbox"/>	<input checked="" type="checkbox"/>	<input checked="" type="checkbox"/>	<input checked="" type="checkbox"/>
0.1	DCGT-070201-FN-X25	<input checked="" type="checkbox"/>	<input checked="" type="checkbox"/>	<input checked="" type="checkbox"/>	<input checked="" type="checkbox"/>	<input checked="" type="checkbox"/>
0.2	DCGT-070202-FN-X25	<input checked="" type="checkbox"/>	<input checked="" type="checkbox"/>	<input checked="" type="checkbox"/>	<input checked="" type="checkbox"/>	<input checked="" type="checkbox"/>
0.4	DCGT-070204-FN-X25	<input checked="" type="checkbox"/>	<input checked="" type="checkbox"/>	<input checked="" type="checkbox"/>	<input checked="" type="checkbox"/>	<input checked="" type="checkbox"/>
0.05	DCGT-11T3005-FN-X25	<input checked="" type="checkbox"/>	<input checked="" type="checkbox"/>	<input checked="" type="checkbox"/>	<input checked="" type="checkbox"/>	<input checked="" type="checkbox"/>
0.1	DCGT-11T301-FN-X25	<input checked="" type="checkbox"/>	<input checked="" type="checkbox"/>	<input checked="" type="checkbox"/>	<input checked="" type="checkbox"/>	<input checked="" type="checkbox"/>
0.2	DCGT-11T302-FN-X25	<input checked="" type="checkbox"/>	<input checked="" type="checkbox"/>	<input checked="" type="checkbox"/>	<input checked="" type="checkbox"/>	<input checked="" type="checkbox"/>
0.4	DCGT-11T304-FN-X25	<input checked="" type="checkbox"/>	<input checked="" type="checkbox"/>	<input checked="" type="checkbox"/>	<input checked="" type="checkbox"/>	<input checked="" type="checkbox"/>
0.8	DCGT-11T308-FN-X25	<input checked="" type="checkbox"/>	<input checked="" type="checkbox"/>	<input checked="" type="checkbox"/>	<input checked="" type="checkbox"/>	<input checked="" type="checkbox"/>

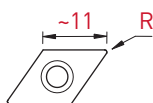

DCGT
ENP-X25

R	Art. N°	PVD			non revêtu unbeschichtet uncoated
		TiAlN	TiAlX	TiN	K20
		<input type="checkbox"/>	<input type="checkbox"/>	<input type="checkbox"/>	<input type="checkbox"/>
		<input type="checkbox"/>	<input type="checkbox"/>	<input type="checkbox"/>	<input type="checkbox"/>
		<input type="checkbox"/>	<input type="checkbox"/>	<input type="checkbox"/>	<input type="checkbox"/>
		<input type="checkbox"/>	<input type="checkbox"/>	<input type="checkbox"/>	<input type="checkbox"/>
0.05	DCGT-0702005-ENP-X25	<input checked="" type="checkbox"/>	<input checked="" type="checkbox"/>	<input checked="" type="checkbox"/>	<input checked="" type="checkbox"/>
0.1	DCGT-070201-ENP-X25	<input checked="" type="checkbox"/>	<input checked="" type="checkbox"/>	<input checked="" type="checkbox"/>	<input checked="" type="checkbox"/>
0.2	DCGT-070202-ENP-X25	<input checked="" type="checkbox"/>	<input checked="" type="checkbox"/>	<input checked="" type="checkbox"/>	<input checked="" type="checkbox"/>
0.4	DCGT-070204-ENP-X25	<input checked="" type="checkbox"/>	<input checked="" type="checkbox"/>	<input checked="" type="checkbox"/>	<input checked="" type="checkbox"/>
0.05	DCGT-11T3005-ENP-X25	<input checked="" type="checkbox"/>	<input checked="" type="checkbox"/>	<input checked="" type="checkbox"/>	<input checked="" type="checkbox"/>
0.1	DCGT-11T301-ENP-X25	<input checked="" type="checkbox"/>	<input checked="" type="checkbox"/>	<input checked="" type="checkbox"/>	<input checked="" type="checkbox"/>
0.2	DCGT-11T302-ENP-X25	<input checked="" type="checkbox"/>	<input checked="" type="checkbox"/>	<input checked="" type="checkbox"/>	<input checked="" type="checkbox"/>
0.4	DCGT-11T304-ENP-X25	<input checked="" type="checkbox"/>	<input checked="" type="checkbox"/>	<input checked="" type="checkbox"/>	<input checked="" type="checkbox"/>
0.8	DCGT-11T308-ENP-X25	<input checked="" type="checkbox"/>	<input checked="" type="checkbox"/>	<input checked="" type="checkbox"/>	<input checked="" type="checkbox"/>

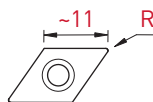
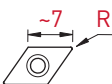



DCCT
 ENP-X20

PVD	
ZTA	HTiX
<input type="checkbox"/>	<input type="checkbox"/>
<input checked="" type="checkbox"/> M	<input checked="" type="checkbox"/> M
<input checked="" type="checkbox"/> N	<input checked="" type="checkbox"/> N
<input checked="" type="checkbox"/> S	<input checked="" type="checkbox"/> S

R	H	Art. N°	ZTA	HTiX
0.1	0.2	DCCT-070201-ENP-X20	■	
0.2	0.2	DCCT-070202-ENP-X20	■	■
0.4	0.2	DCCT-070204-ENP-X20	■	■
0.1	0.25	DCCT-11T301-ENP-X20	■	
0.2	0.25	DCCT-11T302-ENP-X20	■	■
0.4	0.25	DCCT-11T304-ENP-X20	■	■
0.8	0.25	DCCT-11T308-ENP-X20	■	■

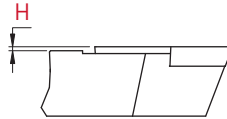
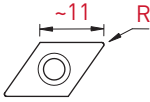
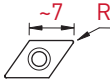

Plaquettes en métal dur
VHM-Wendepplatten
Solid carbide inserts

55°

DCMT-XF3
DCMT-XF2
DCMT-MF2

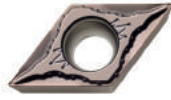

DCMT
EN-XF3

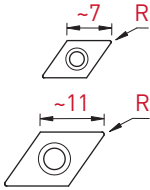

R	Art. N°	PVD	
		TAC	HTAC
0.2	DCMT-070202-EN-XF3	<input checked="" type="checkbox"/>	<input checked="" type="checkbox"/>
0.4	DCMT-070204-EN-XF3	<input checked="" type="checkbox"/>	<input checked="" type="checkbox"/>
0.2	DCMT-11T302-EN-XF3	<input checked="" type="checkbox"/>	<input checked="" type="checkbox"/>
0.4	DCMT-11T304-EN-XF3	<input checked="" type="checkbox"/>	<input checked="" type="checkbox"/>

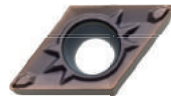

DCMT
EN-XF2

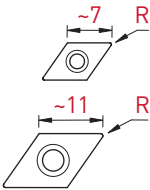

R	Art. N°	PVD		CVD
		TAC	HTAC	HT15
0.2	DCMT-070202-EN-XF2	<input checked="" type="checkbox"/>	<input checked="" type="checkbox"/>	<input checked="" type="checkbox"/>
0.4	DCMT-070204-EN-XF2	<input checked="" type="checkbox"/>	<input checked="" type="checkbox"/>	<input checked="" type="checkbox"/>
0.2	DCMT-11T302-EN-XF2	<input checked="" type="checkbox"/>	<input checked="" type="checkbox"/>	<input checked="" type="checkbox"/>
0.4	DCMT-11T304-EN-XF2	<input checked="" type="checkbox"/>	<input checked="" type="checkbox"/>	<input checked="" type="checkbox"/>



DCMT
EN-MF2

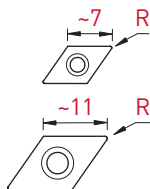

R	Art. N°	PVD		CVD	
		TAC	HTAC	Ti5	HT15
0.2	DCMT-070202-EN-MF2	<input checked="" type="checkbox"/>	<input checked="" type="checkbox"/>	<input checked="" type="checkbox"/>	<input checked="" type="checkbox"/>
0.4	DCMT-070204-EN-MF2	<input checked="" type="checkbox"/>	<input checked="" type="checkbox"/>	<input checked="" type="checkbox"/>	<input checked="" type="checkbox"/>
0.2	DCMT-11T302-EN-MF2	<input checked="" type="checkbox"/>	<input checked="" type="checkbox"/>	<input checked="" type="checkbox"/>	<input checked="" type="checkbox"/>
0.4	DCMT-11T304-EN-MF2	<input checked="" type="checkbox"/>	<input checked="" type="checkbox"/>	<input checked="" type="checkbox"/>	<input checked="" type="checkbox"/>
0.8	DCMT-11T308-EN-MF2	<input checked="" type="checkbox"/>	<input checked="" type="checkbox"/>	<input checked="" type="checkbox"/>	<input checked="" type="checkbox"/>

ISO-LINE

Plaquettes en métal dur
VHM-Wendplatten
Solid carbide inserts

55°

DCMT-MF
DCMT-HF3
DCMT-HF



**DCMT
EN-MF**

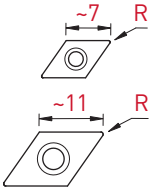

R	Art. N°	PVD		CVD	
		<input type="checkbox"/> P <input type="checkbox"/> M	<input type="checkbox"/> P <input type="checkbox"/> M	<input type="checkbox"/> P <input type="checkbox"/> M	<input type="checkbox"/> P <input type="checkbox"/> M
		Tmax		Ti4	
0.2	DCMT-070202-EN-MF	■		■	
0.4	DCMT-070204-EN-MF	■		■	
0.2	DCMT-11T302-EN-MF	■		■	
0.4	DCMT-11T304-EN-MF	■		■	



**DCMT
EN-HF3**

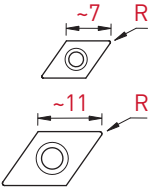

R	Art. N°	PVD		CVD	
		<input type="checkbox"/> P <input type="checkbox"/> M	<input type="checkbox"/> P <input type="checkbox"/> M	<input type="checkbox"/> P <input type="checkbox"/> M	<input type="checkbox"/> P <input type="checkbox"/> M
		TiX	HTiX	Ti6	
0.2	DCMT-070202-EN-HF3	■	■	■	
0.4	DCMT-070204-EN-HF3	■	■	■	
0.2	DCMT-11T302-EN-HF3	■	■	■	
0.4	DCMT-11T304-EN-HF3	■	■	■	
0.8	DCMT-11T308-EN-HF3	■	■	■	



**DCMT
EN-HF**

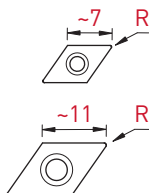

R	Art. N°	PVD		CVD		
		<input type="checkbox"/> P <input type="checkbox"/> M	<input type="checkbox"/> P <input type="checkbox"/> M	<input type="checkbox"/> P <input type="checkbox"/> M	<input type="checkbox"/> P <input type="checkbox"/> M	<input type="checkbox"/> P <input type="checkbox"/> M
		Tmax	TAC	Ti4	Ti5	HTi5
0.2	DCMT-070202-EN-HF	■	■	■	■	■
0.4	DCMT-070204-EN-HF	■	■	■	■	■
0.8	DCMT-070208-EN-HF	■	■	■	■	■
0.2	DCMT-11T302-EN-HF	■	■	■	■	■
0.4	DCMT-11T304-EN-HF	■	■	■	■	■
0.8	DCMT-11T308-EN-HF	■	■	■	■	■

Plaquettes CERMET
 CERMET-Wendeplatten
 CERMET inserts

55°

DCGT-X8
 DCGT-KX



DCGT
 FN-X8

		CERMET	
		PVD	non revêtu unbeschichtet uncoated
		<input checked="" type="checkbox"/> P <input checked="" type="checkbox"/> M <input type="checkbox"/> <input type="checkbox"/>	<input checked="" type="checkbox"/> P <input type="checkbox"/> <input type="checkbox"/> <input type="checkbox"/>
R	Art. N°	CTA	CN6
0.05	DCGT-0702005-FN-X8	<input checked="" type="checkbox"/>	<input checked="" type="checkbox"/>
0.1	DCGT-070201-FN-X8	<input checked="" type="checkbox"/>	<input checked="" type="checkbox"/>
0.2	DCGT-070202-FN-X8	<input checked="" type="checkbox"/>	<input checked="" type="checkbox"/>
0.05	DCGT-11T3005-FN-X8	<input checked="" type="checkbox"/>	<input checked="" type="checkbox"/>
0.1	DCGT-11T301-FN-X8	<input checked="" type="checkbox"/>	<input checked="" type="checkbox"/>
0.2	DCGT-11T302-FN-X8	<input checked="" type="checkbox"/>	<input checked="" type="checkbox"/>
0.4	DCGT-11T304-FN-X8	<input checked="" type="checkbox"/>	<input checked="" type="checkbox"/>

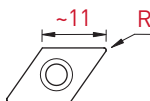
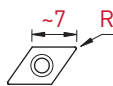

DCGT
 ENP-KX

		CERMET		
		PVD		non revêtu unbeschichtet uncoated
		<input checked="" type="checkbox"/> P <input checked="" type="checkbox"/> M <input type="checkbox"/> <input type="checkbox"/>	<input checked="" type="checkbox"/> P <input checked="" type="checkbox"/> M <input type="checkbox"/> <input type="checkbox"/>	<input checked="" type="checkbox"/> P <input type="checkbox"/> <input type="checkbox"/> <input type="checkbox"/>
R	Art. N°	CT7	HCT7	CN6
0.1	DCGT-070201-ENP-KX	<input checked="" type="checkbox"/>	<input checked="" type="checkbox"/>	<input checked="" type="checkbox"/>
0.2	DCGT-070202-ENP-KX	<input checked="" type="checkbox"/>	<input checked="" type="checkbox"/>	<input checked="" type="checkbox"/>
0.4	DCGT-070204-ENP-KX	<input checked="" type="checkbox"/>	<input checked="" type="checkbox"/>	<input checked="" type="checkbox"/>
0.1	DCGT-11T301-ENP-KX	<input checked="" type="checkbox"/>	<input checked="" type="checkbox"/>	<input checked="" type="checkbox"/>
0.2	DCGT-11T302-ENP-KX	<input checked="" type="checkbox"/>	<input checked="" type="checkbox"/>	<input checked="" type="checkbox"/>
0.4	DCGT-11T304-ENP-KX	<input checked="" type="checkbox"/>	<input checked="" type="checkbox"/>	<input checked="" type="checkbox"/>

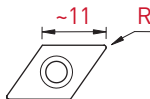
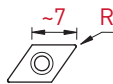

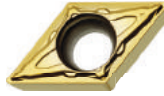

DCMT
 EN-KM

		CERMET		
		PVD		non revêtu unbeschichtet uncoated
		P	P	P
		M	M	
		<input type="checkbox"/>	<input type="checkbox"/>	<input type="checkbox"/>
		<input type="checkbox"/>	<input type="checkbox"/>	<input type="checkbox"/>
R	Art. N°	CT7	HCT7	CN6
0.2	DCMT-070202-EN-KM	■	■	■
0.4	DCMT-070204-EN-KM	■	■	■
0.2	DCMT-11T302-EN-KM	■	■	■
0.4	DCMT-11T304-EN-KM	■	■	■
0.8	DCMT-11T308-EN-KM	■	■	■

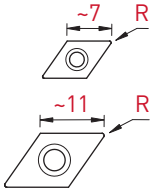

Porte-outils

Halter

Holders

35°

SVV



SVV

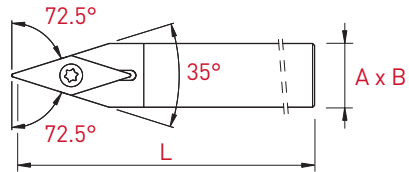

Plaquettes WSP Inserts	A x B	L	Art. N°
VC...1103..	8 x 8	115	SVVCN-0808X-11
	10 x 10	115	SVVCN-1010X-11
	12 x 12	130	SVVCN-1212X-11
	12 x 12	90	SVVCN-1212G-11
	12.7 x 12.7	130	SVVCN-12.7X-11
	16 x 16	130	SVVCN-1616X-11
	16 x 16	75	SVVCN-1616F-11
	20 x 20	120	SVVCN-2020X-11
VC...1303..	8 x 10	115	SVVCN-0810X-13
	10 x 10	115	SVVCN-1010X-13
	12 x 12	130	SVVCN-1212X-13
	12 x 12	90	SVVCN-1212G-13
	12.7 x 12.7	130	SVVCN-12.7X-13
	16 x 16	130	SVVCN-1616X-13
	16 x 16	75	SVVCN-1616F-13
	20 x 20	120	SVVCN-2020X-13
VC...1604..	12 x 12	130	SVVCN-1212X-16
	12 x 12	90	SVVCN-1212G-16
	12.7 x 12.7	130	SVVCN-12.7X-16
	16 x 16	130	SVVCN-1616X-16
	16 x 16	75	SVVCN-1616F-16
	20 x 20	120	SVVCN-2020X-16



SVA

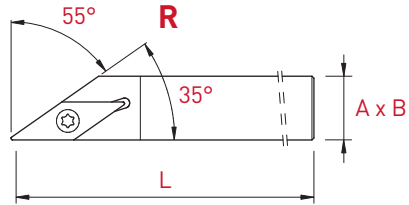

Plaquettes WSP Inserts	A x B	L	Art. N°	Art. N°
VC...1103..	8 x 8	115	SVACL-0808X-11	SVACR-0808X-11
	10 x 10	115	SVACL-1010X-11	SVACR-1010X-11
	12 x 12	130	SVACL-1212X-11	SVACR-1212X-11
	12 x 12	90	SVACL-1212G-11	SVACR-1212G-11
	12.7 x 12.7	130	SVACL-12.7X-11	SVACR-12.7X-11
	16 x 16	130	SVACL-1616X-11	SVACR-1616X-11
	16 x 16	75	SVACL-1616F-11	SVACR-1616F-11
	20 x 20	120	SVACL-2020X-11	SVACR-2020X-11
VC...1604..	12 x 12	130	SVACL-1212X-16	SVACR-1212X-16
	12 x 12	90	SVACL-1212G-16	SVACR-1212G-16
	12.7 x 12.7	130	SVACL-12.7X-16	SVACR-12.7X-16
	16 x 16	130	SVACL-1616X-16	SVACR-1616X-16
	16 x 16	75	SVACL-1616F-16	SVACR-1616F-16
	20 x 20	120	SVACL-2020X-16	SVACR-2020X-16

Porte-outils

Halter

Holders

35°

SVJ



SVJ

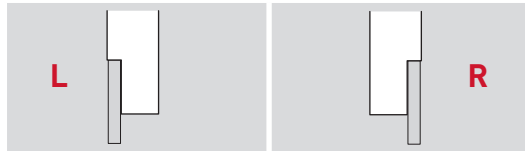
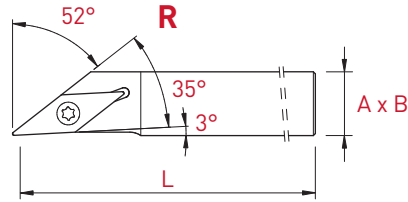

Plaquettes WSP Inserts	A x B	L	Art. N°	Art. N°
VC...1103..	8 x 8	115	SVJCL-0808X-11	SVJCR-0808X-11
	10 x 10	115	SVJCL-1010X-11	SVJCR-1010X-11
	12 x 12	130	SVJCL-1212X-11	SVJCR-1212X-11
	12 x 12	90	SVJCL-1212G-11	SVJCR-1212G-11
	12.7 x 12.7	130	SVJCL-12.7X-11	SVJCR-12.7X-11
	16 x 16	130	SVJCL-1616X-11	SVJCR-1616X-11
	16 x 16	75	SVJCL-1616F-11	SVJCR-1616F-11
	20 x 20	120	SVJCL-2020X-11	SVJCR-2020X-11
VC...1303..	8 x 10	115	SVJCL-0810X-13	SVJCR-0810X-13
	10 x 10	115	SVJCL-1010X-13	SVJCR-1010X-13
	12 x 12	130	SVJCL-1212X-13	SVJCR-1212X-13
	12 x 12	90	SVJCL-1212G-13	SVJCR-1212G-13
	12.7 x 12.7	130	SVJCL-12.7X-13	SVJCR-12.7X-13
	16 x 16	130	SVJCL-1616X-13	SVJCR-1616X-13
	16 x 16	75	SVJCL-1616F-13	SVJCR-1616F-13
	20 x 20	120	SVJCL-2020X-13	SVJCR-2020X-13
VC...1604..	12 x 12	130	SVJCL-1212X-16	SVJCR-1212X-16
	12 x 12	90	SVJCL-1212G-16	SVJCR-1212G-16
	12.7 x 12.7	130	SVJCL-12.7X-16	SVJCR-12.7X-16
	16 x 16	130	SVJCL-1616X-16	SVJCR-1616X-16
	16 x 16	75	SVJCL-1616F-16	SVJCR-1616F-16
	20 x 20	120	SVJCL-2020X-16	SVJCR-2020X-16

ISO-LINE

Porte-outils avec arrosage intégré
 Halter mit integrierter Kühlmittelzufuhr
 Holders with integrated coolant supply

35°

SVJ-JET



SVJ

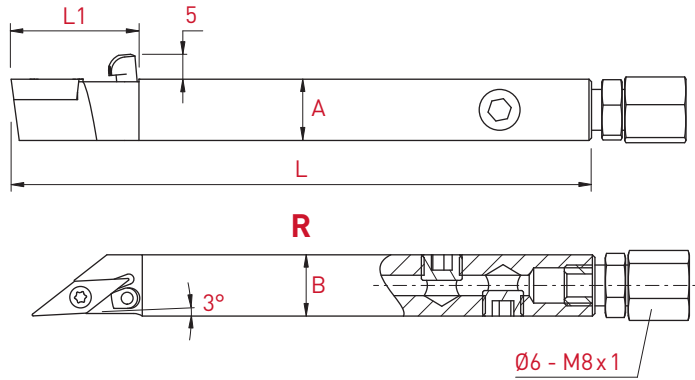

Plaquettes WSP Inserts	A x B	L	L1	Art. N°	
				L	R
VC...-1103..	10 x 10	110	21	SVJCL-1010J-11-JET	SVJCR-1010J-11-JET
	12 x 12	110	21	SVJCL-1212J-11-JET	SVJCR-1212J-11-JET
	12.7 x 12.7	110	21	SVJCL-12.7J-11-JET	SVJCR-12.7J-11-JET
	16 x 16	110	21	SVJCL-1616J-11-JET	SVJCR-1616J-11-JET
	20 x 20	110	21	SVJCL-2020J-11-JET	SVJCR-2020J-11-JET
VC...-1303..	10 x 10	110	26	SVJCL-1010J-13-JET	SVJCR-1010J-13-JET
	12 x 12	110	26	SVJCL-1212J-13-JET	SVJCR-1212J-13-JET
	12.7 x 12.7	110	26	SVJCL-12.7J-13-JET	SVJCR-12.7J-13-JET
	16 x 16	110	26	SVJCL-1616J-13-JET	SVJCR-1616J-13-JET
	20 x 20	110	26	SVJCL-2020J-13-JET	SVJCR-2020J-13-JET
VC...-1604..	12 x 12	110	30	SVJCL-1212J-16-JET	SVJCR-1212J-16-JET
	12.7 x 12.7	110	30	SVJCL-12.7J-16-JET	SVJCR-12.7J-16-JET
	16 x 16	110	30	SVJCL-1616J-16-JET	SVJCR-1616J-16-JET
	20 x 20	110	30	SVJCL-2020J-16-JET	SVJCR-2020J-16-JET

Porte-outils

Halter

Holders

35°

SVX



SVX

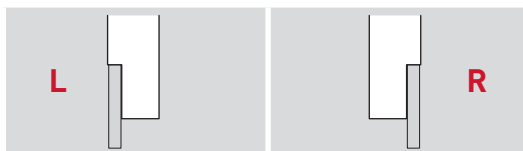
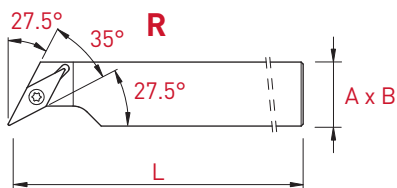

Plaquettes WSP Inserts	A x B	L	Art. N°	Art. N°
VC...-1103..	16 x 16	130	SVXCL-1616X-11	SVXCR-1616X-11
	16 x 16	75	SVXCL-1616F-11	SVXCR-1616F-11
	20 x 20	120	SVXCL-2020X-11	SVXCR-2020X-11

Porte-outils

Halter

Holders

35°

SV-CL/R



SV-CL/R

tournage arrière
rückwärts drehen
back turning

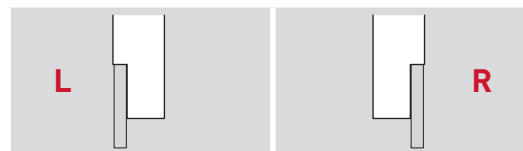
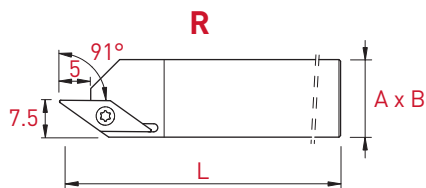

Plaquettes WSP Inserts	A x B	L	Art. N°	Art. N°
VCG...-1103..	12 x 12	130	SV-CL-1212X-11	SV-CR-1212X-11
	12 x 12	90	SV-CL-1212G-11	SV-CR-1212G-11
	12.7 x 12.7	130	SV-CL-12.7X-11	SV-CR-12.7X-11
	16 x 16	130	SV-CL-1616X-11	SV-CR-1616X-11
	16 x 16	75	SV-CL-1616F-11	SV-CR-1616F-11
	20 x 20	120	SV-CL-2020X-11	SV-CR-2020X-11

ISO-LINE

Porte-outils compatibles avec plaquettes VCGT ELP/ERP-FL/FR-X10°

Passende Halter zu den Wendplatten VCGT ELP/ERP-FL/FR-X10°

Holder compatible with inserts VCGT ELP/ERP-FL/FR-X10°

35°

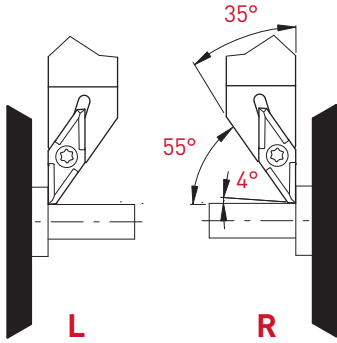

	Art. N°
R	SVACR-...-11
L	SVACL-...-11

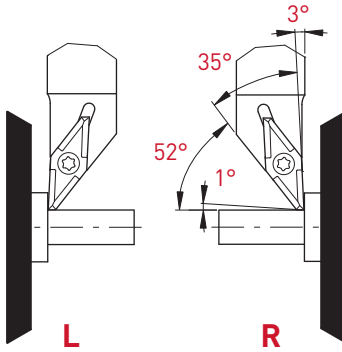

	Art. N°
R	SVJCR-...-11
L	SVJCL-...-11

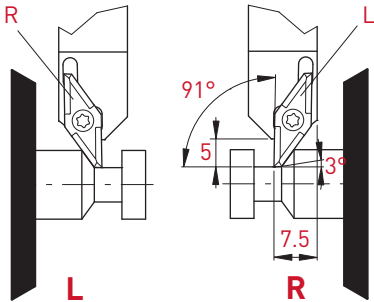

	Art. N°
R	SV-CR-...-11
L	SV-CL-...-11

Porte-outils intérieurs

Innenhalter

Internal holders

35°

A-SVUCR/L

new

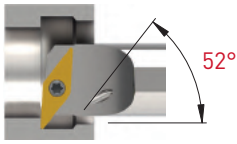

SVU

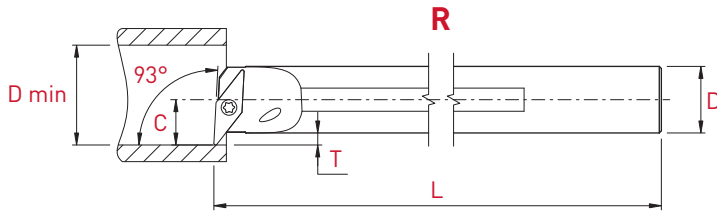
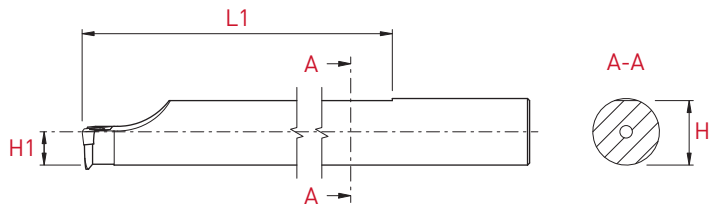

Acier / Stahl / Steel

L

R

Plaquettes WSP Inserts	D	Dmin	T	C	H1	L	L1	H	Art. N°	Art. N°
VC..-1103	16	21	3.1	11	8	150	118	15.5	A16M-SVUCL-11	A16M-SVUCR-11

Pièces de rechange
Ersatzteile
Spare parts



Art. N°

V-M2.5X5.8-T8

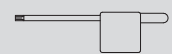

Art. N°

C-T8

Plaquettes en métal dur
VHM-Wendepplatten
Solid carbide inserts

35°

VCGT-L/R-X10

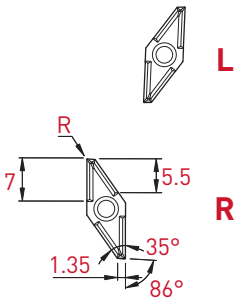

**VCGT
FL / FR-X10**

R	Art. N°
0.03	VCGT-1103003-FL-X10
0.08	VCGT-1103008-FL-X10
0.1	VCGT-110301-FL-X10
0.2	VCGT-110302-FL-X10
0.03	VCGT-1103003-FR-X10
0.08	VCGT-1103008-FR-X10
0.1	VCGT-110301-FR-X10
0.2	VCGT-110302-FR-X10

PVD					non revêtu unbeschichtet uncoated	
TiAlN	HTA	TiAlX	HTAX	TiN	K10	K20
<input checked="" type="checkbox"/>	<input checked="" type="checkbox"/>	<input checked="" type="checkbox"/>	<input checked="" type="checkbox"/>	<input checked="" type="checkbox"/>	<input type="checkbox"/>	<input type="checkbox"/>
<input checked="" type="checkbox"/>	<input checked="" type="checkbox"/>	<input checked="" type="checkbox"/>	<input checked="" type="checkbox"/>	<input checked="" type="checkbox"/>	<input checked="" type="checkbox"/>	<input checked="" type="checkbox"/>
<input checked="" type="checkbox"/>	<input checked="" type="checkbox"/>	<input checked="" type="checkbox"/>	<input checked="" type="checkbox"/>	<input checked="" type="checkbox"/>	<input checked="" type="checkbox"/>	<input checked="" type="checkbox"/>
<input checked="" type="checkbox"/>	<input checked="" type="checkbox"/>	<input checked="" type="checkbox"/>	<input checked="" type="checkbox"/>	<input checked="" type="checkbox"/>	<input checked="" type="checkbox"/>	<input checked="" type="checkbox"/>
<input checked="" type="checkbox"/>	<input checked="" type="checkbox"/>	<input checked="" type="checkbox"/>	<input checked="" type="checkbox"/>	<input checked="" type="checkbox"/>	<input checked="" type="checkbox"/>	<input checked="" type="checkbox"/>
<input checked="" type="checkbox"/>	<input checked="" type="checkbox"/>	<input checked="" type="checkbox"/>	<input checked="" type="checkbox"/>	<input checked="" type="checkbox"/>	<input checked="" type="checkbox"/>	<input checked="" type="checkbox"/>

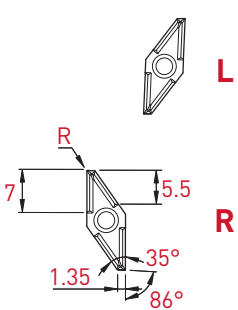

**VCGT
ELP/ERP-X10**

R	Art. N°
0.03	VCGT-1103003-ELP-X10
0.08	VCGT-1103008-ELP-X10
0.1	VCGT-110301-ELP-X10
0.2	VCGT-110302-ELP-X10
0.03	VCGT-1103003-ERP-X10
0.08	VCGT-1103008-ERP-X10
0.1	VCGT-110301-ERP-X10
0.2	VCGT-110302-ERP-X10

PVD					non revêtu unbeschichtet uncoated	
TiAlN	HTA	TiAlX	HTAX	TiN	K10	K20
<input checked="" type="checkbox"/>	<input checked="" type="checkbox"/>	<input checked="" type="checkbox"/>	<input checked="" type="checkbox"/>	<input checked="" type="checkbox"/>	<input type="checkbox"/>	<input type="checkbox"/>
<input checked="" type="checkbox"/>	<input checked="" type="checkbox"/>	<input checked="" type="checkbox"/>	<input checked="" type="checkbox"/>	<input checked="" type="checkbox"/>	<input checked="" type="checkbox"/>	<input checked="" type="checkbox"/>
<input checked="" type="checkbox"/>	<input checked="" type="checkbox"/>	<input checked="" type="checkbox"/>	<input checked="" type="checkbox"/>	<input checked="" type="checkbox"/>	<input checked="" type="checkbox"/>	<input checked="" type="checkbox"/>
<input checked="" type="checkbox"/>	<input checked="" type="checkbox"/>	<input checked="" type="checkbox"/>	<input checked="" type="checkbox"/>	<input checked="" type="checkbox"/>	<input checked="" type="checkbox"/>	<input checked="" type="checkbox"/>
<input checked="" type="checkbox"/>	<input checked="" type="checkbox"/>	<input checked="" type="checkbox"/>	<input checked="" type="checkbox"/>	<input checked="" type="checkbox"/>	<input checked="" type="checkbox"/>	<input checked="" type="checkbox"/>
<input checked="" type="checkbox"/>	<input checked="" type="checkbox"/>	<input checked="" type="checkbox"/>	<input checked="" type="checkbox"/>	<input checked="" type="checkbox"/>	<input checked="" type="checkbox"/>	<input checked="" type="checkbox"/>

Plaquettes en métal dur

VHM-Wendeplatten

Solid carbide inserts

35°

VCGT-K18

VCGW-0



VCGT
FN-K18

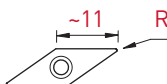

R	Art. N°	PVD		non revêtu unbeschichtet uncoated
		HTA	HTiN	K10
0.05	VCGT-1103005-FN-K18	■	■	■
0.1	VCGT-110301-FN-K18	■	■	■
0.2	VCGT-110302-FN-K18	■	■	■
0.4	VCGT-110304-FN-K18	■	■	■



VCGW
FN-0

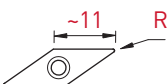

R	Art. N°	PVD		non revêtu unbeschichtet uncoated
		HTA	HTiN	K10
0.05	VCGW-1103005-FN-0	■	■	■
0.1	VCGW-110301-FN-0	■	■	■
0.2	VCGW-110302-FN-0	■	■	■
0.4	VCGW-110304-FN-0	■	■	■



VCGT
FN-X8

R	Art. N°	PVD					non revêtu unbeschichtet uncoated	
		TiAlN	HTA	TiAlX	HTAX	TiN	K10	K20
		<input type="checkbox"/>	<input type="checkbox"/>	<input type="checkbox"/>	<input type="checkbox"/>	<input type="checkbox"/>	<input type="checkbox"/>	<input type="checkbox"/>
		<input type="checkbox"/>	<input type="checkbox"/>	<input type="checkbox"/>	<input type="checkbox"/>	<input type="checkbox"/>	<input type="checkbox"/>	<input type="checkbox"/>
		<input type="checkbox"/>	<input type="checkbox"/>	<input type="checkbox"/>	<input type="checkbox"/>	<input type="checkbox"/>	<input type="checkbox"/>	<input type="checkbox"/>
		<input type="checkbox"/>	<input type="checkbox"/>	<input type="checkbox"/>	<input type="checkbox"/>	<input type="checkbox"/>	<input type="checkbox"/>	<input type="checkbox"/>
		<input type="checkbox"/>	<input type="checkbox"/>	<input type="checkbox"/>	<input type="checkbox"/>	<input type="checkbox"/>	<input type="checkbox"/>	<input type="checkbox"/>
		<input type="checkbox"/>	<input type="checkbox"/>	<input type="checkbox"/>	<input type="checkbox"/>	<input type="checkbox"/>	<input type="checkbox"/>	<input type="checkbox"/>
		<input type="checkbox"/>	<input type="checkbox"/>	<input type="checkbox"/>	<input type="checkbox"/>	<input type="checkbox"/>	<input type="checkbox"/>	<input type="checkbox"/>
		<input type="checkbox"/>	<input type="checkbox"/>	<input type="checkbox"/>	<input type="checkbox"/>	<input type="checkbox"/>	<input type="checkbox"/>	<input type="checkbox"/>
		<input type="checkbox"/>	<input type="checkbox"/>	<input type="checkbox"/>	<input type="checkbox"/>	<input type="checkbox"/>	<input type="checkbox"/>	<input type="checkbox"/>
		<input type="checkbox"/>	<input type="checkbox"/>	<input type="checkbox"/>	<input type="checkbox"/>	<input type="checkbox"/>	<input type="checkbox"/>	<input type="checkbox"/>
		<input type="checkbox"/>	<input type="checkbox"/>	<input type="checkbox"/>	<input type="checkbox"/>	<input type="checkbox"/>	<input type="checkbox"/>	<input type="checkbox"/>
		<input type="checkbox"/>	<input type="checkbox"/>	<input type="checkbox"/>	<input type="checkbox"/>	<input type="checkbox"/>	<input type="checkbox"/>	<input type="checkbox"/>
		<input type="checkbox"/>	<input type="checkbox"/>	<input type="checkbox"/>	<input type="checkbox"/>	<input type="checkbox"/>	<input type="checkbox"/>	<input type="checkbox"/>
		<input type="checkbox"/>	<input type="checkbox"/>	<input type="checkbox"/>	<input type="checkbox"/>	<input type="checkbox"/>	<input type="checkbox"/>	<input type="checkbox"/>
		<input type="checkbox"/>	<input type="checkbox"/>	<input type="checkbox"/>	<input type="checkbox"/>	<input type="checkbox"/>	<input type="checkbox"/>	<input type="checkbox"/>
		<input type="checkbox"/>	<input type="checkbox"/>	<input type="checkbox"/>	<input type="checkbox"/>	<input type="checkbox"/>	<input type="checkbox"/>	<input type="checkbox"/>
		<input type="checkbox"/>	<input type="checkbox"/>	<input type="checkbox"/>	<input type="checkbox"/>	<input type="checkbox"/>	<input type="checkbox"/>	<input type="checkbox"/>
		<input type="checkbox"/>	<input type="checkbox"/>	<input type="checkbox"/>	<input type="checkbox"/>	<input type="checkbox"/>	<input type="checkbox"/>	<input type="checkbox"/>
		<input type="checkbox"/>	<input type="checkbox"/>	<input type="checkbox"/>	<input type="checkbox"/>	<input type="checkbox"/>	<input type="checkbox"/>	<input type="checkbox"/>
		<input type="checkbox"/>	<input type="checkbox"/>	<input type="checkbox"/>	<input type="checkbox"/>	<input type="checkbox"/>	<input type="checkbox"/>	<input type="checkbox"/>
		<input type="checkbox"/>	<input type="checkbox"/>	<input type="checkbox"/>	<input type="checkbox"/>	<input type="checkbox"/>	<input type="checkbox"/>	<input type="checkbox"/>
		<input type="checkbox"/>	<input type="checkbox"/>	<input type="checkbox"/>	<input type="checkbox"/>	<input type="checkbox"/>	<input type="checkbox"/>	<input type="checkbox"/>
		<input type="checkbox"/>	<input type="checkbox"/>	<input type="checkbox"/>	<input type="checkbox"/>	<input type="checkbox"/>	<input type="checkbox"/>	<input type="checkbox"/>
		<input type="checkbox"/>	<input type="checkbox"/>	<input type="checkbox"/>	<input type="checkbox"/>	<input type="checkbox"/>	<input type="checkbox"/>	<input type="checkbox"/>
		<input type="checkbox"/>	<input type="checkbox"/>	<input type="checkbox"/>	<input type="checkbox"/>	<input type="checkbox"/>	<input type="checkbox"/>	<input type="checkbox"/>
		<input type="checkbox"/>	<input type="checkbox"/>	<input type="checkbox"/>	<input type="checkbox"/>	<input type="checkbox"/>	<input type="checkbox"/>	<input type="checkbox"/>
		<input type="checkbox"/>	<input type="checkbox"/>	<input type="checkbox"/>	<input type="checkbox"/>	<input type="checkbox"/>	<input type="checkbox"/>	<input type="checkbox"/>
		<input type="checkbox"/>	<input type="checkbox"/>	<input type="checkbox"/>	<input type="checkbox"/>	<input type="checkbox"/>	<input type="checkbox"/>	<input type="checkbox"/>
		<input type="checkbox"/>	<input type="checkbox"/>	<input type="checkbox"/>	<input type="checkbox"/>	<input type="checkbox"/>	<input type="checkbox"/>	<input type="checkbox"/>
		<input type="checkbox"/>	<input type="checkbox"/>	<input type="checkbox"/>	<input type="checkbox"/>	<input type="checkbox"/>	<input type="checkbox"/>	<input type="checkbox"/>
		<input type="checkbox"/>	<input type="checkbox"/>	<input type="checkbox"/>	<input type="checkbox"/>	<input type="checkbox"/>	<input type="checkbox"/>	<input type="checkbox"/>
		<input type="checkbox"/>	<input type="checkbox"/>	<input type="checkbox"/>	<input type="checkbox"/>	<input type="checkbox"/>	<input type="checkbox"/>	<input type="checkbox"/>
		<input type="checkbox"/>	<input type="checkbox"/>	<input type="checkbox"/>	<input type="checkbox"/>	<input type="checkbox"/>	<input type="checkbox"/>	<input type="checkbox"/>
		<input type="checkbox"/>	<input type="checkbox"/>	<input type="checkbox"/>	<input type="checkbox"/>	<input type="checkbox"/>	<input type="checkbox"/>	<input type="checkbox"/>
		<input type="checkbox"/>	<input type="checkbox"/>	<input type="checkbox"/>	<input type="checkbox"/>	<input type="checkbox"/>	<input type="checkbox"/>	<input type="checkbox"/>
		<input type="checkbox"/>	<input type="checkbox"/>	<input type="checkbox"/>	<input type="checkbox"/>	<input type="checkbox"/>	<input type="checkbox"/>	<input type="checkbox"/>
		<input type="checkbox"/>	<input type="checkbox"/>	<input type="checkbox"/>	<input type="checkbox"/>	<input type="checkbox"/>	<input type="checkbox"/>	<input type="checkbox"/>
		<input type="checkbox"/>	<input type="checkbox"/>	<input type="checkbox"/>	<input type="checkbox"/>	<input type="checkbox"/>	<input type="checkbox"/>	<input type="checkbox"/>
		<input type="checkbox"/>	<input type="checkbox"/>	<input type="checkbox"/>	<input type="checkbox"/>	<input type="checkbox"/>	<input type="checkbox"/>	<input type="checkbox"/>
		<input type="checkbox"/>	<input type="checkbox"/>	<input type="checkbox"/>	<input type="checkbox"/>	<input type="checkbox"/>	<input type="checkbox"/>	<input type="checkbox"/>
		<input type="checkbox"/>	<input type="checkbox"/>	<input type="checkbox"/>	<input type="checkbox"/>	<input type="checkbox"/>	<input type="checkbox"/>	<input type="checkbox"/>
		<input type="checkbox"/>	<input type="checkbox"/>	<input type="checkbox"/>	<input type="checkbox"/>	<input type="checkbox"/>	<input type="checkbox"/>	<input type="checkbox"/>
		<input type="checkbox"/>	<input type="checkbox"/>	<input type="checkbox"/>	<input type="checkbox"/>	<input type="checkbox"/>	<input type="checkbox"/>	<input type="checkbox"/>
		<input type="checkbox"/>	<input type="checkbox"/>	<input type="checkbox"/>	<input type="checkbox"/>	<input type="checkbox"/>	<input type="checkbox"/>	<input type="checkbox"/>
		<input type="checkbox"/>	<input type="checkbox"/>	<input type="checkbox"/>	<input type="checkbox"/>	<input type="checkbox"/>	<input type="checkbox"/>	<input type="checkbox"/>
		<input type="checkbox"/>	<input type="checkbox"/>	<input type="checkbox"/>	<input type="checkbox"/>	<input type="checkbox"/>	<input type="checkbox"/>	<input type="checkbox"/>
		<input type="checkbox"/>	<input type="checkbox"/>	<input type="checkbox"/>	<input type="checkbox"/>	<input type="checkbox"/>	<input type="checkbox"/>	<input type="checkbox"/>
		<input type="checkbox"/>	<input type="checkbox"/>	<input type="checkbox"/>	<input type="checkbox"/>	<input type="checkbox"/>	<input type="checkbox"/>	<input type="checkbox"/>
		<input type="checkbox"/>	<input type="checkbox"/>	<input type="checkbox"/>	<input type="checkbox"/>	<input type="checkbox"/>	<input type="checkbox"/>	<input type="checkbox"/>
		<input type="checkbox"/>	<input type="checkbox"/>	<input type="checkbox"/>	<input type="checkbox"/>	<input type="checkbox"/>	<input type="checkbox"/>	<input type="checkbox"/>
		<input type="checkbox"/>	<input type="checkbox"/>	<input type="checkbox"/>	<input type="checkbox"/>	<input type="checkbox"/>	<input type="checkbox"/>	<input type="checkbox"/>
		<input type="checkbox"/>	<input type="checkbox"/>	<input type="checkbox"/>	<input type="checkbox"/>	<input type="checkbox"/>	<input type="checkbox"/>	<input type="checkbox"/>
		<input type="checkbox"/>	<input type="checkbox"/>	<input type="checkbox"/>	<input type="checkbox"/>	<input type="checkbox"/>	<input type="checkbox"/>	<input type="checkbox"/>
		<input type="checkbox"/>	<input type="checkbox"/>	<input type="checkbox"/>	<input type="checkbox"/>	<input type="checkbox"/>	<input type="checkbox"/>	<input type="checkbox"/>
		<input type="checkbox"/>	<input type="checkbox"/>	<input type="checkbox"/>	<input type="checkbox"/>	<input type="checkbox"/>	<input type="checkbox"/>	<input type="checkbox"/>
		<input type="checkbox"/>	<input type="checkbox"/>	<input type="checkbox"/>	<input type="checkbox"/>	<input type="checkbox"/>	<input type="checkbox"/>	<input type="checkbox"/>
		<input type="checkbox"/>	<input type="checkbox"/>	<input type="checkbox"/>	<input type="checkbox"/>	<input type="checkbox"/>	<input type="checkbox"/>	<input type="checkbox"/>
		<input type="checkbox"/>	<input type="checkbox"/>	<input type="checkbox"/>	<input type="checkbox"/>	<input type="checkbox"/>	<input type="checkbox"/>	<input type="checkbox"/>
		<input type="checkbox"/>	<input type="checkbox"/>	<input type="checkbox"/>	<input type="checkbox"/>	<input type="checkbox"/>	<input type="checkbox"/>	<input type="checkbox"/>
		<input type="checkbox"/>	<input type="checkbox"/>	<input type="checkbox"/>	<input type="checkbox"/>	<input type="checkbox"/>	<input type="checkbox"/>	<input type="checkbox"/>
		<input type="checkbox"/>	<input type="checkbox"/>	<input type="checkbox"/>	<input type="checkbox"/>	<input type="checkbox"/>	<input type="checkbox"/>	<input type="checkbox"/>
		<input type="checkbox"/>	<input type="checkbox"/>	<input type="checkbox"/>	<input type="checkbox"/>	<input type="checkbox"/>	<input type="checkbox"/>	<input type="checkbox"/>
		<input type="checkbox"/>	<input type="checkbox"/>	<input type="checkbox"/>	<input type="checkbox"/>	<input type="checkbox"/>	<input type="checkbox"/>	<input type="checkbox"/>
		<input type="checkbox"/>	<input type="checkbox"/>	<input type="checkbox"/>	<input type="checkbox"/>	<input type="checkbox"/>	<input type="checkbox"/>	<input type="checkbox"/>
		<input type="checkbox"/>	<input type="checkbox"/>	<input type="checkbox"/>	<input type="checkbox"/>	<input type="checkbox"/>	<input type="checkbox"/>	<input type="checkbox"/>
		<input type="checkbox"/>	<input type="checkbox"/>	<input type="checkbox"/>	<input type="checkbox"/>	<input type="checkbox"/>	<input type="checkbox"/>	<input type="checkbox"/>
		<input type="checkbox"/>	<input type="checkbox"/>	<input type="checkbox"/>	<input type="checkbox"/>	<input type="checkbox"/>	<input type="checkbox"/>	<input type="checkbox"/>
		<input type="checkbox"/>	<input type="checkbox"/>	<input type="checkbox"/>	<input type="checkbox"/>	<input type="checkbox"/>	<input type="checkbox"/>	<input type="checkbox"/>
		<input type="checkbox"/>	<input type="checkbox"/>	<input type="checkbox"/>	<input type="checkbox"/>	<input type="checkbox"/>	<input type="checkbox"/>	<input type="checkbox"/>
		<input type="checkbox"/>	<input type="checkbox"/>	<input type="checkbox"/>	<input type="checkbox"/>	<input type="checkbox"/>	<input type="checkbox"/>	<input type="checkbox"/>
		<input type="checkbox"/>	<input type="checkbox"/>	<input type="checkbox"/>	<input type="checkbox"/>	<input type="checkbox"/>	<input type="checkbox"/>	<input type="checkbox"/>
		<input type="checkbox"/>	<input type="checkbox"/>	<input type="checkbox"/>	<input type="checkbox"/>	<input type="checkbox"/>	<input type="checkbox"/>	<input type="checkbox"/>
		<input type="checkbox"/>	<input type="checkbox"/>	<input type="checkbox"/>	<input type="checkbox"/>	<input type="checkbox"/>	<input type="checkbox"/>	<input type="checkbox"/>
		<input type="checkbox"/>	<input type="checkbox"/>	<input type="checkbox"/>	<input type="checkbox"/>	<input type="checkbox"/>	<input type="checkbox"/>	<input type="checkbox"/>
		<input type="checkbox"/>	<input type="checkbox"/>	<input type="checkbox"/>	<input type="checkbox"/>	<input type="checkbox"/>	<input type="checkbox"/>	<input type="checkbox"/>
		<input type="checkbox"/>	<input type="checkbox"/>	<input type="checkbox"/>	<input type="checkbox"/>	<input type="checkbox"/>	<input type="checkbox"/>	<input type="checkbox"/>
		<input type="checkbox"/>	<input type="checkbox"/>	<input type="checkbox"/>	<input type="checkbox"/>	<input type="checkbox"/>	<input type="checkbox"/>	<input type="checkbox"/>
		<input type="checkbox"/>	<input type="checkbox"/>	<input type="checkbox"/>	<input type="checkbox"/>	<input type="checkbox"/>	<input type="checkbox"/>	<input type="checkbox"/>
		<input type="checkbox"/>	<input type="checkbox"/>	<input type="checkbox"/>	<input type="checkbox"/>	<input type="checkbox"/>	<input type="checkbox"/>	<input type="checkbox"/>
		<input type="checkbox"/>	<input type="checkbox"/>	<input type="checkbox"/>	<input type="checkbox"/>	<input type="checkbox"/>	<input type="checkbox"/>	<input type="checkbox"/>
		<input type="checkbox"/>	<input type="checkbox"/>	<input type="checkbox"/>	<input type="checkbox"/>	<input type="checkbox"/>	<input type="checkbox"/>	<input type="checkbox"/>
		<input type="checkbox"/>	<input type="checkbox"/>	<input type="checkbox"/>	<input type="checkbox"/>	<input type="checkbox"/>	<input type="checkbox"/>	<input type="checkbox"/>
		<input type="checkbox"/>	<input type="checkbox"/>	<input type="checkbox"/>	<input type="checkbox"/>	<input type="checkbox"/>	<input type="checkbox"/>	<input type="checkbox"/>
		<input type="checkbox"/>	<input type="checkbox"/>	<input type="checkbox"/>	<input type="checkbox"/>	<input type="checkbox"/>	<input type="checkbox"/>	<input type="checkbox"/>
		<input type="checkbox"/>	<input type="checkbox"/>	<input type="checkbox"/>	<input type="checkbox"/>	<input type="checkbox"/>	<input type="checkbox"/>	<input type="checkbox"/>
		<input type="checkbox"/>	<input type="checkbox"/>	<input type="checkbox"/>	<input type="checkbox"/>	<input type="checkbox"/>	<input type="checkbox"/>	<input type="checkbox"/>
		<input type="checkbox"/>	<input type="checkbox"/>	<input type="checkbox"/>	<input type="checkbox"/>	<input type="checkbox"/>	<input type="checkbox"/>	<input type="checkbox"/>
		<input type="checkbox"/>	<input type="checkbox"/>	<input type="checkbox"/>	<input type="checkbox"/>	<input type="checkbox"/>	<input type="checkbox"/>	<input type="checkbox"/>
		<input type="checkbox"/>	<input type="checkbox"/>	<input type="checkbox"/>	<input type="checkbox"/>	<input type="checkbox"/>	<input type="checkbox"/>	<input type="checkbox"/>
		<input type="checkbox"/>	<input type="checkbox"/>	<input type="checkbox"/>	<input type="checkbox"/>	<input type="checkbox"/>	<input type="checkbox"/>	<input type="checkbox"/>
		<input type="checkbox"/>	<input type="checkbox"/>	<input type="checkbox"/>	<input type="checkbox"/>	<input type="checkbox"/>	<input type="checkbox"/>	<input type="checkbox"/>
		<input type="checkbox"/>	<input type="checkbox"/>	<input type="checkbox"/>	<input type="checkbox"/>	<input type="checkbox"/>	<input type="checkbox"/>	<input type="checkbox"/>
		<input type="checkbox"/>	<input type="checkbox"/>	<input type="checkbox"/>	<input type="checkbox"/>	<input type="checkbox"/>	<input type="checkbox"/>	<input type="checkbox"/>
		<input type="checkbox"/>	<input type="checkbox"/>	<input type="checkbox"/>	<input type="checkbox"/>	<input type="checkbox"/>	<input type="checkbox"/>	<input type="checkbox"/>
		<input type="checkbox"/>	<input type="checkbox"/>	<input type="checkbox"/>	<input type="checkbox"/>	<input type="checkbox"/>	<input type="checkbox"/>	<input type="checkbox"/>
		<input type="checkbox"/>	<input type="checkbox"/>	<input type="checkbox"/>	<input type="checkbox"/>	<input type="checkbox"/>	<input type="checkbox"/>	<input type="checkbox"/>
		<input type="checkbox"/>	<input type="checkbox"/>	<input type="checkbox"/>	<input type="checkbox"/>	<input type="checkbox"/>	<input type="checkbox"/>	<input type="checkbox"/>
		<input type="checkbox"/>	<input type="checkbox"/>	<input type="checkbox"/>	<input type="checkbox"/>	<input type="checkbox"/>	<input type="checkbox"/>	<input type="checkbox"/>
		<input type="checkbox"/>	<input type="checkbox"/>	<input type="checkbox"/>	<input type="checkbox"/>	<input type="checkbox"/>	<input type="checkbox"/>	<input type="checkbox"/>
		<input type="checkbox"/>	<input type="checkbox"/>	<input type="checkbox"/>	<input type="checkbox"/>	<input type="checkbox"/>	<input type="checkbox"/>	<input type="checkbox"/>
		<input type="checkbox"/>	<input type="checkbox"/>	<input type="checkbox"/>	<input type="checkbox"/>	<input type="checkbox"/>	<input type="checkbox"/>	<input type="checkbox"/>
		<input type="checkbox"/>	<input type="checkbox"/>	<input type="checkbox"/>	<input type="checkbox"/>	<input type="checkbox"/>	<input type="checkbox"/>	<input type="checkbox"/>
		<input type="checkbox"/>	<input type="checkbox"/>	<input type="checkbox"/>	<input type="checkbox"/>	<input type="checkbox"/>	<input type="checkbox"/>	<input type="checkbox"/>
		<input type="checkbox"/>	<input type="checkbox"/>	<input type="checkbox"/>	<input type="checkbox"/>	<input type="checkbox"/>	<input type="checkbox"/>	<input type="checkbox"/>
		<input type="checkbox"/>	<input type="checkbox"/>	<input type="checkbox"/>	<input type="checkbox"/>	<input type="checkbox"/>	<input type="checkbox"/>	<input type="checkbox"/>
		<input type="checkbox"/>	<input type="checkbox"/>	<input type="checkbox"/>	<input type="checkbox"/>	<input type="checkbox"/>	<input type="checkbox"/>	<input type="checkbox"/>
		<input type="checkbox"/>	<input type="checkbox"/>	<input type="checkbox"/>	<input type="checkbox"/>	<input type="checkbox"/>	<input type="checkbox"/>	<input type="checkbox"/>
		<input type="checkbox"/>	<input type="checkbox"/>	<input type="checkbox"/>	<input type="checkbox"/>	<input type="checkbox"/>	<input type="checkbox"/>	<input type="checkbox"/>
		<input type="checkbox"/>	<input type="checkbox"/>	<input type="checkbox"/>	<input type="checkbox"/>	<input type="checkbox"/>	<input type="checkbox"/>	<input type="checkbox"/>
		<input type="checkbox"/>	<input type="checkbox"/>	<input type="checkbox"/>	<input type="checkbox"/>	<input type="checkbox"/>	<input type="checkbox"/>	<input type="checkbox"/>
		<input type="checkbox"/>	<input type="checkbox"/>	<input type="checkbox"/>	<input type="checkbox"/>	<input type="checkbox"/>	<input type="checkbox"/>	<input type="checkbox"/>
		<input type="checkbox"/>	<input type="checkbox"/>	<input type="checkbox"/>	<input type="checkbox"/>	<input type="checkbox"/>	<input type="checkbox"/>	<input type="checkbox"/>
		<input type="checkbox"/>	<input type="checkbox"/>	<input type="checkbox"/>	<input type="checkbox"/>	<input type="checkbox"/>	<input type="checkbox"/>	<input type="checkbox"/>
		<input type="checkbox"/>	<input type="checkbox"/>	<input type="checkbox"/>	<input type="checkbox"/>	<input type="checkbox"/>	<input type="checkbox"/>	<input type="checkbox"/>
		<input type="checkbox"/>	<input type="checkbox"/>	<input type="checkbox"/>	<input type="checkbox"/>	<input type="checkbox"/>	<input type="checkbox"/>	<input type="checkbox"/>
		<input type="checkbox"/>	<input type="checkbox"/>	<input type="checkbox"/>	<input type="checkbox"/>	<input type="checkbox"/>	<input type="checkbox"/>	<input type="checkbox"/>
		<input type="checkbox"/>	<input type="checkbox"/>	<input type="checkbox"/>	<input type="checkbox"/>	<input type="checkbox"/>	<input type="checkbox"/>	<input type="checkbox"/>
		<input type="checkbox"/>	<input type="checkbox"/>	<input type="checkbox"/>	<input type="checkbox"/>	<input type="checkbox"/>	<input type="checkbox"/>	<input type="checkbox"/>
		<input type="checkbox"/>	<input type="checkbox"/>	<input type="checkbox"/>	<input type="checkbox"/>	<input type="checkbox"/>	<input type="checkbox"/>	<input type="checkbox"/>
		<input type="checkbox"/>	<input type="checkbox"/>	<input type="checkbox"/>	<input type="checkbox"/>	<input type="checkbox"/>	<input type="checkbox"/>	<input type="checkbox"/>
		<input type="checkbox"/>	<input type="checkbox"/>	<input type="checkbox"/>	<input type="checkbox"/>	<input type="checkbox"/>	<input type="checkbox"/>	<input type="checkbox"/>
		<input type="checkbox"/>	<input type="checkbox"/>	<input type="checkbox"/>	<input type="checkbox"/>	<input type="checkbox"/>	<input type="checkbox"/>	<input type="checkbox"/>
		<input type="checkbox"/>	<input type="checkbox"/>	<input type="checkbox"/>	<input type="checkbox"/>	<input type="checkbox"/>	<input type="checkbox"/>	<input type="checkbox"/>
		<input type="checkbox"/>	<input type="checkbox"/>	<input type="checkbox"/>	<input type="checkbox"/>	<input type="checkbox"/>	<input type="checkbox"/>	<input type="checkbox"/>
		<input type="checkbox"/>	<input type="checkbox"/>	<input type="checkbox"/>	<input type="checkbox"/>	<input type="checkbox"/>	<input type="checkbox"/>	<input type="checkbox"/>
		<input type="checkbox"/>	<input type="checkbox"/>	<input type="checkbox"/>	<input type="checkbox"/>	<input type="checkbox"/>	<input type="checkbox"/>	<input type="checkbox"/>
		<input type="checkbox"/>	<input type="checkbox"/>	<input type="checkbox"/>	<input type="checkbox"/>	<input type="checkbox"/>	<input type="checkbox"/>	<input type="checkbox"/>
		<input type="checkbox"/>	<input type="checkbox"/>	<input type="checkbox"/>	<input type="checkbox"/>	<input type="checkbox"/>	<input type="checkbox"/>	<input type="checkbox"/>
		<input type="checkbox"/>	<input type="checkbox"/>	<input type="checkbox"/>	<input type="checkbox"/>	<input type="checkbox"/>	<input type="checkbox"/>	<input type="checkbox"/>
		<input type="checkbox"/>	<input type="checkbox"/>	<input type="checkbox"/>	<input type="checkbox"/>	<input type="checkbox"/>	<input type="checkbox"/>	<input type="checkbox"/>
		<input type="checkbox"/>	<input type="checkbox"/>	<input type="checkbox"/>	<input type="checkbox"/>	<input type="checkbox"/>	<input type="checkbox"/>	<input type="checkbox"/>
		<input type="checkbox"/>	<input type="checkbox"/>	<input type="checkbox"/>	<input type="checkbox"/>	<input type="checkbox"/>	<input type="checkbox"/>	<input type="checkbox"/>
		<input type="checkbox"/>	<input type="checkbox"/>	<input type="checkbox"/>	<input type="checkbox"/>	<input type="checkbox"/>	<input type="checkbox"/>	<input type="checkbox"/>
		<input type="checkbox"/>	<input type="checkbox"/>	<input type="checkbox"/>	<input type="checkbox"/>	<input type="checkbox"/>	<input type="checkbox"/>	<input type="checkbox"/>
		<input type="checkbox"/>	<input type="checkbox"/>	<input type="checkbox"/>	<input type="checkbox"/>	<input type="checkbox"/>	<input type="checkbox"/>	<input type="checkbox"/>
		<input type="checkbox"/>	<input type="checkbox"/>	<input type="checkbox"/>	<input type="checkbox"/>	<input type="checkbox"/>	<input type="checkbox"/>	<input type="checkbox"/>
		<input type="checkbox"/>	<input type="checkbox"/>	<input type="checkbox"/>	<input type="checkbox"/>	<input type="checkbox"/>	<input type="checkbox"/>	<input type="checkbox"/>
		<input type="checkbox"/>	<input type="checkbox"/>	<input type="checkbox"/>	<input type="checkbox"/>	<input type="checkbox"/>	<input type="checkbox"/>	<input type="checkbox"/>
		<input type="checkbox"/>	<input type="checkbox"/>	<input type="checkbox"/>	<input type="checkbox"/>	<input type="checkbox"/>	<input type="checkbox"/>	<input type="checkbox"/>
		<input type="checkbox"/>	<input type="checkbox"/>	<input type="checkbox"/>	<input type="checkbox"/>	<input type="checkbox"/>	<input type="checkbox"/>	<input type="checkbox"/>
		<input type="checkbox"/>	<input type="checkbox"/>	<input type="checkbox"/>	<input type="checkbox"/>	<input type="checkbox"/>	<input type="checkbox"/>	<input type="checkbox"/>
		<input type="checkbox"/>	<input type="checkbox"/>	<input type="checkbox"/>	<input type="checkbox"/>	<input type="checkbox"/>	<input type="checkbox"/>	<input type="checkbox"/>
		<input type="checkbox"/>	<input type="checkbox"/>	<input type="checkbox"/>	<input type="checkbox"/>	<input type="checkbox"/>	<input type="checkbox"/>	<input type="checkbox"/>
		<input type="checkbox"/>	<input type="checkbox"/>	<input type="checkbox"/>	<input type="checkbox"/>	<input type="checkbox"/>	<input type="checkbox"/>	<input type="checkbox"/>
		<input type="checkbox"/>	<input type="checkbox"/>	<input type="checkbox"/>	<input type="checkbox"/>	<input type="checkbox"/>	<input type="checkbox"/>	<input type="checkbox"/>

Plaquettes en métal dur

VHM-Wendeplatten

Solid carbide inserts

35°

VCGT-X20



VCGT
ENP-X20

PVD	
<input type="checkbox"/>	<input type="checkbox"/>
<input checked="" type="checkbox"/> M	<input checked="" type="checkbox"/> M
<input checked="" type="checkbox"/> N	<input checked="" type="checkbox"/> N
<input checked="" type="checkbox"/> S	<input checked="" type="checkbox"/> S
ZTA	HTIX

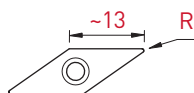

R	H	Art. N°	ZTA	HTIX
0.2	0.25	VCGT-130302-ENP-X20	■	■
0.4	0.25	VCGT-130304-ENP-X20	■	■
0.8	0.25	VCGT-130308-ENP-X20	■	■

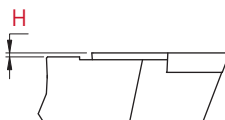

ISO-LINE

Plaquettes en métal dur
 VHM-Wendeplatten
 Solid carbide inserts

35°

VCMT-XF3
 VCMT-XF2



**VCMT
 EN-XF3**

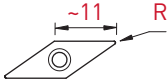

R	Art. N°	PVD	
		TAC	HTAC
0.2	VCMT-110302-EN-XF3	■	■
0.4	VCMT-110304-EN-XF3	■	■

PVD	
P	P
M	M
N	N
S	S
TAC	HTAC



**VCMT
 EN-XF2**

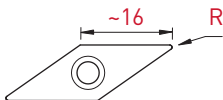
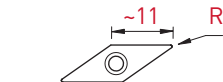

R	Art. N°	PVD		CVD
		TAC	HTAC	HTi5
0.2	VCMT-110302-EN-XF2	■	■	■
0.4	VCMT-110304-EN-XF2	■	■	■
0.4	VCMT-160404-EN-XF2	■	■	■

PVD		CVD
P	P	P
M	M	M
N	N	
S	S	
TAC	HTAC	HTi5



VCGT
FN-X8

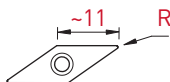









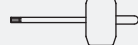

R	Art. N°	CERMET	
		PVD	non revêtu unbeschichtet uncoated
		<input checked="" type="checkbox"/> P <input checked="" type="checkbox"/> M <input type="checkbox"/> <input type="checkbox"/>	<input checked="" type="checkbox"/> P <input type="checkbox"/> <input type="checkbox"/> <input type="checkbox"/>
		CTA	CN6
0.05	VCGT-1103005-FN-X8	<input checked="" type="checkbox"/>	<input checked="" type="checkbox"/>
0.1	VCGT-110301-FN-X8	<input checked="" type="checkbox"/>	<input checked="" type="checkbox"/>
0.2	VCGT-110302-FN-X8	<input checked="" type="checkbox"/>	<input checked="" type="checkbox"/>
0.4	VCGT-110304-FN-X8	<input checked="" type="checkbox"/>	<input checked="" type="checkbox"/>

Pièces de rechange et accessoires

Ersatzteile und Zubehör

Spare parts and accessories

Vis et clés de rechange Ersatzschrauben und Schlüssel Spare screws and keys	Porte-outils Halter Holders	Vis Schrauben Screw	Clé Schlüssel Key		
				Option	Serrage Drehmoment Torque
	Series SC...-06 Series SD...-07 Series SV...-11	V-M2.5X7.8-T8 	C-T8 	SET-NM-TX8	1.3 Nm
	Series SV...-13	V-M3X7.3-T8-ISO 			2.0 Nm
	Series SC...-09 Series SD...-11 Series SV...-16	V-M4X9-T15-ISO 	C-T15 	SET-NM-TX15	3.0 Nm

Pièces de rechange JET Ersatzteile JET Spare parts JET	L Pour réf. For ref. Für Ref	 *	 *	 *
		Art. N°	Art. N°	Art. N°
	S...L-10...-JET	JJL-4X12-D1.5		
	S...L-12...-JET S...L-12.7...-JET	JJL-4X14-D1.5	J-M8X1-D6	JB-M8X1
	S...L-16...-JET S...L-20...-JET	JJL-4X17-D1.5		
	R Pour réf. For ref. Für Ref	 *	 *	 *
		Art. N°	Art. N°	Art. N°
	S...R-10...-JET	JJR-4X12-D1.5		
	S...R-12...-JET S...R-12.7...-JET	JJR-4X14-D1.5	J-M8X1-D6	JB-M8X1
	S...R-16...-JET S...R-20...-JET	JJR-4X17-D1.5		

* livré avec chaque porte-outil
mit jedem Halter geliefert
delivered with each holder

ISO-Line	Tough grade, for normal to difficult machining conditions	Wear resistant grade, for finishing and light machining	Acier Stahl Steel						Inox Rostfreistahl Stainless steel			
			Acier de décolletage Automatenstahl Free-cutting steel		Acier faiblement allié Leicht legierter Stahl Low alloyed steel		Acier fortement allié Hochlegierter Stahl High alloyed steel		Austénitique Austenitisch Austenitic		Martensitique Martensitisch Martensitic	
			VC (m/min)	F (mm/U)	VC (m/min)	F (mm/U)	VC (m/min)	F (mm/U)	VC (m/min)	F (mm/U)	VC (m/min)	F (mm/U)
FN-X8	TiAlN	HTA	80-180	0.01-0.12	60-150	0.01-0.10	50-120	0.01-0.08	60-140	0.01-0.12	60-140	0.01-0.12
	TiAlX	HTAX	80-180	0.01-0.12	60-150	0.01-0.10	50-120	0.01-0.08	60-140	0.01-0.12	60-140	0.01-0.12
	TiN		80-170	0.01-0.12	60-140	0.01-0.10			60-120	0.01-0.12	60-120	0.01-0.12
	N	HN										
ENP-X8	TiAlN	HTA	80-180	0.03-0.15	60-160	0.03-0.12	50-120	0.03-0.10	60-140	0.03-0.12	60-140	0.03-0.15
	TiN		80-170	0.03-0.15	60-150	0.03-0.12			60-120	0.03-0.12	60-120	0.03-0.15
	N	HN										
FN-X17	TiAlN	HTA	80-180	0.01-0.12	60-150	0.01-0.10			60-140	0.01-0.15	60-140	0.01-0.15
	TiAlX	HTAX	80-180	0.01-0.12	60-150	0.01-0.10	50-120	0.01-0.08	60-140	0.01-0.12	60-140	0.01-0.12
	TiN		80-170	0.01-0.12					60-120	0.01-0.15	60-120	0.01-0.15
	N	HN										
ENP-X17	TiAlN	HTA	80-180	0.03-0.15	60-160	0.03-0.12	50-120	0.03-0.10	60-140	0.03-0.15	60-140	0.03-0.18
	TiAlX	HTAX	80-180	0.01-0.12	60-150	0.01-0.10	50-120	0.01-0.08	60-140	0.01-0.12	60-140	0.01-0.12
	TiN		80-170	0.03-0.15	60-150	0.03-0.12			60-120	0.01-0.15	60-120	0.03-0.18
	N	HN										
FN-X25	TiAlN	HTA							60-140	0.01-0.12		
	TiN								60-120	0.01-0.12		
	N	HN										
ENP-X25	TiAlN	HTA							60-140	0.03-0.12	60-140	0.03-0.15
	TiAlX		80-180	0.01-0.12	60-150	0.01-0.10	50-120	0.01-0.08	60-140	0.01-0.12	60-140	0.01-0.12
	TiN								60-120	0.03-0.12	60-120	0.03-0.15
	N	HN										
ENP-X20	ZTA								60-140	0.03-0.18	60-140	0.03-0.18
	HTiX								60-140	0.03-0.18	60-140	0.03-0.18

G tolerance class		Special 35° VC...11										
FL / FR-X10	TiAlN	HTA	80-180	0.01-0.12	60-150	0.01-0.10	50-120	0.01-0.08	60-140	0.01-0.12	60-140	0.01-0.12
	TiAlX	HTAX	80-180	0.01-0.12	60-150	0.01-0.10	50-120	0.01-0.08	60-140	0.01-0.12	60-140	0.01-0.12
	TiN		80-170	0.01-0.12	60-140	0.01-0.10			60-120	0.01-0.12	60-120	0.01-0.12
	N	HN										
ELP/ERP-X10	TiAlN	HTA	80-180	0.03-0.15	60-160	0.03-0.12	50-120	0.03-0.10	60-140	0.03-0.12	60-140	0.03-0.15
	TiAlX	HTAX	80-180	0.03-0.15	60-160	0.03-0.12	50-120	0.03-0.10	60-140	0.03-0.12	60-140	0.03-0.15
	TiN		80-170	0.03-0.15	60-150	0.03-0.12			60-120	0.03-0.12	60-120	0.03-0.15
	N	HN										
FN-K18		HTA	80-180	0.01-0.10	60-150	0.01-0.10			60-140	0.01-0.10	60-140	0.01-0.10
		HTiN	80-170	0.01-0.10	60-140	0.01-0.10			60-120	0.01-0.10	60-120	0.01-0.10
		HN										
FN-0		HTA	80-150	0.01-0.10								
		HTiN	80-140	0.01-0.10								
		HN										



N Alliage d'aluminium et non ferreux
Aluminium- und Nichteisenlegierungen
Aluminium and non-ferrous alloys

S Titane et superalliages
Titan und Superlegierungen
Titanium and superalloys

Aluminium		Al-Si		Cuivre Kupfer Copper		Laiton & bronze Messing & Bronze Brass & bronze		Ti grade 1 - 3		Ti grade 4 - 6		Superalliages Superlegierungen Superalloys	
VC (m/min)	F (mm/U)	VC (m/min)	F (mm/U)	VC (m/min)	F (mm/U)	VC (m/min)	F (mm/U)	VC (m/min)	F (mm/U)	VC (m/min)	F (mm/U)	VC (m/min)	F (mm/U)
		150-1600	0.01-0.15	80-300	0.01-0.12	100-400	0.01-0.15			30-60	0.01-0.12	40-70	0.01-0.10
								30-70	0.01-0.12	30-60	0.01-0.12	40-70	0.01-0.10
120-2200	0.01-0.18	150-1600	0.01-0.15	80-300	0.01-0.12	100-400	0.01-0.15						
120-2000	0.01-0.18	150-1500	0.01-0.15	80-250	0.01-0.12	100-300	0.01-0.15	30-70	0.01-0.12				
		150-800	0.03-0.18	80-300	0.03-0.15					30-60	0.03-0.12	40-70	0.03-0.10
		150-800	0.03-0.18	80-300	0.03-0.15								
		150-800	0.03-0.18	80-250	0.03-0.15								
		150-1600	0.01-0.18	80-300	0.01-0.15	100-400	0.01-0.18			30-70	0.01-0.15	40-80	0.01-0.12
								30-70	0.01-0.12	30-60	0.01-0.12	40-70	0.01-0.10
120-2200	0.01-0.25	150-1600	0.01-0.18	80-300	0.01-0.15	100-400	0.01-0.18						
120-2000	0.01-0.25	150-1500	0.01-0.18	80-250	0.01-0.15	100-300	0.01-0.18	40-80	0.01-0.15				
		150-800	0.03-0.20	80-300	0.03-0.18					30-70	0.03-0.15	40-80	0.03-0.12
								30-70	0.01-0.12	30-60	0.01-0.12	40-70	0.01-0.10
		150-800	0.03-0.20	80-300	0.03-0.18								
		150-800	0.03-0.20	80-250	0.03-0.18								
		150-1600	0.01-0.22	80-300	0.01-0.18					30-60	0.01-0.12	40-70	0.01-0.10
120-2200	0.01-0.30	150-1600	0.01-0.22	80-300	0.01-0.18								
120-2000	0.01-0.30	150-1500	0.01-0.22	80-250	0.01-0.18			30-70	0.01-0.12				
		150-800	0.03-0.25	80-300	0.03-0.20					30-60	0.03-0.12	40-70	0.03-0.10
								30-70	0.01-0.12	30-60	0.01-0.12	40-70	0.01-0.10
		150-800	0.03-0.25	80-300	0.03-0.20								
		150-800	0.03-0.25	80-250	0.03-0.20								
		150-800	0.03-0.25	80-300	0.03-0.20					40-90	0.03-0.15	40-100	0.03-0.15
		150-800	0.03-0.25	80-300	0.03-0.20					40-80	0.03-0.15	40-90	0.03-0.15

		150-1600	0.01-0.18	80-300	0.01-0.15	100-400	0.01-0.18			30-60	0.01-0.12	40-70	0.01-0.10
								30-70	0.01-0.12	30-60	0.01-0.12	40-70	0.01-0.10
120-2200	0.01-0.20	150-1600	0.01-0.18	80-300	0.01-0.15	100-400	0.01-0.18						
120-2000	0.01-0.20	150-1500	0.01-0.18	80-250	0.01-0.15	100-300	0.01-0.18	30-70	0.01-0.12				
		150-1600	0.03-0.20	80-300	0.03-0.18					30-60	0.03-0.12	40-70	0.03-0.10
										30-60	0.03-0.12	40-70	0.03-0.10
		150-1600	0.03-0.20	80-300	0.01-0.18								
		150-1500	0.03-0.20	80-250	0.01-0.18								
		150-1600	0.01-0.12	80-300	0.01-0.10					30-70	0.01-0.10	40-80	0.01-0.10
120-2200	0.01-0.15	150-1600	0.01-0.12	80-300	0.01-0.10								
120-2000	0.01-0.15	150-1500	0.01-0.12	80-250	0.01-0.10			40-80	0.01-0.10				
						100-400	0.01-0.18						
						100-400	0.01-0.18						
						100-300	0.01-0.18						

Paramètres de coupe indicatifs

Empfohlene Schnittwerte

Standard machining data

ISO-Line M tolerance class	Tough grade, for normal to difficult machining conditions	Wear resistant grade, for finishing and light machining	Acier Stahl Steel						Inox Rostfreistahl Stainless steel			
			Acier de décolletage Automatenstahl Free-cutting steel		Acier faiblement allié Leicht legierter Stahl Low alloyed steel		Acier fortement allié Hochlegierter Stahl High alloyed steel		Austénitique Austenitisch Austenitic		Martensitique Martensitisch Martensitic	
			VC (m/min)	F (mm/U)	VC (m/min)	F (mm/U)	VC (m/min)	F (mm/U)	VC (m/min)	F (mm/U)	VC (m/min)	F (mm/U)
EN-XF3	TAC	HTAC	100-200	0.03-0.15	80-160	0.03-0.12	50-120	0.03-0.10	60-140	0.03-0.12	60-140	0.03-0.15
EN-XF2	TAC	HTAC	100-200	0.03-0.15	80-160	0.03-0.12	50-120	0.03-0.10	60-140	0.03-0.12	60-140	0.03-0.15
		HTi5	100-250	0.03-0.15	80-220	0.03-0.12	50-180	0.03-0.10	80-200	0.03-0.12	80-200	0.03-0.15
EN-MF2	TAC	HTAC	100-200	0.04-0.15	80-160	0.04-0.12	50-120	0.04-0.10	60-140	0.04-0.12	60-140	0.04-0.15
		HTi5	100-250	0.04-0.15	80-220	0.04-0.12	50-180	0.04-0.10	80-200	0.04-0.12	80-200	0.04-0.15
EN-MF	Tmax		100-220	0.04-0.30	80-180	0.04-0.25	50-150	0.04-0.20	60-150	0.04-0.25	60-150	0.04-0.25
		Ti4	100-250	0.05-0.30	80-220	0.05-0.25	50-180	0.05-0.20	80-200	0.05-0.25	80-200	0.05-0.25
EN-HF3	TiX	HTiX	100-220	0.06-0.35	80-180	0.06-0.30	50-150	0.06-0.25	60-150	0.06-0.25	60-150	0.06-0.25
		Ti6	100-250	0.06-0.35	80-220	0.06-0.30	50-180	0.06-0.25	80-200	0.06-0.25	80-200	0.06-0.25
EN-HF	Tmax		100-220	0.08-0.40	80-180	0.08-0.35	50-150	0.08-0.30	60-150	0.08-0.30	60-150	0.08-0.30
		TAC	100-200	0.08-0.40	80-160	0.08-0.35	50-140	0.08-0.30	60-140	0.08-0.30	60-140	0.08-0.30
		Ti4	100-250	0.08-0.40	80-220	0.08-0.35	50-180	0.08-0.30	80-200	0.08-0.30	80-200	0.08-0.30
		Ti5	HTi5	100-280	0.08-0.40	80-250	0.08-0.35	50-200	0.08-0.30	80-220	0.08-0.30	80-220

ISO-Line CERMET												
FN-X8 CERMET	CTA		100-350	0.01-0.12	80-300	0.01-0.10	70-250	0.01-0.08	80-250	0.01-0.12	80-250	0.01-0.12
		CN6	100-300	0.01-0.12	80-250	0.01-0.10	70-200	0.01-0.08				
ENP-KX CERMET	CT7	HCT7	100-350	0.03-0.20	80-300	0.03-0.18	70-250	0.03-0.15	80-250	0.03-0.18	80-250	0.03-0.18
		CN6	100-300	0.03-0.20	80-250	0.03-0.18	70-200	0.03-0.15				
EN-KM CERMET	CT7	HCT7	100-350	0.03-0.25	80-300	0.03-0.20	70-250	0.03-0.18	80-250	0.03-0.20	80-250	0.03-0.20
		CN6	100-300	0.03-0.25	80-250	0.03-0.20	70-200	0.03-0.18				



N Alliages d'aluminium et non ferreux Aluminium- und Nichteisenlegierungen Aluminium and non-ferrous alloys								S Titane et superalliages Titan und Superlegierungen Titanium and superalloys					
Aluminium		Al-Si		Cuivre Kupfer Copper		Laiton & bronze Messing & Bronze Brass & bronze		Ti grade 1 - 3		Ti grade 4 - 6		Superalliages Superlegierungen Superalloys	
VC (m/min)	F (mm/U)	VC (m/min)	F (mm/U)	VC (m/min)	F (mm/U)	VC (m/min)	F (mm/U)	VC (m/min)	F (mm/U)	VC (m/min)	F (mm/U)	VC (m/min)	F (mm/U)
		120-1500	0.03-0.20	80-300	0.03-0.15	100-400	0.03-0.18			30-70	0.03-0.15	40-80	0.03-0.12
						100-400	0.03-0.18			30-70	0.03-0.15	40-80	0.03-0.12
		120-1500	0.04-0.20	80-300	0.04-0.15	100-400	0.04-0.18			30-70	0.04-0.15	40-80	0.04-0.12
										30-70	0.06-0.20	40-80	0.06-0.20

Conseils d'utilisation

Anwendungsempfehlungen

Application recommendations

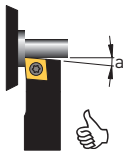

• pour un meilleur état de surface et une meilleure stabilité d'usinage, choisir une géométrie d'outil permettant un angle "a" le plus petit possible

• für bessere Oberflächegüte und Bearbeitungsstabilität, muss die Werkzeuggeometrie mit kleinstmöglichem Winkel "a" ausgewählt werden

• for a better surface finish and better machining stability, choose a tool geometry with angle "a" as small as possible

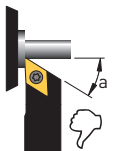

rapport hauteur de passe / rayon d'outil
Verhältnis zwischen Spantiefe und Werkzeugradius
machining depth / tool radius ratio

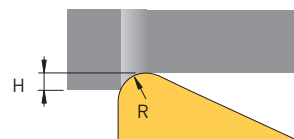

$H_{min} = 0.7 \times R$
 $R_{max} = 1.4 \times H$