

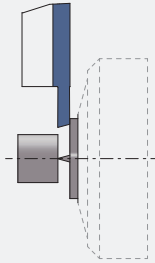

261

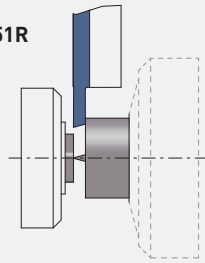

251R



262

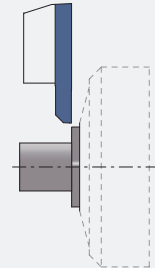

263

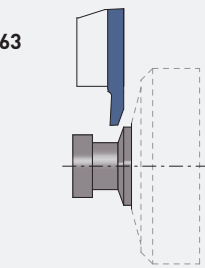

264

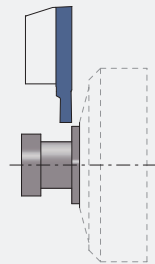

266

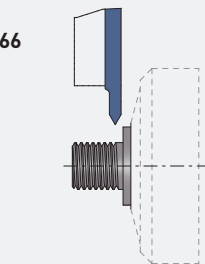

Index

Nuances
Sorten
Grades > 4.02

Paramètres de coupe indicatifs
Empfohlene Schnittwerte
Standard machining data > 4.03

Accessoires
Zubehör
Accessories

Porte-outils
Halter
Holders > 4.04

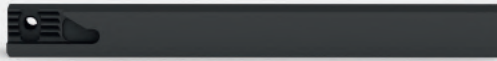

Tronçonnage
Abstechen
Parting off > 4.08

Type 251 / 261



Tournage avant
Vorwärts drehen
Front turning > 4.10

Type 252 / 262



Tournage arrière
Rückwärts drehen
Back turning > 4.11

Type 253 / 263



Fonçage-tournage
Einstechen und drehen
Grooving and turning > 4.14

Type 254 / 264



Filetage
Gewinde drehen
Threading > 4.16

Type 256 / 266



Plaquettes ébauches
WSP-Rohlinge
Blank inserts > 4.17

Type 251E / 261E



Usinage axial
Axiale Bearbeitung
Axial machining > 4.18 **new**

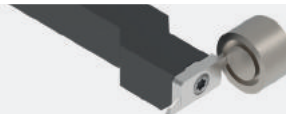

AP302

μK20 + revêtement PVD
μK20 + PVD Beschichtung
μK20 + PVD coating

- excellente nuance universelle
- 1^{er} choix pour l'usinage des aciers, aciers inoxydables et alliages de titane
- très bonne résistance à la température

- beste Universalsorte
- für die Bearbeitung von Stahl, rostfreiem Stahl und Titanlegierungen bestens geeignet
- sehr gute Warmfestigkeit

- best universal grade
- first choice for steel, stainless steel and titanium alloys machining
- very good heat resistance

AP202

μK20 + revêtement PVD
μK20 + PVD Beschichtung
μK20 + PVD coating

- nuance particulièrement adaptée aux faibles vitesses de coupe

- besonders geeignete Sorte für niedrige Schnittgeschwindigkeiten

- grade particularly suitable for low cutting speeds

N (μK20)

non revêtu
unbeschichtet
uncoated

- nuance micro-grain tenace
- supporte les coupes interrompues et autres conditions d'usinage défavorables

- zähe Feinkornsorte
- für unterbrochene Schnitte und andere ungünstige Bearbeitungsbedingungen geeignet

- tough micro-grain grade
- suitable for interrupted cut and other unfavourable machining conditions

AH302

μK10 + revêtement PVD
μK10 + PVD Beschichtung
μK10 + PVD coating

- nuance très résistante à l'usure
- pour l'usinage en finition dans des conditions favorables des aciers, aciers inoxydables et alliages de titane

- sehr verschleißfeste Sorte
- für die Feinbearbeitung von Stahl, rostfreiem Stahl und Titanlegierungen bei guten Bearbeitungsbedingungen

- very wear resistant grade
- for light machining of steel, stainless steel and titanium alloys under favourable machining conditions

HN (μK10)

non revêtu
unbeschichtet
uncoated

- nuance micro-grain très résistante à l'usure
- recommandé pour l'usinage du titane faiblement allié
- déconseillé en cas de coupe interrompue et autres conditions d'usinage défavorables

- verschleißfeste Feinkornsorte
- für die Bearbeitung von niedrig legiertem Titan empfehlenswert
- für unterbrochene Schnitte und andere ungünstige Bearbeitungsbedingungen nicht geeignet

- wear resistant micro-grain grade
- suitable for the machining of low alloyed titanium
- not suitable for interrupted cut and other unfavourable machining conditions

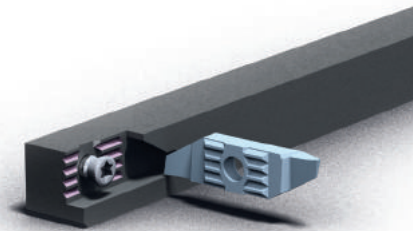

Rigid clamping system

Paramètres de coupe indicatifs

Empfohlene Schnittwerte



Standard machining data

Matière Werkstoff Material	Tournage Drehen Turning		Tronçonnage Abstechen Parting off	
	VC (m/min)	F (mm/U)	VC (m/min)	F (mm/U)
Acier de décolletage Automatenstahl Free-cutting steel (P)	120 - 200	0.01 - 0.20	80 - 150	0.01 - 0.15
Acier Stahl < 600 N/mm ² (P)	80 - 160	0.01 - 0.18	70 - 120	0.01 - 0.12
Acier Stahl < 800 N/mm ² (P)	60 - 120	0.01 - 0.15	60 - 100	0.01 - 0.10
Acier Stahl > 800 N/mm ² (P)	50 - 100	0.01 - 0.12	40 - 80	0.01 - 0.08
Acier inoxydable Rostfreistahl Stainless steel (M)	60 - 120	0.01 - 0.15	60 - 100	0.01 - 0.08
Aluminium (N)	180 - 800	0.01 - 0.30	150 - 300	0.01 - 0.20
Cuivre, laiton, bronze Kupfer, Messing, Bronze Copper, brass, bronze (N)	100 - 500	0.01 - 0.30	100 - 300	0.01 - 0.20
Titane Titan Titanium (S)	30 - 70	0.01 - 0.12	30 - 50	0.01 - 0.06

Accessoires

Zubehöre

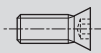
Accessories

Porte-outils Halter Holders			
250-8 / 260-8	V-M3.5X7.3-T15	C-T15	SET-NM-TX15
250-... / 260-...	V-M4X9-T15		
250RC / 260-C	V-M4X7.3-T15		

Recommandation de serrage
Drehmoment Empfehlung
Clamping recommendation

3.0 Nm

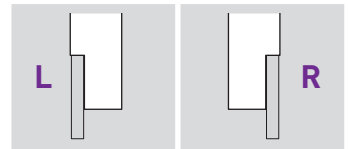
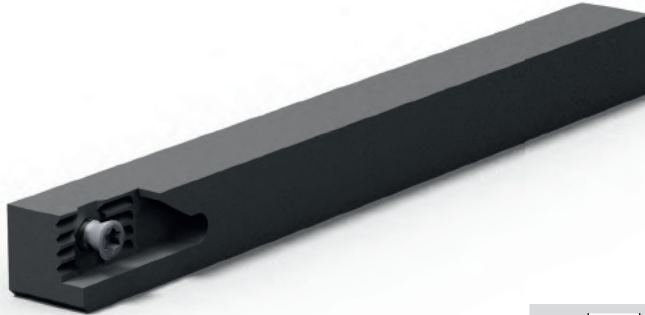
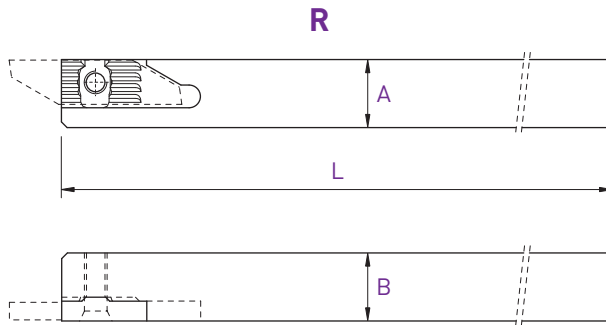

A x B	L	Art. N°	Art. N°
8 x 8	115	250-8	260-8
10 x 10	115	250-10	260-10
12 x 12	130	250-12	260-12
12 x 12	90	250-12-90	260-12-90
12.7 x 12.7	130	250-12.7	260-12.7
16 x 16	130	250-16	260-16
16 x 16	75	250-16-75	260-16-75
20 x 20	120	250-20	260-20

Chaque support est livré avec vis et clé.
 Jeder Halter wird mit Spannschraube(n) und Schlüssel geliefert.
 Screw(s) and key are included with each tool holder.

Porte-outils

Halter

Holder

260-C

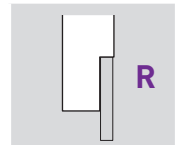
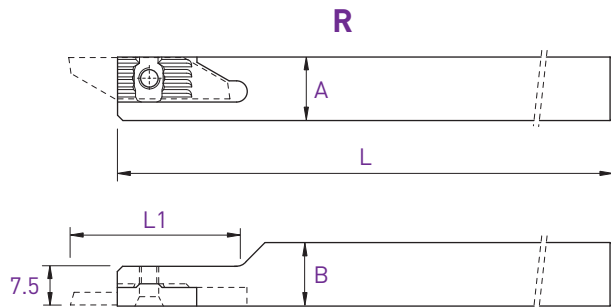
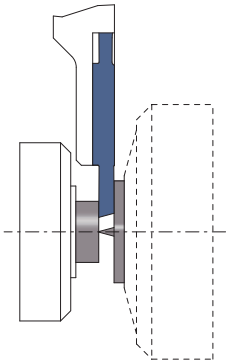

A x B	L	L1	Art. N°
12 x 12	130	30	260-C-12

Porte-outils

Halter

Holder

Coupe à droite déportée
Versetzes Rechtsschneiden
Right cut off line

250RC

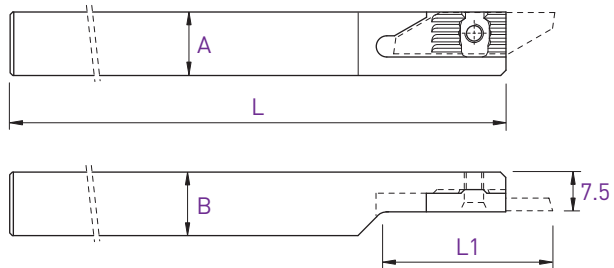
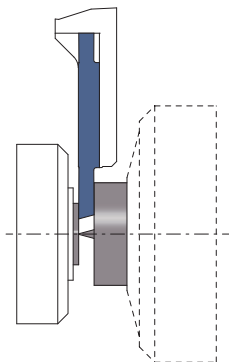

L (R)			
Coupe à droite déportée Versetzes Rechtsschneiden Right cut off line			
A x B	L	L1	Art. N°
12 x 12	130	30	250RC-12
16 x 16	130	40	250RC-16

Utiliser des plaquettes type 251R
WSP Typ 251R verwenden
Use inserts type 251R



Chaque support est livré avec vis et clé.
Jeder Halter wird mit Spannschraube(n) und Schlüssel geliefert.
Screw(s) and key are included with each tool holder.

Porte-outils avec arrosage intégré
 Halter mit integrierter Kühlmittelzufuhr
 Holders with integrated coolant supply

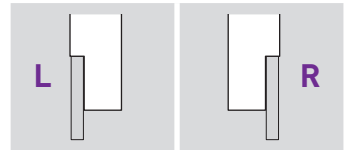
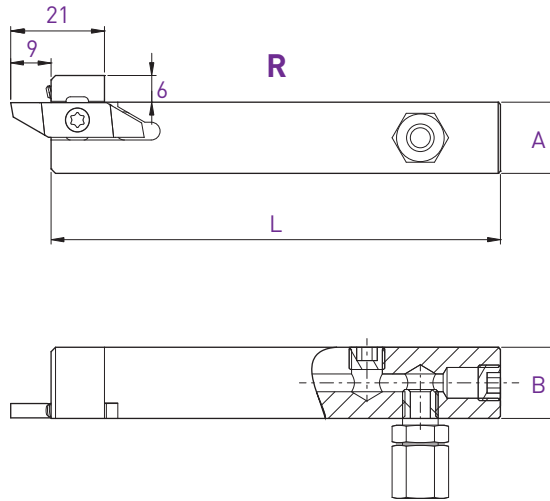
250-JET / 260-JET

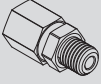

A x B	L	Art. N°	Art. N°
10 x 12	100	250-1012-JET	260-1012-JET
12 x 12	100	250-12-JET	260-12-JET
16 x 16	100	250-16-JET	260-16-JET
20 x 20	100	250-20-JET	260-20-JET

Pièces de rechange Ersatzteile Spare parts			Buse Düse Nozzle 
	Art. N°	Art. N°	Art. N°
250-JET / 260-JET	J-M8X1-D6	JB-M8X1	JJ-M3X6-D1.5

Chaque support est livré avec vis et clé.
 Jeder Halter wird mit Spannschraube(n) und Schlüssel geliefert.
 Screw(s) and key are included with each tool holder.

Porte-outils

Halter

Holder

260/250F

L/R

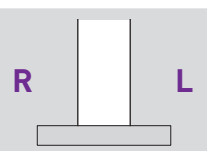
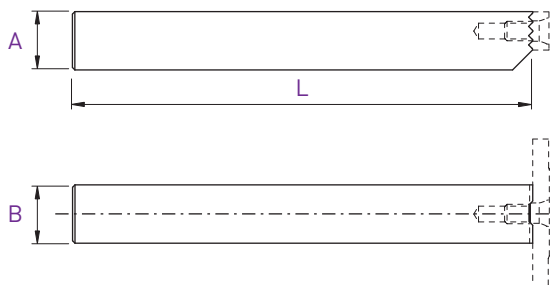

A x B	L	Art. N°
10 x 12	120	260/250F-1012
12 x 12	120	260/250F-1212

Porte-outils

Halter

Holder

260/250-D

L/R

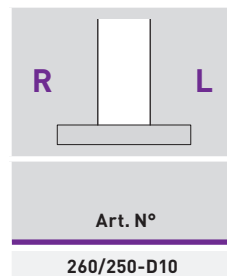
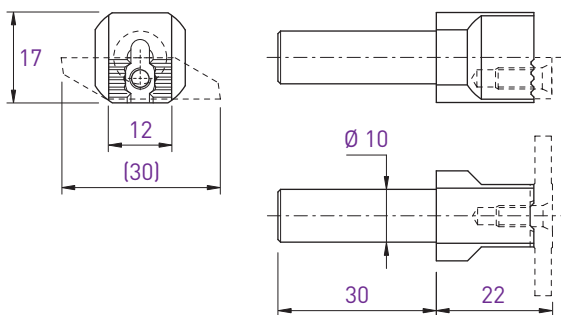

Chaque support est livré avec vis et clé.
 Jeder Halter wird mit Spannschraube(n) und Schlüssel geliefert.
 Screw(s) and key are included with each tool holder.

ECO-LINE

Tronçonnage
Abstechen
Parting off

251 / 261

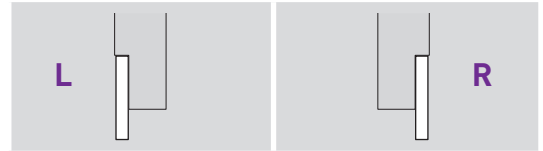
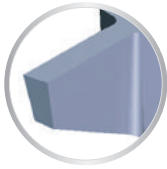
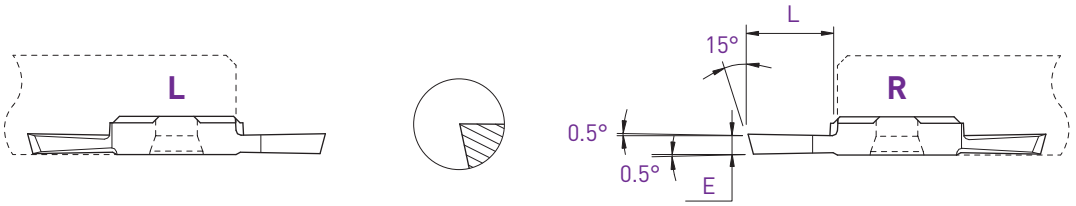

E	L	Art. N°	AP302	AP202	N (µk20)	Art. N°	AP302	AP202	N (µk20)
0.8	4	251-0.8	■	□	■	261-0.8	■	□	■
1.0	5	251-1.0	■	□	■	261-1.0	■	□	■
1.2	5	251-1.2	■	□	■	261-1.2	■	□	■
1.5	7	251-1.5	■	□	■	261-1.5	■	□	■
2.0	8.5	251-2.0	■	□	■	261-2.0	■	□	■
2.5	8.5	251-2.5	■	□	■	261-2.5	■	□	■

Tronçonnage
Abstechen
Parting off

Coupe déportée
Versetztes Schneiden
Cut off line

261L / 251R

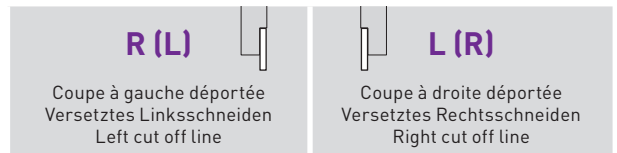
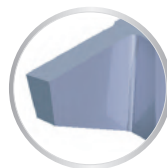
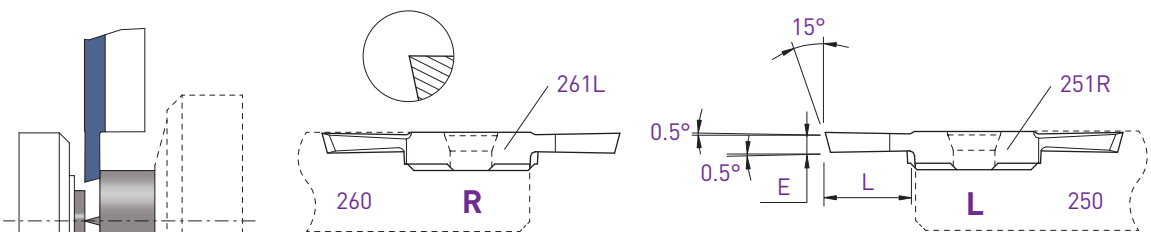

E	L	Art. N°	AP302	AP202	N (µk20)	Art. N°	AP302	AP202	N (µk20)
1.0	5	-				251R-1.0	■	□	■
1.5	7	-				251R-1.5	■	□	■
2.0	8.5	261L-2.0	■	□	■	251R-2.0	■	□	■

Tronçonnage

Abstechen

Parting off

251XF / 261XF

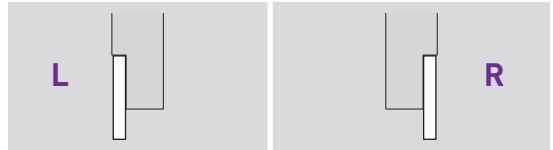
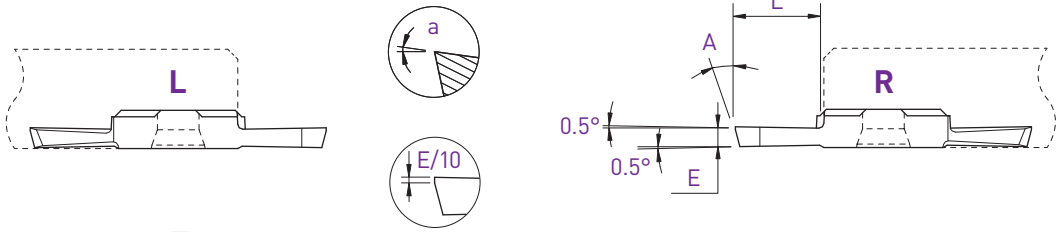

a	E	L	A	Art. N°	AP302	AP202	N (µk20)	Art. N°	AP302	AP202	N (µk20)
4°	1.0	4	15°	-				261XF-1.0	■	■	
6°	1.0	4	8°	-				261XF6°-1.0-8°	■	■	
4°	1.5	7	15°	251XF-1.5	■	□	■	261XF-1.5	■	□	■
4°	2.0	8.5	15°	251XF-2.0	■	□	■	261XF-2.0	■	□	■

Tronçonnage

Abstechen

Parting off

Coupe déportée

Versetztes Schneiden

Cut off line

251RXF

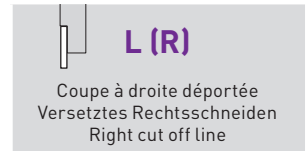
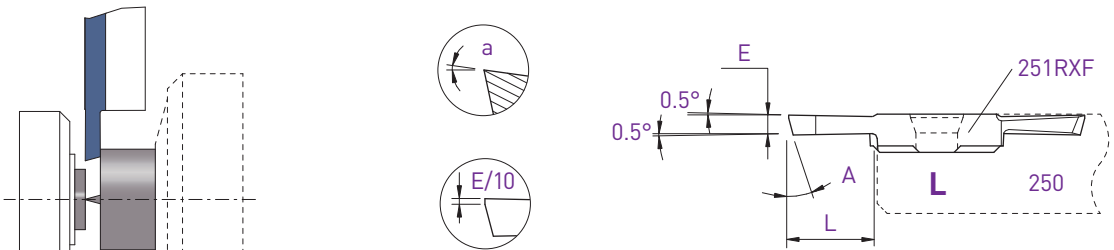

a	E	L	A	Art. N°	AP302	AP202	N (µk20)
6°	1.0	4	8°	251RXF6°-1.0-8°	■	■	
4°	1.5	7	15°	251RXF-1.5	■	□	■
4°	2.0	8.5	15°	251RXF-2.0	■	□	■

■ = disponible / verfügbar / available
 □ = selon disponibilité du stock / jenach Lagerverfügbarkeit / depending on stock availability

ECO-LINE

Tournage avant
Vorwärts drehen
Front turning

252 / 262

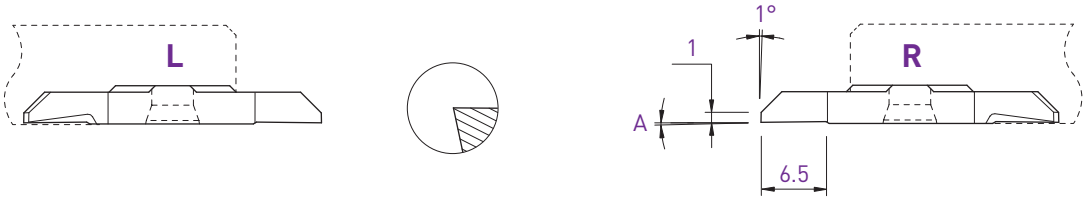

A	Art. N°	AP302	AP202	N (µk20)	Art. N°	AP302	AP202	N (µk20)
0°	252	■	□	■	262	■	□	■
2°	252-2°	■	□	■	262-2°	■	□	■

Tournage avant
Vorwärts drehen
Front turning

252X / 262X

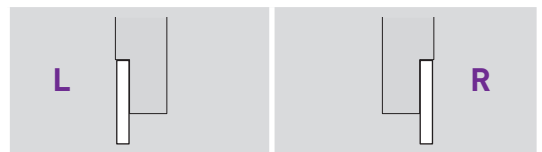
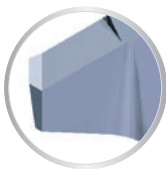
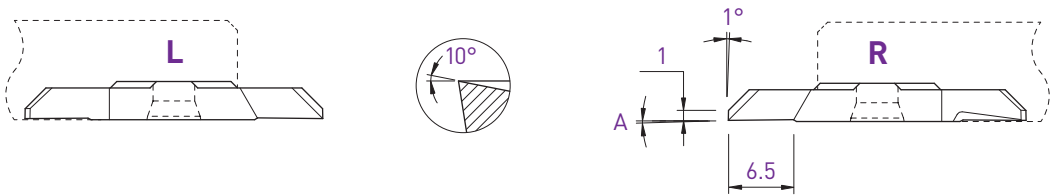

A	Art. N°	AP302	AP202	N (µk20)	Art. N°	AP302	AP202	N (µk20)
0°	252X	■	□	■	262X	■	□	■
2°	252X-2°	■	□	■	262X-2°	■	□	■

Tournage avant
Vorwärts drehen
Front turning

252S / 262S

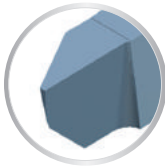
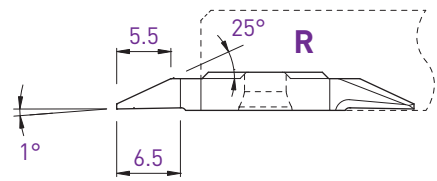
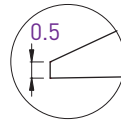
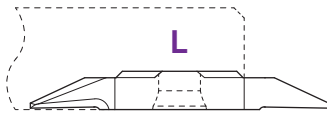

L				R			
Art. N°	AP302	AP202	N (µk20)	Art. N°	AP302	AP202	N (µk20)
252S05	■	□	■	262S05	■	□	■

Tournage arrière
Rückwärts drehen
Back turning

253S / 263S

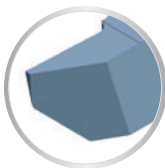
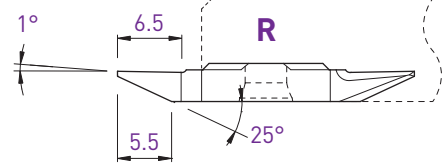
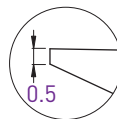
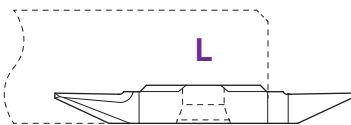

L				R			
Art. N°	AP302	AP202	N (µk20)	Art. N°	AP302	AP202	N (µk20)
253S05	■	□	■	263S05	■	□	■

ECO-LINE

Tournage arrière
Rückwärts drehen
Back turning

253 / 263

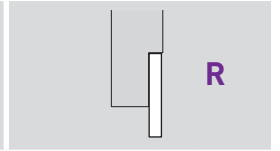
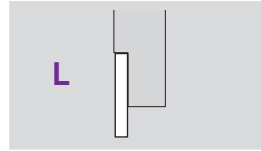
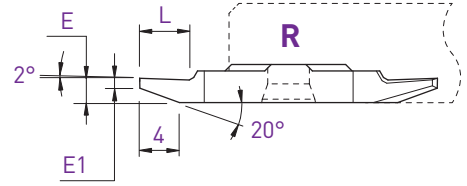
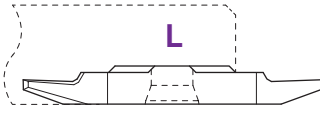

E	E1	L	Art. N°	AP302	AP202	N (µk20)	Art. N°	AP302	AP202	N (µk20)
2.0	0.5	4	253-0.5	■	□	■	263-0.5	■	□	■
2.5	1.0	5	253-1.0	■	□	■	263-1.0	■	□	■

Tournage arrière
Rückwärts drehen
Back turning

253X / 263X

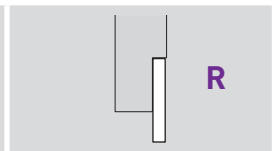
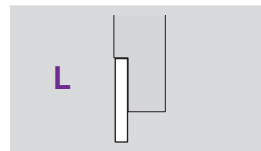
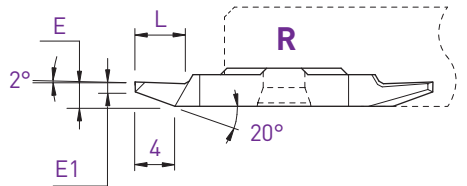
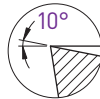
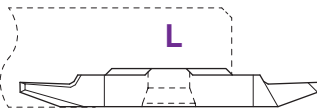

E	E1	L	Art. N°	AP302	AP202	N (µk20)	Art. N°	AP302	AP202	N (µk20)
2.0	0.5	5	253X-0.5	■	□	■	263X-0.5	■	□	■
2.5	1.0	5	253X-1.0	■	□	■	263X-1.0	■	□	■

Tournage arrière
Rückwärts drehen
Back turning

253VX-8° / 263VX-8°

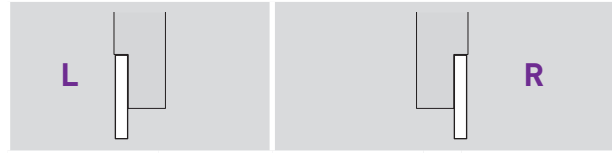
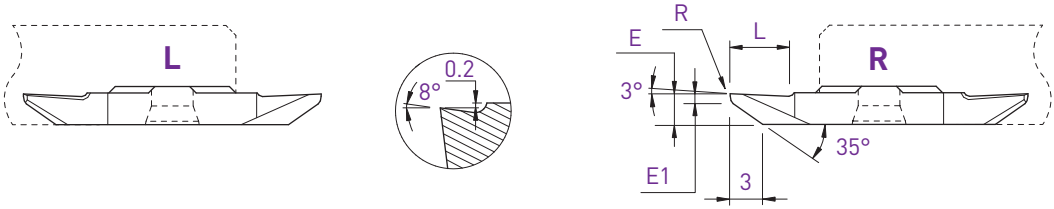

E	E1	L	R	Art. N°	AP302	AP202	N (µk20)	Art. N°	AP302	AP202	N (µk20)	AH302	HN (µk10)
3.1	1.0	6	0	253VX-8°	■	□	■	263VX-8°	■	□	■		
3.1	1.0	6	0.08	-				263VX-8°-R08	■	□	■	■	■
3.1	1.0	6	0.20	-				263VX-8°-R20	■	□	■	■	■

Tournage arrière
Rückwärts drehen
Back turning

253VX-805 / 263VX-805

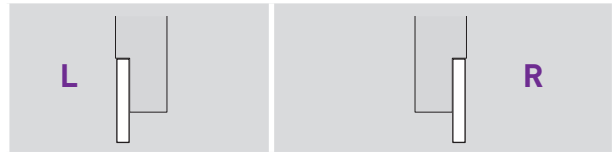
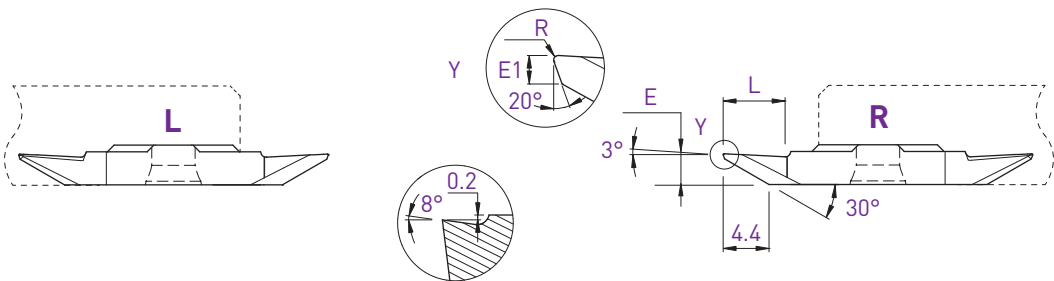

E	E1	L	R	Art. N°	AP302	AP202	N (µk20)	Art. N°	AP302	AP202	N (µk20)	AH302	HN (µk10)
3.0	0.5	6	0.08	253VX-805-R08	■	□	■	263VX-805-R08	■	□	■	■	■

■ = disponible / verfügbar / available
□ = selon disponibilité du stock / jenach Lagerverfügbarkeit / depending on stock availability

ECO-LINE

Fonçage-tournage
 Einstechen und drehen
 Grooving and turning

254 / 264

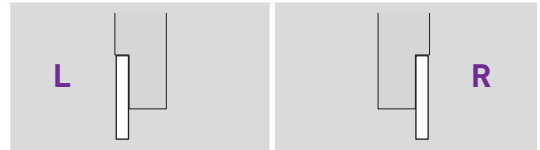
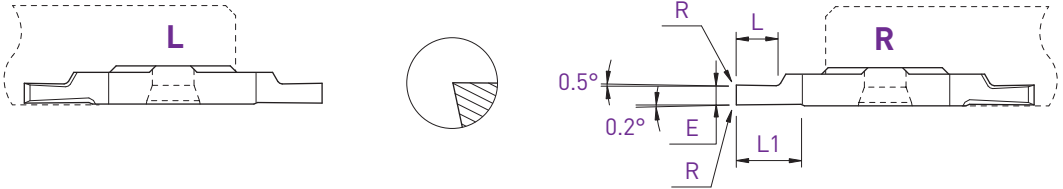

E	L	L1	R	Art. N°	AP302	AP202	N [$\mu\text{m}20$]	Art. N°	AP302	AP202	N [$\mu\text{m}20$]
0.8	2	4	0	254-0.8	■	□	■	264-0.8	■	□	■
1.0	2.5	4	0	254-1.0	■	□	■	264-1.0	■	□	■
1.2	3	4	0	254-1.2	■	□	■	264-1.2	■	□	■
1.5	3	4	0	254-1.5	■	□	■	264-1.5	■	□	■
1.8	4	6.5	0	-				264-1.8	■	□	■
2.0	4	6.5	0	254-2.0	■	□	■	264-2.0	■	□	■
2.5	6	6.5	0	254-2.5	■	□	■	264-2.5	■	□	■
3.0	6.5	6.5	0	254-3.0	■	□	■	264-3.0	■	□	■

Fonçage-tournage

Einstecken und drehen

Grooving and turning

254X / 264X

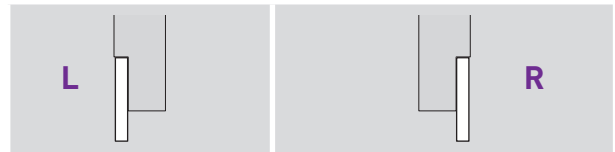
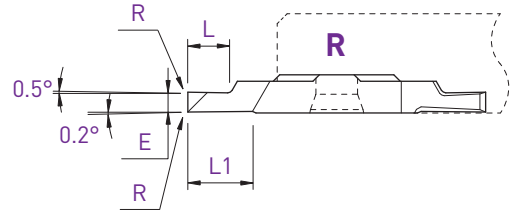
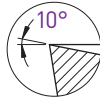
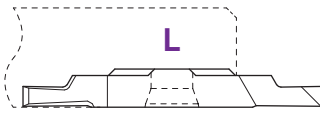

E	L	L1	R	Art. N°	AP302	AP202	N [µk20]	Art. N°	AP302	AP202	N [µk20]	AH302	HN [µk10]
0.8	2	4	0	254X-0.8	■	□	■	264X-0.8	■	□	■		
1.0	2.5	4	0	254X-1.0	■	□	■	264X-1.0	■	□	■		
1.0	2.5	4	0.08	-				264X-1.0-R08	■	□	■	■	■
1.2	3	4	0	254X-1.2	■	□	■	264X-1.2	■	□	■		
1.5	3	4	0	254X-1.5	■	□	■	264X-1.5	■	□	■		
1.5	3	4	0.08	-				264X-1.5-R08	■	□	■	■	■
1.5	3	4	0.20	-				264X-1.5-R20	■	□	■	■	■
2.0	4	6.5	0	254X-2.0	■	□	■	264X-2.0	■	□	■		
2.0	4	6.5	0.08	-				264X-2.0-R08	■	□	■	■	■
2.0	4	6.5	0.20	-				264X-2.0-R20	■	□	■	■	■
2.5	6	6.5	0	254X-2.5	■	□	■	264X-2.5	■	□	■		
2.5	6.5	6.5	0.08	-				264X-2.5-R08	■	□	■	■	■
2.5	6.5	6.5	0.20	-				264X-2.5-R20	■	□	■	■	■
3.0	6.5	6.5	0	254X-3.0	■	□	■	264X-3.0	■	□	■		
3.0	6.5	6.5	0.08	-				264X-3.0-R08	■	□	■	■	■
3.0	6.5	6.5	0.20	-				264X-3.0-R20	■	□	■	■	■

Filetage
Gewinde drehen
Threading

Partial profile 60°

256-60 / 266-60

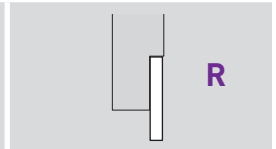
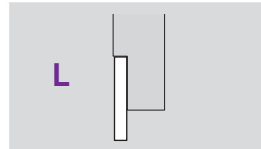
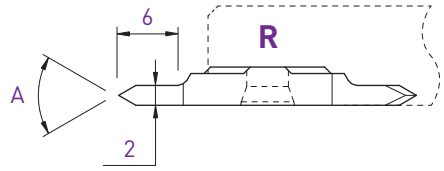
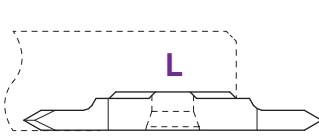

A	R	a	Art. N°	AP302	AP202	N (µk20)	Art. N°	AP302	AP202	N (µk20)
60°	0	0°	256-60-2.0	■	□	■	266-60-2.0	■	□	■
60°	0.06	3°	256-AG60°	■	□	■	266-AG60°	■	□	■

Filetage
Gewinde drehen
Threading

Partial profile 55°

256-55 / 266-55

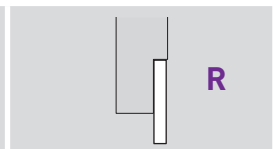
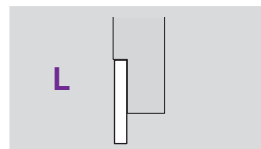
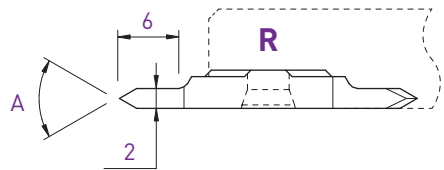
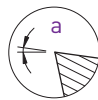
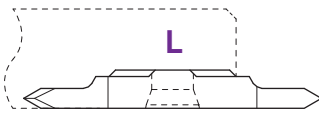

A	R	a	Art. N°	AP302	AP202	N (µk20)	Art. N°	AP302	AP202	N (µk20)
55°	0	0°	256-55-2.0	■	□	■	266-55-2.0	■	□	■
55°	0.06	3°	256-AG55°	■	□	■	266-AG55°	■	□	■

Plaquettes ébauches

WSP-Rohlinge

Blank inserts

251-E / 261-E

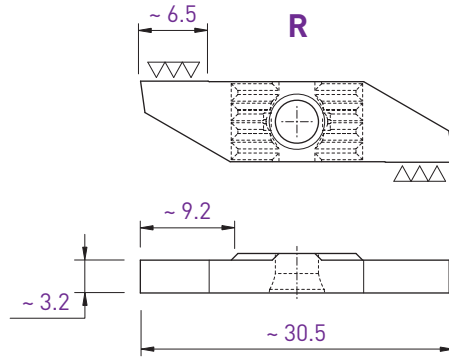
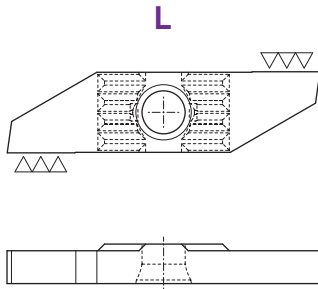

L					R						
Art. N°	AP302	AP202	N [µkt20]	AH302	HN [µkt10]	Art. N°	AP302	AP202	N [µkt20]	AH302	HN [µkt10]
251-E	■	□	■	■	■	261-E	■	□	■	■	■

new

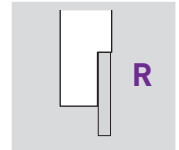
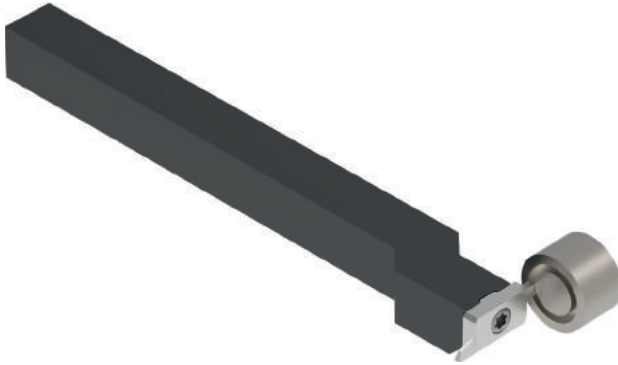
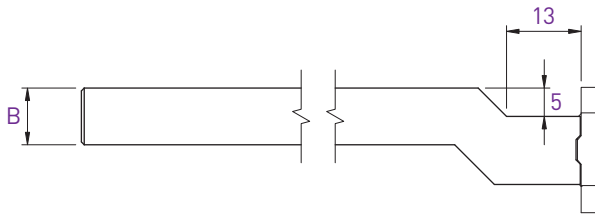
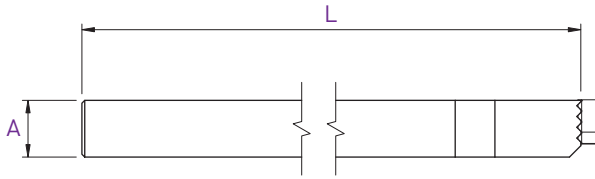

A x B	L	Art. N°
8x10	130	250RFG-0810
10x10	130	250RFG-1010
12x12	130	250RFG-1212
16x16	130	250RFG-1616

Pièces de rechange
Ersatzteile
Spare parts

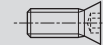

Art. N°

V-M4X9-T15

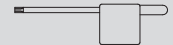

Art. N°

C-T15

Plaquettes ébauches

WSP-Rohlinge

Blank inserts

251RFG

new

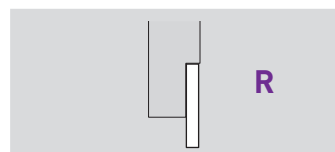
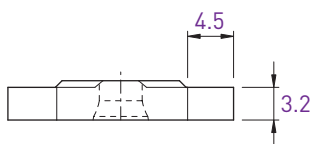
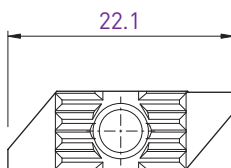

Art. N°	N (µm20)	AP302
251RFG-EP	■	■