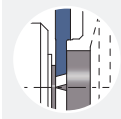

Nuances micro-grain à dureté élevée  
 Verschleissfeste Feinkornsorten  
 Wear resistant micro-grain grades > **2.02**

Pièces de rechange  
 Ersatzteile  
 Spare parts > **2.05**

	pour machines à cames für kurvengesteuerte Maschinen for cam driven machines		pour machines CNC für CNC-Maschinen for CNC driven machines		
	L		L	R	
	710 710SF 710-NOVIBRA	> <b>2.06</b>	730 730-NOVIBRA	740 740SF 740-NOVIBRA	> <b>2.10</b>
	711SF	> <b>2.08</b>		741SF	> <b>2.13</b>
	712SF	> <b>2.08</b>		742SF	> <b>2.13</b>
	713SF	> <b>2.09</b>		743SF	> <b>2.15</b>
			736SF	746SF	> <b>2.17</b>
				748SF	> <b>2.18</b>
				749SF	> <b>2.18</b>
	711-ESF	> <b>2.09</b>	731-ESF	741-ESF	> <b>2.19</b>

*Coupe à droite déportée / Versetztes Rechtsschneiden / Right cut off line*

**730RC**  
**750RC**

> **2.20**

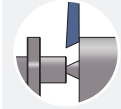

**731R**  
**751R**

> **2.21**

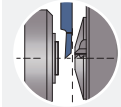

**770-SN-SF**

> **2.22** **new**

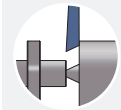

**771RVSF**

> **2.24** **new**

Halter für SwissNano  
Porte-outils pour Swissnano - MODU-Line  
Holder for SwissNano

**ML12**

> **2.24**

## Nuances micro-grain à dureté élevée

### Verschleissfeste Feinkornsorten

### Wear resistant micro-grain grades

**new**

#### N ( $\mu$ K20)

non revêtu  
unbeschichtet  
uncoated

- nuance micro-grain tenace, résistante aux conditions défavorables, recommandée pour des opérations de coupe dans des matières ne nécessitant aucun revêtement
- zähe Feinkornsorte, in ungünstige Bearbeitungs-konditionen widerstandsfähig, für Schnittbearbeitung empfohlen, die keine Beschichtung erfordern
- tough micro-grain grade, suitable for unfavorable machining conditions, suitable for cutting in material that do not necessitate any tool coating

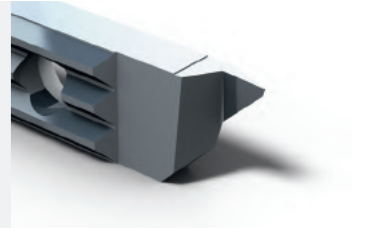

**new**

#### TAF

$\mu$ K20 + revêtement PVD  
 $\mu$ K20 + PVD Beschichtung  
 $\mu$ K20 + PVD coating

- nuance tenace résistante aux conditions défavorables, recommandée pour des opérations de coupes dans les aciers et aciers inoxydables.
- zähe widerstandsfähige Sorte in ungünstigen Bearbeitungskonditionen, für Schnittbearbeitung in Stahl und rostfreiem Stahl empfohlen
- tough grade, resistant to unfavorable machining conditions, suitable for cutting of steel and stainless steel

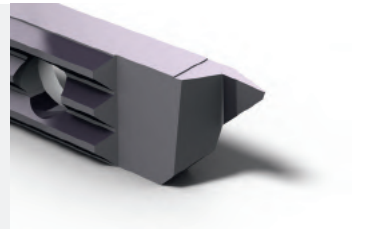

#### HN ( $\mu$ K10)

non revêtu  
unbeschichtet  
uncoated

- nuance micro-grain, bonne résistance à l'usure, recommandée pour des opérations d'ébauche et de finition pour des matières ou usinages ne nécessitant aucun revêtement
- verschleissfeste Feinkornsorte, für Schruppen und Schlichtbearbeitung empfohlen oder für Werkstoffe oder Bearbeitungen, die keine Beschichtung erfordern
- wear resistant micro-grain carbide, recommended for roughing and finishing and for materials or operations that do not necessitate any tool coating

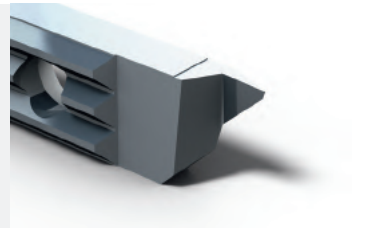

#### HTC

$\mu$ K10 + revêtement PVD  
 $\mu$ K10 + PVD Beschichtung  
 $\mu$ K10 + PVD coating

- nuance résistante à l'usure, faible coefficient de frottement, recommandée pour des opérations d'ébauche et de finition
- verschleissfeste Sorte, geringer Reibwert, für Schruppen und Schlichtbearbeitung empfohlen
- wear resistant grade, low friction ratio, recommended for roughing and finishing

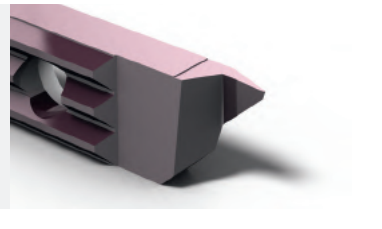

conseillée pour l'usinage de la matière 20AP  
für Bearbeitung von 20AP geeignet  
suitable for machining of 20AP material

#### HTC-RE

$\mu$ K10 + revêtement PVD  
 $\mu$ K10 + PVD Beschichtung  
 $\mu$ K10 + PVD coating

- nuance identique à HTC avec dépouilles rectifiées après revêtement pour des opérations de finition
- gleiche Sorte wie HTC nach der Beschichtung geschliffener Freiwinkel, für Schlichtbearbeitung empfohlen
- same grade as HTC, after coating grounded clearance, recommended for finishing

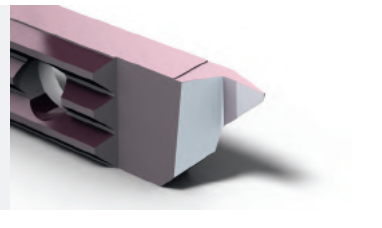

conseillée pour l'usinage de la matière 20AP  
für Bearbeitung von 20AP geeignet  
suitable for machining of 20AP material

## Nuances micro-grain à dureté élevée

### Verschleissfeste Feinkornsorten

### Wear resistant micro-grain grades

#### HTAF

μK10 + revêtement PVD  
μK10 + PVD Beschichtung  
μK10 + PVD coating

- nuance résistante à l'usure, recommandée pour des opérations d'ébauche et de finition
- verschleissfeste Sorte, für Schruppen und Schlichtbearbeitung empfohlen
- wear resistant grade, recommended for roughing and finishing



*conseillée pour l'usinage des matières Finamac et inox 4c27a  
für Bearbeitung von Finamac und 4c27a-Rostfreier Stahl geeignet  
suitable for machining of Finamac and 4c27a stainless steel*

#### HTAF-RE

μK10 + revêtement PVD  
μK10 + PVD Beschichtung  
μK10 + PVD coating

- nuance identique à HTAF avec dépouilles rectifiées après revêtement pour des opérations de finition
- gleiche Sorte wie HTAF nach der Beschichtung geschliffener Freiwinkel, für Schlichtbearbeitung empfohlen
- same grade as HTAF, after coating grounded clearance, recommended for finishing

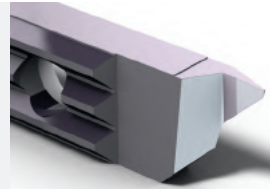

*recommandée pour les matières Finamac et inox 4c27a  
für Bearbeitung von Finamac und 4c27a-Rostfreier Stahl geeignet  
suitable for machining of Finamac and 4c27a stainless steel*

#### HTAXF

μK10 + revêtement PVD  
μK10 + PVD Beschichtung  
μK10 + PVD coating

- nuance complémentaire, résistante à l'usure et à la température pour l'usinage ébauche et finition des matières inox 304, 316L, 317L, 904, Phynox Aciers alliés contenant: Chrome Nickel, Vanadium, molybdène...
- komplementäre Sorte, verschleissfest und temperaturbeständig. Für Schruppen und Schlichtbearbeitung von Materialien Innox 304, 316L, 317L, 904, Phynox Legierter Stahl enthaltend Chrom-Nickel, Vanadium, Molybdän...
- complementary grade, wear and temperature resistant for roughing and finishing of following materials: Innox 304, 316L, 317L, 904, Phynox Alloy steel containing Chrome-nickel, Vanadium, Molybdenum...

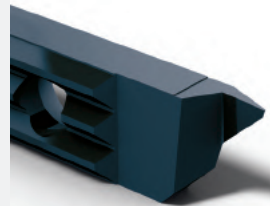

#### HTAXF-RE

μK10 + revêtement PVD  
μK10 + PVD Beschichtung  
μK10 + PVD coating

- nuance identique à HTAXF avec dépouilles rectifiées après revêtement pour des opérations de finition
- gleiche Sorte wie HTAXF nach der Beschichtung geschliffener Freiwinkel, für Schlichtbearbeitung empfohlen
- same grade as HTAXF, after coating grounded clearance, recommended for finishing

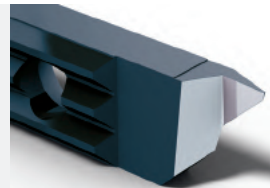

#### HTiN

μK10 + revêtement PVD  
μK10 + PVD Beschichtung  
μK10 + PVD coating

- nuance résistante à l'usure, faible coefficient de frottement, recommandée pour des opérations d'ébauche et de finition
- verschleissfeste Sorte, geringer Reibwert, für Schruppen und Schlichtbearbeitung empfohlen
- wear resistant grade, low friction ratio, recommended for roughing and finishing



Nuances micro-grain à dureté élevée

Verschleissfeste Feinkornsorten

Wear resistant micro-grain grades

## XN ( $\mu$ K01)

non revêtu  
unbeschichtet  
uncoated

- nuance micro-grain très résistante à l'usure, recommandée pour des opérations d'ébauche et de finition pour des matières ou usinages nécessitant aucun revêtement
- sehr verschleissfeste Sorte, für Schruppen und Schlichtbearbeitung empfohlen oder für Werkstoffe oder Bearbeitungen, die keine Beschichtung erfordern
- wear resistant micro-grain carbide, recommended for roughing and finishing and for materials or operations that do not necessitate any tool coating

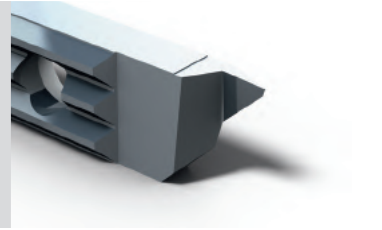

## XTC

$\mu$ K01 + revêtement PVD  
 $\mu$ K01 + PVD Beschichtung  
 $\mu$ K01 + PVD coating

- nuance très résistante à l'usure, faible coefficient de frottement, recommandée pour des opérations de finition
- sehr verschleissfeste Sorte, geringer Reibwert, für Schlichtbearbeitung empfohlen
- very wear resistant grade, low friction ratio, recommended for finishing

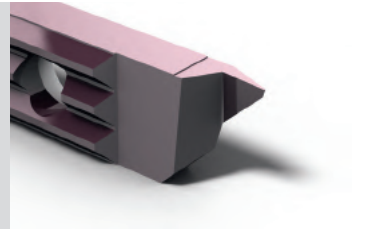

## XTAF

$\mu$ K01 + revêtement PVD  
 $\mu$ K01 + PVD Beschichtung  
 $\mu$ K01 + PVD coating

- nuance très résistante à l'usure, recommandée pour des opérations de finition, conseillée pour l'usinage des matières très abrasives
- sehr verschleissfeste Sorte, für Schlichtbearbeitung empfohlen, für die Bearbeitung von sehr abrasive Rohstoffe geeignet
- very wear resistant grade, recommended for finishing, suitable for machining of very abrasive materials

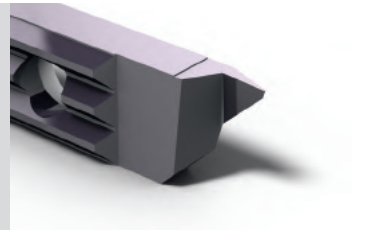

## XTAF-RE

$\mu$ K01 + revêtement PVD  
 $\mu$ K01 + PVD Beschichtung  
 $\mu$ K01 + PVD coating

- nuance identique à XTAF avec dépouilles rectifiées après revêtement pour des opérations de finition
- gleiche Sorte wie XTAF nach der Beschichtung geschliffener Freiwinkel, für Schlichtbearbeitung empfohlen
- same grade as XTAF, after coating grounded clearance, recommended for finishing

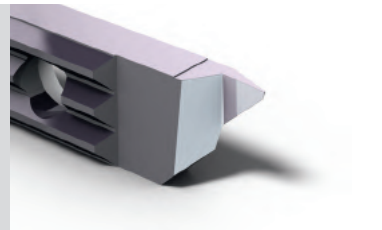

**Nuances micro-grain à dureté élevée**

**Verschleissfeste Feinkornsorten**

**Wear resistant micro-grain grades**

## XTAXF

μK01 + revêtement PVD  
μK01 + PVD Beschichtung  
μK01 + PVD coating

- nuance complémentaire très résistante à l'usure et à la température pour la finition des matières inox 304, 316L, 317L, 904, Phynox  
Aciers alliés contenant: Chrome Nickel, Vanadium, Molybdène...
- komplémentere Sorte, sehr verschleissfest und temperaturbeständig. Für Schlichtbearbeitung von Materialien Inox 304, 316L, 317L, 904, Phynox  
Legierter Stahl enthaltend Chrom-Nickel, Vanadium, Molybdän...
- complementary grade, very wear and temperature resistant for finishing of following materials: Inox 304, 316L, 317L, 904, Phynox  
Alloy steel containing Chrome-nickel, Vanadium, Molybdenum...

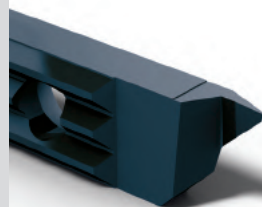

## XTAXF-RE

μK01 + revêtement PVD  
μK01 + PVD Beschichtung  
μK01 + PVD coating



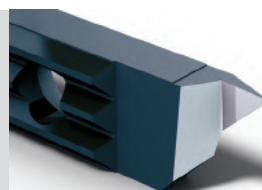

- nuance identique à XTAXF avec dépouilles rectifiées après revêtement pour des opérations de finition
- gleiche Sorte wie XTAXF nach der Beschichtung geschliffener Freiwinkel, für Schlichtbearbeitung empfohlen
- same grade as XTAXF, after coating grounded clearance, recommended for finishing



**Pièces de rechange**

**Ersatzteile**

**Spare parts**

	Porte-outils Halter Holders	Serrage standard (A) Standard Spannsystem (A) Standard clamping system (A)		Serrage type B Spannsystem Typ B Clamping system type B	
					
<b>710</b>	710-6 / - NOVIBRA	<b>V-M2.5X5.8-T8</b>	<b>C-T8</b>	-	-
	710-7 / - NOVIBRA / - SF	<b>V-M2.5X6.5-T8</b>			
	710-8 / - NOVIBRA / -SF	<b>V-M2.5X7.8-T8</b>			
	710-10 - 710-12				
<b>730</b>	730-7 / - NOVIBRA	<b>V-M3X7-T8</b>	<b>C-T8</b>	-	-
	730-8 / - NOVIBRA			<b>V-M2.5X7.8-T8</b>	<b>C-T8</b>
	730-10 - 730-12			-	-
	730RC			<b>V-M3X5.5-T8</b>	-
<b>740</b>	740-7 / -NOVIBRA / -SF	<b>V-M3X7-T8</b>	<b>C-T8</b>	-	-
	740-8 -12 / -SF / -NOVIBRA			<b>V-M2.5X7.8-T8</b>	<b>C-T8</b>
<b>750</b>	750RC	<b>V-M4X7.3-T15</b>	<b>C-T15</b>	-	-
<b>770</b>	770-SN-SF	<b>V-M4X7.3-T15</b>	<b>C-T15</b>	-	-

Porte-outils

Halter

Holder

L

710

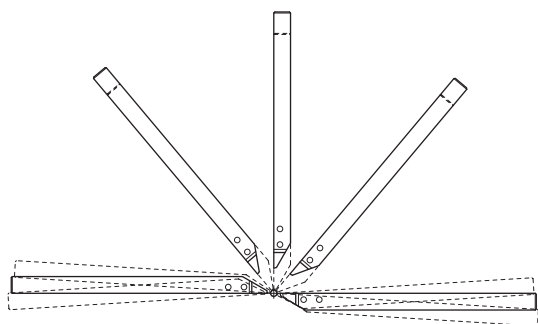

Porte-outils pour machines à cames à gauche  
 Halter für linksdrehende kurvgesteuerte Maschinen  
 Tool holders for left hand turning cam driven machines

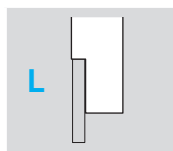
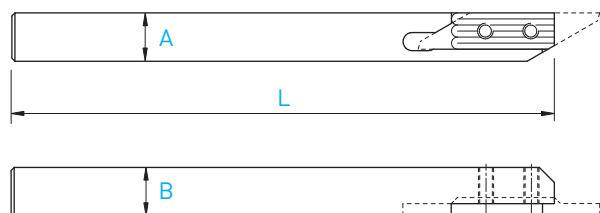

A x B	L	Serrage Spannsystem Clamping	Art. N°
6 x 6	115	A	<b>710-6</b>
7 x 7	115	A	<b>710-7</b>
8 x 8	115	A	<b>710-8</b>
8 x 8	140	A	<b>710-8-140</b>
10 x 10	115	A	<b>710-10</b>
12 x 12	130	A	<b>710-12</b>

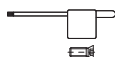

Chaque support est livré avec vis et clé.  
 Jeder Halter wird mit Spanschraube(n) und Schlüssel geliefert.  
 Screw(s) and key are included with each tool holder.

Porte-outils

Halter

Holders

L

710-SF

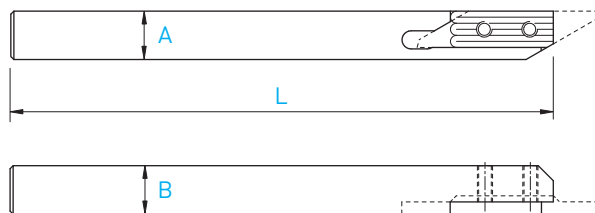

Super finition des 4 faces  
4 seitig feinstgeschliffen  
4 sides superfinish

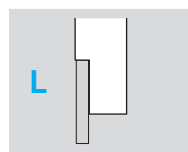

A x B	L	Serrage Spannsystem Clamping	Art. N°
7 x 7	140	A	710-7-140-SF
8 x 8	140	A	710-8-140-SF

Porte-outils en métal lourd anti-vibratoire

Schwingungdämpfender Schwermetallhalter

Low vibration heavy metal holders

L

710-NOVIBRA

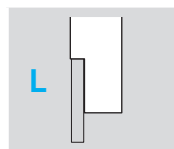
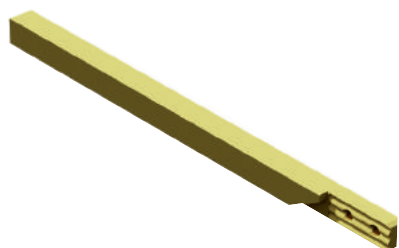

A x B	L	Serrage Spannsystem Clamping	Art. N°
6 x 6	115	A	710-6-NOVIBRA
7 x 7	115	A	710-7-NOVIBRA
8 x 8	115	A	710-8-NOVIBRA

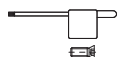

Chaque support est livré avec vis et clé.  
Jeder Halter wird mit Spannschraube(n) und Schlüssel geliefert.  
Screw(s) and key are included with each tool holder.



# TOP-WATCH

Plaquettes d'horlogerie pour machines à cames

Uhrenindustrie-WSP für kurvengesteuerte Maschinen

Watch industry inserts for cam driven machines

L

711SF / 712SF

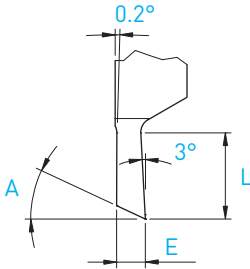
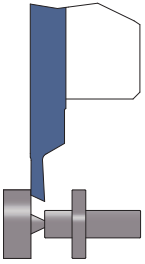

Tronçonnage  
Abstechen  
Parting off

E	L	A	Art. N°	HTC	HTC-RE	HTAF	HTiN	HN (µK10)
0.8	3.0	25°	711SF-0.8-25°	■	■	■	■	■
1.0	3.0	25°	711SF-1.0-25°	■	□	■	□	■

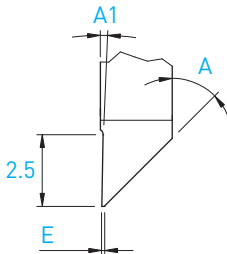
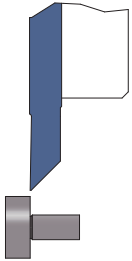

Tournage avant ébauche / finition  
Vorwärts drehen schruppen / schlichten  
Front turning for roughing / finishing

E	A	A1	Art. N°	HTC	HTC-RE	HTAF	HTiN	HN (µK10)
0.03	45°	3°	712SF-3/3-45°	■	□	■	□	■
0.08	45°	1°	712SF-8/8-45°	■	■	■	□	■

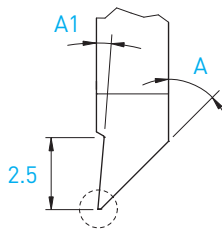
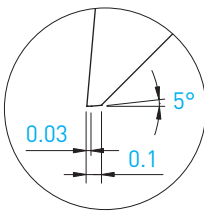
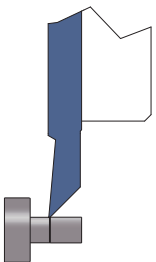

Tournage avant finition (pivotage)  
Vorwärts drehen schlichten  
Front turning for finishing

A	A1	Art. N°	HTC	HTC-RE	HTAF	HTiN	HN (µK10)
45°	3°	712SF-10/3	■	□	■	■	■

Plaquettes d'horlogerie pour machines à cames

Uhrenindustrie-WSP für kurvengesteuerte Maschinen

Watch industry inserts for cam driven machines

L

713SF

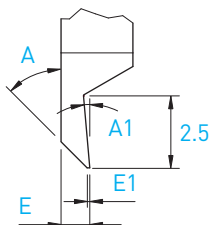
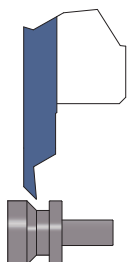

Tournage arrière ébauche / finition  
Rückwärts drehen schrappen / schlichten  
Back turning for roughing / finishing

E1	E	A	A1	Art. N°	HTC	HTC-RE	HTAF	HTiN	HN (µK10)
0.03	1.0	45°	5°	713SF-3/3-45°-1.0	■	□	□	□	■
0.10	1.0	45°	5°	713SF-10/10-45°-1.0	■	□	■	□	■

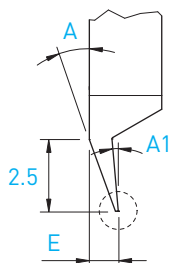
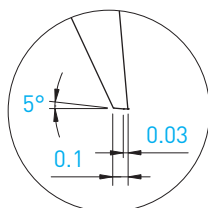
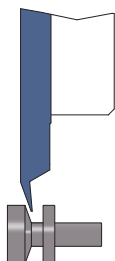

Tournage arrière finition  
Rückwärts drehen schlichten  
Back turning for finishing

E	A	A1	Art. N°	HTC	HTC-RE	HTAF	HTiN	HN (µK10)
1.0	20°	5°	713SF-10/3	■	□	■	■	■

Plaquettes ébauches

WSP-Rohlinge

Blank inserts

L

711-ESF

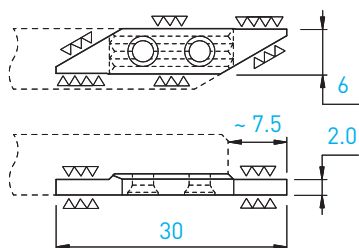

Art. N°	HTC	HTAF	HTiN	HN (µK10)	XN (µK01)	XTC	XTAF
711-ESF	■	■	□	■	■	■	■

Porte-outils

Halter

Holder

L/R

730 / 740

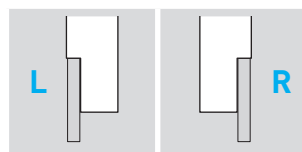
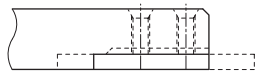
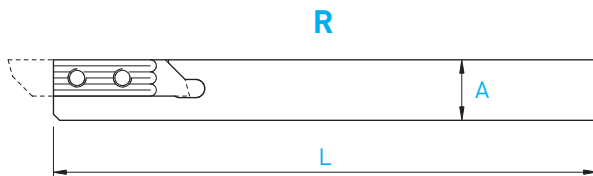
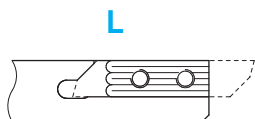

A x B	L	Serrage Spannsystem Clamping	Art. N°	Art. N°
7 x 7	115	A	<b>730-7</b>	<b>740-7</b>
8 x 8	115	A + B	<b>730-8</b>	<b>740-8</b>
8 x 8	140	A + B	<b>730-8-140</b>	-
10 x 10	115	A + B	<b>730-10</b>	<b>740-10</b>
12 x 12	130	A + B	<b>730-12</b>	<b>740-12</b>
12 x 12	90	A + B	<b>730-12-90</b>	<b>740-12-90</b>

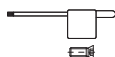

Chaque support est livré avec vis et clé.  
Jeder Halter wird mit Spannschraube(n) und Schlüssel geliefert.  
Screw(s) and key are included with each tool holder.

Porte-outils

Halter

Holder

R

740-SF

R

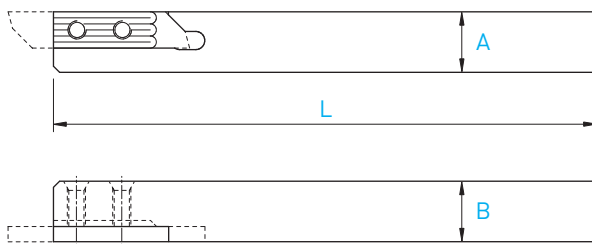

Super finition des 4 faces  
4 seitig feinstgeschliffen  
4 sides superfinish

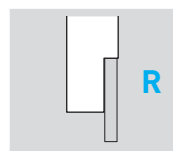

A x B	L	Serrage Spannsystem Clamping	Art. N°
7 x 7	90	A	740-7-90-SF
8 x 8	115	A + B	740-8-SF
8 x 8	90	A + B	740-8-90-SF
10 x 10	115	A + B	740-10-SF
10 x 10	90	A + B	740-10-90-SF
12 x 12	130	A + B	740-12-SF
12 x 12	90	A + B	740-12-90-SF

Porte-outils en métal lourd anti-vibratoire

Schwingungdämpfender Schwermetallhalter

Low vibration heavy metal holders

L/R

730 / 740-NOVIBRA

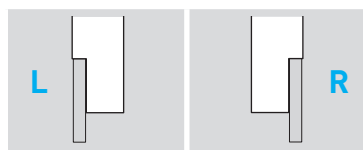

A x B	L	Serrage Spannsystem Clamping	Art. N°	Art. N°
7 x 7	115	A	730-7-NOVIBRA	740-7-NOVIBRA
8 x 8	115	A + B	730-8-NOVIBRA	740-8-NOVIBRA
8 x 8	80	A + B	-	740-8-80-NOVIBRA
10 x 10	115	A + B	-	740-10-NOVIBRA
12 x 12	130	A + B	-	740-12-NOVIBRA

Chaque support est livré avec vis et clé.  
Jeder Halter wird mit Spannschraube(n) und Schlüssel geliefert.  
Screw(s) and key are included with each tool holder.

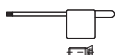

Porte-outils

Halter

Holder

R

740X3-SF

**new**

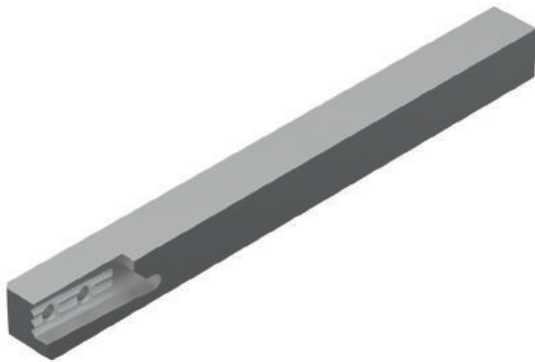
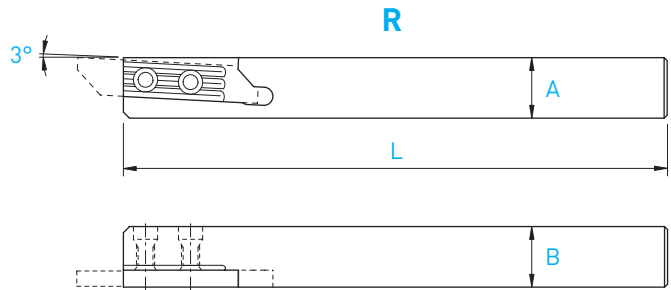

A x B	L	Serrage Spannsystem Clamping	Art. N°
8 x 8	115	A + B	<b>740X3-8-SF</b>
10 x 10	115	A + B	<b>740X3-10-SF</b>
12 x 12	130	A + B	<b>740X3-12-SF</b>

Plaquettes d'horlogerie pour machines CNC

Uhrenindustrie-WSP für CNC-Maschinen

Watch industry inserts for CNC machines

R

741SF / 742SF

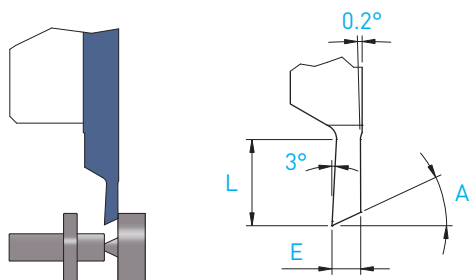

Tronçonnage

Abstechen

Parting off

E	L	A	Art. N°	HTC	HTC-RE	HTAF	HTAF-RE	HTAXF	HTAXF-RE	HTIN	HN (µK10)	XTAF	XTAXF	XTAXF-RE	XN (µK01)
0.5	2.0	25°	741SF-0.5-25°	■	□	■	□	■	□	□	■	■	■	□	□
0.8	3.0	25°	741SF-0.8-25°	■	□	■	□	■	□	□	■	■	■	□	□
1.0	3.0	25°	741SF-1.0-25°	■	□	■	□	■	□	□	■	■	■	□	□
1.2	6.0	22°	741SF-1.2-22°	■	□	■	□	■	□	□	■	■	■	□	□

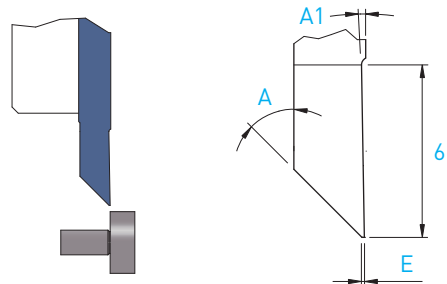

Tournage avant ébauche / finition

Vorwärts drehen schrumpfen / schlichten

Front turning for roughing / finishing

E	A	A1	Art. N°	HTC	HTC-RE	HTAF	HTAF-RE	HTAXF	HTAXF-RE	HTIN	HN (µK10)	XTAF	XTAXF	XTAXF-RE	XN (µK01)
0.03	45°	3°	742SF-3/3-45°	■	■	■	■	■	■	□	■	■	■	□	■
0.08	45°	1°	742SF-8/8-45°	■	■	■	■	■	■	□	■	■	■	□	■

■ = disponible / verfügbar / available

□ = selon disponibilité du stock / jenach Lagerverfügbarkeit / depending on stock availability

7XX-XX-B



Sur demande pour serrage type B, voir page 2.25

Wahlweise für B-Spannsystem, siehe Seite 2.25

On request for B clamping system, see page 2.25

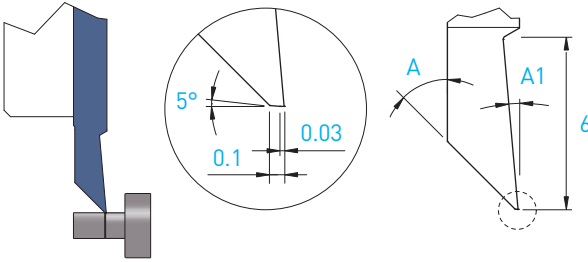

Tournage avant finition  
 Vorwärts drehen schlichten  
 Front turning for finishing

A	A1	Art. N°	HTC	HTC-RE	HTAF	HTAF-RE	HTAXF	HTAXF-RE	HTIN	HN (μK10)	XTAF	XTAXF	XTAXF-RE	XN (μK01)
45°	5°	742SF-10/3	■	■	■	□	□	□	■	■	■	■	□	□

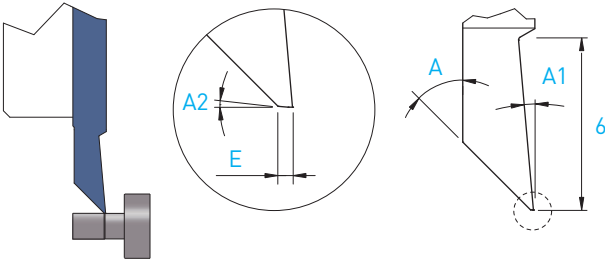

Tournage avant finition  
 Vorwärts drehen schlichten  
 Front turning for finishing

E	A	A1	A2	Art. N°	HTAF-RE	XTAF-RE
0.10	45°	5°	5°	742SF-10/0-5°-45°	■	■
0.15	30°	3°	2°	742SF-15/0-2°-30°	■	■

7XX-XX-B

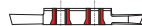

Sur demande pour serrage type B, voir page 2.25  
 Wahlweise für B-Spannsystem, siehe Seite 2.25  
 On request for B clamping system, see page 2.25

Plaquettes d'horlogerie pour machines CNC

Uhrenindustrie-WSP für CNC-Maschinen

Watch industry inserts for CNC machines

R

743SF

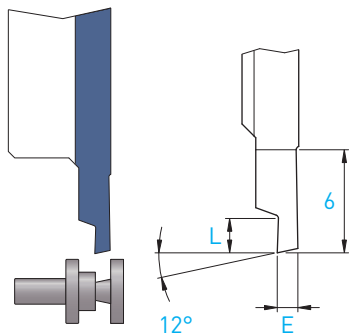

Tournage arrière ébauche  
Rückwärts drehen schrappen  
Back turning for roughing

E	L	Art. N°	HTC	HTAF	HN (µK10)
1.2	2.5	743SF-120/0-12°	■	■	■
1.4	3.0	743SF-140/0-12°	■	■	■
1.6	3.0	743SF-160/0-12°	■	■	■
1.8	4.0	743SF-180/0-12°	■	■	■

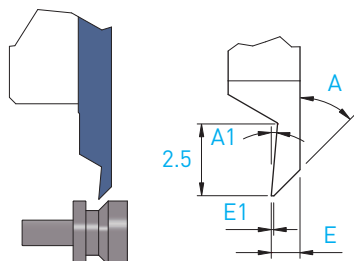

Tournage arrière ébauche/finition  
Rückwärts drehen schrappen/schlichten  
Back turning for roughing/finishing

E1	E	A	A1	Art. N°	HTC	HTC-RE	HTAF	HTAF-RE	HTAXF	HTAXF-RE	HTiN	HN (µK10)	XTAF	XTAXF	XTAXF-RE	XN (µK01)
0.03	1.0	45°	5°	743SF-3/3-45°-1.0	■	■	■	■	■	■	□	■	■	■	■	■
0.03	1.2	45°	5°	743SF-3/3-45°-1.2	■	■	■	■	■	■	□	■	■	■	■	■
0.10	1.0	45°	5°	743SF-10/10-45°-1.0	■	■	■	■	■	■	□	■	■	■	■	■
0.05	0.8	30°	3°	743SF-5/5-30°-0.8			■									
0.05	1.0	30°	3°	743SF-5/5-30°-1.0			■									

7XX-XX-B



Sur demande pour serrage type B, voir page 2.25  
Wahlweise für B-Spannsystem, siehe Seite 2.25  
On request for B clamping system, see page 2.25

■ = disponible / verfügbar / available

□ = selon disponibilité du stock / jenach Lagerverfügbarkeit / depending on stock availability



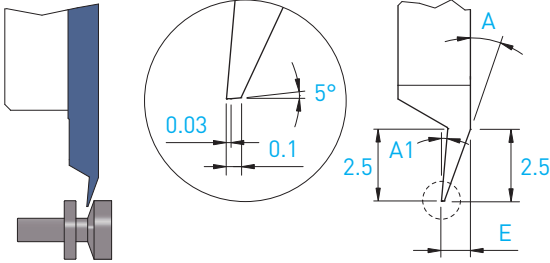

Tournage arrière finition  
 Rückwärts drehen schlichten  
 Back turning for finishing

E	A	A1	Art. N°	HTC	HTC-RE	HTAF	HTAF-RE	HTAXF	HTAXF-RE	HTIN	HN (µK10)	XTAF	XTAXF	XTAXF-RE	XN (µK01)
1.0	20°	5°	743SF-10/3	■	■	■	■	■	■	□	■	■	■	□	□

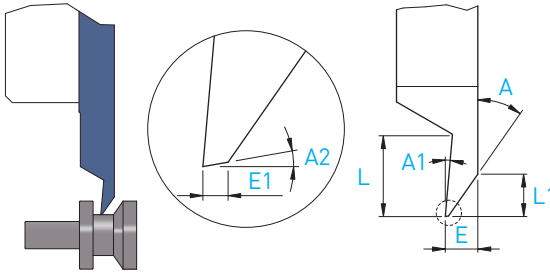

Tournage arrière finition  
 Rückwärts drehen schlichten  
 Back turning for finishing

E1	E	L1	L	A	A1	A2	Art. N°	HTAF-RE	XTAF-RE
0.08	1.0	1.6	2.5	30°	5°	2°	743SF-8/0-2°-30°-1.0	■	■
0.15	1.2	1.8	4.0	30°	3°	2°	743SF-15/0-2°-30°-1.2	■	■
0.10	1.0	1.3	2.5	35°	5°	10°	743SF-10/0-10°-35°-1.0	■	■

7XX-XX-B

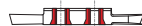

Sur demande pour serrage type B, voir page 2.25  
 Wahlweise für B-Spannsystem, siehe Seite 2.25  
 On request for B clamping system, see page 2.25

Filetage à profil partiel – norme NIHS

Gewinde drehen mit Teilprofil – Norm NIHS

Threading with partial profile – norm NIHS

R/L

746SF / 736SF

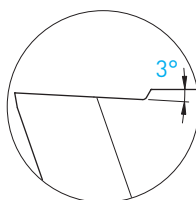
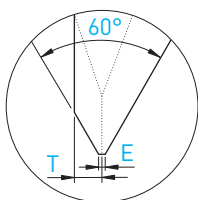
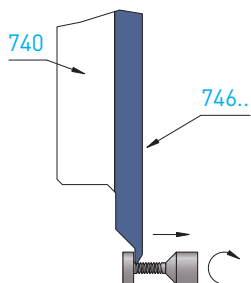

Filetage à droite  
sens rotation machine M3

Rechtgewinde Drehrichtung  
der Maschine M3

Right-hand thread rotating  
machinery M3

Filetage Gewinde drehen Threading	Pas Steigung Pitch P	T	E 0/-0.01	Art. N°	HTAF HN (µK10)
S0.50	0.125	0.07	0.015	746SFX3-A60-S0.50-AR	■ ■
S0.60	0.150	0.09	0.020	746SFX3-A60-S0.60-AR	■ ■
S0.70	0.175	0.10	0.020	746SFX3-A60-S0.70-AR	■ ■
S0.80	0.200	0.12	0.025	746SFX3-A60-S0.80-AR	■ ■
S0.90	0.225	0.13	0.030	746SFX3-A60-S0.90-AR	■ ■
S1.00	0.250	0.15	0.035	746SFX3-A60-S1.00-AR	■ ■

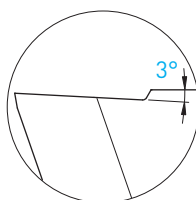
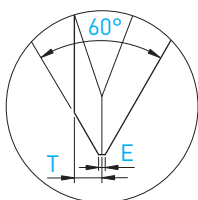
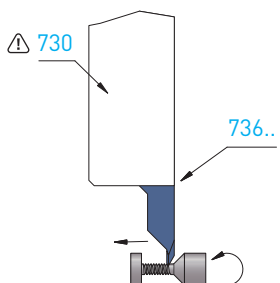

Filetage à droite  
sens rotation machine M4

Rechtgewinde Drehrichtung  
der Maschine M4

Right-hand thread rotating  
machinery M4

Filetage Gewinde drehen Threading	Pas Steigung Pitch P	T	E 0/-0.01	Art. N°	HTAF HN (µK10)
S0.50	0.125	0.07	0.015	736SFX3-A60-S0.50-AR	■ ■
S0.60	0.150	0.09	0.020	736SFX3-A60-S0.60-AR	■ ■
S0.70	0.175	0.10	0.020	736SFX3-A60-S0.70-AR	■ ■
S0.80	0.200	0.12	0.025	736SFX3-A60-S0.80-AR	■ ■
S0.90	0.225	0.13	0.030	736SFX3-A60-S0.90-AR	■ ■
S1.00	0.250	0.15	0.035	736SFX3-A60-S1.00-AR	■ ■

7XX-XX-B



Sur demande pour serrage type B, voir page 2.25  
Wahlweise für B-Spannsystem, siehe Seite 2.25  
On request for B clamping system, see page 2.25

■ = disponible / verfügbar / available  
□ = selon disponibilité du stock / jenach Lagerverfügbarkeit / depending on stock availability

# TOP-WATCH

Plaquettes piqure avant

Frontestich WSP

Front grooving inserts

R

748SF

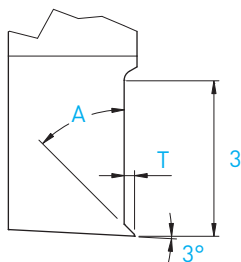
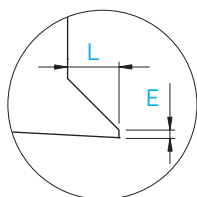
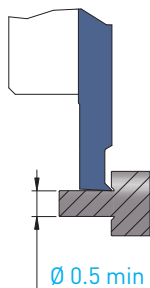

$E_{0/-0.01}$	A	T	Art. N°	HTC	HTC-RE	HTAF	HTAF-RE	HTIN	HN ( $\mu\text{K}10$ )
0.03	45°	0.2	748SF-E03-A45°-L20	■	■	■	■	□	■
0.05	45°	0.3	748SF-E05-A45°-L30	■	■	■	■	■	■
0.08	45°	0.5	748SF-E08-A45°-L50	■	■	■	■	□	■

Plaquettes piqure arrière

Rückestich WSP

Back grooving inserts

R

749SF

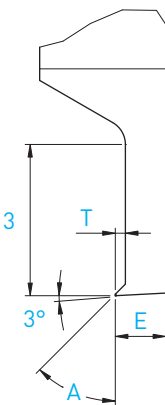
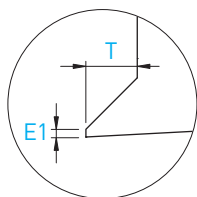
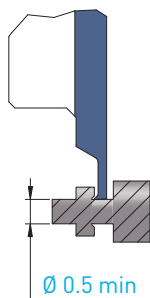

$E1_{0/-0.01}$	A	T	E	Art. N°	HTC	HTC-RE	HTAF	HTAF-RE	HTIN	HN ( $\mu\text{K}10$ )
0.03	45°	0.2	1.0	749SF-E03-A45°-L20-B100	■	■	■	■	□	■
0.05	45°	0.3	1.0	749SF-E05-A45°-L30-B100	■	□	■	■	□	■
0.08	45°	0.5	1.2	749SF-E08-A45°-L50-B120	■	■	■	■	□	■

7XX-XX-B



Sur demande pour serrage type B, voir page 2.25  
Wahlweise für B-Spannsystem, siehe Seite 2.25  
On request for B clamping system, see page 2.25

Plaquettes ébauches

WSP-Rohlinge

Blank inserts

L/R

731-ESF / 741-ESF

L

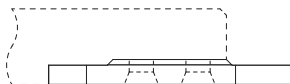
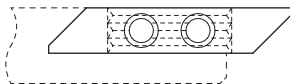

R

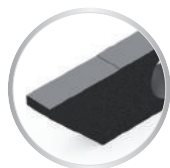
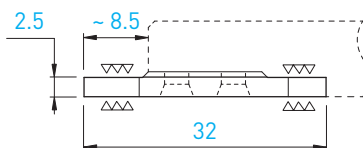
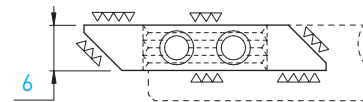

L				R													
Art. N°	HTC	HTAF	HTAXF	HTIN	HN (μK10)	XTC	XTAF	XN (μK01)	Art. N°	HTC	HTAF	HTAXF	HTIN	HN (μK10)	XTC	XTAF	XN (μK01)
731-ESF	■	■	■	■	■	■	■	■	741-ESF	■	■	■	■	■	■	■	■

7XX-XX-B



Sur demande pour serrage type B, voir page 2.25  
 Wahlweise für B-Spannsystem, siehe Seite 2.25  
 On request for B clamping system, see page 2.25

■ = disponible / verfügbar / available  
 □ = selon disponibilité du stock / jenach Lagerverfügbarkeit / depending on stock availability

Porte-outils

Halter

Holder

Coupe à droite déportée

Versetztes Rechtsschneiden

Right cut off line

## 730RC / 750RC

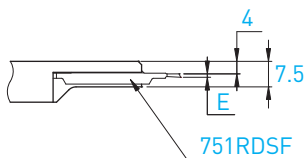
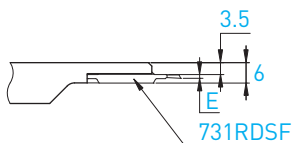
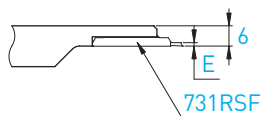
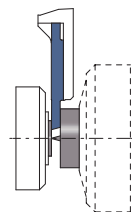

### L (R)

Coupe à droite déportée  
Versetztes Rechtsschneiden  
Right cut off line



A x B	L	L1	Art. N°
8 x 8	115	24	<b>730RC-8</b>
10 x 10	115	24	<b>730RC-10</b>
12 x 12	130	30	<b>730RC-12</b>
16 x 16	130	40	<b>730RC-16</b>

A x B	L	L1	Art. N°
12 x 12	130	30	<b>750RC-12</b>
16 x 16	130	40	<b>750RC-16</b>

Tronçonnage  
Abstechen  
Parting off

Coupe à droite déportée  
Versetztes Rechtsschneiden  
Right cut off line

731R / 751R

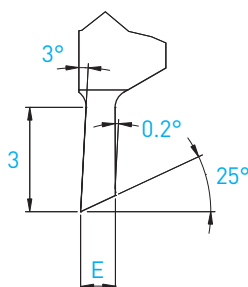
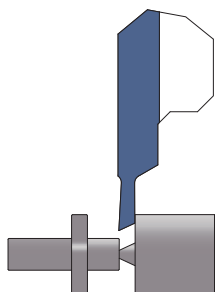

**L (R)**  
Coupe à droite déportée  
Versetztes Rechtsschneiden  
Right cut off line

E	Art. N°	HTAF	HTIN	HN (µK10)
1.0	731RSF-1.0-25°	■	■	■

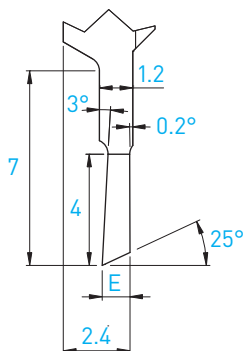
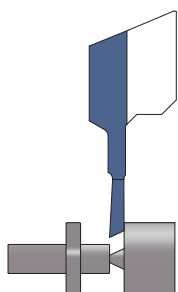

**L (R)**  
Coupe à droite déportée  
Versetztes Rechtsschneiden  
Right cut off line

E	Art. N°	HTAF	HTIN	HN (µK10)
0.8	731RDSF-0.8-25°	■	■	■
1.0	731RDSF-1.0-25°	■	□	■

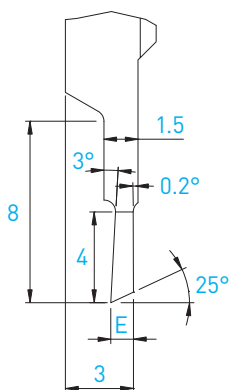
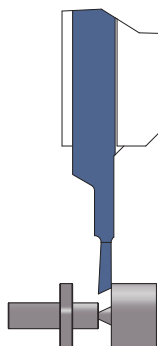

**L (R)**  
Coupe à droite déportée  
Versetztes Rechtsschneiden  
Right cut off line

E	Art. N°	HTAF	HTIN	HN (µK10)
0.8	751RDSF-0.8-25°	■	■	■
1.0	751RDSF-1.0-25°	■	□	■

■ = disponible / verfügbar / available  
□ = selon disponibilité du stock / jenach Lagerverfügbarkeit / depending on stock availability

Porte-outils

Halter

Holders

SwissNANO 4

770-SN4-SF

**new**

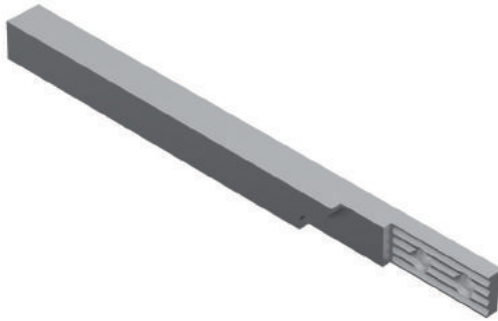
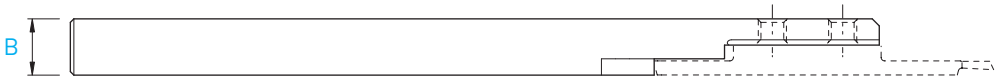
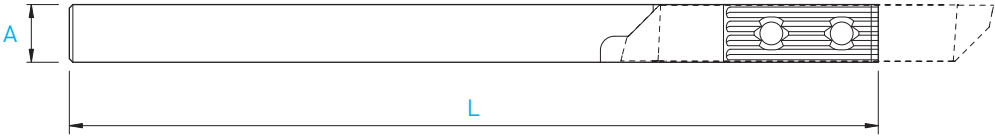

**L (R)**

Coupe à droite déportée  
Versetzttes Rechtsschneiden  
Right cut off line

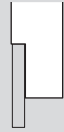

A x B	L	Art. N°
8.2 x 8	115	770-8.2X8-SN4-SF

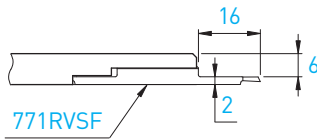
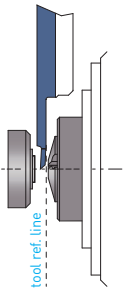

771RVSF

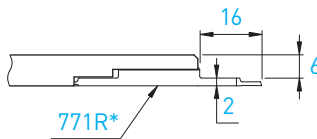
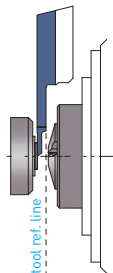

771R\*

\* voir TOP-Line  
\* siehe TOP-Line  
\* see TOP-Line

Porte-outils

Halter

Holders

SwissNANO 7

770-SN7-SF

new

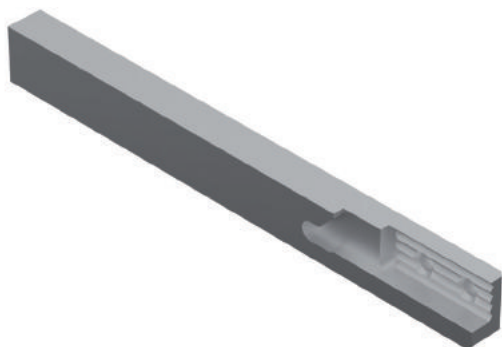
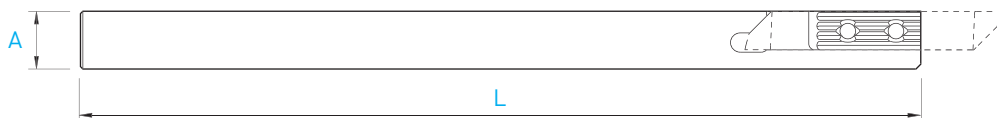

L (R)

Coupe à droite déportée  
Versetzttes Rechtsschneiden  
Right cut off line



A x B	L	Art. N°
12 x 8	115	770-12X8-SN7-SF

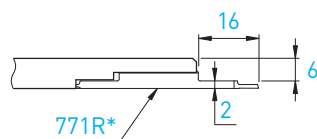
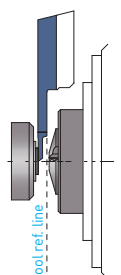
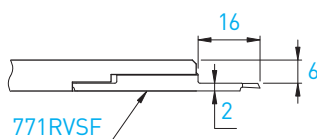
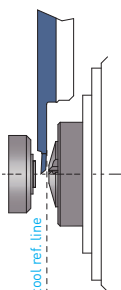

\* voir TOP-Line  
\* siehe TOP-Line  
\* see TOP-Line



Plaquette

Wendplatte

Insert

Coupe à gauche déportée

Versetztes Linksschneiden

Left cut off line

**new**

## 771RVSF

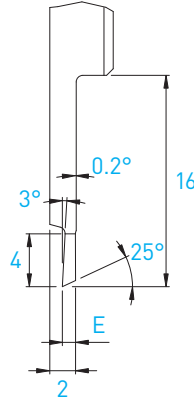
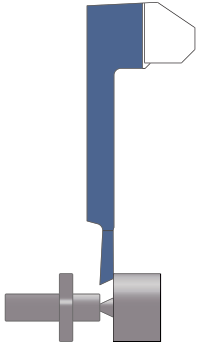

R (L)

Coupe à gauche déportée  
Versetztes Linksschneiden  
Left cut off line

E	Art. N°	TAF	N (µK20)
1.0	771RVSF-1.0-25°	■	■
1.2	771RVSF-1.2-25°	■	■
1.5	771RVSF-1.5-25°	■	■

Porte-outils spéciaux de tronçonnage

Sonder Abstechwerkzeughalter

Special parting off tool holders

## MODU-LINE

## ML12

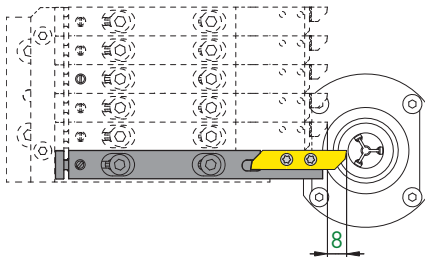

Type de machine Maschinen-Typ Type of machine	Porte-outils Halter Holders	Art. N°	Plaquettes type WSP Typ Inserts type
SwissNano	ML12	<b>ML12A-730RC-SWISS-NANO</b>	731RSF / 731RDSF
SwissNano	ML12	<b>ML12A-750RC-SWISS-NANO</b>	751RDSF

Voir documentation MODU-Line  
Siehe MODU-Line Dokumentation  
See MODU-Line documentation

L'outil de référence pour le décolletage

Hochwertiges Wendeplattensystem für Langdrehautomaten

Top class turning tool for automatic lathes

700 Series

## 100% rigid!

Système de serrage Applitec à denture décalée  
 Applitec-Spannsystem mit verschobener Verzahnung  
 Applitec clamping system with shifted teeth

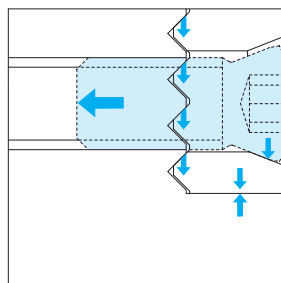
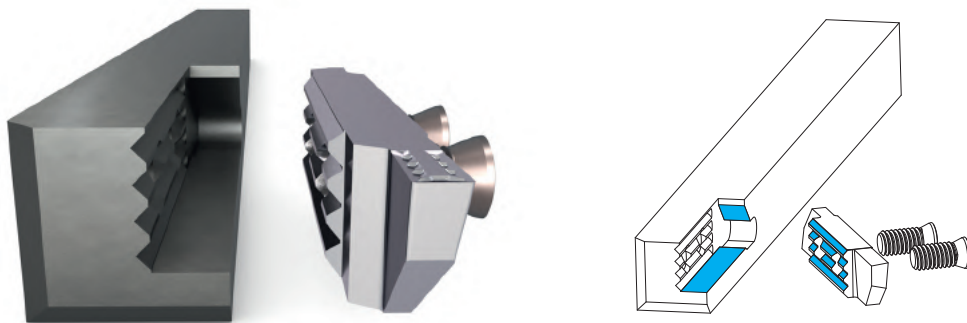

**Serrage standard (A)**  
**Standard Spannsystem (A)**  
**Standard clamping system (A)**

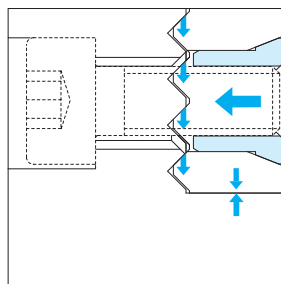
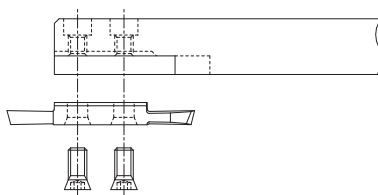

**Serrage type B\***  
**Spannsystem Typ B\***  
**Clamping system type B\***

ajouter -B après le numéro d'article  
 -B nach der Artikelreferenz hinzufügen  
 add -B after the article number

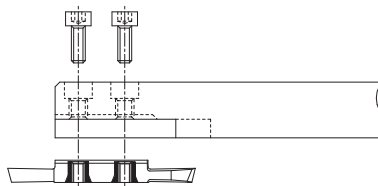

Changement de la plaquette possible dans la machine, sans démontage du porte-outil  
 WSP-Austauschmöglichkeit in der Maschine ohne Halterausbau  
 The insert can be changed in the machine without removing the tool holder